

DESCRIPTION AND EVALUATION OF THE EFFECTS OF URBAN  
AND AGRICULTURAL DEVELOPMENT ON THE SURFICIAL  
AQUIFER SYSTEM, PALM BEACH COUNTY, FLORIDA

By Wesley L. Miller

---

U.S. GEOLOGICAL SURVEY

Water-Resources Investigations Report 88-4056

Prepared in cooperation with  
PALM BEACH COUNTY



Tallahassee, Florida

1988

DEPARTMENT OF THE INTERIOR  
DONALD PAUL HODEL, Secretary  
U.S. GEOLOGICAL SURVEY  
Dallas L. Peck, Director

---

For additional information  
write to:

District Chief  
U.S. Geological Survey  
Suite 3015  
227 North Bronough Street  
Tallahassee, Florida 32301

Copies of this report can be  
purchased from:

U.S. Geological Survey  
Books and Open-File Reports Section  
Federal Center, Building 810  
Box 25425  
Denver, Colorado 80225

CONTENTS

	Page
Abstract-----	1
Introduction-----	2
Purpose and scope-----	4
Previous investigations-----	5
Acknowledgments-----	6
Description of surficial aquifer system-----	6
Geology-----	9
Water use-----	10
Effects on ground-water levels and flow directions-----	14
Predevelopment conditions-----	14
Canal development-----	14
Ground-water levels and fluctuations since 1970-----	16
Ground-water flow directions-----	19
Ground-water quality-----	22
Effects on area of highly mineralized ground water-----	23
Effects of ground-water/surface-water exchange on water quality in the surficial aquifer system-----	33
West Palm Beach and Levee L-8 Canals-----	36
Hillsboro, North New River, and Miami Canals-----	39
Lake Worth Drainage District canals-----	43
Summary-----	45
Selected references-----	48

ILLUSTRATIONS

Figures 1-8. Maps showing:

1. Location of Palm Beach County, Florida-----	3
2. Location and boundaries of zones I, II, and III of the surficial aquifer system in Palm Beach County-----	7
3. Location of public supply utilities and public supply areas, Palm Beach County-----	11
4. Physiographic features of Palm Beach County-----	15
5. Altitude of water table, surficial aquifer system, Palm Beach County, April 1984-----	17
6. Altitude of water table, surficial aquifer system, Palm Beach County, November 1984-----	18
7. Average ground-water flow directions in the surficial aquifer system, Palm Beach County, 1970 to 1981 and 1984-----	20
8. Ground-water and surface-water sampling sites in Palm Beach County-----	24

ILLUSTRATIONS--Continued

	Page
Figures 9-12. Maps showing chloride concentrations of:	
9. Water in (a) wells as much as 20 feet deep, (b) wells 20 to 50 feet deep, and (c) wells 51 to 100 feet deep in the surficial aquifer system, Palm Beach County, 1941-43-----	27
10. Water at depths as much as 20 feet in the surficial aquifer system, Palm Beach County, 1983-84-----	28
11. Water at depths of 20 to 50 feet in the surficial aquifer system, Palm Beach County, 1983-84-----	29
12. Water at depths of 51 to 100 feet in the surficial aquifer system, Palm Beach County, 1983-84-----	30
13-18. Stiff diagrams showing chemical composition of:	
13. Ground water and surface water in Palm Beach County, April 1984-----	35
14. Water in West Palm Beach and Levee L-8 Canals and nearby wells, April 1984-----	37
15. Water in Hillsboro Canal and nearby wells, April 1984-----	40
16. Water in North New River Canal and nearby wells, April 1984-----	41
17. Water in Miami Canal and nearby wells, April 1984-----	42
18. Water in Lake Worth Drainage District E-1 Canal and nearby wells, April 1984-----	44

TABLES

Table 1. Total ground-water and surface-water withdrawals by public supply utilities in Palm Beach County, 1978-83-----	12
2. Map, local, and identification numbers of wells sampled for water quality, the surficial aquifer system zone in which they are located, and their depth-----	25
3. Map, local, and identification numbers of surface-water sites sampled for water quality and the surficial aquifer system zone in which they are located-----	26

TABLES--Continued

	Page
Table 4. Concentrations of major inorganic constituents and related chemical characteristics of ground water-----	52
5. Chloride concentrations at selected wells in the surficial aquifer system, Palm Beach County, October 1983 through November 1984-----	55
6. Concentrations of major inorganic constituents and related chemical characteristics of surface water-----	56
7. Chloride concentrations in samples collected during test well drilling, Palm Beach County, September and October 1983-----	58

DESCRIPTION AND EVALUATION OF THE EFFECTS OF URBAN AND AGRICULTURAL  
DEVELOPMENT ON THE SURFICIAL AQUIFER SYSTEM, PALM BEACH COUNTY, FLORIDA

By Wesley L. Miller

ABSTRACT

The surficial aquifer system in Palm Beach County was studied during 1982-85 to determine the effects of increased urban and agricultural development on ground-water levels, flow directions, and quality. Data used included: lithologic logs, periodic water-level measurements at wells and surface-water sites, water-quality analyses for major inorganic ions in ground water and surface water, and water withdrawals by public supply utilities during 1978-83. The surficial aquifer system and its geologic matrix are divisible into three zones on the bases of relative permeabilities and lithologic characteristics. Zone I, the most permeable, was developed along a coastal Pliocene reef tract and is characterized by solution cavities. Zone II, somewhat less permeable, was formed by wave action and flowing water and lacks solution cavities. Zone III, the least permeable, was formed in a basin environment of shallow seas, lakes, and marshes.

The two greatest water users in the county, public supply utilities and agricultural irrigators, increased total water withdrawals by 123 and 50 percent, respectively, during 1970-80. By 1980, 76 percent of public supply withdrawals were from zones I and II of the surficial aquifer system, whereas ground-water pumpage for irrigation decreased to 9 percent of the total irrigation water used. Increases in ground-water withdrawals for public supply were greatest in the southeast and central coastal parts of the county and served as an indicator for potential changes of flow directions and water quality in the surficial aquifer system.

Construction of primary canals in the early 1900's for drainage and flood control had large initial effects on countywide ground-water levels, but more recent use of the enlarged canal network to regulate canal and ground-water levels has greatly reduced water-table fluctuations. Water-table maps of 1970-81 show minimal fluctuations even though ground-water use more than doubled. Ground-water level measurements during two dry-wet season cycles, 1983-85, indicated average fluctuations of less than 2 feet in both urban and agricultural areas. Comparison of average ground-water flow directions during 1970-81 with those of 1984 indicated changes attributable to increased withdrawals in urban areas.

Residual seawater, emplaced in the aquifer system during the Pleistocene Epoch, is still prevalent in the central and western parts of Palm Beach County where low permeabilities in the geologic matrix have retarded its dilution. Between 1943 and 1983, upward migration of this water has increased chloride concentrations and the size of affected areas in ground water surveyed at three depth intervals--as much as 20 feet, 20 to 50 feet, and 51 to 100 feet. Chemical analyses of canal-water and ground-water samples collected in April 1984 were used to evaluate the effects of ground-water/surface-water

exchange on the quality of water during canal conveyance across the area containing residual seawater. Water in the West Palm Beach, Levee L-8, and Hillsboro Canals became more highly mineralized during conveyance than ground water in the eastern part of the county. Along the North New River and Miami Canals, which do not cross more permeable aquifer system zones within the county, mineral content in the canal water decreased as it flowed downstream. However, data from other samplings along these two canals indicated that mineral concentrations had increased. Water released from Conservation Area No. 1 to the Lake Worth Drainage District canals was less mineralized than that of the adjacent surficial aquifer system and posed no potential threat of increased mineral concentrations in the ground water.

## INTRODUCTION

Demands for freshwater in Palm Beach County, Fla. (fig. 1), have rapidly increased during recent years in response to population growth, urban development in the eastern part of the county, and intensive agricultural expansion in the central and western areas. Between 1970 and 1980, the county's population increased 65 percent from 348,933 to 576,863 (University of Florida, 1981a, p. 330). During that time, water-use estimates for public supply increased by more than 123 percent (Pride, 1972, p. 18; Miller and Alvarez, 1984, p. 14), and water-use estimates for agriculture increased by about 78 percent (Pride, 1972, p. 40; Leach, 1982, p. 177). These data indicate the steadily increasing dependence of public supplies on ground-water sources, which accounted for 64 percent of the pumpage for public supplies in 1970 and 76 percent of the pumpage in 1980. Conversely, agricultural water use, primarily for irrigation, had become increasingly dependent on surface water, which accounted for 70 percent of the pumpage for agriculture in 1970 and 91 percent of the pumpage in 1980. The ever-increasing demands for freshwater have emphasized the necessity for improved understanding of natural and man-made factors that affect the water resources of the area to ensure continued availability of water throughout the county.

The increasing dependence on ground water for public supply and surface water for agricultural irrigation reflects changing land-use patterns in the county (Palm Beach County Department of Planning, Building, and Zoning, 1980, p. 6-7). Urbanization along the coast, where ground-water quality is suitable for most uses (Swayze and Miller, 1984, p. 24), is rapidly displacing agriculture and is increasing demands for public supply water. Agriculture in central and western Palm Beach County relies almost totally on surface water for irrigation because of highly mineralized ground water in the area (Parker and others, 1955, p. 185), low yields of water to wells (Harrison and others, 1982, p. 1), and close proximity to Lake Okeechobee and major canals (fig. 1), which are readily available water sources.

The greatest concern in Palm Beach County is the continued availability of ground water of usable quality from the surficial aquifer system. High mineralization of the water in the deeper Floridan aquifer (Shampine, 1975) makes the surficial aquifer system the only source of potable ground water available for public and private water supplies within the county. Increased withdrawals from the surficial aquifer system to meet water demands for public

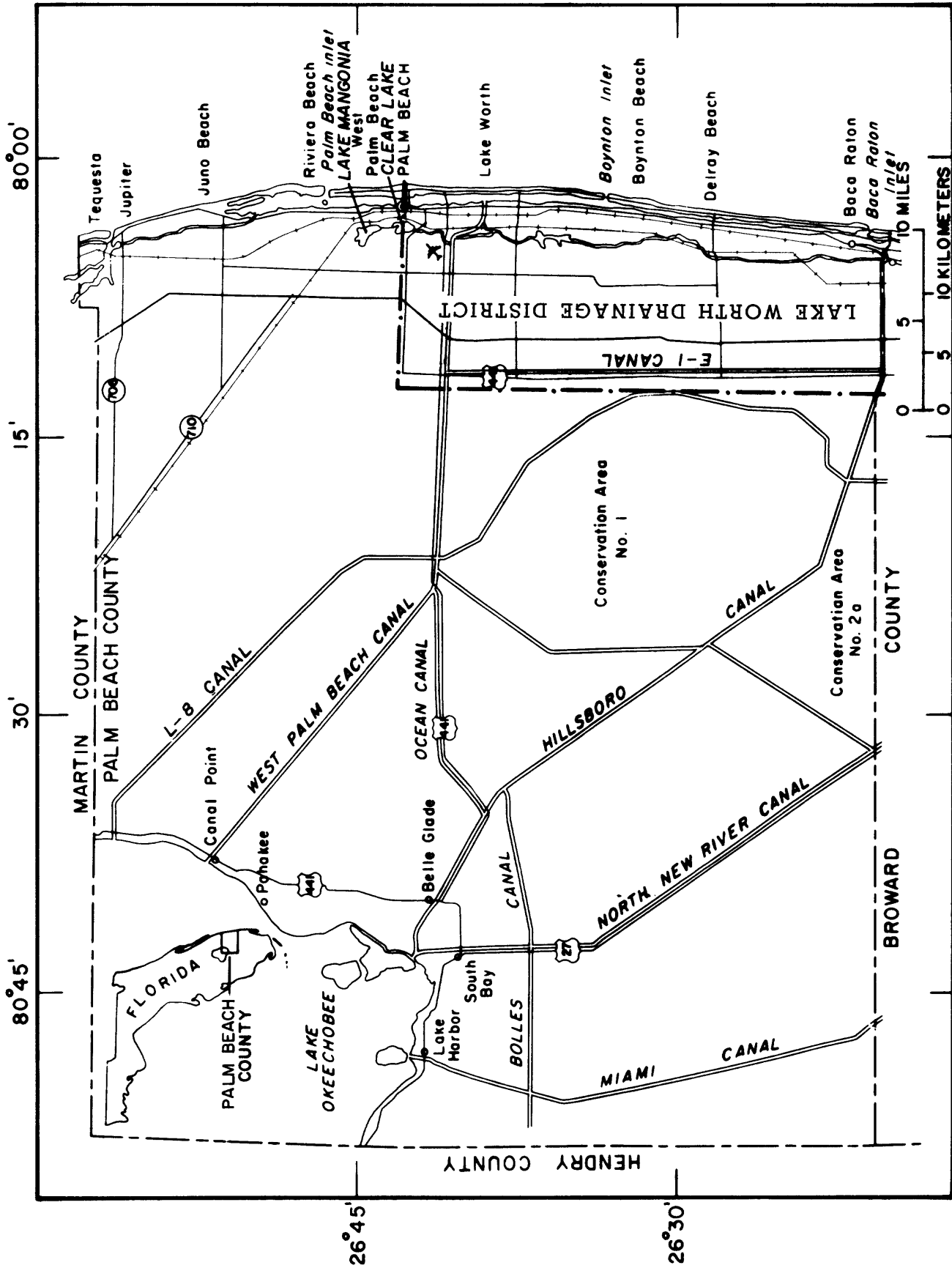

Figure 1.--Location of Palm Beach County, Florida.



supply in the coastal areas have altered ground-water flow patterns and magnified the potential for highly mineralized ground water to migrate eastward toward urban areas and their well fields. Eastward movement of the highly mineralized water is possible both in the aquifer system and in canals, such as the West Palm Beach, Levee L-8, and Hillsboro Canals (fig. 1). These canals are used to convey water from Lake Okeechobee to recharge coastal well fields. Highly mineralized ground water and agricultural runoff enter the canal system in the predominantly agricultural central and western parts of the county; here, networks of ditches connected to the primary canals are alternately used to drain the land, partially dewater the surficial aquifer system, and supply water for irrigation depending upon climatic conditions. Much of the water conveyed in the primary canals eventually infiltrates to the aquifer system in the more permeable components near the coast (Swayze and Miller, 1984, p. 2).

### Purpose and Scope

This report describes the results of an investigation designed to evaluate the effects of urban and agricultural development on the surficial aquifer system within the 1,978-mi<sup>2</sup> area of Palm Beach County. Objectives of the 3-year cooperative effort of the U.S. Geological Survey and Palm Beach County, which began in 1982, were to:

- Evaluate the effects of increased withdrawals from the surficial aquifer system on ground-water levels and flow patterns;
- Delineate the area of highly mineralized (saline) remnant seawater in central and western Palm Beach County and determine the extent of the water's eastward migration in the aquifer system;
- Determine the effects of increased ground-water withdrawals and agricultural water-management practices on the degree of mineralization in the aquifer system and canals within the county; and
- Describe the geologic framework of the aquifer and its effects on the hydrologic system.

The scope of the work required to achieve the above objectives and reported herein included the following:

- Geologic and hydrologic histories of the area were gleaned from previous studies relating to the area. The data were used as a basis upon which to identify data needs and to interpret current data collected during the investigation.
- Geologic test wells, ranging in depth from 44 to 220 feet, were drilled and lithologic logs prepared at 33 sites for correlation with existing lithologic and geophysical logs of 112 wells (Schneider, 1976, 99 p.; Swayze and others, 1981, 93 p). The data were used to define the surficial aquifer system and its geologic framework and to aid in selection of data-collection sites.

- Ground-water and surface-water levels, corrected to sea level, were measured semiannually at 110 wells and 25 canals in the county. Measurements were made at the end of the dry season (November to April) and at the end of the wet season (May to October) to determine the altitude of the water table and ground-water flow directions in the aquifer system.
- Water samples were collected semiannually from 57 wells, ranging in depth from 17 to 220 feet, and 25 surface-water sites. Chemical determinations for major inorganic ions, dissolved solids, and hardness were made at the U.S. Geological Survey Laboratory in Ocala, Fla. Samples for chloride concentration analyses were also collected from an additional 37 wells, ranging in depth from 9 to 201 feet. During drilling of 27 geologic test wells, reverse air drilling equipment made possible collection of water samples that were uncontaminated by drilling mud, at 10-foot intervals for analyses of chloride concentrations. These data and historical data were evaluated to determine areal and vertical variations in water quality and long-term changes in the ionic character of the aquifer system water.
- Monthly and yearly ground-water and surface-water withdrawals from the hydrologic system by 32 major public supply utilities in Palm Beach County during 1983 were compiled for comparison to historical water-use data (Miller and Alvarez, 1984, 14 p). These data were used to identify areas of major withdrawals from the aquifer system and to determine long-term changes in withdrawals.

Data-collection sites and the types of data collected were based largely on the availability of historical data and knowledge from previous investigations. The data-collection networks used for this investigation were initially limited to historical data-collection sites in the coastal areas where data were abundant. The networks were subsequently expanded into the central and western parts of Palm Beach County where little information was available. The location of additional data-collection sites and the types of data to be collected were determined after evaluation of current and historical data.

#### Previous Investigations

Many U.S. Geological Survey reports with direct application to this investigation have been published as result from previous studies in Palm Beach County and south Florida. General information about the hydrology and geology of the region was provided by Parker and others (1955). Countywide investigations by Schroeder and others (1954), Rodis and Land (1976), and Scott (1977) are more comprehensive overviews of ground-water and surface-water quality, aquifer hydraulics, and geology. More localized investigations such as McCoy and Hardee (1970), Land and others (1973), Rodis (1973), Fischer (1980), and Swayze and Miller (1984) address the hydrology and geology of specific parts of the county.

### Acknowledgments

The author is indebted to many people whose assistance made this report possible. Instrumental in the initial investigative program design and its subsequent day-to-day implementation were Herbert F. Kahlert, Palm Beach County Engineer; John H. Burns, Palm Beach County Solid Waste Authority; and Ronald L. Day, Palm Beach County Mosquito Control Division. Information about agricultural water-management practices and crop water requirements in central and western Palm Beach County were provided by Joseph R. Orsenigo, Florida Sugar Cane League, Inc. Appreciation is expressed to the landowners who permitted wells and other data-collection sites to be constructed on their property.

### DESCRIPTION OF SURFICIAL AQUIFER SYSTEM

The surficial aquifer system (fig. 2) in Palm Beach County is comprised of many components which may be differentiated by variations in lithology and relative hydraulic characteristics. The components include numerous discontinuous confining units that reflect varying stratigraphic facies. The countywide aquifer system is unconfined (under water-table conditions) and constitutes one of the area's major sources of freshwater. The aquifer system's thickness is defined as the distance between the water table, near land surface, and the base which ranges to depths of more than 300 feet below sea level. The average thickness of the aquifer system in the county, determined from previous lithologic logs (Schneider, 1976; Swayze and others, 1981) and currently acquired lithologic logs, is about 200 feet.

Previous investigations have referred to the surficial aquifer system or its components by various names or terms. Among these is "shallow aquifer," generally applied countywide (Land and others, 1973, p. 7). Later investigations referred to the "cavity-riddled sandy limestone" as "the most permeable part of the shallow aquifer" (Rodis and Land, 1976, p. 6), which was subsequently identified as a "discontinuous zone of secondary permeability in the surficial aquifer" (Swayze and Miller, 1984, p. 8). This part of the aquifer system, locally known as the "Turnpike aquifer," was also recognized as the northernmost extension of the Biscayne aquifer previously identified in the vicinity of Boca Raton by Klein and Hull (1978, p. 3-8).

As the many hydrogeologic components are hydraulically connected, it is herein identified as the surficial aquifer system. Also, herein the components of the aquifer system are broadly grouped into three zones (fig. 2) on the bases of relative permeabilities and lithologic characteristics.

Zone I is the most permeable part of the surficial aquifer system and is synonymous with the "zone of secondary permeability," previously delineated by Swayze and Miller (1984, p. 8-9). Transmissivities in this zone range from 1,000 ft<sup>2</sup>/d along its flanks to 100,000 ft<sup>2</sup>/d along its axis (Swayze and Miller, 1984, p. 20). The definitive characteristic of zone I is the presence of well-developed solution cavities in fossiliferous limestones and calcareous sandstones generally coincident with Pliocene-Pleistocene reef tracts. Materials deposited there were relatively permeable having high primary porosity, contained large amounts of materials susceptible to solution, and formed a

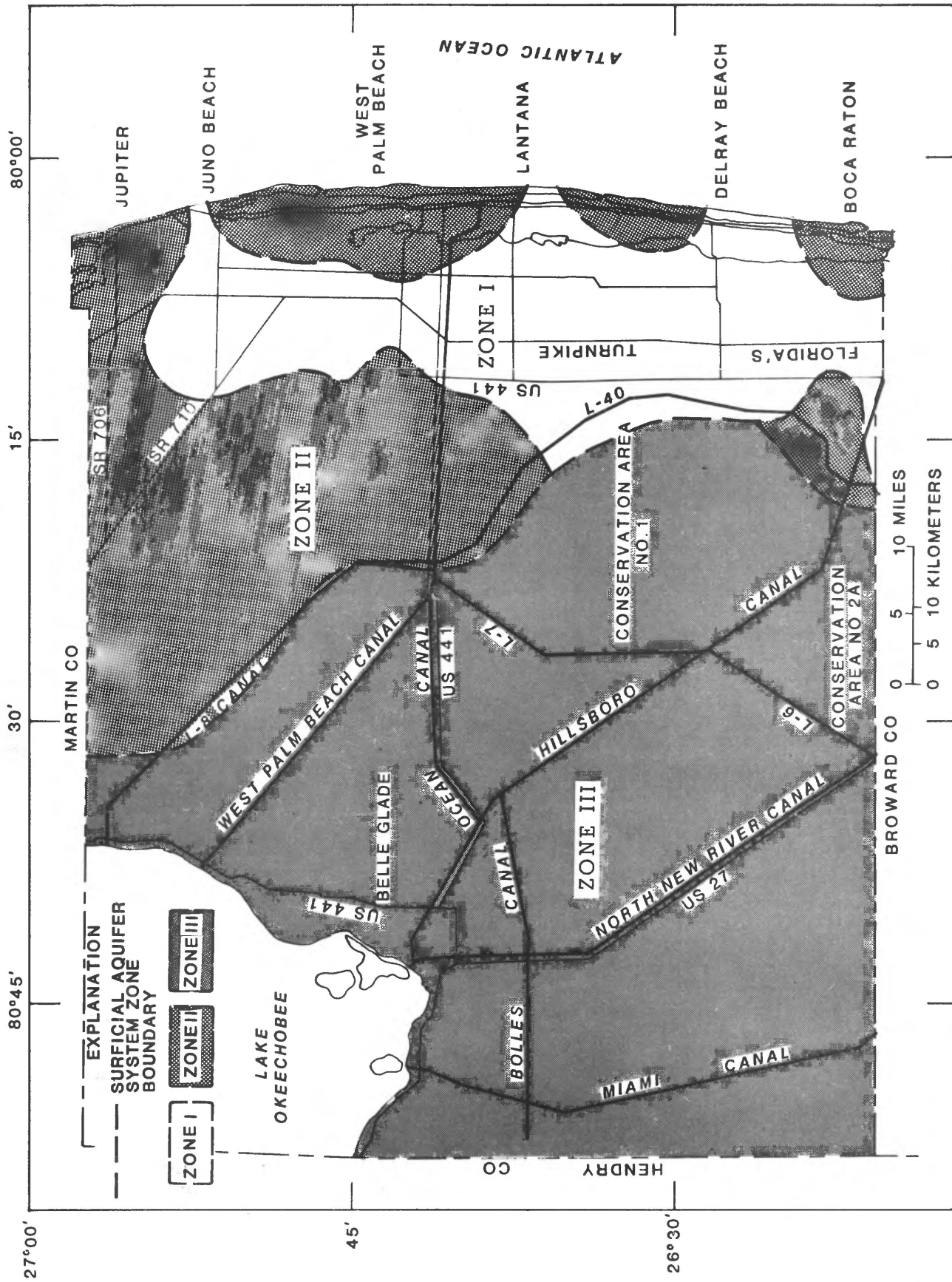

Figure 2.--Location and boundaries of zones I, II, and III of the surficial aquifer system in Palm Beach County.

topographic high in the area. When sea levels were lowered, during and since the Pleistocene, the area was periodically exposed above the water, and dissolution of some of the materials began. The resultant higher permeabilities from this secondary porosity are vertically and horizontally discontinuous because of nonhomogeneity of the material and varying amounts of time the materials were exposed to infiltrating rain water during the gradual fluctuations of sea level. Elsewhere, the aquifer system was insulated from development of secondary porosity by near continuous inundation, less soluble materials, and low primary porosity which inhibited infiltration. The zone extends northward along the coast from Broward County to near Juno Beach (fig. 2).

Zone II of the surficial aquifer system is generally less permeable than zone I. Transmissivities in this zone are somewhat lower than those of zone I and, from limited available information, are similar to the average transmissivity of 5,360 ft<sup>2</sup>/d in the vicinity of Jupiter (Adair and Brady, Inc., 1975, p. 13). Well-sorted poorly consolidated sands and shell and the absence of solution cavities characterize this zone. The predominant sand shell lithology (Schneider, 1976; Swaye and others, 1981) with moderate to good sorting, coupled with the zone's locations (fig. 2), suggests the component was deposited in gaps in the Pliocene reef tract or in beach type deposits. Water moving between the Atlantic Ocean and the Everglades basin during Pleistocene sea-level fluctuations and accompanying wave action increased sorting of the materials, thereby increasing this zone's permeability. The absence of well-defined secondary porosity probably is because of the large proportion of quartz sand in this part of the aquifer system and the relatively brief time the materials have been exposed above sea level. Limited amounts of materials readily susceptible to dissolution and limited exposure to infiltrating water have retarded development of secondary porosity. The discontinuous zone is along the flanks of zone I.

Zone III is the least permeable part of the aquifer system. Although transmissivity estimates are not available, hydraulic conductivities determined by Scott (1977, p. 12-15) suggest they are very low throughout the zone. Lithologic characteristics of zone III include poorly sorted to unsorted sediments with large amounts of clay-size particles and nearly impermeable marls at varying depths. These materials were deposited in low-energy environments, ranging from shallow seas to freshwater lakes and marshes. Unconformable surfaces between the major formations act as confining units and indicate long erosional and nondepositional events during major glaciations. The glaciations lowered sea levels and reduced atmospheric moisture sufficiently for the basin to become dry. The low-lying area, 8 to 12 feet above sea level, has not developed secondary porosities because of low ground-water gradients (Miller, 1985a; 1985b), low primary porosity, and nearly impermeable marls which almost totally prevent infiltration of surface water in most of the area. Zone III extends throughout most of the central and western parts of the county (fig. 2).

## Geology

Hydrologic characteristics of the surficial aquifer system in Palm Beach County were initially controlled by the geologic materials which comprise the framework of the aquifer system. The aquifer system is comprised of geologic materials deposited primarily during the Pliocene and Pleistocene Epochs, with Holocene materials included in the uppermost part of the aquifer system in some areas (Parker and others, 1955, p. 64). Limestones, sands, shells, silts, calcareous clays (marls), and varying mixtures of these materials form the matrix of the aquifer system. The boundaries of the aquifer system and its zones were defined by relative permeabilities of the matrix materials. Sediment reworking, dissolution, induration, and depositional environment frequently altered originally deposited materials, accentuating a variation of permeabilities in the aquifer system.

The geologic formations and units found in the aquifer system are the Tamiami Formation and the Buckingham Formation as first defined by Mansfield (1939, p. 8), the Caloosahatchee Marl (Matson and Clapp, 1909, p. 123), the Fort Thompson Formation (Cooke and Mossom, 1929, p. 211-215), the Anastasia Formation (Sellards, 1912, p. 7), the Miami Oolite (Sanford, 1909, p. 211-214), the Pamlico Sand (Parker and Cooke, 1944, p. 75), and the Lake Flirt Marl (Sellards, 1919, p. 73). The Buckingham Formation has more recently been designated a member of the Tamiami Formation (Brooks, 1981), and because of shared index faunal assemblages has been referred to as the "Florida Duplin marl" (Cooke, 1945, p. 182). These formations and units were originally identified in type localities elsewhere in Florida and later recognized in Palm Beach County by many investigators, most notably Parker and others (1955, p. 57-111).

Most of the formations and units are currently assigned to the Pleistocene Epoch, except for the Tamiami Formation (Pliocene), the Caloosahatchee Marl (Pliocene and Pleistocene), and the Lake Flirt Marl (Pleistocene and Holocene). The boundaries and geologic ages of the units have previously been determined using faunal assemblages from the type locality and updates, such as that of Gardner (*in* Parker and others, 1955, p. 72-80). More recent paleontologic research in south Florida (Petuch, 1982, p. 12-30) has provided greater faunal definition of the formations, but because of disparities in existing information, their delineation is beyond the scope of this investigation.

Impermeable and semipermeable calcareous clays of the Hawthorn Formation (Miocene) and, in some areas, the Caloosahatchee Marl and Tamiami Formation, unconformably underlie the aquifer system and form its base. Geologic samples obtained during test-well drilling indicate that, in some areas, the aquifer system base was formed by extensive erosion of Miocene and Pliocene sediments and deposition of the reworked sediments. For a more complete description of the lithology of the aquifer system and its base, see Miller (1986).

## WATER USE

Water withdrawals from the surficial aquifer system for various uses may be a barometer of potential changes in ground-water flow directions and quality. The two greatest users of freshwater in Palm Beach County are public supply utilities and agricultural irrigation. Water-use estimates by Pride (1972) and Leach (1982) show that between 1970 and 1980 public supply withdrawals increased from 20,184.50 to 45,193.80 Mgal, and agricultural irrigation withdrawals increased from 149,577.00 to 224,193.95 Mgal. Water-use estimates for 1975 and 1977 (Leach, 1978; Leach and Healy, 1979) indicate that water use in these two categories consistently increased throughout the decade.

During 1970-80, public supplies became increasingly dependent upon ground water from the surficial aquifer system, whereas agricultural irrigation became more dependent upon surface water. Total public supply withdrawals from combined ground-water and surface-water sources increased by more than 123 percent, but the proportion of surface-water use decreased from 36.9 to 23.8 percent of the totals (Pride, 1972, p. 18; Leach, 1982, p. 21). Ground-water use for agriculture decreased from 30 to 9 percent of the yearly totals, whereas irrigation water use increased by about 50 percent during the 10 years (Pride, 1972, p. 40; Leach, 1982, p. 37). Shifts in source dependence by the major water users reflect coastal urbanization, inland expansion of agriculture, and both the proximity and quality of water sources. These water-use trends also imply public supply ground-water withdrawals are more likely to affect the aquifer system than those of agricultural irrigation.

Increases in public supply withdrawals correspond with both population increases and the number of inhabitants receiving water from public utilities. Census figures show Palm Beach County's population increased from 348,933 in 1970 to 576,863 in 1980, or 65.3 percent (University of Florida, 1981a, p. 33). Estimates of the population served by public supplies during this time increased from 260,000 to 505,100 (Pride, 1972, p. 18; Leach, 1982, p. 165), or 94.4 percent. Cities in the urbanized coastal area (fig. 1) had the greatest population increases, whereas those near Lake Okeechobee had minimal growth (University of Florida, 1981a, p. 27-28).

Increasing public supply withdrawals from the surficial aquifer system provide an artificial impetus to the hydrologic system which, in turn, may precipitate changes in flow directions and water quality. Parts of Palm Beach County serviced by public supply utilities were divided into 5 areas containing the 32 major public supplies (fig. 3) to determine where such changes were most likely to have occurred. Water-use data for 1978-82 were tabulated to identify the parts of the county being subjected to increased ground-water withdrawals (Miller and Alvarez, 1984) and the aquifer system zone(s) from which the withdrawals were taken. Supplementing these data with 1983 withdrawal data (table 1), the peak withdrawals during the 6 years occurred in 1980 and were 5 percent greater than those of 1983. The proportion of ground-water withdrawals to the total public supply withdrawals increased from 74.04 percent in 1978 to 78.35 percent in 1983.

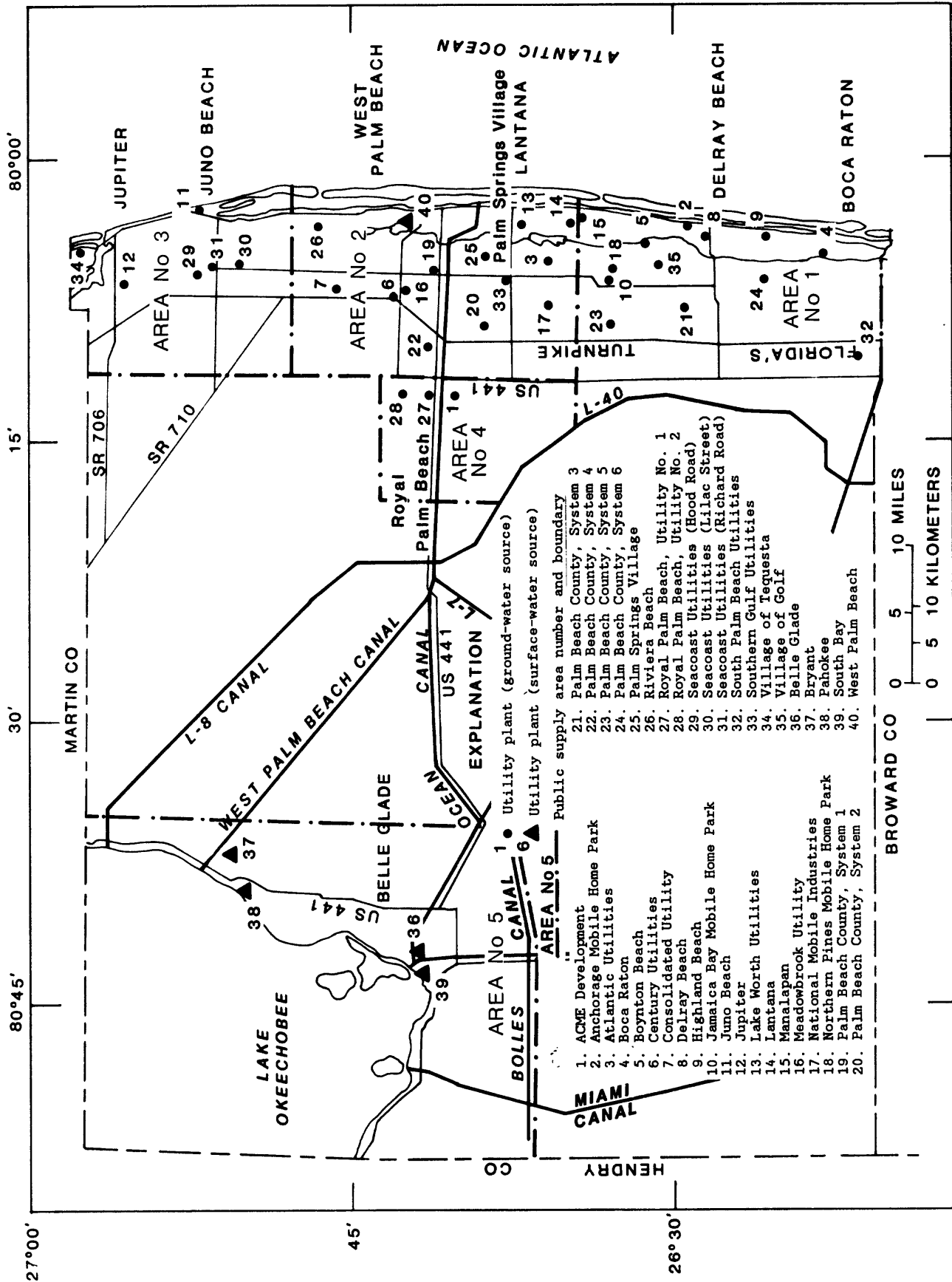

Figure 3.--Location of public supply utilities and public supply areas, Palm Beach County. (Modified from Miller and Alvarez, 1984.)



Table 1.--Total ground-water and surface-water withdrawals by public supply utilities in Palm Beach County, 1978-83 (modified from Miller and Alvarez, 1984, p. 14)

[Withdrawals shown in million gallons; percent of countywide yearly total ground-water or surface-water withdrawal.]

Type of withdrawal	Year	Area No. 1		Area No. 2		Area No. 3	
		Withdrawal	Percent of total	Withdrawal	Percent of total	Withdrawal	Percent of total
Ground water	1978	15,188.88	54.6	7,762.17	27.9	4,497.79	16.2
Surface water		0	0	7,595.90	77.8	0	0
Ground water	1979	17,549.78	54.4	8,904.94	27.6	5,300.76	16.5
Surface water		0	0	7,975.07	78.2	0	0
Ground water	1980	19,028.58	55.3	9,006.06	26.2	5,788.91	16.8
Surface water		0	0	8,520.44	79.0	0	0
Ground water	1981	18,580.44	54.5	9,355.93	27.5	5,402.52	15.9
Surface water		0	0	8,079.29	78.6	0	0
Ground water	1982	19,044.74	56.9	8,876.20	26.4	4,984.51	14.8
Surface water		0	0	7,703.62	79.3	0	0
Ground water	1983	18,340.64	54.9	9,004.51	26.7	5,593.46	16.6
Surface water		0	0	7,318.85	78.6	0	0

Type of withdrawal	Year	Area No. 4		Area No. 5		Subtotal yearly total	Total yearly withdrawal	Percent of yearly withdrawal
		Withdrawal	Percent of total	Withdrawal	Percent of total			
Ground water	1978	374.38	1.3	0	0	27,823.22	37,580.64	74.04
Surface water		0	0	2,161.52	22.2	9,757.42		25.96
Ground water	1979	489.13	1.5	0	0	32,244.61	42,445.55	75.97
Surface water		0	0	2,225.87	21.8	10,200.94		24.03
Ground water	1980	583.00	1.7	0	0	34,406.55	45,193.80	76.13
Surface water		0	0	2,266.81	21.0	10,787.25		23.87
Ground water	1981	711.09	2.1	0	0	34,049.98	44,325.40	76.82
Surface water		0	0	2,196.13	21.4	10,275.42		23.18
Ground water	1982	683.37	1.9	0	0	33,543.84	43,263.48	77.53
Surface water		0	0	2,016.20	20.7	9,719.64		22.47
Ground water	1983	771.49	2.3	0	0	33,714.51	43,029.22	78.35
Surface water		0	0	1,955.86	21.4	9,314.71		21.65

Public supplies in area Nos. 1, 3, and 4 withdrew all their water from the aquifer system, whereas area No. 2 used Clear Lake and Lake Mangonia (fig. 3) as sources for about half its withdrawals. Area No. 5 depended totally on Lake Okeechobee as a source. Total ground-water withdrawals in the county (table 1) increased by 21.17 percent between 1978 and 1983 with the peak withdrawal occurring in 1980. During the same interval, total surface-water withdrawals, which also peaked in 1980, declined slightly.

For each area, actual variations in ground-water and surface-water withdrawals, as well as variations within each area relative to total county withdrawals from the sources, were determined by averaging the data (table 1) in 2-year increments--1978-79, 1980-81, and 1982-83. This approach was chosen also to observe public supply water use before, during, and after the extremely low rainfall of 1980-81. While large rainfall deficiencies were recorded in much of the county (Waller, 1985, p. 8), the demand for public supply water initially increased because of such activities as lawn watering and then decreased when voluntary and mandatory water-use restrictions were imposed (South Florida Water Management District, 1981). Reductions in public supply water-use withdrawals during 1982-83 from those of 1980-81 suggest that public awareness and more vigorous water-resources management combined to decrease water use.

Ground-water withdrawals during each of the 6 years inventoried were greatest in area No. 1. Examined in 2-year increments, actual withdrawals increased 14.2 percent during the 6 years. Relative to total county ground-water withdrawals, area No. 1 withdrawals increased from 54.5 to 55.9 percent of the total. Public supply is withdrawn from both zones I and II of the surficial aquifer system (fig. 2) in area No. 1.

Area Nos. 2 and 3 had actual increases in ground-water withdrawals of 7.3 and 8.0 percent. Relative withdrawals in area No. 2 decreased from 27.8 to 26.6 percent of the total, whereas those in area No. 3 decreased from 16.4 to 15.7 percent. The decrease in relative public supply withdrawals of ground water in area No. 2 was partly compensated for by a slight increase in surface-water withdrawals. In these two areas, zones I and II of the surficial aquifer system are used by public supply.

Although withdrawing the smallest volume of ground water (excluding area No. 5), area No. 4 withdrawals in 1982-83 increased 63.3 percent from those in 1978-79. Relative to public supply ground-water withdrawals in the rest of the county, there was an increase from 1.4 to 2.1 percent of the total. Nearly all the public supply withdrawals in this area are from zone II.

Area No. 5, totally supplied by surface water, had slightly decreased in both actual and relative amounts of public supply withdrawals.

Although the public supply areas are of unequal size, they represent broad sociogeographic divisions in the county (Miller and Alvarez, 1984, p. 3), and public supply water-use statistics are an indicator of areas likely to experience hydrologic variations because of the withdrawals. From these statistics, changes in flow direction and water quality in the aquifer system as a result of increasing ground-water withdrawals most likely have occurred, or will occur, in area Nos. 1 and 4. Although ground-water withdrawals are

a major factor likely to cause such changes, other factors such as land use, surface-water management, and geology of the aquifer system may moderate or mask the effects.

## EFFECTS ON GROUND-WATER LEVELS AND FLOW DIRECTIONS

### Predevelopment Conditions

Before man's influences on the hydrology of south Florida, ground-water levels and flow directions in the surficial aquifer system in Palm Beach County were totally dependent upon local geology, climatic conditions, and physiographic features (fig. 4). Although predevelopment water levels (ground water and surface water) are not available, descriptions of travel conditions observed by military expeditions during the 1800's provide insight to prevailing water conditions. During the spring of 1843, troops traveling from the vicinity of Boca Raton to Lake Okeechobee by canoe found insufficient dry land for overnight camps (Preble, 1883, p. 358-376). Combining this with records of land subsidence in The Everglades (Clayton, 1943, p. 118), it is estimated that the water level was 19 to 20 feet above sea level. Assuming soil and geologic conditions in the Sandy Flatlands and Coastal Ridge (fig. 4) have not allowed extensive land subsidence, current land-surface elevations indicate that much of these areas was also inundated. The predevelopment water table probably ranged from land surface along the periphery of inundated areas to a few feet below land surface in the areas of highest elevation. Under these conditions, aquifer flow directions were generally to the south and southeast from The Everglades, except where the Coastal Ridge caused a ground-water divide shifting flows to the west. Ground-water flow directions were probably similar to early surface-water drainage directions (Parker and Hoy, 1943, p. 43).

### Canal Development

Drainage and flood-control canals connecting Lake Okeechobee with coastal areas in southeast Florida were constructed in the early 1900's and had an immediate effect on ground-water levels. Gravity flow of surface water and induced ground-water flow to the canals, supplemented by pumping beginning in 1925, lowered ground-water levels in The Everglades (fig. 4) sufficiently to contribute to land subsidence of as much as 6 feet by 1940 (Clayton, 1943, p. 118). Flow-regulation structures at the coastal termini of the primary canals generally held surface-water stages above predevelopment levels, causing a corresponding increase in adjacent ground-water levels and reduction of saltwater intrusion in the aquifer system. A description of the primary canals and their water sources is available in Parker and others (1955, p. 348-441).

Subsequent construction of secondary drainage networks of canals and ditches, primarily for flood control, with many pumping and nonpumping water-control structures has allowed the canal network to be used increasingly to regulate ground-water levels. This subsidiary canal use has become as important as flood control in water-management practices. During seasonal excesses of rainfall, the canal network channels water to storage areas, such

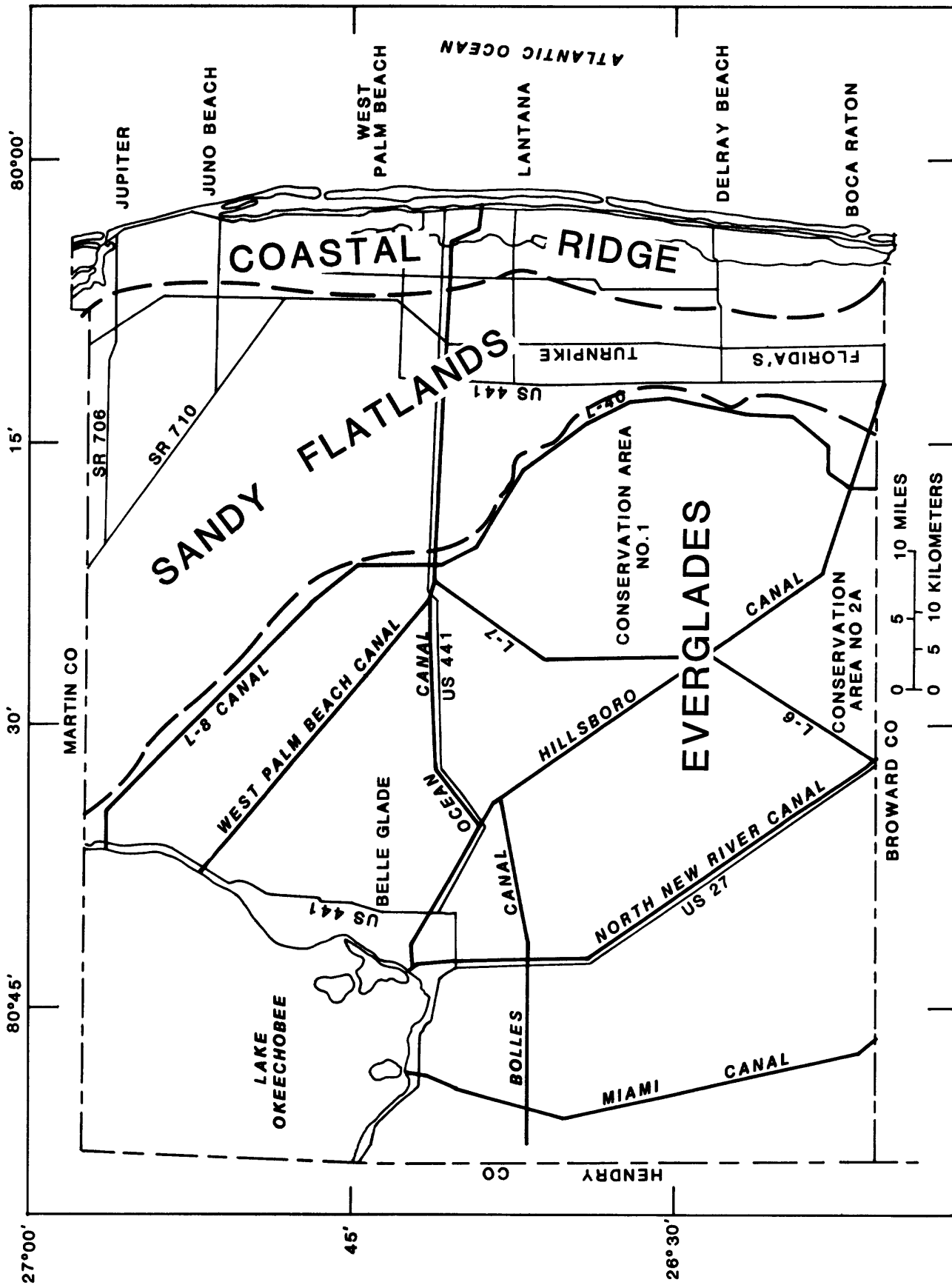

Figure 4.--Physiographic features of Palm Beach County.  
(Modified from Schroeder and others, 1954.)

as Lake Okeechobee and the conservation areas (fig. 4), and to the sea to reduce flooding. During rainfall shortages, the water is conveyed through the canal network from storage areas to coastal areas for well-field recharge and prevention of saltwater intrusion. Along the conveyance route through agricultural areas, the primary canals provide water for crop irrigation.

Ground-Water Levels and Fluctuations Since 1970

Altitude of the water-table maps (henceforth "water-table maps"), prepared for Palm Beach County between 1970 and 1981 (Land and others, 1973, p. 24-25; Rodis and Land, 1976, p. 8; Schneider, 1977; and Swayze and Miller, 1984, p. 19), indicate only minimal changes in ground-water levels during 10 years in which extensive urban and agricultural expansion have at least doubled water use. These water-table maps represent ground-water levels measured during a limited timespan near the end of the dry season (November to April) or the wet season (May to October). Variations that occur during the rest of the year are seldom recorded because most of the data sites are measured periodically. Even though the number and locations of data sites measured to prepare these maps are known to have varied and the map scales mask areally small water-table variations, the maps cumulatively indicate the effectiveness of water management in offsetting the impacts of climatic and cultural variations on ground-water levels.

Water-table maps for April and November 1984 (figs. 5 and 6) show that, in some areas, ground-water levels were higher during the dry season than the wet season. Extensive surface-water management for flood control and agriculture masks seasonal climatic effects on ground-water levels in most of the county. To better understand and quantify the magnitude of countywide variations, ground-water levels in a 110-well network were measured 4 times between October 1983 and May 1985. The fluctuation of the water table during this period, which represents two dry-wet season cycles, was determined at each well by subtracting the least from the greatest water-level measurement. From these values, the following statistics for ground-water fluctuations were determined:

	Total county	Agricultural area	Urbanized area
[Values shown in feet]			
Number of wells	110	39	71
Maximum	6.35	5.29	6.35
Minimum	.10	.11	.10
Median	1.41	1.41	1.44
Average	1.60	1.53	1.64

Although land uses overlap to some extent, the boundary between The Everglades and the Sandy Flatlands (fig. 4) was chosen to differentiate the parts of the county where the aquifer system is influenced by agriculture and



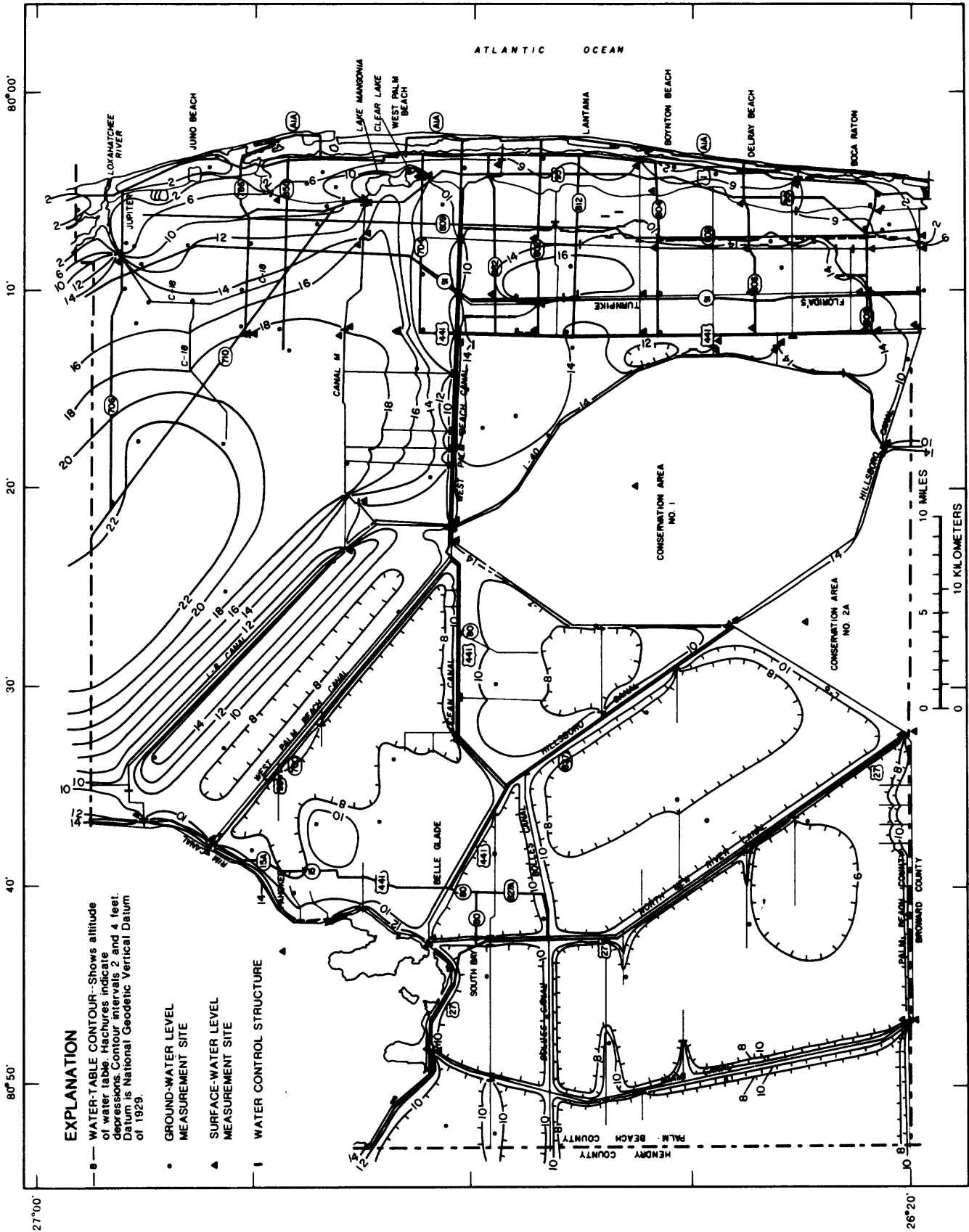

- EXPLANATION**
- WATER-TABLE CONTOUR—Shows altitude of water table. Tick marks indicate depressions. Contours are at 2 and 4 feet. Datum is National Geodetic Vertical Datum of 1929.
  - GROUND-WATER LEVEL MEASUREMENT SITE
  - ▲ SURFACE-WATER LEVEL MEASUREMENT SITE
  - WATER CONTROL STRUCTURE

Figure 6.--Altitude of water table, surficial aquifer system, Palm Beach County, November 1984. (Modified from Miller, 1985b.)

by urbanization. Statistics for these two areas represent the effects on ground-water levels of agricultural water-management practices, such as irrigation and dewatering in The Everglades to the west and flood control and public supply withdrawals in urbanized land east of the boundary.

The similarity of the statistics, whether categorized as urban area, agricultural area, or for the total county, indicates that irrespective of land and water use, the water-table fluctuation is generally less than 2 feet. Median fluctuations consistently less than average values indicate that larger ground-water level fluctuations, such as those at or near maximum values, are the exceptions. Wells in which near maximum fluctuations were recorded in the urban area are in the immediate vicinity of well fields, whereas those in the agricultural area were near flood irrigation operations. Overall, the current land uses combined with regulated primary and secondary canal stages have prevented large fluctuations in ground-water levels in all but localized parts of the county.

#### Ground-Water Flow Directions

Increasing ground-water withdrawals from new and existing public supply and domestic wells, along with manipulation of canal stages for various water-management purposes, have singularly or cumulatively caused changes of ground-water flow directions in parts of the surficial aquifer system in Palm Beach County. Changes in flow direction occur when water withdrawals from the aquifer system by wells or discharge to canals are sufficient to increase hydraulic gradients (slope of water table) toward the point(s) of discharge. Features such as canals or water impoundments with stages above the water table contribute recharge to the aquifer system that produces a hydraulic gradient away from the recharging feature. In both situations, the steepness of hydraulic gradients is heavily dependent upon the aquifer system's permeability, increasing as permeability decreases.

Changes of ground-water flow directions in the aquifer system were evaluated using flow directions indicated by the previously discussed water-table maps for October 1970 to March 1981 as a base for comparison with those of April and November 1984 (fig. 7). Assuming that ground-water flows are perpendicular to water-table contours on the maps (Todd, 1967, p. 66): (1) water-table maps were adjusted to a common scale; (2) maps were overlain by a grid consisting of 5 minutes of degree longitude and latitude quadrants, and the ground-water flow direction at the center point of each quadrant for which data were available was graphically resolved; (3) identification numbers (1 to 55) were assigned to quadrants in which flow directions were determined; and (4) average flow direction in each quadrant between October 1970 and March 1981 and between April and November 1984 was determined. (Water-table maps for October 1970, April 1971, and March 1981 covered only the eastern third of the county.)

Yearly precipitation in Palm Beach County was near normal during 1984, and no precipitation was recorded during the 7 days preceding the ground-water level measurements made in April and November (National Hurricane Center Weather Service, oral commun., 1985). Precipitation records for the times immediately preceding ground-water level measurements used to prepare the 1970-81 water-table maps were not available.





In the predominantly agricultural area of the county, average ground-water flow directions for the base period and 1984 were determined in quadrants 1 to 26, 28 to 32, and 35 (fig. 7). Zone III of the aquifer system, underlying the area, is typified by low permeabilities, as reflected by steep hydraulic gradients adjacent to canals (figs. 5 and 6). The area has a maze of interconnected drainage ditches and canals, usually dredged to below the water table, to control flooding of croplands and provide irrigation water. Primary canals conveying water to and from Lake Okeechobee are the receptacles of excess water pumped from the ditches and are the source of irrigation water released to the ditches. Pumping for drainage frequently draws stages in the ditches below the water table, and large areas of the aquifer system are partially dewatered. Although stages in the primary canals are normally above land surface, low permeabilities in levee aquifer materials prevent rapid infiltration from the canals and retard recharge of dewatered areas. Low permeabilities also cause ponding of water applied for irrigation or flooding of fallow fields for extended lengths of time.

Because of the near absence of wells used for public, domestic, or irrigation water supplies in the agricultural area, flow directions in zone III of the aquifer system were largely controlled by head differentials between canals and water impoundments or dewatered areas. Little or no change in flow directions was detected in most of the area. Inspection of quadrants 5, 7, 11, 14, 16, 23, 26, 31, and 32, which had apparent changes in average flow directions between the base period and 1984, showed that most of the changes were false indications caused by new data sites. The increased number of data sites in this part of the county allowed more complete definition of the water table during 1984 than was possible with data available during the base period. In quadrant 30, several large fields in fallow had been flooded for weed and insect control throughout most of 1984. The flooded fields in the northern half of the quadrant caused the apparent change in ground-water flow direction.

In the urbanized part of the county, underlain by zones I and II, of the aquifer system, differences in 1984 ground-water flow directions from the base period, which were partly attributed to increased public supply well-field withdrawals, occurred in quadrants 42 and 47 to 53 (fig. 7). Flow direction changes in quadrants 47 and 48 indicate the increasing influence of withdrawals at the Jupiter and Seacoast Utilities (Lilac Street) well fields (fig. 3). The shift in quadrant 49 reflects increasing withdrawals from the Century Utilities well field and possibly the Palm Beach County System 1 (west) well field. In quadrant 42, the change in ground-water flow direction is toward the Royal Palm Beach Utility No. 1 well field.

Although ground-water flow directions in the Lake Worth Drainage District (fig. 1) are generally dictated by extensive regulation of stages in canals, the effects of well-field withdrawals were detected in several areas. Well fields between Palm Springs Village and Boca Raton (fig. 3) have caused flow directions at the center points of quadrants 50 to 53 to be more directly oriented toward the well fields. Public supply area Nos. 1 and 4, previously indicated as having a high potential for changes in ground-water flow directions, had such changes as did area Nos. 2 and 3. Increases in well-field withdrawals are one of the variables influencing ground-water flow directions. The extent to which flow direction variations were attributable to changes in well-field withdrawals could not be determined with the data available.

The reversal of ground-water flow directions in quadrant 41 was caused by withdrawals from domestic wells in a small development immediately west of the quadrant centerpoint. Low permeabilities and semipermeable marl layers in the aquifer system in this area magnified the effects of limited ground-water withdrawals on the water table and resultant flow directions.

Flow direction changes in the urbanized area not discussed were assumed to be primarily the results of varying stages in nearby canals. It is presently not known if ground-water withdrawals have contributed to the changes.

No long-term changes in ground-water flow directions as a result of water-use variations, either ground water or surface water, were discernible in the agricultural area during the years surveyed. During the same years, 9 of 23 quadrants in the urbanized area had changes in ground-water flow directions partly or totally attributable to increased ground-water withdrawals.

#### GROUND-WATER QUALITY

In addition to localized degradation by manmade contaminants and salt-water intrusion from the sea (Swayze and Miller, 1984, p. 30-34), water quality in the surficial aquifer system in Palm Beach County is affected by highly mineralized ground water in the central and western parts of the county. This poor quality water, which contains high dissolved solids and chloride concentrations, was observed as early as the 1930's (Stringfield, 1933, p. 25) and was subsequently attributed to interglacial seas that inundated the area during the Pleistocene Epoch (Parker and others, 1944, p. 16). Low permeabilities in this part of the surficial aquifer system (generally zone III, fig. 2) have greatly retarded dilution of the residual seawater by infiltrating rainfall and fresh surface water. Greater permeabilities in the rest of the surficial aquifer system (zones I and II) have generally allowed near total removal of the residual seawater, although high chloride concentrations in scattered wells suggest the process is incomplete.

In the central and western parts of the county, residual seawater in the surficial aquifer system has had limited impact on water users because of the availability of fresh surface water from Lake Okeechobee and the conservation areas (fig. 1). Planners for the eastern part of the county, which relies heavily on ground water for public and private supplies, are concerned that increasing ground-water withdrawals coupled with westward expansion of urbanization may be causing the residual seawater to migrate eastward toward developed areas. Eastward migration of poor quality ground water could occur if withdrawals along the coast shift ground-water divides (figs. 5 and 6) to the west and induce residual seawater to move east. Also, if the residual seawater enters canals used to convey water from Lake Okeechobee and the conservation areas to coastal areas, the increased mineralization of the canal water could alter ground-water quality in those parts of the aquifer system recharged by canals.

To delineate the area in Palm Beach County in which the surficial aquifer system contains highly mineralized water and determine if eastward migration has occurred, countywide ground-water and surface-water sampling networks were

established. The ground-water network (fig. 8 and table 2) consisted of 94 wells, ranging in depth from 9 to 220 feet; the surface-water network (fig. 8 and table 3) included 25 sites on perennial drainage features. A total of 33 wells were drilled and 1 surface-water site was established where existing sampling sites were absent or inadequate. Both networks contained representative sites within the three zones of the surficial aquifer system.

Water samples were collected toward the end of the dry seasons and wet seasons during 1983-84. Ground-water samples from 57 wells were analyzed for concentrations of major inorganic constituents and related chemical characteristics (table 4 at end of report). An additional 37 wells were analyzed only for chloride concentrations (table 5 at end of report). Surface-water samples were analyzed for major inorganic constituents and dissolved solids (table 6 at end of report). Analyses were performed at the U.S. Geological Survey Water Quality Service Unit Laboratory in Ocala, Fla. Samples collected for chloride concentration determinations were analyzed at the U.S. Geological Survey office in Miami, Fla. Water-quality data for the sites listed in tables 2 and 3 are available from WATSTORE, the U.S. Geological Survey's Water Data and Retrieval System.

#### Effects on Area of Highly Mineralized Ground Water

More than 40 years have passed since investigators first prepared maps of south Florida showing ranges of chloride concentrations in wells of various depths to illustrate degrees of ground-water mineralization (Parker and others, 1944, plate 4). The use of chloride concentrations to represent ground-water mineralization on the maps, along with a discussion of the area's water chemistry, was later explained in detail by Parker and others (1955, p. 218-222). These maps did not include areas of ground-water mineralization associated with recent saltwater intrusion.

The Palm Beach County parts of the maps (fig. 9), prepared with 1941-43 data, were compared with similar maps prepared with chloride concentration data collected from September 1983 to April 1984 (figs. 10-12) to delineate the current areal extent of the highly mineralized ground water. The 1983-84 countywide maps, also used to evaluate migration of the water, were prepared for similar depth intervals and chloride concentration ranges as the earlier maps. Because none of the approximately 45 wells sampled for the earlier map still exist, 56 more recently drilled wells were sampled for chloride in 1983-84 (tables 4 and 5 at end of report). Depth intervals of the sampled wells were: as much as 20 feet deep, 20 to 50 feet deep, and 51 to 100 feet deep. Chloride data (table 7 at end of report) from samples collected at various depths during drilling of 27 new wells in September and October 1983 and wells PB-1428, G-2313, G-2314, and G-2315 sampled during drilling in 1981 (figs. 10-12) were also used in preparation of these maps. Lack of data for the 1941-43 sampling and low permeabilities in zone III, discussed previously, precluded consideration or comparison of the effects of antecedent rainfall on chloride concentrations during the two mapping periods.

Boundaries between chloride ranges in figures 10 to 12 are approximate. Exceptions at individual wells within an area are bounded by dashed lines, indicating the unknown extent of water containing the variant chloride concentration. It is presumed that a greater density of sampling sites would yield other areas of exception due to the observed variability of ground-water mineralization in the western two-thirds of the county.



Table 2.--Map, local, and identification numbers of wells sampled for water quality, the surficial aquifer system zone in which they are located, and their depth

[Locations shown in figure 8]

Zone I				Zone II			
Map number	Local well number	Identification number	Depth (feet)	Map number	Local well number	Identification number	Depth (feet)
1	PB-88	263652080033801	17	2	PB-99	264005080233501	17
3	PB-445	263328080085201	11	7	PB-566	265604080094401	10
6	PB-563	265027080115601	9	8	PB-618	264659080035101	32
11	PB-671	263523080085201	119	13	PB-684	264041080171201	18
12	PB-683	263524080124301	17	14	PB-685	264208080192201	17
23	PB-719	265018080074101	24	15	PB-687	265525080113001	17
24	PB-738	263137080121601	24	16	PB-689	265633080203001	17
25	PB-750	263816080161101	84	17	PB-711A	265510080083401	50
26	PB-751	263816080161102	25	18	PB-711B	265510080083402	29
38	PB-845	264653080063701	86	19	PB-715	265114080173101	67
45	PB-936	263606080115101	10	20	PB-716	265114080173102	15
47	PB-1084	265027080100201	133	21	PB-717	265519080171801	20
48	PB-1085	265027080115702	87	22	PB-718	265258080074301	21
49	PB-1089	264225080084701	143	27	PB-752	262018080063801	32
50	PB-1094	263629080171401	97	28	PB-789	265550080071801	110
51	PB-1096	263138080095201	88	29	PB-799	264619080054601	152
52	PB-1097	263144080134001	86	30	PB-800	264612080044601	38
54	PB-1099	265250080103601	88	31	PB-830	265106080241401	126
55	PB-1100A	262007080134501	95	32	PB-831	265106080241402	20
56	PB-1100B	262007080134502	58	33	PB-832	265611080081201	141
57	PB-1101	262405080071801	93	39	PB-875	265439080102904	22
58	PB-1104	262645080071801	105	40	PB-876	265439080102903	41
59	PB-1105	261938080101001	127	41	PB-877	265439080102902	98
60	PB-1107	262808080131701	101	42	PB-880	265439080102901	117
61	PB-1108	262403080141301	88	44	PB-921	265153080031401	150
66	PB-1155	263755080102605	120	46	PB-1063	261950080074301	134
67	PB-1156	263752080120701	115	53	PB-1098	265835080130201	75
				62	PB-1109A	265115080173101	126
				63	PB-1154	Well destroyed	50
				64	PB-1152	263942080164002	112
				65	PB-1153	264027080135004	44
				68	PB-1157	264216080134403	100
				69	PB-1460	264553080182701	30
				70	PB-1461	264019080215201	45

Zone III			
Map number	Local well number	Identification number	Depth (feet)
4	PB-560	265240080372103	27
5	PB-529	265240080372102	10
9	PB-662A	264808080403201	25
10	PB-662B	264808080403202	19
34	PB-836	264048080322307	90
35	PB-838	265134080373801	88
36	PB-840	262713080375001	84
37	PB-843	264152080483401	93
43	PB-899	264007080382001	62
71	PB-1462	264625080233501	40
72	PB-1463	263857080293501	43
73	PB-1464	264330080331701	45
74	PB-1465	264700080364501	45
75	PB-1466	265122080325501	43
76	PB-1467	265450080335001	40
77	PB-1468	263224080302501	45
78	PB-1469	263040080360301	45
79	PB-1470	262907080360201	45
80	PB-1471	263857080382001	45
81	PB-1472	263637080412001	45
82	PB-1473	262355080360201	45
83	PB-1474	263107080405201	45
84	PB-1475	263303080441701	65
85	PB-1476	263635080462301	45
86	PB-1477	263907080521301	45
87	PB-1478	264120080520001	25
88	PB-1479	264357080363801	45
89	PB-1480	263355080485001	25
90	PB-1481	264325080262701	215
91	PB-1482	264845080340001	145
92	PB-1483	263410080265301	212
93	PB-1484	263910080442501	190
94	PB-1485	262722080424501	220
95	PB-1486	262837080491701	220

Table 3.--Map, local, and identification numbers of surface-water sites sampled for water quality and the surficial aquifer system zone in which they are located

[Locations shown in figure 8; site 009 was not sampled.]

Map number	Local site number	Identification number
<u>Zone II</u>		
005	PB-005	02281544
006	PB-006	02281532
007	PB-007	02281425
015	PB-015	02281419
016	PB-016	02281297
017	PB-017	264047080120800
019	PB-019	02281513
<u>Zone II</u>		
003	PB-003	02278760
004	PB-004	02281625
008	PB-008	02281301
011	PB-011	02278698
012	PB-012	02277750
013	PB-013	02278450
014	PB-014	02278600
018	PB-018	02277700
<u>Zone III</u>		
001	PB-001	02284000
002	PB-002	02284300
010	PB-010	02281200
020	PB-020	02278002
021	PB-021	265501080364900
022	PB-022	02286400
023	PB-023	02283498
024	PB-024	02280500
025	PB-025	263640080502000
026	PB-026	262837080491700

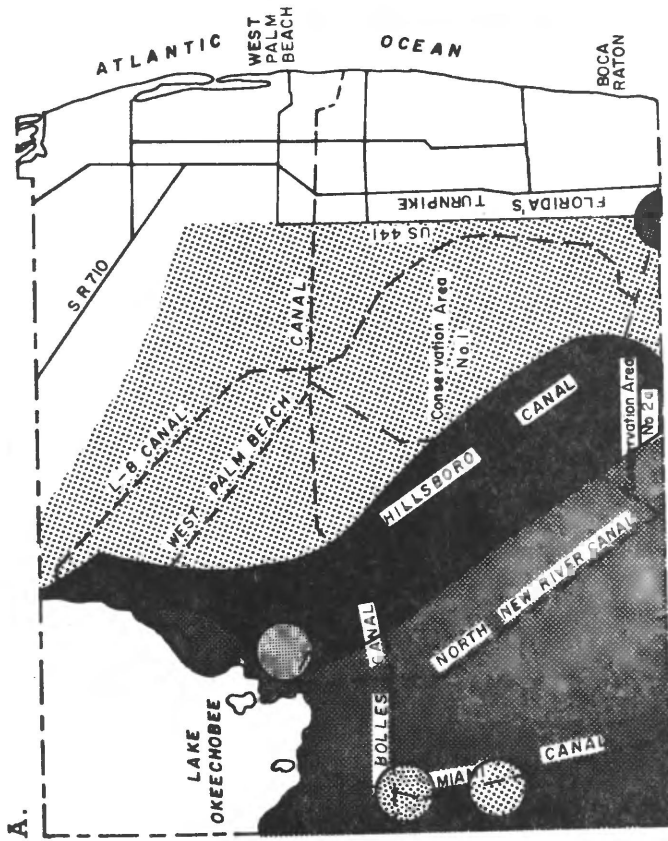
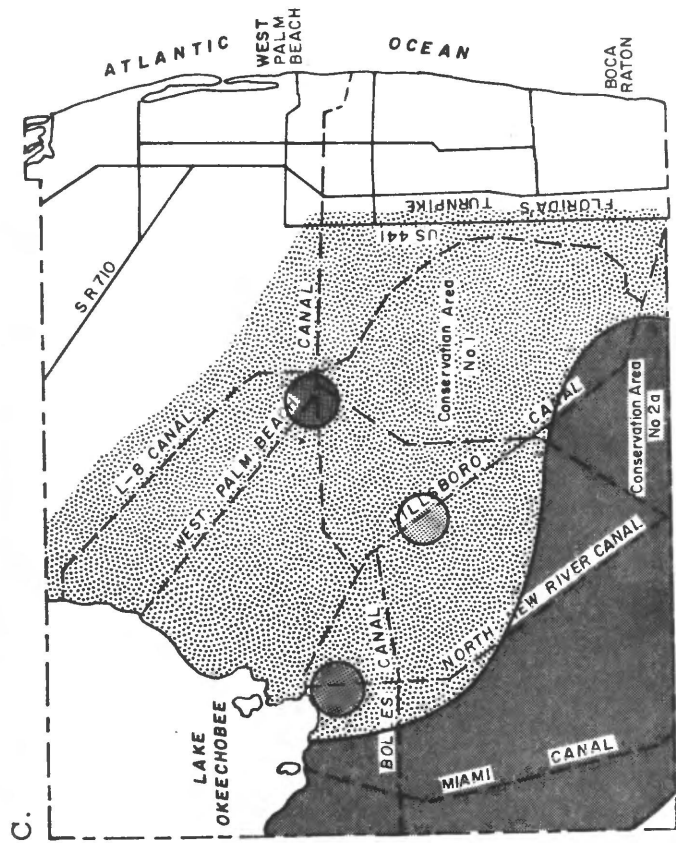
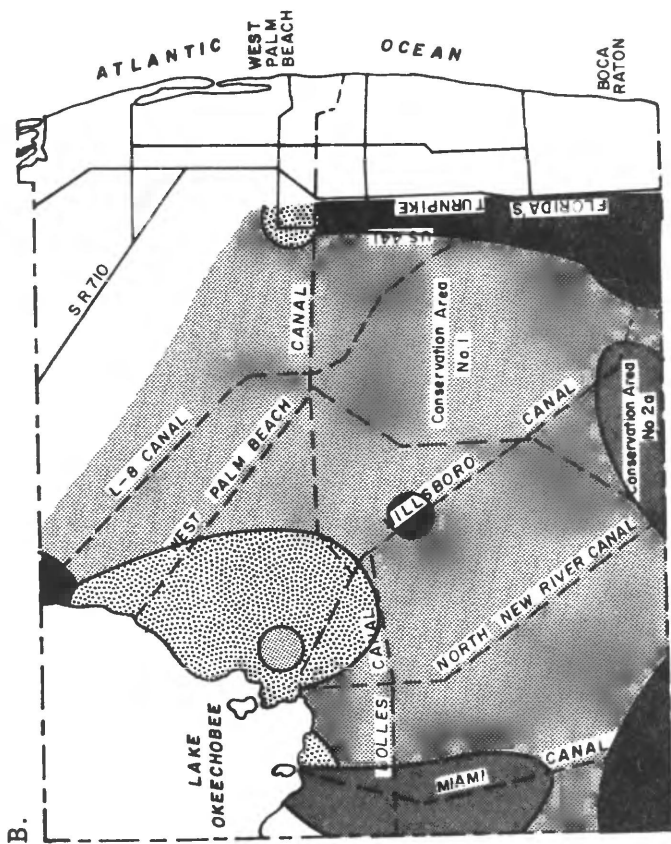

EXPLANATION  
CHLORIDE CONCENTRATIONS,  
MILLIGRAMS PER LITER

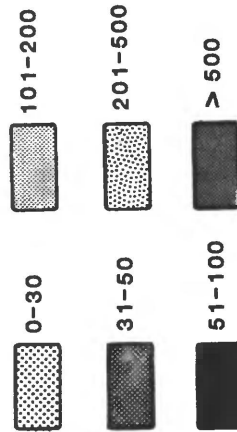

Figure 9.--Chloride concentrations of water in (a) wells as much as 20 feet deep, (b) wells 20 to 50 feet deep, and (c) wells 51 to 100 feet deep in the surficial aquifer system, Palm Beach County, 1941-43. (Modified from Parker and others, 1944, p. 15.)





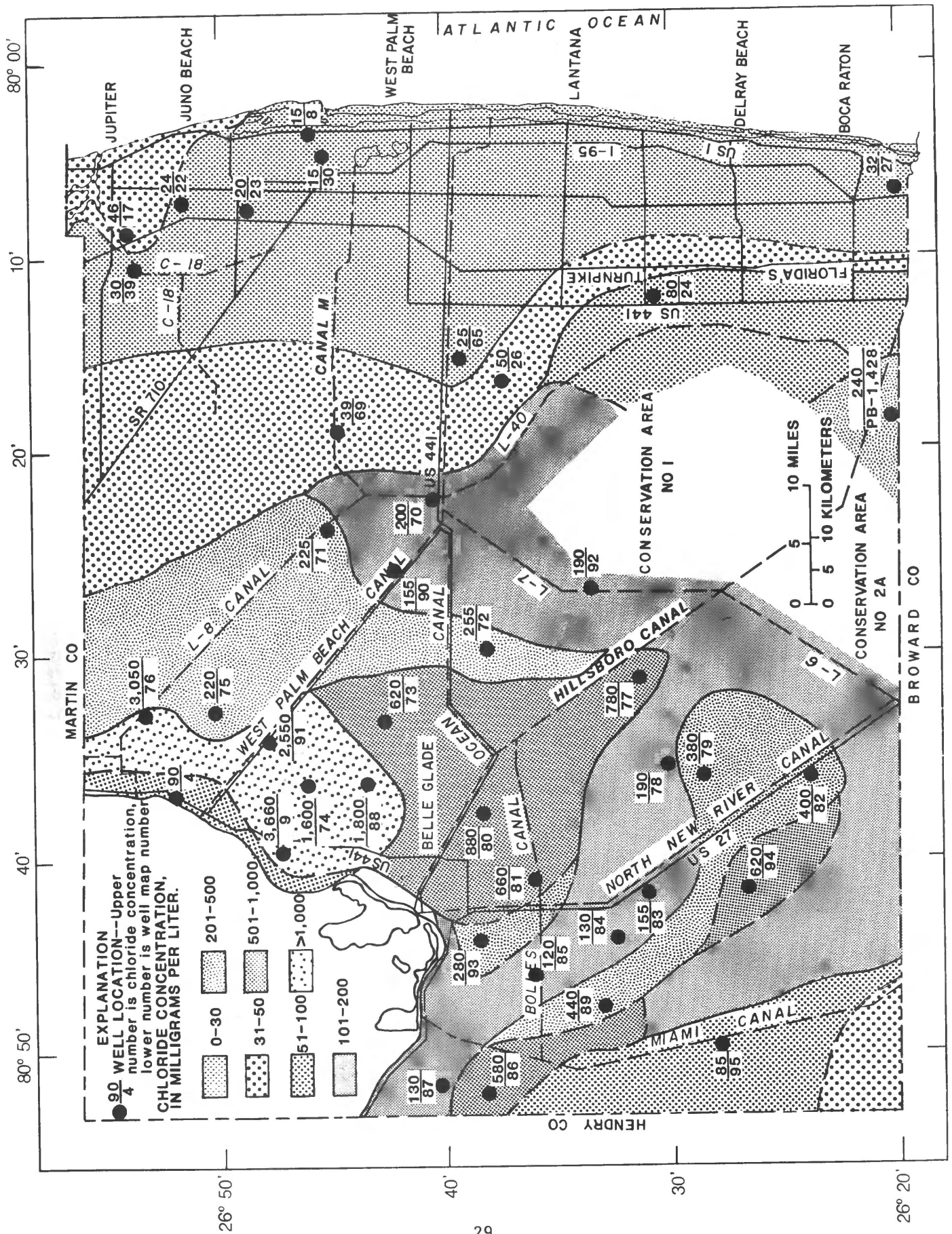

Figure 11.--Chloride concentrations of water at depths of 20 to 50 feet in the surficial aquifer system, Palm Beach County, 1983-84.



Comparison of chloride concentrations in the as much as 20-foot depth interval in 1941-43 (fig. 9) with those in 1983-84 (fig. 10) shows a general increase in concentrations throughout the western and central parts of the county. The earlier map indicates that, with isolated exceptions, the ground water in this depth interval had chloride concentrations of less than 100 mg/L (milligrams per liter). By 1983-84, a large part of the surficial aquifer system on the southeastern perimeter of Lake Okeechobee contained water with chloride concentrations ranging from 201 to 500 mg/L (fig. 10). Also, the area in which ground water contained chloride concentrations ranging from 101 to 200 mg/L or greater had expanded east of the levee L-8 Canal and Conservation Area No. 1 in much of the county.

In the 20- to 50-foot depth interval, the 1943 map (fig. 9) showed chloride concentrations greater than 500 mg/L in areas along the western and southern county lines. An area near Lake Okeechobee, between the West Palm Beach and Hillsboro Canals, had ground water with chloride concentrations ranging from 201 to 500 mg/L. In 1983 (fig. 11), ground water in this depth interval had chloride concentrations greater than 500 mg/L in an area just east of Lake Okeechobee from the north county line to near the North New River Canal. In much of this area, the ground water had chloride concentrations greater than 1,000 mg/L (not differentiated in fig. 9). No wells near the south county line were found to have chloride concentrations greater than 500 mg/L in this depth interval.

In the 51- to 100-foot depth interval, the 1941-43 (fig. 9) map showed a large area, extending south from Lake Okeechobee along the Miami Canal and extending east of the Hillsboro Canal along the south county line, which had ground water with chloride concentrations greater than 500 mg/L. The rest of the area surveyed in 1941-43 generally had chloride concentrations ranging from 201 to 500 mg/L. The 1983-84 map (fig. 12) for this interval indicates that nearly all the area west of Conservation Area No. 1 had ground water with chloride concentrations greater than 500 mg/L--chloride concentrations were greater than 1,000 mg/L in much of this area--and ground water with chloride concentrations greater than 500 mg/L extended east of the levee L-8 Canal in the northern part of the county.

The 1941-43 maps (fig. 9) did not extend east of U.S. Highway 441, thus, preventing comparison of this area with chloride concentrations shown on the 1983-84 maps (figs. 10-12). The more permeable zones I and II (fig. 2) of the surficial aquifer system underlie this part of Palm Beach County, and chloride concentrations in 1983-84 generally were less than 100 mg/L, except in coastal areas experiencing recent saltwater intrusion. Somewhat higher chloride concentrations (as much as 200 mg/L) in the surficial aquifer system immediately east of Conservation Area No. 1 reflect a less well-developed zone of secondary porosity in this area (Swayze and Miller, 1984, figs. 2.1.1-4, 5, and 6). Isolated pockets of residual seawater, such as along Canal C-18 (fig. 12), may exist elsewhere in these zones.

Areas in the western and central parts of the county in which ground water has chloride concentrations ranging from 201 to 500 mg/L or greater have expanded in all three depth intervals during the 40 years, primarily because of upward migration of residual seawater. Low areal ground-water

gradients (generally 0.25-0.75 ft/mi) toward the interior of the area indicate that horizontal migration of the residual seawater has been minimal and not significantly contributing to the expansion. Some chloride concentration increases in the uppermost depth interval may also be associated with applications of agricultural chemicals, oxidation of organic soils, and evapotranspiration. Upward migration or upwelling of saline or otherwise mineralized ground water is frequently associated with well pumpage in intruded areas, but is not a factor in this area because few wells exist and pumpage is minimal.

In the predominantly agricultural area overlying zone III of the surficial aquifer system (fig. 2), agricultural drainage including partial dewatering (hereafter "dewatering") of the upper part of the aquifer system is used to reduce flooding of low-lying fields. Stages in many drainage ditches and canals are reduced to below water table by pumpage, causing ground-water discharge to the canals. Water pumped from drainage canals to primary canals tends to flow from the area rather than infiltrate because of low permeabilities in canal bottom sediments and surficial aquifer system materials.

Prior to agricultural development in the area, zone III of the surficial aquifer system contained nearly stagnant water because of the basin structure which greatly retarded ground-water flows. Seawater emplaced during Pleistocene invasions by the sea, and brackish water and freshwater emplaced when the area was covered by lakes and swamps, were at or near hydrostatic conditions. Under these conditions, more recently infiltrated freshwater in the upper part of the aquifer system was separated from the residual seawater by a relatively thin transition zone containing a mixture of the two waters. This situation is analogous to freshwater lenses on oceanic islands where density differences retard mixing of infiltrating freshwater and underlying saltwater.

Initial drainage of the area and repeated dewatering episodes during the 40 years between chloride concentration mapping efforts have removed more freshwater from the upper part of the aquifer system than could be replaced by infiltration through low permeability organic soils and near-surface marls. Lowered freshwater heads have created hydrodynamic conditions in zone III of the surficial aquifer system, allowing the transition zone containing partly diluted residual seawater to thicken and the water with higher chloride concentrations to migrate upward. The net effect is an increase in chloride concentrations in the surveyed depth intervals. Data are insufficient to determine if chloride concentration increases in the upper 100 feet of the aquifer system represent upward migration of residual seawater only in the expanded transition zone, or if the upward migration extends from the base of the surficial aquifer system. Limited data available, historical and recent, for deeper parts of the surficial aquifer system generally show chloride concentrations increasing with depth.

Large increases in chloride concentrations in the three depth intervals have occurred in the area extending southeast from Lake Okeechobee and roughly bracketed by the Miami and levee L-8 Canals, as indicated by comparison of figure 9 with figures 10 to 12. Zone III of the surficial aquifer system thins toward the lake in this part of the county (Miller, 1986), and materials in which Pleistocene seawater was emplaced are nearer present land surface than elsewhere. Extensive drainage of the area, beginning in the early 1900's, permanently lowered the water table, causing land subsidence of as

much as 6 feet because of oxidation of the organic soils. This area was among the first in the county to be extensively farmed. Also, very low permeabilities in organic soils and marls blanketing the area have retarded dilution of residual seawater and development of the freshwater layer. Combined effects of these factors have produced the increasingly large area in which chloride concentrations in the upper 100 feet of the surficial aquifer system have degraded water quality.

Continued upward migration of highly mineralized water is likely in those parts of the area in which ground water in the 51- to 100-foot depth interval currently has chloride concentrations greater than 100 mg/L (fig. 12). This area extending an unknown distance under Conservation Area Nos. 1 and 2A generally delineates the eastern boundary of residual seawater in the surficial aquifer system in Palm Beach County. Other than isolated exceptions previously mentioned, samples collected from wells partially or fully penetrating the surficial aquifer system east of this area (table 4 at end of report) contained little or no residual seawater. Because of limited data, the western and southern boundaries of the area that contain residual seawater are speculative.

In the eastern part of the county, generally zones I and II of the surficial aquifer system (fig. 2), much of the land may have remained above sea level during most of the Pleistocene invasions by the sea to which the residual seawater is attributed. Permeabilities in zones I and II are sufficiently high to have permitted near total removal of residual seawater from most of the area that was inundated or otherwise intruded by the Pleistocene seas.

Ground-water divides, extending north to south through the Lake Worth Drainage District and northwest to southeast between State Road 710 (SR-710) and the levee L-8 Canal (fig. 5), have prevented further eastward migration of the highly mineralized water within the surficial aquifer system. The rapidly increasing public supply ground-water withdrawals (table 1), combined with private well withdrawals in eastern Palm Beach County, have not lowered the water table sufficiently to shift the ground-water divides west into the area of highly mineralized ground water. As urban expansion with accompanying public and private ground-water withdrawals moves farther inland from the coast, the possibility that the ground-water divides will shift west (allowing poor quality water to flow eastward in the surficial aquifer system) will increase.

#### Effects of Ground-Water/Surface-Water Exchange on Water Quality in the Surficial Aquifer System

The exchange of ground water and surface water in the surficial aquifer system and canals in Palm Beach County provides another method by which the poorer quality ground water in the western part of the county could move toward coastal areas. The Levee L-8, West Palm Beach, and Hillsboro Canals are used to convey water from Lake Okeechobee and the conservation areas (fig. 8) to coastal areas in the county during rainfall shortages. The North New River and Miami Canals convey water from Lake Okeechobee to coastal areas south of Palm Beach County. The major purposes of the primary canals are to provide water for ground-water recharge and to maintain canal stages along the coast to prevent saltwater intrusion. The Lake Worth Drainage District draws water from Conservation Area No. 1 for similar purposes.

The canal routes and conservation areas overlie parts of the surficial aquifer system containing highly mineralized ground water (figs. 10-12). During conveyance from the surface-water storage areas, water in the canals may become more mineralized by mixing with the ground water. Low permeabilities, previously discussed, and maintained high stages prevent most direct discharge of highly mineralized ground water into the channels of the primary canals. However, large quantities of highly mineralized water are pumped into the primary canals from secondary canals and ditches during agricultural dewatering operations. For the purposes of this investigation, this is considered an indirect ground-water discharge. If the influx of this ground water increases mineralization of the canal water to above concentrations normally found in the ground water of the more permeable zones I and II (fig. 2) of the aquifer system, water quality in these zones could be degraded by infiltration of the canal water. Ground water discharging into the canals from more permeable zones of the aquifer system will mix with the canal water, diluting and masking the chemical characteristics of the conveyed water.

Chemical analyses of canal (surface) water and ground water from shallow wells (tables 4 and 6 at end of report) near the primary canal routes were examined to determine if these water-management practices had caused mineralized water to move eastward and adversely affect water quality in the more permeable zones of the surficial aquifer system. Analyses of samples collected April 11-27, 1984, were representative of conditions most likely to cause direct and indirect discharges of highly mineralized ground water into primary canals in the western part of the county and its conveyance toward coastal areas. These samples were collected near the end of south Florida's November to April dry season, which is coincident with the area's major agricultural growing season. During sampling, agricultural drainage canals were frequently observed discharging water to primary canals. Also, water was periodically released to primary canals from Lake Okeechobee and Conservation Area No. 1, and only trace amounts of rainfall were recorded in the county. Neither Lake Okeechobee nor Conservation Area No. 1 were sampled; hence, the following discussions relate to only those water-quality changes which occurred between the upstream and downstream sampling sites.

The compositions of canal water and adjacent ground water were evaluated by construction of polygonal diagrams (Stiff, 1951), using three parallel axes extending on each side of a vertical zero axis (fig. 13). Concentrations of major cations and anions, converted to milliequivalents per liter, are plotted on their respective axis. The respective points are connected to form an irregular polygonal shape, which provides a visual representation of the water's composition. Differences or similarities in water can be recognized by comparing the polygonal shapes (Stiff diagrams).

Water can be classified by dominant cation (sodium and potassium, calcium, magnesium) and anion (chloride, bicarbonate, sulfate) groups. In ground water and surface water, samples that contain residual seawater have dominant sodium and chloride ions. Samples not so affected have dominant calcium and bicarbonate ions. Samples that contain residual seawater diluted by waters which have flowed over or through carbonate materials will usually have a mixed composition.

**EXPLANATION**

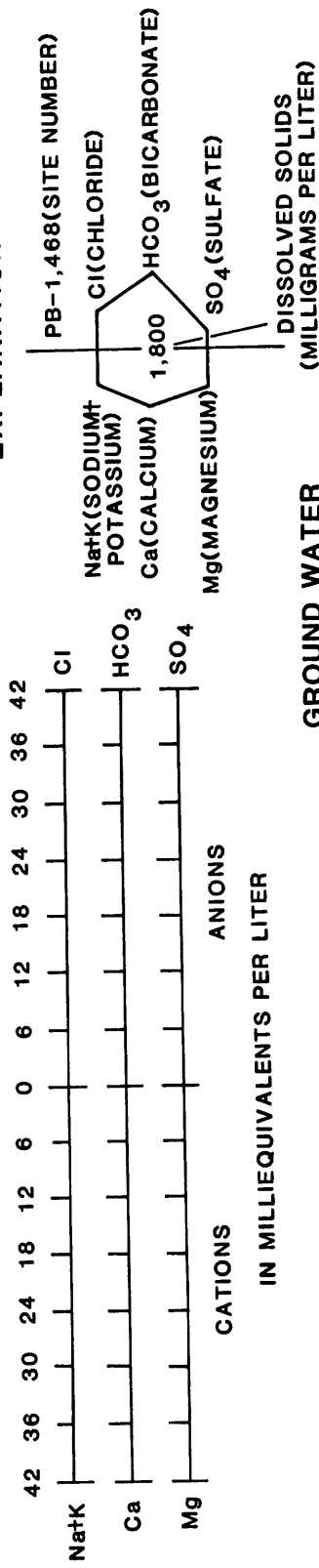

**GROUND WATER**

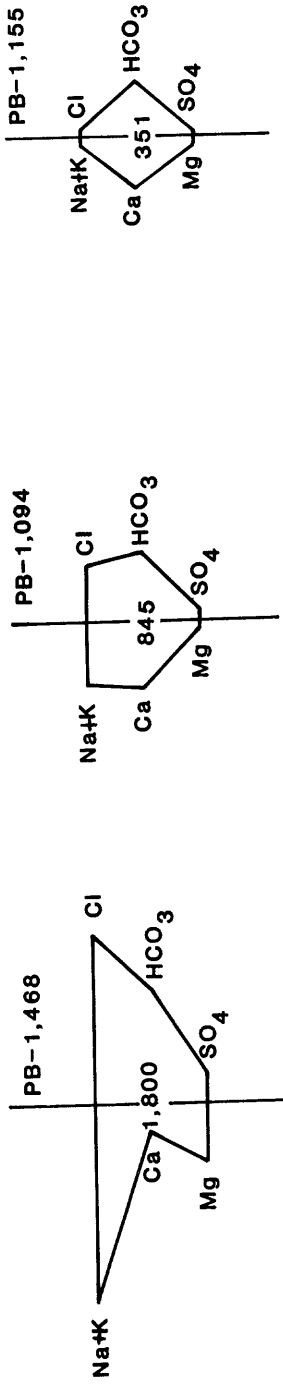

**SURFACE WATER**

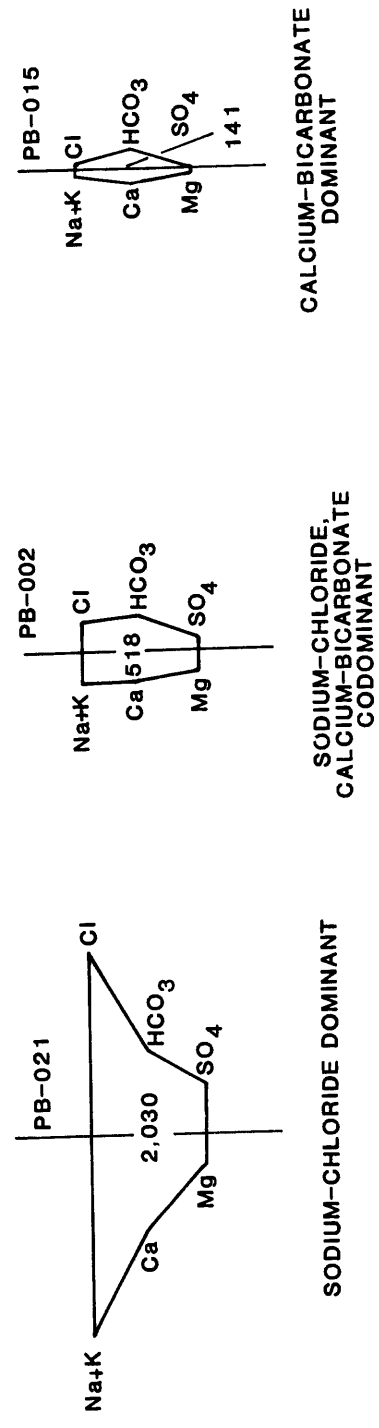

Figure 13.--Chemical composition of ground water and surface water in Palm Beach County, April 1984.



During the April 1984 sampling event, the water table adjacent to the Levee L-8 Canal and reaches of the West Palm Beach and Hillsboro Canals east of Conservation Area No. 1 was above the canal stages (fig. 5), a situation in which water from the surficial aquifer system discharged to the canals. The water table adjacent to the North New River and Miami Canals and reaches of the West Palm Beach and Hillsboro Canals west of the conservation areas was lower than the canal stages. In the latter situation, the canals provided varying amounts of recharge to the surficial aquifer system dependent upon permeabilities of canal bottom sediments and aquifer materials. Steep water-table gradients along these canals and low permeabilities in zone III of the surficial aquifer system (fig. 2) indicate that infiltration from the canals was minimal.

#### West Palm Beach and Levee L-8 Canals

Water-quality analyses (tables 4 and 6 at end of report) were used to prepare Stiff diagrams to relate changes in water composition during April 1984 because of ground-water/surface-water exchange along routes of the West Palm Beach and Levee L-8 Canals from Lake Okeechobee to the coastal area (fig. 14). Samples represented by the diagrams were collected from surface-water sites and shallow (40 to 45 feet) wells and are depicted progressively downstream along the canals. Water was periodically being released from Lake Okeechobee to the West Palm Beach Canal before and during sampling. No water had been released to the Levee L-8 Canal for several weeks prior to sampling.

Surface-water site PB-021, downstream from Lake Okeechobee along the Levee L-8 Canal, had highly mineralized water with a dissolved solids concentration of 2,030 mg/L (table 6 at end of report). The sodium-chloride ion group was dominant (fig. 14) at this site. The absence of water releases from Lake Okeechobee before sampling, combined with direct and indirect ground-water discharges to the canal, suggests this characteristic is indicative of the local ground-water quality. Evaporation from this nearly stagnant reach of the canal also contributed to constituent concentrations. Water from well PB-1467, the nearest well to PB-021 which was sampled, supports this hypothesis. Water between 40 and 45 feet below land surface in the surficial aquifer system at this well had a similar ionic dominance to that found in the canal and was much more highly mineralized. Also, the chloride concentration of 500 mg/L in the water 20 feet below land surface, determined in samples collected during drilling (table 7 at end of report), indicates that the uppermost part of the aquifer system contained highly mineralized water.

Proceeding downstream along the Levee L-8 Canal, analyses of water from wells PB-1462 and PB-1461 showed large changes in the ground water's chemical characteristics. Total mineralization (dissolved solids) of the water in these wells decreased considerably, and an increasing codominance of sodium-chloride calcium-bicarbonate ion groups was evident. Ground-water flow in the vicinity of these wells is to the canal, and the water-quality change is attributable to increased permeabilities and infiltration along the transition of the surficial aquifer system from zone III to zones I and II (fig. 2).

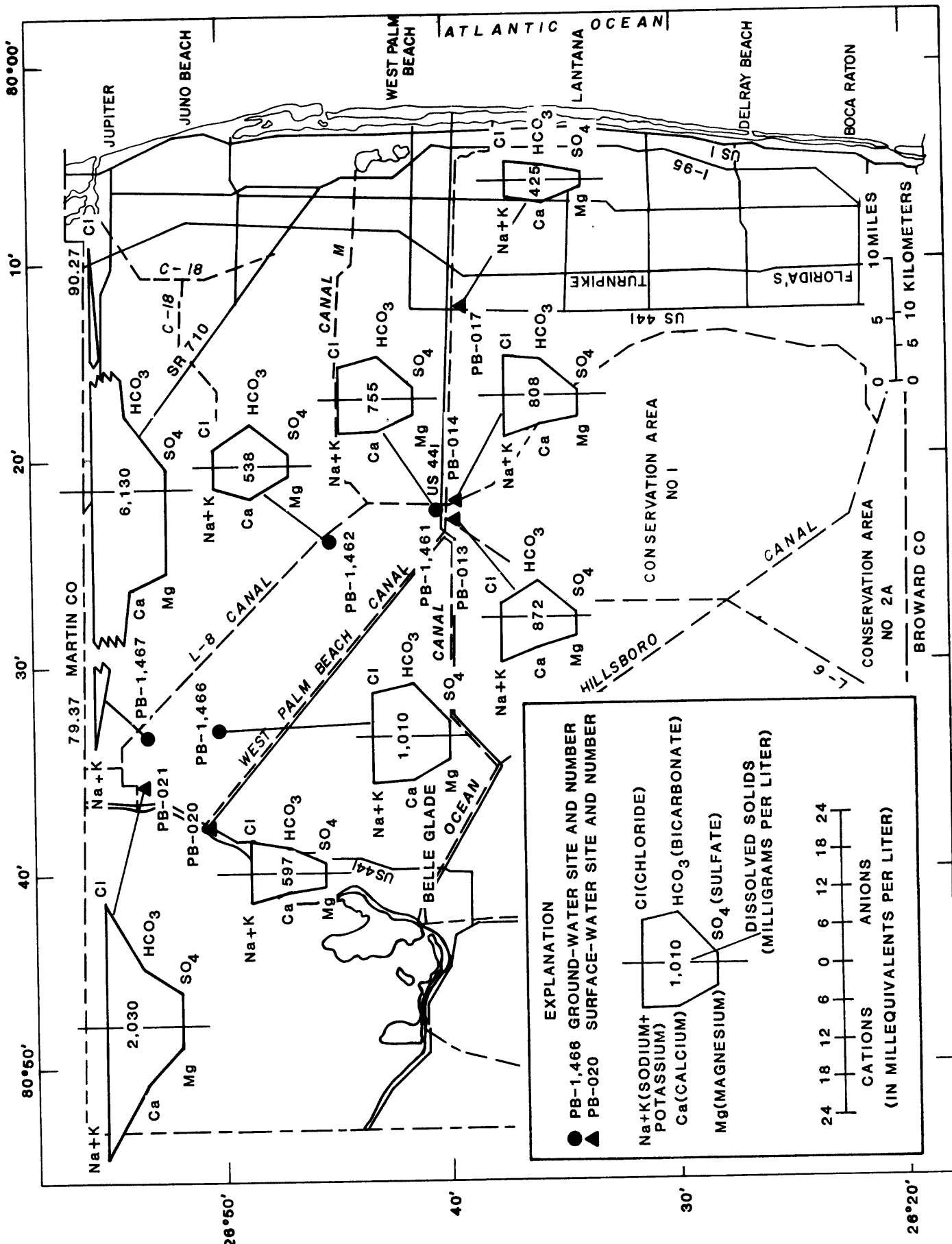

Figure 14.--Chemical composition of water in West Palm Beach and levee L-8 Canals and nearby wells, April 1984.

Immediately downstream from well PB-1461, the Levee L-8 Canal converges with the West Palm Beach Canal through a series of water-control structures. Water samples were collected from the West Palm Beach Canal at two sites above its convergence with the Levee L-8 Canal. The upstream site, PB-020 (fig. 14), was just below the structure through which water was being released to the canal from Lake Okeechobee as the sample was being collected. The downstream site, PB-013, was above the structure at the convergence with the Levee L-8 Canal. The nearest shallow well sampled, PB-1466 (43 feet deep), was downgradient of the canal. At the time of sampling, the canal stage was higher than the water table, and the only ground water entering the canal was by indirect discharges channeled to the canal from the vicinity of well PB-1466.

Between the two canal sampling sites, the water retained a codominance of sodium-chloride calcium-bicarbonate ion groups; chloride concentrations decreased and mineralization increased (fig. 14). The reduction in chloride ion proportions, coupled with increased mineralization along the flow path of the canals, suggests that dissolution of carbonate materials by way of the primary and secondary canal channels had added to mineralization of the water. This is assuming that water quality in well PB-1466 approximates that of any indirect ground-water discharges to the canal, and that such discharges would increase chloride concentrations.

West Palm Beach Canal sampling site PB-014 is immediately below the canal's convergence with the Levee L-8 Canal. Water at the site in April 1984 was a mixture of waters from the Levee L-8 and West Palm Beach Canals and Conservation Area No. 1, which had been released through the water-control structure or had seeped around the structure, and ground-water discharges. The quality and composition of water at the site (fig. 14; table 6 at end of report) represented the cumulative effects of ground-water/surface-water exchange on the source waters between Lake Okeechobee and the sampling site.

Water composition at site PB-014 was similar to that at site PB-020 with a near codominance of sodium-chloride calcium-bicarbonate ion groups, but there was a higher dissolved-solids concentration of 808 mg/L. If water at site PB-013 is representative of the quality of water released to site PB-014 from the West Palm Beach Canal (dissolved-solids concentration of 872 mg/L), then the combined water input from the Levee L-8 Canal and ground water was somewhat less mineralized. Because ground water at well PB-1461 had a dissolved-solids concentration of 755 mg/L, mineralization of water in the lower reach of the Levee L-8 Canal (not sampled) must have been reduced by ground-water discharges to the canal downstream of site PB-021.

When compared to contemporaneous ground-water quality in nearby wells PB-1152, PB-1153, PB-1157, and PB-1460 (table 4 at end of report), canal water at site PB-014 was more highly mineralized. Water quality in these wells was representative of aquifer system zone II water at depths ranging from 30 to 112 feet. If hydrologic conditions had permitted the canal water to infiltrate the more permeable zone of the surficial aquifer system at this time, ground-water mineralization would have been locally increased.

As previously indicated, the water table adjacent to this reach of the West Palm Beach Canal was above the canal stage, and the canal was receiving ground-water discharges during the April 1984 sampling. As a result of ground-water input and surface-water inflows from secondary canals, canal water mineralization decreased downstream from site PB-014. About 10 miles downstream at site PB-017, dissolved solids concentrations in the water had decreased to 425 mg/L. Water at this site had retained the codominant sodium-chloride calcium-bicarbonate ion groups composition of the upstream site.

Analyses of water from other samplings during 1983-84 (tables 4 and 6 at end of report) indicate that these trends in mineralization of ground water and surface water along the routes of the Levee L-8 and West Palm Beach Canals were generally consistent. May 1983 samples varied from others because of unseasonably heavy rains during the sampling which biased the samples. Data were insufficient to determine if ground-water quality changes in previously discussed public supply area No. 4 (fig. 3) have occurred because of water conveyances in the West Palm Beach and Levee L-8 Canals.

#### Hillsboro, North New River, and Miami Canals

The effects of ground-water/surface-water exchange on water composition and quality during conveyance from Lake Okeechobee were similarly examined along the routes of the Hillsboro Canal (fig. 15), the North New River Canal (fig. 16), and the Miami Canal (fig. 17) using analytical results of April 1984 samples. The three canals traverse zone III of the surficial aquifer system (fig. 2), which contains varying quantities of residual seawater (figs. 10-12). No water had been released to the canals from Lake Okeechobee, and no rainfall occurred for several days before the sampling. Indirect ground-water discharges from agricultural dewatering were contributing water to the canals during sampling. Canal stages were at or above the levels of the adjacent water table (fig. 5) in all areas traversed, except the reach of the Hillsboro Canal east of Conservation Area No. 1, preventing direct ground-water discharges to these canals. Of the three canals, only the Hillsboro Canal traverses more permeable zones I and II within Palm Beach County.

Analyses of water from canal sampling sites PB-022, PB-023, and PB-024 (fig. 8) nearest Lake Okeechobee show that dissolved-solids concentrations were near 1,000 mg/L (table 6 at end of report) at the sites. Although Lake Okeechobee water analyses are not available, the large proportion of sodium-chloride ions in the canal water at these sites (figs. 15-17) indicates that residual seawater from the aquifer system had already increased mineralization in water initially released from the lake. Observed flows in all three canals (unmeasured) were downstream, away from Lake Okeechobee, during the April 1984 sampling. In the absence of recent lake releases and rainfalls, the presence of flows in the canals, although minimal, also indicated ground-water discharge in the northern reaches of these canals.

Samples collected at the downstream sites on each of the three canals reflected cumulative water-quality changes, which had occurred along the canal routes from the upstream sites. At site PB-008 on the Hillsboro Canal (fig. 15), dissolved-solids concentrations had been reduced from 1,120 to 590 mg/L, but were still above those at well PB-1100A (table 4 at end of

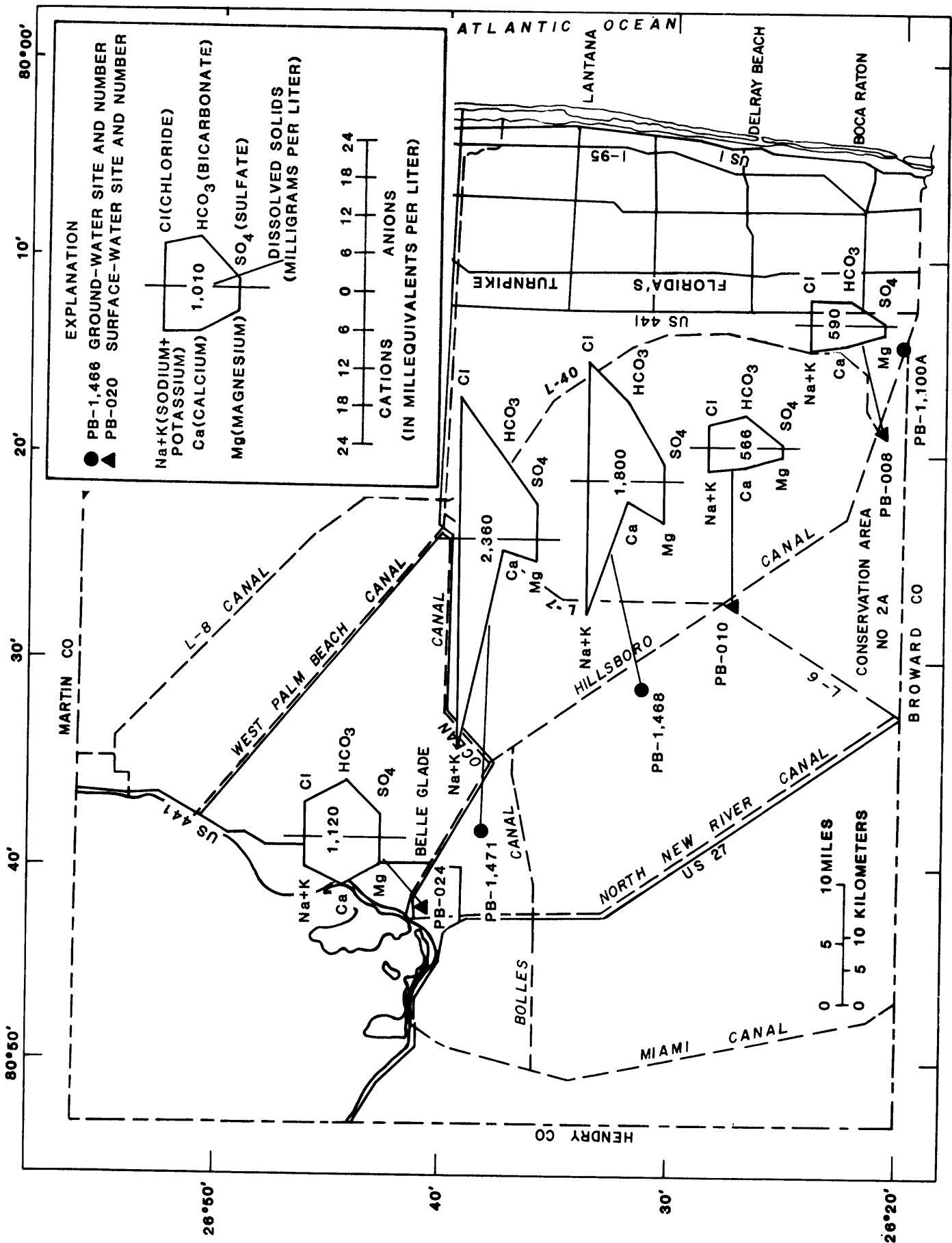

Figure 15.--Chemical composition of water in Hillsboro Canal and nearby wells, April 1984.

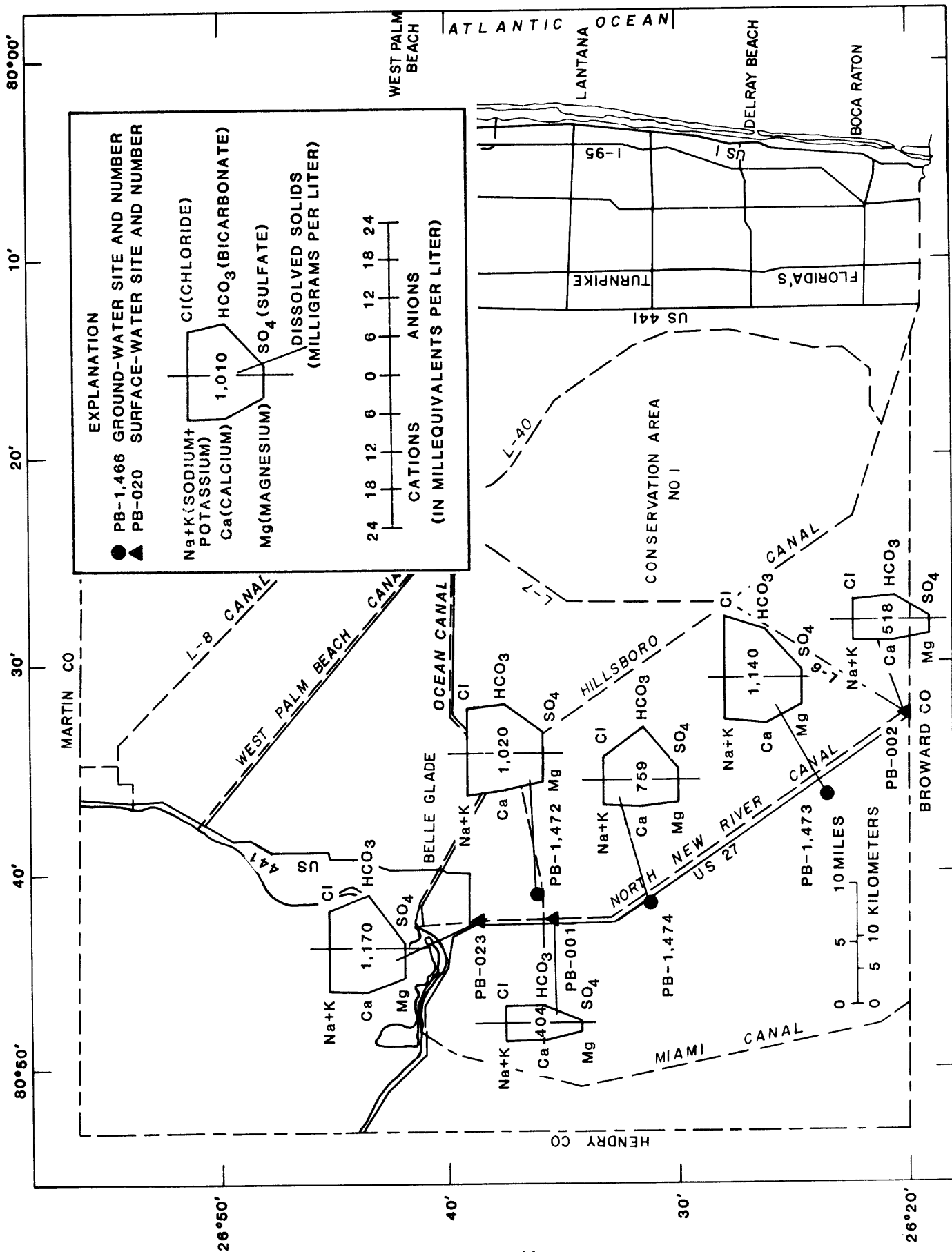

Figure 16.--Chemical composition of water in North New River Canal and nearby wells, April 1984.

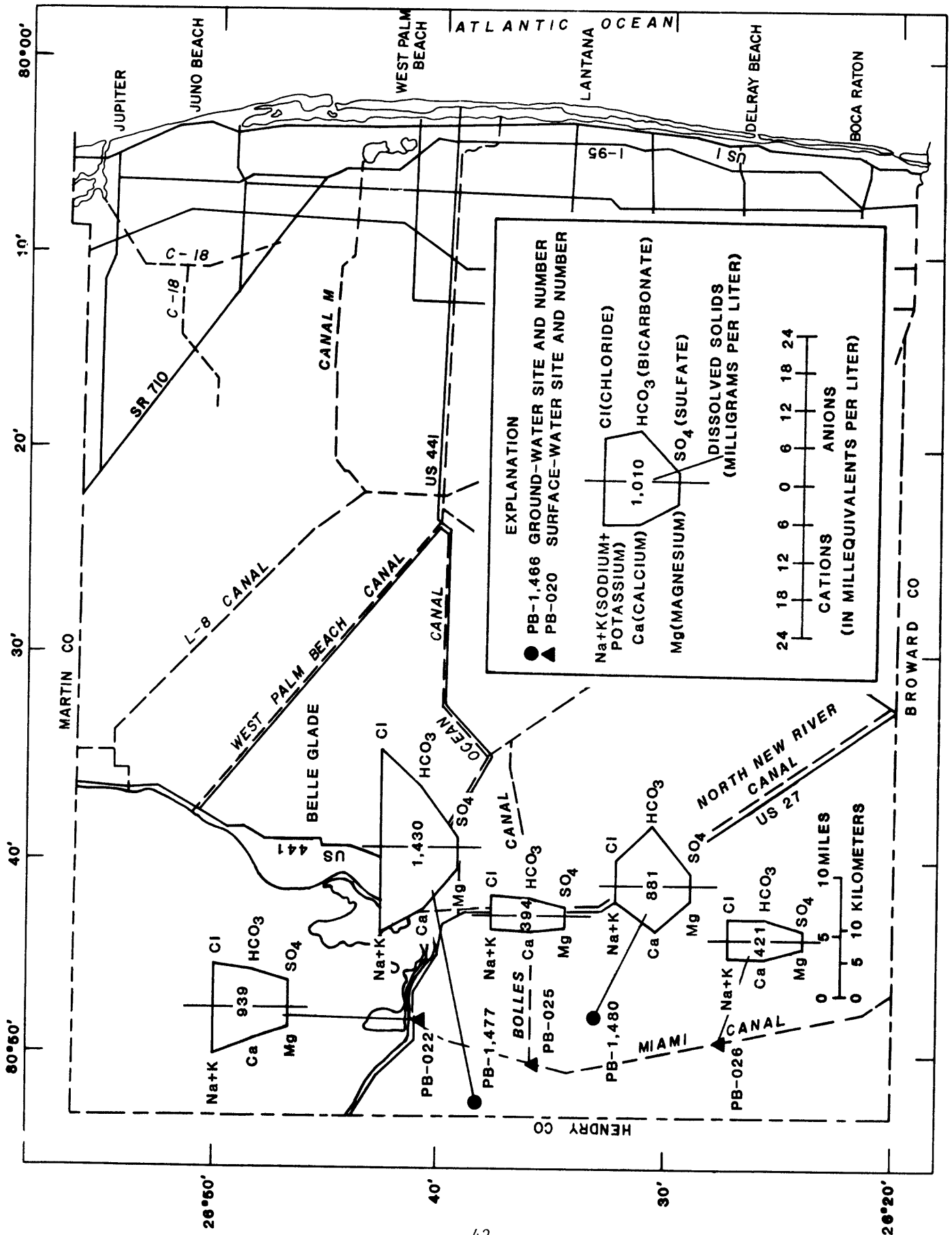

Figure 17.--Chemical composition of water in Miami Canal and nearby wells, April 1984.

report) in zone I of the aquifer system. Similarly, dissolved-solids concentrations at site PB-002 on the North New River Canal and site PB-026 on the Miami Canal were much lower than those at the upstream sites. Stiff diagrams illustrating water compositions at these sites (figs. 15-17) show that a codominance of sodium-chloride calcium-bicarbonate ion groups had developed in all three canals. The water compositions, reductions in dissolved-solids concentrations, and the absence of other water sources indicate that water in the canals had been diluted by less-mineralized ground water between the upstream and downstream sampling sites. Because high canal stages prevented direct ground-water discharges into these canals, the diluting water was provided by indirect discharges from agricultural dewatering.

Water quality (table 4 at end of report) and compositions (figs. 15-17) in wells, ranging in depth from 25 to 45 feet, near the routes of the canals show that ground water from these depths would have increased mineralization if discharged into the canals. However, chloride concentrations in samples collected at various depths during drilling of wells in the area (table 7 at end of report) show that the ground water at shallower depths was less mineralized. If indirect ground-water discharges to the primary canals diluted and improved water quality in the canals, most water provided by agricultural dewatering was from the uppermost part of the aquifer system in these areas. This more recently infiltrated water was less mineralized because of limited contact with residual seawater and geologic materials in the aquifer system. Because of variations in the proximity of residual seawater to land surface (fig. 10), resultant mineralization in the canal water is dependent on the area(s) being dewatered, the quantities of indirect ground water discharged at any particular time, and the contribution of rainfall runoff.

The North New River and Miami Canal are primarily used to convey water south to Broward County (fig. 1) and beyond as well as being used as sources of agricultural irrigation water and receptacles for agricultural drainage. The reduction of mineralization in the canal waters observed along their flow paths (figs. 16 and 17) in April 1984 may, unlike the other canals surveyed, be the exception rather than the rule. Analytical data from other samplings (table 6 at end of report) indicate that canal-water quality was often degraded by increased mineralization along the flow paths. Because of large variations of water quality in the uppermost part of zone III of the surficial aquifer system (fig. 10) and lack of other water sources in the vicinity of the canals, resultant water qualities in these two canals are more dependent upon the locations of agricultural dewatering than other canals surveyed. Determination of the quantities, qualities, and proportions of ground water contributed to the canals along their flow paths by agricultural activities at any particular time is beyond the scope of this investigation.

#### Lake Worth Drainage District Canals

Before the April 1984 sampling, water had periodically been released to the Lake Worth Drainage District (LWDD) canals from Conservation Area No. 1 to maintain canal stages and ground-water levels (fig. 5). The released water was raised by pumpage and initially discharged to the E-1 Canal. The water was then dispersed to the rest of the LWDD canals by combined gravity flow and pumpage. Most of the LWDD is underlain by the most permeable part of the surficial aquifer system, zone I (fig. 2).



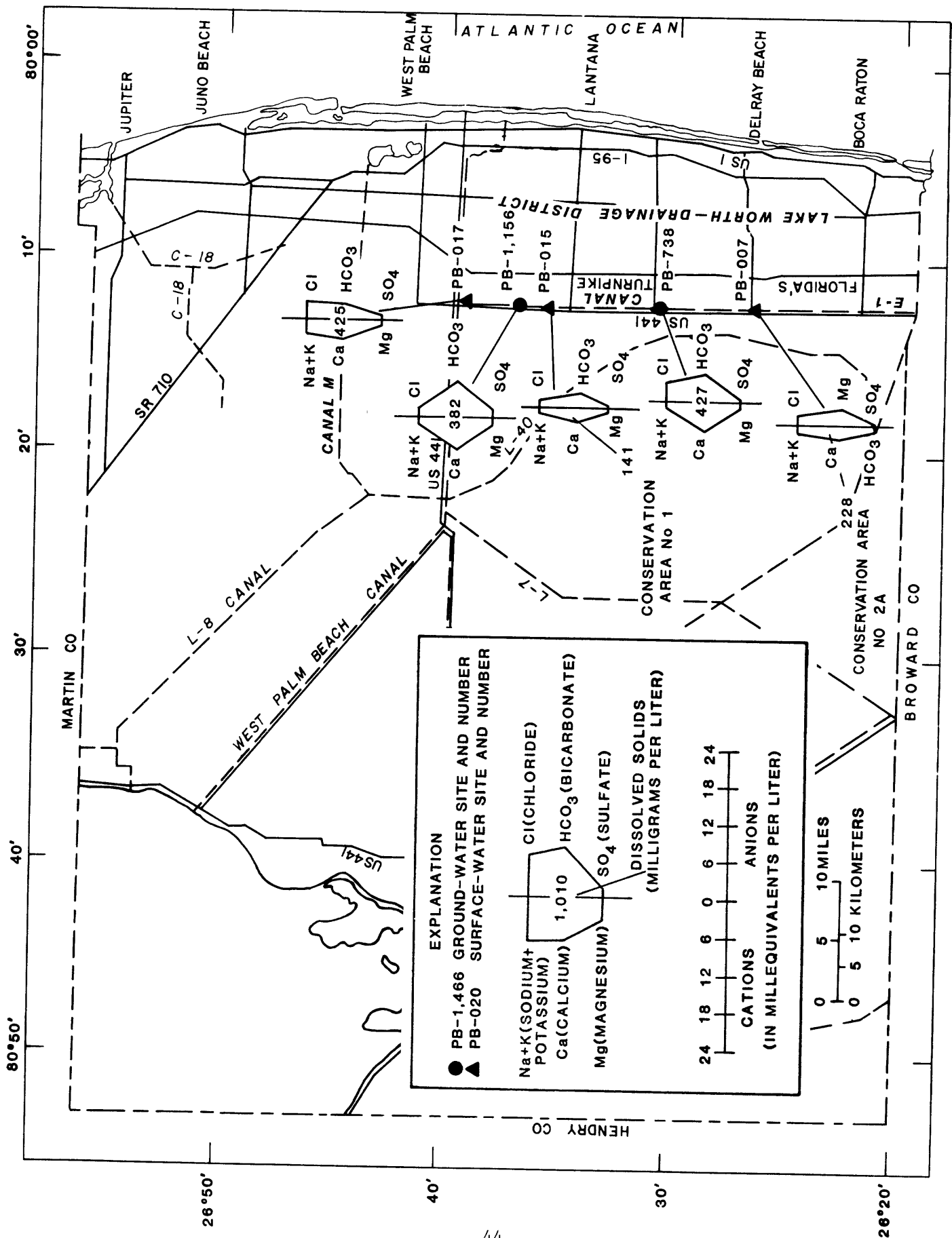

Figure 18.--Chemical composition of water in Lake Worth Drainage District E-1 Canal and nearby wells, April 1984.

Stiff diagrams showing water composition in the E-1 Canal and in adjacent wells (fig. 18) illustrate the effects of ground-water/surface-water exchange as the canal water flowed north from the released point near site PB-007 to its confluence with the West Palm Beach Canal at site PB-017. At the time of sampling (fig. 5), the canal was receiving direct ground-water discharge in the vicinity of surface-water site PB-007 and well PB-738 (24 feet deep) and was recharging the aquifer system in the vicinity of site PB-015 and well PB-1156 (115 feet deep). Although canal water at site PB-007 had already undergone some mixing with ground water after discharge from Conservation Area No. 1, it was less mineralized than water in wells ranging from 24 to 120 feet deep (table 4 at end of report) in the LWDD. At this point in the E-1 Canal, water exhibited a dominance of the calcium-bicarbonate ion group, a water-quality characteristic maintained in the canal water until it was mixed with that of the West Palm Beach Canal at site PB-017 (fig. 18). Ground water in wells near the E-1 Canal and elsewhere throughout the LWDD had a similar ion-species dominance.

Water released from Conservation Area No. 1 to the LWDD canals was generally less mineralized than ground water in the area to which recharge is provided. Water analyses from the April 1984 sampling and other samplings during the investigation gave no indication of eastward migration of highly mineralized water from zone III to zones I and II of the surficial aquifer system as the result of water releases from Conservation Area No. 1 to the LWDD canals. Public supply area No. 1, wholly within the LWDD and previously identified as having a high potential for ground-water quality changes, exhibited no such changes attributable to this water-management practice throughout the investigation.

#### SUMMARY

The investigation to evaluate the effects of increased urban and agricultural development with associated water use and water-management practices on the surficial aquifer system, Palm Beach County, Fla., began in 1982. Objectives of the investigation included determination of changes in ground-water levels, flow directions, and degree of mineralization of water in the aquifer system. Also included in the countywide investigation were: delineation of part of the aquifer system in the central and western parts of the county known to contain residual seawater, and an evaluation of the water's eastward migration.

The principal results and conclusions of the investigation are as follows:

- The water-table aquifer, which is a major source of freshwater in Palm Beach County, and part of which has previously been assigned various names, is a countywide surficial aquifer system extending beyond the confines of the county. The aquifer system is divisible into three hydraulically connected zones on the bases of relative permeabilities and lithologic characteristics. Zone I, generally the most permeable part of the aquifer system with transmissivities ranging from 1,000 to 100,000 ft<sup>2</sup>/d, has well-developed solution cavities in limestones and sandstones. Zone II, somewhat less permeable, is characterized by poorly consolidated, well-sorted sands and shells lacking solution cavities. Zone III, the least permeable part of the aquifer system with some components being virtually

impermeable, is characterized by poorly sorted sediments containing variable amounts of clay- and silt-size particles.

- The two major users of freshwater in Palm Beach County are public supply utilities and agricultural irrigators. Although total water withdrawals by these users increased by about 123 percent and 50 percent, respectively, between 1970 and 1980, ground-water contributions increased to more than 76 percent of public supply withdrawals while having been reduced to about 9 percent of agricultural irrigation withdrawals by 1980. From this, it is inferred that public supply ground-water withdrawals are more likely to precipitate changes of flow direction and water quality in the surficial aquifer system than those of agricultural irrigation. Public supply area No. 1 in the vicinity of Boca Raton and area No. 4 in the vicinity of Royal Palm Beach are the most likely to have already been, or will be, affected by such changes because of public supply ground-water withdrawals.
- Construction of primary canals for flood control and drainage in Palm Beach County beginning in the early 1900's initially lowered ground-water levels in The Everglades, contributing to land subsidence of at least 6 feet in some areas. Structures at the termini of the primary canals held stages above predevelopment levels, increased ground-water levels, and reduced saltwater intrusion along the coast. More recent development of secondary canal networks has allowed extensive control of ground-water levels through regulation of canal stages. Water-table maps of the county, prepared for the years between 1970 and 1981, show minimal ground-water level changes when urban and agricultural expansion more than doubled water use. Ground-water level measurements, made over two dry-wet season cycles in 1983-85, indicate that urban and agricultural areas had average ground-water level fluctuations of less than 2 feet during the investigation.
- Comparison of 1970-81 average flow directions in the aquifer system with those of 1984 indicated that little or no changes had occurred in the predominantly agricultural area. In the urbanized eastern part of the county, variations in ground-water flow directions at least partly attributable to ground-water withdrawals have been identified.
- Water from the surficial aquifer system in central and western Palm Beach County is highly mineralized because of the presence of residual seawater in much of the area. This water was emplaced during high sea levels occurring in interglacial parts of the Pleistocene Epoch. Low permeabilities in zone III of the surficial aquifer system have retarded more complete dilution of the residual seawater by slowing infiltration of fresher waters. Greater permeabilities in zones I and II have permitted dilution of the residual seawater beyond recognition in most of these areas.
- Chloride concentrations in 1983 were mapped for the as much as 20-foot, 20- to 50-foot, and 51- to 100-foot depth intervals of the surficial aquifer system to be consistent with previously prepared maps from the 1941 to 1943 data. Comparison of the maps shows that during the elapsed 40 years both chloride concentrations and extent of area affected have increased for all three depth intervals. In the as much as 20-foot depth interval, chloride concentrations exceeding 200 mg/L were determined to exist in

a large area east and south of Lake Okeechobee. In the 51- to 100-foot depth interval, the areal extent of ground water with chloride concentrations that exceeded 500 mg/L (as high as 5,200 mg/L) had expanded to include most of the western two-thirds of Palm Beach County. Upward migration of diluted residual seawater as a result of agricultural dewatering is the primary cause and is likely to continue.

- Horizontal migration of residual seawater within the aquifer system has been minimal because of low regional ground-water gradients and ground-water divides near the coast. Urban expansion with accompanying increases of ground-water withdrawals may shift the ground-water divides west, allowing increased eastward flow of the residual seawater in the surficial aquifer system.
- Ground water containing residual seawater from zone III of the surficial aquifer system is frequently discharged into primary canals as a result of agricultural drainage procedures. The canals convey water from Lake Okeechobee and the water-conservation areas to coastal areas for canal stage maintenance and aquifer system recharge. Chemical analyses of ground-water and surface-water samples collected in April 1984 near the end of the dry season were used to evaluate the effects of ground-water/surface-water exchange on the quality of water conveyed to zones I and II of the surficial aquifer system by primary canals. Dissolved-solids concentrations in the Levee L-8 Canal and West Palm Beach Canal waters were increased by the addition of ground water from zone III. Although ground-water/surface-water exchange processes had both changed the canal water compositions and reduced mineralization between the upstream and downstream sampling sites, the water was still more highly mineralized than ground water in zones I and II in the vicinity of the canal. Infiltration from the canal could degrade ground-water quality in the more permeable zones of the surficial aquifer system.
- Although 45-foot deep wells adjacent to the Hillsboro Canal contained highly mineralized water exhibiting the effects of residual seawater, canal water mineralization decreased downstream in April 1984. Hillsboro Canal water reaching zone I of the surficial aquifer system was still more mineralized than ground water in the area.
- Although ground-water/surface-water exchange processes reduced mineralization downstream in North New River Canal and Miami Canal waters in April 1984, data from other samplings indicate that an increase in mineralization may be more likely. Resultant water quality in these canals at any time is dependent upon the quantity, quality, and proportions of ground-water discharge to the canals. Ground-water quality in the uppermost part of the surficial aquifer system in zone III varies greatly from location to location in the vicinity of the canals.
- Water withdrawn from Conservation Area No. 1 to maintain stages and provide recharge to the aquifer system in the Lake Worth Drainage District was less mineralized than water from zone I of the surficial aquifer system in the area. During this and other samplings throughout the investigation, there was no indication that this water-management practice had increased ground-water mineralization in the area.

## SELECTED REFERENCES

- Adair and Brady, Inc., 1975, Aquifer and ground-water resource evaluation for the Three Seasons Project, Jupiter, Florida: West Palm Beach, Fla., 32 p.
- Angel, J., 1979, Well-field exploration program in the turnpike aquifer: Barker, Osha, and Anderson, Consulting Engineers, North Palm Beach, Fla., 73 p.
- Brooks, H.K., 1981, Geologic map of Florida: Gainesville, Florida, Cooperative Extension Service, Institute of Food and Agricultural Sciences, University of Florida, 1 sheet.
- Causarás, C.R., 1982, Annotated bibliography of the geology and hydrology of the surficial aquifers in Dade, Broward, and Palm Beach Counties, Florida: U.S. Geological Survey Open-File Report 82-154, 59 p.
- CH<sub>2</sub>M Hill, Inc., 1978, Water-quality studies in the Everglades agricultural area of Florida: Gainesville, Fla., 79 p.
- Clayton, B.S., 1943, Nature and extent of the surface subsidence of the organic soils of the Everglades: The Soil Science Society of Florida, Proceedings, v. 5A, p. 118-125.
- Cooke, C.W., 1945, Geology of Florida: Florida Geological Survey Bulletin 29, 339 p.
- Cooke, C.W., and Mossom, Stuart, 1929, Geology of Florida: Florida Geological Survey 20th Annual Report, p. 29-288.
- Durfor, C.N., and Becker, Edith, 1964, Public water supplies of the 100 largest cities in the United States, 1962: U.S. Geological Survey Water-Supply Paper 1812, 364 p.
- Fischer, J.N., 1980, Evaluation of a cavity-riddled zone of the shallow aquifer near Riviera Beach, Palm Beach County, Florida: U.S. Geological Survey Water-Resources Investigations 80-60, 39 p.
- Florida Coastal Coordinating Council, 1970, Florida coastal zone land use and ownership: Florida Department of Natural Resources, 80 p.
- Freeze, A.R., and Cherry, J.A., 1979, Groundwater: Englewood Cliffs, N.J., Prentice-Hall, Inc., 604 p.
- Galliher, C.F., 1969, Water accounting at pumping station S-5A in Florida: American Society of Civil Engineers, Irrigation and Drainage Division, December 1969, p. 517-524.
- Harrison, D.S., Schuler, K.D., Good, J.M., and Snyder, G.H., 1982, A preliminary study of shallow wells in the eastern Everglades agricultural area: Belle Glade Agricultural Research Education Center, Research Report EV-1892-4, 4 p.
- Hem, J.D., 1970, Study and interpretation of the chemical characteristics of natural water (2d edition): U.S. Geological Survey Water-Supply Paper 1473, 363 p.
- Klein, Howard, and Hull, J.E., 1978, Biscayne aquifer, southeast Florida: U.S. Geological Survey Water-Resources Investigations 78-107, 52 p.
- Land, L.F., 1972, Progress report on water-resources investigations in Palm Beach County, Florida: U.S. Geological Survey Open-File Report FL-72014, 40 p.
- 1975, Effects of lowering interior canal stages on salt-water intrusion into the shallow aquifer in southeast Palm Beach County, Florida: U.S. Geological Survey Open-File Report 75-74, 59 p.

- Land, L.F., 1977, Ground-water resources of the Riviera Beach area, Palm Beach County, Florida: U.S. Geological Survey Water-Resources Investigations 77-47, 38 p.
- Land, L.F., Rodis, H.G., and Schneider, J.J., 1973, Appraisal of the water resources of eastern Palm Beach County, Florida: Florida Bureau of Geology Report of Investigations 67, 64 p.
- Leach, S.D., 1978, Source, use, and disposition of water in Florida, 1975: U.S. Geological Survey Water-Resources Investigations 78-17, 90 p.
- 1982, Source, use, and disposition of water in Florida, 1980: U.S. Geological Survey Water-Resources Investigations 82-4090, 337 p.
- Leach, S.D., and Healy, H.G., 1979, Estimated water use in Florida, 1977: U.S. Geological Survey Water-Resources Investigations 79-112, 76 p.
- Mansfield, W.C., 1931, Pliocene fossils from limestone in southern Florida: U.S. Geological Survey Professional Paper 170, p. 43-58.
- 1939, Notes on the upper Tertiary and Pleistocene mollusks of peninsular Florida: Florida Geological Survey Bulletin 18, 75 p.
- Matson, G.C., and Clapp, F.G., 1909, A preliminary report on the geology of Florida: Florida Geological Survey 2d Annual Report, p. 24-173.
- McCoy, H.G., and Hardee, Jack, 1970, Ground-water resources of the lower Hillsboro Canal area, southeastern Florida: Florida Bureau of Geology Report of Investigations 55, 44 p.
- McPherson, B.F., and Sabanskas, Maryann, 1980, Hydrologic and land-cover features of the Loxahatchee River basin, Florida: U.S. Geological Survey Water-Resources Investigations Open-File Report 80-1109, 1 sheet.
- McPherson, B.F., Sabanskas, Maryann, and Long, W.A., 1982, Physical, hydrological, and biological characteristics of the Loxahatchee River estuary, Florida: U.S. Geological Survey Water-Resources Investigations Open-File Report 82-350, 1 sheet.
- Meeder, J.F., 1979, The Pliocene fossil reef of southwest Florida: Miami Geological Society Field Guide, 19 p.
- Meyer, F.W., 1971, Seepage beneath Hoover Dike, southern shore of Lake Okeechobee, Florida: Florida Bureau of Geology Report of Investigations 58, 98 p.
- Miller, W.L., 1985a, Altitude of water table, surficial aquifer, Palm Beach County, Florida, April 24-26, 1984: U.S. Geological Survey Open-File Report 85-336, 1 sheet.
- 1985b, Altitude of water table, surficial aquifer, Palm Beach County, Florida, November 9-14, 1984: U.S. Geological Survey Open-File Report 85-637, 1 sheet.
- 1986, Lithology and base of the surficial aquifer system, Palm Beach County, Florida: U.S. Geological Survey Water-Resources Investigations 86-4067, 2 sheets.
- Miller, W.L., and Alvarez, J.A., 1984, Public supply water use, Palm Beach County, Florida, 1978-82: U.S. Geological Survey Open-File Report 84-240, 14 p.
- Miller, W.L., and Lietz, A.C., 1976, Quality-of-water data, Palm Beach County, Florida, 1970-75: U.S. Geological Survey Open-File Report 76-784, 100 p.
- Olson, A.A., and Harbison, Anne, 1953, Pliocene mollusca of southern Florida: Academy of Natural Science of Philadelphia, Monograph 8, p. 2-26.
- Olson, A.A., and Petit, R.E., 1968, Some Neogene mollusks from Florida and the Carolinas: Bulletin of American Paleontology, v. 47, no. 217, p. 509-575.

- Palm Beach County Department of Planning, Building, and Zoning, 1980: Comprehensive Plan, 83 p.
- Parker, G.G., and Cooke, C.W., 1944, Late Cenozoic geology of southern Florida, with a discussion of the ground water: Florida Geological Survey Bulletin 27, 119 p.
- Parker, G.G., Ferguson, G.E., and Love, S.K., 1944, Interim report on the investigations of water resources in southeastern Florida with special reference to the Miami area in Dade County, Florida: Florida Geological Survey Report of Investigations 4, 39 p.
- Parker, G.G., Ferguson, G.E., Love, S.K., and others, 1955, Water resources of southeastern Florida, with special reference to geology and ground water of the Miami area: U.S. Geological Survey Water-Supply Paper 1255, 965 p.
- Parker, G.G., and Hoy, N.D., 1943, Additional notes on the geology and ground water of southern Florida: Soil Science Society of Florida, Proceedings, v. 5A, p. 33-55.
- Petuch, E.J., 1982, Notes on the molluscan paleoecology of the Pinecrest Beds at Sarasota, Florida: Proceedings of the Academy of Natural Sciences of Philadelphia 134, p. 12-30.
- Pitt, W.A.J., Jr., and Meyer, F.W., 1976, Ground-water quality at the site of a proposed deep-well injection system for treated wastewater, West Palm Beach, Florida: U.S. Geological Survey Open-File Report 76-91, 43 p.
- Preble, G.H., 1883, A quarterly review of Naval affairs: United Service, p. 358-376.
- Pride, R.W., 1972, Estimated use of water in Florida, 1970: U.S. Geological Survey Open-File Report FL-72021, 52 p.
- Rodis, H.G., 1973, Encroaching salt water in northeast Palm Beach County, Florida: Florida Bureau of Geology Map Series 59.
- Rodis, H.G., and Land, L.F., 1976, The shallow aquifer--a prime freshwater resource in eastern Palm Beach County, Florida: U.S. Geological Survey Water-Resources Investigations 76-21, 12 p.
- Sanford, Samuel, 1909, Topography and geology of southern Florida: Florida Geological Survey 2nd Annual Report, p. 177-231.
- Schmoker, J.W., Halley, R.B., Meyer, F.W., and Robbins, S.L., 1979, Preliminary porosity estimates of south Florida Cenozoic carbonate rocks based on borehole gravity measurements: U.S. Geological Survey Open-File Report 79-1652, 17 p.
- Schneider, J.J., 1973, Effects on water quality in the shallow aquifer due to the operation of the Cross State Dump, Palm Beach County, Florida: U.S. Geological Survey Open-File Report FL-73011, 42 p.
- 1976, Geologic data from test drilling in Palm Beach County, Florida since 1970: U.S. Geological Survey Open-File Report 76-713, 99 p.
- 1977, Water-table contours in Palm Beach County, Florida, October 5-6, 1976: U.S. Geological Survey Open-File Report 77-364, 1 sheet.
- Schroeder, M.C., Milliken, D.L., and Love, S.K., 1954, Water resources of Palm Beach County, Florida: Florida Geological Survey Report of Investigations 13, 63 p.
- Scott, W.B., 1977, Hydraulic conductivity and water quality of the shallow aquifer, Palm Beach County, Florida: U.S. Geological Survey Water-Resources Investigations 76-119, 22 p.
- Scott, W.B., Land, L.F., and Rodis, H.G., 1977, Saltwater intrusion in the shallow aquifer in Palm Beach and Martin Counties, Florida: U.S. Geological Survey Water-Resources Investigations 76-135.

- Sellards, E.H., 1912, The soils and other residual materials of Florida: Florida Geological Survey 4th Annual Report, p. 7-79.
- 1919, Geologic section across the Everglades: Florida Geological Survey 12th Annual Report, p. 67-76.
- Shampine, W.J., 1975, Dissolved solids in water from the upper part of the Floridan aquifer in Florida (2d ed.): Florida Bureau of Geology Map Series 14.
- South Florida Water Management District, 1981, The 1981 water shortage, May 6, 1981-September 11, 1981: South Florida Water Management District, 127 p.
- Stiff, H.A., Jr., 1951, The interpretation of chemical water analyses by means of patterns: Journal of Petroleum Technology, v. 3, no. 10, p. 15-17.
- Stringfield, V.T., 1933, Ground water in Lake Okeechobee area, Florida: Florida Geological Survey Report of Investigations 2, 31 p.
- Swayze, L.J., McGovern, M.D., and Fischer, J.N., 1981, Lithologic logs and geophysical logs from test drilling in Palm Beach County, Florida, since 1974: U.S. Geological Survey Open-File Report 81-68, 93 p.
- Swayze, L.J., and Miller, W.L., 1984, Hydrogeology of a zone of secondary permeability in the surficial aquifer of eastern Palm Beach County, Florida: U.S. Geological Survey Water-Resources Investigations 83-4249, 39 p.
- Taylor, D.W., 1966, Summary of North American Blancan nonmarine mollusks: Malacologia, v. 4, no. 4, p. 106-116.
- Todd, D.K., 1967, Ground water hydrology: New York, John Wiley, 336 p.
- University of Florida, 1981a, Florida estimates of population: Bureau of Economic and Business Research, University of Florida, 43 p.
- 1981b, Florida statistical abstract: Bureau of Economic and Business Research, University of Florida, 695 p.
- 1984, Florida estimates of population: Bureau of Economic and Business Research, University of Florida, 45 p.
- Waller, B.G., 1985, Drought of 1980-82 in southeast Florida with comparison to the 1961-62 and 1970-71 droughts: U.S. Geological Survey Water-Resources Investigations 85-4152, 29 p.



Table 4.--Concentrations of major inorganic constituents and related chemical characteristics of ground water

[Concentrations shown in milligrams per liter, except for specific conductance which is in microsiemens per centimeter and color which is in platinum-cobalt units. Dissolved solids, residue at 180 degrees Celsius; --, data not available.]

Local well number	Date of collection	Calcium (Ca)	Magnesium (Mg)	Sodium (Na)	Potassium (K)	Specific conductance	Chloride (Cl)	Sulfate (SO <sub>4</sub> )	Fluoride (F)	Color	pH (units)	Bicarbonate (HCO <sub>3</sub> )	Dissolved solids	Silica (SiO <sub>2</sub> )
<u>Zone I</u>														
PB-671	10/14/83	91	3.4	26	1.1	565	48	0.1	0.4	50	8.0	284	358	13
	4/17/84	90	3.6	27	1.2	570	47	.1	.3	60	7.3	278	349	13
PB-738	10/14/83	110	3.9	27	1.8	645	80	.1	.4	80	8.1	272	450	14
	4/16/84	97	3.6	34	1.9	610	79	<.1	.4	80	7.6	256	427	13
	11/13/84	93	3.2	44	1.5	610	57	.1	.4	140	7.2	264	388	13
PB-845	10/20/83	110	3.7	18	.7	590	22	7.2	.4	40	8.3	352	371	13
	4/18/84	100	3.6	22	.7	580	27	13	.3	40	7.6	336	360	12
PB-1084	10/21/83	260	93	980	35	6,350	1,700	420	.4	80	7.9	656	4,050	20
	4/18/84	260	99	1,200	35	6,800	1,800	460	.4	90	7.3	628	4,330	20
	11/15/84	260	92	1,000	32	6,330	1,700	390	.3	85	7.7	630	4,000	7.1
PB-1085	10/21/83	93	6.3	41	1.8	630	67	5.2	.3	10	7.9	284	411	17
	4/18/84	87	6.4	40	1.8	640	67	4.6	.2	40	7.3	296	382	18
	11/15/85	94	6.8	44	2.2	694	69	9	.3	40	7.8	300	408	18
PB-1089	11/22/83	120	6.3	52	1.9	810	93	6.4	.2	40	7.4	358	500	16
	4/17/84	110	6.1	53	1.7	780	85	4.8	.3	40	7.6	358	495	16
	11/16/84	50	3.0	23	2.8	102	35	.2	.2	120	7.4	151	218	7.1
PB-1094	4/20/84	130	11	140	7.7	1,420	190	46	.3	100	7.7	475	845	16
	11/13/84	130	22	140	7.8	1,370	200	34	.4	100	7.2	440	842	16
PB-1096	4/16/84	90	2	16	1.2	488	25	<.1	.5	40	7.6	284	300	17
	11/13/84	94	1.7	16	1.1	500	27	.1	.3	50	7.1	282	312	17
PB-1097	4/17/84	120	8.0	52	3.5	770	53	20	.4	70	7.6	420	512	18
	11/8/84	130	8.1	50	3.6	805	65	17	.4	60	7.4	420	512	15
PB-1099	11/8/83	250	79	710	26	4,750	1,100	370	.3	60	7.9	652	2,811	21
	4/24/84	230	80	700	22	4,580	1,100	370	.3	100	7.5	664	2,853	21
PB-1100A	10/20/83	140	5.2	49	2.5	850	77	2.2	.4	5	7.9	427	552	17
	4/27/84	130	4.8	41	1.9	840	71	<.1	.3	20	7.4	453	508	17
	11/7/84	150	3.5	23	.8	770	43	4.7	.4	20	7.4	450	484	16
PB-1101	10/24/83	87	1.9	21	1.0	465	33	11	.7	5	8.0	208	314	14
	4/27/84	86	2.0	19	1.1	--	34	22	.2	20	7.1	242	321	18
	11/7/84	100	1.7	22	1.1	520	32	30	.3	20	7.2	270	346	20
PB-1104	10/24/83	110	2.3	20	.7	590	37	.1	.3	40	8.0	334	385	11
	4/27/84	110	2.5	21	.6	600	38	.1	.3	60	7.6	336	383	12
PB-1105	10/19/83	120	3.4	22	1.0	670	35	2.4	.4	5	8.1	400	430	14
	4/16/84	130	3.8	20	1.1	680	35	.4	.4	30	7.6	410	431	16
PB-1107	4/17/84	150	5.8	120	3.5	1,140	170	16	.4	120	7.6	440	771	16
	11/8/84	150	5.9	120	2.3	1,220	180	16	.4	100	7.4	480	762	16
PB-1108	4/17/84	120	11	90	2.8	1,010	130	8.4	.5	90	7.6	418	650	16
	11/8/84	85	85	73	3.8	830	99	12	.6	140	7.6	350	514	17
PB-1155	10/14/83	100	3.6	21	1.1	560	39	.1	.3	50	7.7	324	365	13
	4/7/84	100	3.5	20	.9	570	31	.3	.3	60	7.4	327	351	12
	11/13/84	100	3.7	22	.9	580	49	.1	.4	60	7.4	340	366	12
PB-1156	10/14/83	110	3.9	24	1.1	630	38	.6	.2	30	8.1	352	405	14
	4/17/84	110	4.3	24	1.0	620	37	1.2	.2	40	7.8	356	382	14
	11/13/84	110	4.0	24	1.0	620	39	.8	.4	40	7.5	360	388	13
<u>Zone II</u>														
PB-689	10/15/83	47	4.3	17	.7	328	22	.1	.3	20	8.0	191	187	4.8
	4/28/84	77	4.2	17	.5	446	22	.1	.4	20	7.9	256	276	16
	11/15/84	45	3.9	18	.8	312	22	.4	.3	10	7.7	160	174	2.3
PB-717	10/25/83	58	3.9	19	1.5	398	25	.1	.2	10	7.9	215	222	1.5
	4/18/84	76	4.4	18	.7	660	24	.3	.3	20	7.0	272	276	.7
	11/15/84	37	3.5	20	1.2	286	21	.1	.2	50	7.6	140	158	1.2
PB-718	10/25/83	83	1.9	13	0.6	453	24	.5	.5	30	7.9	253	284	10
	4/18/84	92	2.8	19	.9	510	21	.2	.4	50	7.4	292	280	11
	11/16/84	78	3.0	28	1.2	489	32	.1	.5	30	7.5	236	270	8.4
PB-752	11/2/83	31	1.2	14	4.5	233	32	27	.3	560	6.8	46	218	3.2
	4/16/84	23	.9	14	3.6	160	15	13	.3	900	6.4	58	190	3.0
	11/7/84	31	1.3	7.4	3.5	195	18	19	.3	560	6.4	55	190	3.2
PB-789	10/25/83	110	2.5	23	.4	606	31	.4	.2	30	8.1	348	374	15
	4/18/84	100	2.6	20	.5	--	28	.6	.1	40	7.4	326	342	14
	11/15/84	65	2.1	21	1.4	413	30	.4	.2	15	7.6	190	--	2.1
PB-1098	10/25/83	98	9.0	52	2.9	740	82	5.6	.3	10	7.9	336	469	17
	4/24/84	99	9.1	48	2.6	730	79	4.8	.3	40	7.6	341	450	18
	11/16/84	96	7.1	31	2.5	679	53	.1	.2	30	7.8	320	388	16
PB-1109A	10/21/83	190	64	520	23	3,750	860	180	.4	60	8.1	620	2,360	26
	4/18/84	190	59	580	12	3,400	840	230	.3	60	7.1	585	2,240	23
PB-1152	10/17/83	140	8.9	64	2.8	950	110	6.3	.3	20	7.7	410	582	17
	4/17/84	130	8.6	65	2.8	930	110	5.5	.2	40	7.4	430	580	17
	11/13/84	160	19	27	4.1	955	28	140	.4	40	7.5	460	642	17

Table 4.--Concentrations of major inorganic constituents and related chemical characteristics of ground water--Continued

Local well number	Date of collection	Calcium (Ca)	Magnesium (Mg)	Sodium (Na)	Potassium (K)	Specific conductance	Chloride (Cl)	Sulfate (SO <sub>4</sub> )	Fluoride (F)	Color	pH (units)	Bicarbonate (HCO <sub>3</sub> )	Dissolved solids	Silica (SiO <sub>2</sub> )
<u>Zone II--Continued</u>														
PB-1153	10/17/83	150	17	25	3.6	890	25	120	0.2	20	7.7	400	598	17
	4/17/84	150	18	25	3.9	880	27	150	.3	30	7.5	400	635	17
	11/13/84	160	19	27	--	905	28	140	.4	40	7.5	--	642	17
PB-1157	10/19/83	100	6.9	28	1.7	640	46	.5	.2	30	8.0	334	399	16
	4/17/84	100	6.8	28	1.6	630	48	<.1	.2	40	7.4	336	271	16
	11/16/84	83	3.8	11	.6	429	22	.6	.2	75	7.7	260	282	8.3
PB-1460	10/17/83	130	6.2	12	1.1	650	18	.6	.2	60	7.7	412	426	13
	4/19/84	120	5.2	13	.8	610	21	.4	.3	70	7.5	368	388	12
	11/19/84	110	5.2	24	2.2	638	39	1.4	.3	70	7.6	355	402	11
PB-1461	10/13/83	100	31	130	6.7	1,310	190	69	.4	100	7.7	436	853	23
	4/19/84	100	28	130	5.9	1,190	170	62	.4	100	7.4	386	755	22
	11/19/84	89	27	120	6.2	1,190	160	46	.4	80	7.7	370	698	20
<u>Zone III</u>														
PB-836	4/20/84	100	34	110	8.1	1,410	160	110	1.0	200	8.1	324	838	19
	11/19/84	120	44	140	8.8	1,470	800	97	1.2	320	7.8	480	948	23
PB-843	4/21/84	120	80	600	23	3,580	720	410	.6	70	7.7	700	2,390	38
	11/16/84	120	76	530	19	3,580	580	330	.7	70	7.8	690	2,030	37
PB-1462	10/13/83	160	32	130	13	1,580	280	67	.2	30	7.8	408	968	20
	4/19/84	100	18	60	6.7	850	83	30	.4	50	7.4	386	538	19
	11/15/84	140	26	120	10	1,140	200	53	.2	40	7.9	283	770	19
PB-1463	11/2/83	92	70	190	14	1,740	270	70	1.8	120	8.0	604	1,130	32
	4/20/84	100	58	190	14	2,000	250	75	1.6	160	7.7	596	1,120	33
	11/15/84	110	75	820	22	--	1,200	120	2.1	120	8.0	812	2,820	33
PB-1464	10/31/83	130	88	410	14	2,780	460	220	2.1	280	8.2	853	2,010	56
	4/20/84	130	85	480	14	2,950	520	210	1.8	240	7.9	890	2,090	56
	11/9/84	130	74	380	12	2,470	440	180	2.1	240	7.6	516	1,790	53
PB-1465	10/31/83	190	120	1,200	36	7,100	1,700	420	1.3	200	8.1	1,130	4,590	86
	4/20/84	210	150	1,300	30	7,000	1,800	420	1.0	200	7.6	1,148	4,570	90
	11/15/84	180	130	1,200	31	7,010	1,700	410	1.1	200	7.9	1,130	4,380	97
PB-1466	10/31/83	110	38	160	11	1,460	220	91	1.0	160	8.1	476	979	34
	4/19/84	130	40	170	6.2	1,470	220	98	1.4	160	7.7	500	1,010	36
	11/16/84	120	37	160	13	1,560	220	100	1.0	160	7.9	508	920	39
PB-1467	10/31/83	340	140	1,700	41	9,980	3,100	140	.5	60	8.0	671	6,270	26
	4/19/84	320	150	1,800	42	9,900	3,200	150	.4	60	7.6	632	6,130	27
	11/15/84	300	140	1,700	36	10,200	3,200	160	.4	60	7.9	660	6,090	27
PB-1468	11/1/83	76	76	460	19	2,900	600	76	1.8	80	8.4	688	1,700	30
	4/23/84	75	80	470	18	3,150	620	100	1.7	80	7.7	725	1,800	31
	11/8/84	72	73	480	19	2,990	600	86	2.0	90	8.0	720	1,750	32
PB-1469	10/27/83	95	80	170	11	1,640	190	25	1.3	60	8.3	780	1,030	39
	4/21/84	94	85	160	11	1,600	180	26	1.2	70	7.7	784	1,040	39
	11/7/84	96	75	170	11	1,630	180	22	1.3	70	8.1	779	986	39
PB-1470	10/27/83	110	84	280	12	2,200	380	32	1.3	80	8.2	784	1,330	32
PB-1471	11/1/83	43	43	830	24	4,200	880	190	2.1	60	8.5	799	2,560	39
	4/20/84	38	43	760	20	2,800	770	240	.7	60	7.8	814	2,360	41
	11/9/84	48	58	510	21	2,800	460	220	2.3	60	8.3	--	1,700	41
PB-1472	10/27/83	110	54	150	6.8	1,460	210	140	1.3	80	8.2	482	1,010	30
	4/20/84	120	52	140	5.7	1,430	220	150	1.1	90	7.5	460	1,020	29
	11/7/84	98	41	94	5.4	1,140	140	90	1.3	120	7.9	390	732	29
PB-1473	10/12/83	140	60	350	7.3	2,600	580	35	1.3	30	7.9	605	1,530	24
	4/24/84	150	52	160	4.6	1,760	350	40	1.2	40	7.6	459	1,140	21
	11/6/84	130	48	212	4.4	1,720	320	39	1.2	50	7.7	480	960	21
PB-1474	10/27/83	94	48	82	8.9	1,120	120	63	1.1	80	8.0	490	728	21
	4/20/84	96	48	92	8.0	1,160	120	72	1.1	80	7.8	488	759	22
	11/6/84	98	40	88	7.7	1,070	140	82	.9	80	8.1	400	764	22
PB-1475	10/27/83	110	36	71	4.0	1,050	120	69	.9	80	8.0	440	697	16
	4/21/84	100	34	77	3.5	1,070	120	69	.8	70	7.6	408	695	15
	11/7/84	120	35	77	5.3	1,090	120	120	1.0	100	8.2	405	763	15
PB-1476	10/27/83	120	34	75	2.8	1,070	110	99	.9	100	7.6	406	739	15
	4/20/84	120	34	72	4.9	1,060	110	98	.9	100	7.5	390	698	30
	11/7/84	120	34	72	4.7	2,410	530	40	.3	10	7.8	512	1,540	22
PB-1477	10/28/83	220	32	290	4.0	2,250	520	44	.1	10	7.0	568	1,430	22
	4/21/84	200	33	300	4.0	2,250	520	44	.1	10	7.5	620	1,540	22
	11/7/84	230	33	290	4.3	2,550	530	240	.2	10	7.5	512	843	19
PB-1478	10/28/83	160	34	66	3.5	1,190	120	76	1.0	100	8.2	512	821	19
	4/21/84	150	35	81	3.7	1,240	130	67	.9	100	7.6	528	821	19
	10/31/83	150	100	1,600	41	7,800	1,900	580	.9	50	7.9	1,056	4,910	62
PB-1479	4/20/84	140	100	1,600	40	7,800	1,900	630	.7	60	7.8	1,304	4,940	64
	11/9/84	140	100	1,600	38	7,850	2,000	550	.7	40	8.0	874	4,900	68
PB-1480	10/28/83	160	32	59	4.2	1,100	100	82	.9	140	7.9	508	826	12
	4/23/84	150	26	68	14	1,230	130	70	.8	140	7.6	510	881	12
	11/6/84	180	32	90	3.9	1,230	160	65	.8	140	7.7	450	948	13

Table 4.--Concentrations of major inorganic constituents and related chemical characteristics of ground water--Continued

Local well number	Date of collection	Calcium (Ca)	Magnesium (Mg)	Sodium (Na)	Potassium (K)	Specific conductance	Chloride (Cl)	Sulfate (SO <sub>4</sub> )	Fluoride (F)	Color	pH (units)	Bicarbonate (HCO <sub>3</sub> )	Dissolved solids	Silica (SiO <sub>2</sub> )
<u>Zone III--Continued</u>														
PB-1481	10/13/83	280	290	3,800	130	1,600	5,600	1,600	0.8	100	8.1	856	12,300	32
	4/19/84	480	650	6,000	200	28,500	9,500	2,800	.7	40	7.6	802	20,400	52
	11/8/84	430	550	6,100	220	29,600	9,400	2,500	.6	40	7.9	900	20,300	59
PB-1482	10/31/83	200	850	5,100	240	28,000	9,400	1,600	.8	80	7.8	1,164	18,600	32
	4/19/84	220	400	6,100	200	27,800	9,400	1,600	.7	80	7.7	1,137	19,000	32
	11/15/84	180	410	6,400	230	29,000	9,400	1,600	.6	80	7.8	1,170	19,000	33
PB-1483	10/13/83	180	350	5,600	210	25,600	8,700	1,100	.8	20	7.7	722	16,500	32
	4/24/84	230	350	6,100	220	28,000	9,600	1,300	.6	20	7.6	952	18,560	37
	11/8/84	240	380	6,300	210	28,600	9,600	1,200	.6	40	7.8	980	18,600	39
PB-1484	10/28/83	800	280	3,400	150	18,000	5,100	3,400	.4	20	7.8	668	13,800	43
	4/23/84	900	320	3,500	150	19,000	5,300	3,200	.3	20	7.4	696	14,000	48
	11/16/84	850	280	3,800	170	19,900	5,400	3,100	.2	20	7.7	700	14,400	54
PB-1485	10/12/83	160	170	2,800	120	14,100	4,500	660	.7	20	8.0	680	8,900	33
	4/23/84	160	170	2,600	110	13,000	4,200	650	.7	20	7.5	724	8,570	34
	11/6/84	150	160	2,900	120	14,400	4,200	640	.7	20	7.7	760	8,660	34
PB-1486	10/28/83	170	150	2,400	150	12,200	3,600	850	.3	20	8.0	426	7,590	21
	4/23/84	170	170	2,700	120	13,400	4,200	920	.5	20	7.8	665	8,710	38
	11/6/84	170	160	2,800	120	14,000	4,100	880	.3	30	7.8	604	8,600	34

<sup>1</sup>Casing broken.

Table 5.--Chloride concentrations at selected wells in the surficial aquifer system,  
Palm Beach County, October 1983 through November 1984

Concentrations shown in milligrams per liter; --, data not available.]

Sampling station and local well number	October 24 to November 10, 1983	April 6-25, 1984	November 9-20, 1984
<u>Zone I</u>			
PB-88	8	10	8
PB-445	35	35	35
PB-563	10	15	--
PB-683	45	45	45
PB-719	20	20	--
PB-750	340	345	340
PB-751	50	50	45
PB-936	20	24	--
PB-1100B	50	46	50
<u>Zone II</u>			
PB-99	25	30	25
PB-566	25	26	--
PB-618	15	14	--
PB-684	10	10	10
PB-685	20	20	--
PB-687	11	--	--
PB-711A	46	--	--
PB-711B	25	24	--
PB-715	110	109	100
PB-716	35	36	--
PB-799	170	168	--
PB-800	15	16	--
PB-830	1,250	1,325	1,200
PB-831	20	18	20
PB-832	70	66	--
PB-875	30	32	--
PB-876	35	34	--
PB-877	10	6	10
PB-880	320	340	320
PB-921	10,200	10,400	10,100
PB-1063	50	60	--
<u>Zone III</u>			
PB-560	90	--	--
PB-529	60	--	--
PB-662A	3,360	3,700	3,550
PB-662B	3,400	3,100	3,200
PB-838	340	145	260
PB-840	800	780	830
PB-899	4,100	4,200	4,300

Table 6.--Concentrations of major inorganic constituents and related chemical characteristics of surface water

[Concentrations shown in milligrams per liter, except for specific conductance which is in microsiemens per centimeter and color which is in platinum-cobalt units. Dissolved solids, residue at 180 degrees Celsius; --, data not available.]

Local well number	Date of collection	Calcium (Ca)	Magnesium (Mg)	Sodium (Na)	Potassium (K)	Specific conductance	Chloride (Cl)	Sulfate (SO <sub>4</sub> )	Fluoride (F)	Color	pH (units)	Bicarbonate (HCO <sub>3</sub> )	Dissolved solids	Silica (SiO <sub>2</sub> )
<u>Zone I</u>														
PB-005	5/19/83	57	5.8	31	3.3	475	59	21	0.4	60	7.5	168	305	4.9
	10/24/83	37	2.8	12	3.6	265	22	18	.3	70	7.6	99	172	3.8
	4/17/84	51	5.5	20	7.4	405	33	34	.3	80	7.2	145	250	2.6
	11/7/84	62	7.1	27	8.7	470	43	35	.4	80	7.1	170	304	3.8
PB-006	5/19/83	59	4.4	20	5.2	414	32	22	.3	60	7.6	168	256	1.3
	10/24/83	45	3.7	12	5.5	321	22	20	.4	70	7.7	136	207	3.6
	4/12/84	52	4.9	15	7.8	368	27	27	.3	80	7.2	152	233	3.0
	11/18/84	61	4.3	19	5.3	408	33	21	.3	80	7.1	170	262	2.6
PB-007	5/19/83	35	5.2	20	1.0	306	28	4.3	.3	100	7.2	124	202	3.6
	10/24/83	19	2.7	6.8	8.4	173	20	15	.4	100	6.9	46	135	2.6
	4/12/84	41	5.9	21	12	404	35	24	.4	90	7.5	123	228	3.6
	11/8/84	91	13	63	75	775	95	31	.6	140	7.5	290	516	12
PB-015	5/18/8	60	5.1	25	5.9	455	39	23	.4	60	7.8	176	284	2.3
	10/18/83	70	3.0	14	3.6	410	25	15	.3	50	7.3	210	245	5.1
	4/11/84	37	1.5	5.5	2.2	230	8	5.9	.2	70	6.4	122	141	2.1
	11/14/84	84	7.2	34	4.5	570	84	22	.3	80	7.1	250	366	7.1
PB-016	5/18/83	93	7.8	52	3.2	720	85	31	.4	100	8.0	260	461	3.6
	10/19/83	40	2.0	18	1.8	270	28	11	.3	80	7.3	112	270	3.0
	4/11/84	46	3.4	11	4.6	299	17	21	.2	100	7.5	122	197	2.4
	11/14/84	79	5.8	37	2.5	558	55	19	.4	200	7.3	220	380	6.1
PB-017	5/18/83	51	11	36	4.1	520	59	37	.4	70	7.8	156	322	7.9
	11/2/83	58	5.5	37	2.7	444	54	28	.3	80	7.5	164	329	5.8
	4/11/84	77	7.2	58	3.3	680	81	36	.2	60	7.9	239	425	6.2
	11/4/84	84	4.2	23	1.5	513	37	25	.2	40	7.2	230	314	6.3
PB-019	5/18/83	74	4.4	21	5.2	478	35	24	.4	60	7.8	209	304	2.7
	10/18/83	59	3.6	13	5.2	370	23	18	.5	50	7.7	168	254	4.9
	4/11/84	64	4.2	14	5.8	403	25	28	.3	70	7.2	179	251	4.3
	11/13/84	84	6.3	25	7.3	515	41	27	.4	80	7.2	230	340	5.3
<u>Zone II</u>														
PB-003	5/18/83	39	11	36	3.8	458	58	36	.4	70	7.4	124	288	6.8
	10/26/83	21	1.1	3.2	.4	119	4	3.0	.3	120	7.5	62	84	1.6
	4/11/84	86	3.8	21	.8	520	32	32	.2	30	7.6	248	326	7.3
	11/13/84	66	2.3	12	.7	370	18	18	.4	30	7.6	170	--	4.5
PB-004	5/19/83	130	160	1,400	1.5	8,200	2,400	350	.5	60	8.1	220	4,890	--
	10/24/83	45	2.7	11	.3	293	21	15	.3	70	8.0	132	196	--
	4/16/84	51	3.0	17	.4	355	24	16	.2	80	7.0	156	219	--
	11/7/84	65	3.0	15	.6	377	26	16	.5	80	7.3	180	248	--
PB-008	5/19/83	48	12	54	2.8	590	77	13	.4	--	--	--	358	--
	10/24/83	40	3.5	14	4.9	318	23	19	.3	70	6.9	116	190	3.9
	4/16/84	72	21	92	5.7	910	130	66	.6	140	7.4	277	590	14
	11/8/84	75	21	91	7.3	905	130	52	.9	140	7.4	270	600	15
PB-011	5/18/83	45	12	42	4.3	520	66	37	.4	60	7.7	140	328	7.3
	10/18/83	87	3.0	10	4.6	478	15	79	.4	50	7.4	184	302	6.0
	4/11/84	80	3.5	17	3.6	510	26	92	.2	20	7.3	159	305	4.5
	11/13/84	74	12	80	4.2	860	130	47	.3	45	7.9	220	--	7.5
PB-012	05/18/83	78	3.1	25	.6	498	44	14	.3	60	7.7	212	315	6.4
	10/18/83	8.9	.5	2.1	.3	66	5	.3	.3	50	6.3	24	45	.6
	4/11/84	69	4.0	26	.8	481	37	22	.2	35	8.1	208	294	6.6
	11/13/84	60	2.2	10	.6	350	16	14	.2	45	7.5	170	--	6.0
PB-013	5/18/83	35	11	34	3.9	434	55	36	.4	80	7.5	110	284	5.6
	10/13/83	110	36	190	12	1,600	270	99	.9	160	8.2	442	1,050	25
	4/19/84	96	32	150	8.1	1,300	200	92	.8	200	7.7	376	872	20
	11/13/84	54	13	41	3.8	570	75	47	--	40	7.5	150	--	11
PB-014	5/18/83	35	11	34	4.0	433	56	37	.4	80	7.5	110	274	5.6
	10/13/83	100	32	180	11	1,500	250	93	.8	160	7.4	412	976	23
	4/19/84	88	30	150	7.6	1,210	200	82	.8	160	7.6	344	808	18
	11/13/84	120	28	320	7.5	2,260	430	150	.5	80	8.0	370	1,290	13
PB-018	5/18/83	45	2.9	16	.8	316	25	8.7	.8	40	7.5	131	191	1.3
	10/25/83	22	1.5	6.1	1.0	145	11	4.0	.2	50	7.1	57	93	2.4
	4/18/84	46	3.0	16	1.2	310	29	8.0	.4	50	7.2	146	198	1.5
	11/13/84	46	3.0	21	1.0	322	27	8.0	.2	60	7.7	130	192	5.1
<u>Zone III</u>														
PB-001	5/10/83	96	37	100	6.2	1,140	150	61	.9	100	8.0	431	757	13
	10/27/83	180	60	100	7.9	1,510	180	210	1.2	160	8.1	538	1,220	31
	4/20/84	46	17	55	4.7	620	88	62	.9	40	7.1	158	404	12
	11/7/84	55	19	57	5.4	658	85	61	.4	40	7.4	178	420	11

Table 6.--Concentrations of major inorganic constituents and related chemical characteristics of surface water

Local well number	Date of collection	Calcium (Ca)	Magnesium (Mg)	Sodium (Na)	Potassium (K)	Specific conductance	Chloride (Cl)	Sulfate (SO4)	Fluoride (F)	Color	pH (units)	Bicarbonate (HCO3)	Dissolved solids	Silica (SiO2)
<u>Zone III--Continued</u>														
PB-002	5/10/83	71	27	83	5.4	945	120	31	0.7	120	7.9	345	594	18
	10/27/83	120	32	76	4.2	1,080	120	50	.9	80	7.8	448	695	16
	4/24/84	66	24	73	5.5	800	110	65	.7	60	7.7	240	518	11
	11/6/84	66	24	73	6.0	814	110	63	.7	70	7.3	240	510	13
PB-010	10/24/83	120	44	150	11	1,500	210	90	1.2	200	7.7	484	1,010	26
	4/23/84	71	22	89	4.6	1,040	120	46	.7	120	7.6	280	566	13
	11/8/84	110	32	140	8.2	1,300	200	51	1.2	140	8.2	430	818	21
PB-020	5/10/83	36	13	41	4.8	480	85	48	.2	90	7.8	130	324	10
	10/31/83	80	27	93	7.2	1,000	130	96	.7	60	7.9	264	692	32
	4/12/84	59	24	110	7.1	1,070	160	76	.8	60	7.5	244	597	28
	11/15/84	45	15	47	4.9	565	73	50	.4	40	7.9	150	362	12
PB-021	5/10/83	30	10	31	3.9	405	53	40	.2	120	7.6	120	278	7.1
	10/31/83	50	17	61	5.9	662	95	61	.7	30	7.7	151	444	16
	4/10/84	190	43	470	15	3,040	680	250	.8	200	7.9	525	2,030	24
	11/15/84	41	14	46	5.1	550	73	48	.3	40	8.0	140	316	11
PB-022	5/10/83	46	18	57	5.8	620	88	91	.8	50	7.9	171	419	11
	10/28/83	100	24	68	5.6	960	110	170	.8	100	8.0	307	661	14
	4/12/84	100	38	160	5.8	1,470	220	59	.5	100	7.5	355	939	22
	11/7/84	54	18	54	5.1	638	83	56	.5	50	7.7	170	406	11
PB-023	5/10/83	73	28	84	6.5	950	130	76	.6	70	8.0	311	607	12
	10/28/83	150	58	140	10	1,600	200	190	1.4	200	8.2	504	1,220	32
	4/12/84	140	55	140	3.8	1,650	200	220	1.0	200	7.5	492	1,170	30
	11/9/84	48	16	49	5.0	591	79	52	.5	40	7.4	160	344	11
PB-024	5/10/83	59	22	68	6.2	780	100	70	.5	60	7.9	224	502	11
	11/1/83	150	58	160	12	1,750	240	160	1.1	240	8.1	572	1,270	34
	4/12/84	150	55	120	8.9	1,500	170	170	1.3	240	7.8	524	1,120	26
	11/9/84	47	16	49	5.0	588	77	52	.4	30	7.9	160	348	11
PB-025	10/27/83	160	44	72	6.5	1,260	120	180	1.0	120	7.9	453	991	15
	4/23/84	50	18	55	4.9	620	83	58	.5	50	7.3	164	394	7.9
	11/7/84	52	19	55	5.0	638	82	58	.5	50	7.5	180	396	11
PB-026	4/23/84	49	19	56	5.0	730	93	67	.5	50	7.5	176	421	6.8
	11/6/84	77	20	59	5.2	773	92	64	.6	80	7.6	250	494	9.7

Table 7.--Chloride concentrations in samples collected during test well drilling,  
Palm Beach County, September and October 1983

[Concentrations shown in milligrams per liter; --, data not available.]

Local well number	Chloride concentrations, depth below land surface (in feet)															
	20	30	40	45	50	60	70	80	90	100	110	160	180	200	210	220
PB-1460	21	26	--	39												
PB-1461	110	130	195	200												
<sup>1</sup> PB-1462	120	--	225													
<sup>1</sup> PB-1463	180	225	255													
<sup>2</sup> PB-1464	175	280	320	620												
<sup>2</sup> PB-1465	220	760	1,200	1,600												
<sup>1</sup> PB-1466	205	205	220													
<sup>1</sup> PB-1467	500	2,850	3,050													
<sup>2</sup> PB-1468	300	460	540	780												
<sup>2</sup> PB-1469	180	190	185	190												
<sup>2</sup> PB-1470	180	320	380	380												
<sup>2</sup> PB-1471	110	135	560	880												
<sup>2</sup> PB-1472	135	165	180	660												
<sup>2</sup> PB-1473	220	350	215	400												
<sup>2</sup> PB-1474	145	155	140	135												
<sup>3</sup> PB-1475	120	125	130	--	120	120	115									
<sup>2</sup> PB-1476	100	115	120	120												
<sup>2</sup> PB-1477	85	90	--	580												
<sup>2</sup> PB-1478	90	90	--	130												
<sup>2</sup> PB-1479	180	1,550	1,750	1,800												
<sup>4</sup> PB-1480	210	440														
PB-1481	170	170	155	--	--	--	--	1,850	4,500	5,200	5,300	6,300	6,400	6,500	6,450	6,500
<sup>5</sup> PB-1482	--	2,550	--	--	4,800	--	--	5,600	5,600	--	7,000	8,900	11,000			
<sup>6</sup> PB-1483	--	190	--	--	190	--	215	220	375	480	520	3,200	4,500	4,800	4,900	5,000
<sup>7</sup> PB-1484	280	--	--	--	--	--	2,150	2,550	2,800	3,100	3,200	4,200	4,300	4,300		
<sup>6</sup> PB-1485	--	--	620	--	700	--	1,060	1,120	1,220	1,380	1,500	2,450	2,750	2,550	2,600	2,600
<sup>6</sup> PB-1486	85	--	--	--	--	115	160	540	1,060	1,540	1,850	3,000	3,000	3,000	3,100	3,200

- <sup>1</sup> Bottom of well at 40-foot depth.
- <sup>2</sup> Bottom of well at 45-foot depth.
- <sup>3</sup> Bottom of well at 70-foot depth.
- <sup>4</sup> Bottom of well at 30-foot depth.
- <sup>5</sup> Bottom of well at 180-foot depth.
- <sup>6</sup> Bottom of well at 220-foot depth.
- <sup>7</sup> Bottom of well at 200-foot depth.