



2023 SEA LEVEL RISE AND FLOOD RESILIENCY PLAN



SEPTEMBER 1, 2023



Building Resilience and Mitigating Risks
to South Florida's Water Resources

Page intentionally left blank.

Table of Contents

INTRODUCTION.....	1
Priority Projects.....	2
Stakeholder Coordination.....	2
Funding Strategies.....	3
1: RESILIENCY VISION.....	1
Introduction.....	1
Risk Reduction/ Effectiveness.....	2
Implementation Resources	2
Anticipated Future Conditions	3
Vulnerable Population and Critical Infrastructure	3
Leveraging Partnerships and Public Engagement	3
Ongoing Ecosystem Restoration Efforts	4
Innovative Green/Nature-Based Solutions	4
Offsetting new Energy Demands with Sustainable Sources.....	5
2: THE CENTRAL AND SOUTHERN FLORIDA SYSTEM AND BIG CYPRESS BASIN FLOOD CONTROL SYSTEMS.....	6
Introduction.....	6
History	6
The Need for Resiliency	6
Resiliency Mission	7
SFWMD Capital Improvement Plan.....	8
3: FLOOD PROTECTION LEVEL OF SERVICE PROGRAM	10
Summary	10
Flood Vulnerability Assessment Phase (Phase I)	10
Adaptation and Mitigation Planning Phase (Phase II)	10

Implementation Phase (Phase III).....	11
FPLOS Sea Level Rise Scenarios.....	15
Future Rainfall Projections	16
Current Flood Protection Level of Service.....	17
Future Flood Protection Level Service	19
FPLOS Next Steps	23
SFWMD Flood Impact Assessment Tool (SFWMD-FIAT)	25
4: NATURE-BASED SOLUTIONS.....	27
Integrating Nature-Based Solutions	27
Process for Assessing and Implementing Nature-Based Solutions	31
Process for Evaluating Nature-Based Solutions - Estimating Direct and Indirect Benefits	33
Performance Metrics for Nature-Based Solutions	35
Resiliency Projects with Nature-Based Solutions.....	36
5: ECOSYSTEM RESTORATION PROJECTS AND RESILIENCY	44
Ecosystem Restoration Efforts	44
Northern Estuaries and Everglades	45
Central and Western everglades	46
Southern Everglades	47
Biscayne Bay.....	49
Ecosystem Restoration Projects Benefits and Potential Carbon Sequestration	50
Monitoring Approach.....	51
6: WATER SUPPLY RESILIENCY	53
Understanding Vulnerabilities	53
Responding Resiliently.....	56
Protecting Existing Water Supply	56

Investing in Water Conservation and Alternative Water Supply Sources.....	58
Saving for a Non-Rainy Day	60
ASR: Marco Island’s ASR Wells.....	61
Reservoirs: Everglades Agricultural Area (A-2) Reservoir	61
New WMA/WCA: SJRWMD C-10 WMA.....	62
Phase 1 C-51 Reservoir Project.....	62
Town of Jupiter Groundwater Recharge System.....	62
Role of Coastal Structures in Protecting Water Supply Sources	63
Resiliency Path Forward	66
7: ENERGY EFFICIENCY AND RENEWABLE ENERGY	67
Energy Efficiency.....	67
Florida Building Code Requirements and Third-Party Programs.....	68
Renewable Solar Energy	70
Solar Incentives.....	71
Low-income:.....	71
8: CHARACTERIZING AND RANKING RESILIENCY PROJECTS	72
Introduction.....	72
Socially Disadvantaged Communities	78
Centers for Disease Control/Agency for Toxic Substances and Disease Registry Social Vulnerability Index	80
CEQ CEJST.....	83
EPA EJScreen.....	88
FEMA NRI.....	90
Expected Annual Loss (EAL):.....	90
Social Vulnerability:.....	90
Community Resilience:.....	90
Proposed Ranking Criteria	94
Criteria Set 1: Likelihood of System Deficiencies.....	95
Criteria Set 2: Consequence of System Deficiencies.....	97
Criteria Set 3: Benefits from System Enhancements.....	98
Criteria Set 4: Project Status (SIP/CIP Programs).....	99

Process for Applying Criteria	99
9: ENHANCING OUR WATER MANAGEMENT SYSTEMS: PRIORITY IMPLEMENTATION PROJECTS.....	113
SFWMD Mission and Resiliency	113
Flood Control.....	113
Water Supply Planning.....	113
Ecosystem Restoration.....	114
Resiliency Priority Implementation Projects – Cost Estimates	117
Capital Improvement Plan – Priority Projects	119
District Resiliency Priority Projects.....	121
S-28 Coastal Structure and C-8 Basin Resiliency	124
Percent of Population Impacted.....	125
Community-Wide Benefits.....	125
Impacts to Lifelines.....	125
Transportation.....	126
Safety and Security.....	126
Impacts to Disadvantaged Communities.....	126
Project Scope.....	126
Adaptation and Mitigation Study for the C-8 Basin.....	127
C-8 Basin Cost Estimate.....	131
S-29 Coastal Structure and C-9 Basin Resiliency	132
Percent of Population Impacted.....	133
Community-Wide Benefits.....	133
Impacts to Lifelines.....	133
Transportation.....	134
Safety and Security.....	134
Impacts to Disadvantaged Communities.....	134
Project Scope.....	135
Adaptation and Mitigation Study for the C-9 Basin.....	136
C-9 Basin Cost Estimate.....	140
C-9 Canal Widening and Enhancement with Nature-Based Features.....	141
S-27 Coastal Structure and C-7 Basin Resiliency	144
Percent of Population Impacted.....	144
Community-Wide Benefits.....	145
Impacts to Lifelines.....	145

Transportation.....	145
Safety and Security.....	145
Impacts to Disadvantaged Communities.....	146
Project Scope.....	146
S-27 Cost Estimate.....	152
S-26 Coastal Structure Resiliency	153
S-26 Cost Estimate.....	155
G-57 Coastal Structure Resiliency.....	156
G-57 Cost Estimate.....	157
S-22 Coastal Structure Resiliency	158
S-22 Cost Estimate.....	160
S-37A Coastal Structure Resiliency	161
S-37A Cost Estimate.....	161
G-58 Coastal Structure Resiliency.....	162
G-58 Cost Estimate.....	162
S-123 Coastal Structure Resiliency	163
S-123 Cost Estimate.....	163
S-20F Coastal Structure Resiliency.....	164
S-20F Cost Estimate.....	164
S-21 Coastal Structure Resiliency	165
S-21 Cost Estimate.....	165
S-21A Coastal Structure Resiliency	166
S-21A Cost Estimate.....	166
G-93 Coastal Structure Resiliency.....	167
G-93 Cost Estimate.....	167
S-25B Coastal Structure Resiliency	168
S-25B Cost Estimate.....	169
G56 Coastal Structure Resiliency	170
G-56 Cost Estimate.....	170
G-54 Coastal Structure Resiliency.....	171
G-54 Cost Estimate.....	171

S-25 Coastal Structure Resiliency	172
S-25 Cost Estimate.....	172
S-33 Coastal Structure Resiliency	173
S-33 Cost Estimate.....	173
S-20G Coastal Structure Resiliency	174
S-20G Cost Estimate.....	174
S-13 Coastal Structure Resiliency	175
S-13 Cost Estimate.....	175
S-36 Coastal Structure Resiliency	176
S-36 Cost Estimate.....	176
S-197 Coastal Structure Resiliency	177
S-197 Cost Estimate.....	178
S-20 Coastal Structure Resiliency	179
S-20 Cost Estimate.....	179
Remaining Water Control Structures Resiliency	180
Self-Preservation Mode at Critical Structures, Coastal Structures Enhancement, and Storm Surge Protection	184
L-8 FEB / G-539 Pump Resiliency Upgrades	189
L-8 FEB / G-539 Pump Resiliency Upgrades Cost Estimate.....	Error! Bookmark not defined.
Hardening of S-2, S-3, S-4, S-7, S-8 Engine Control Panels – Building Resiliency in Water Management South of Lake Okeechobee	190
Hardening Of S-2, S-3, S-4, S-7, S-8 Engine Control Panels – Building Resiliency in Water Management South of Lake Okeechobee Cost Estimate.....	Error! Bookmark not defined.
JW Corbett Wildlife Management Area Hydrologic Restoration and Levee Resiliency	191
Background.....	191
Corbett Wildlife Management Area.....	191
Loxahatchee River Watershed Restoration Project.....	192
Flood Protection.....	192
Bahigrass Pilot Study.....	193
Corbett WMA Hydrologic Restoration and Levee Resiliency Cost Estimate.....	193

C-29, C-29a, C-29b and C-29c canal conveyance improvement	194
C-29, C-29A, C-29B AND C-29C Canal Conveyance - Cost Estimate.....	195
S-59 Structure enhancement and C-31 canal Conveyance Improvements	196
Erosion Control at S-59 and C-31 Conveyance Improvements Cost Estimate.....	198
S-58 Structure Enhancement and Temporary Pump	199
S-58 Structure Enhancement Cost Estimate.....	201
S-61 Spillway enhancement and erosion control.....	202
S-61 Spillway Enhancement Cost Estimate	203
Corbett Levee water control structures.....	204
Corbett Water Control Structures Cost Estimate.....	205
FPLoS Assessment (Phase I Studies)	229
Big cypress basin microwave tower	206
Cost Estimate.....	206
L-31E Levee Improvements.....	207
L-31E Levee Storm Surge Study.....	207
Areas of Influence	210
L-31 Levee Cost Estimate.....	210
Directing Coastal Ecosystem Resilience Phase 2: the Everglades mangrove migration assessment (EMMA)	211
Goals and Objectives.....	211
Study Design.....	212
Sediment Elevation Table (SET).....	215
Water and Soil Analysis.....	215
EMMA Cost Estimate.....	216
Directing Coastal Ecosystem Resilience Phase 1: the Mangrove Experimental Manipulation exercise (MEME).....	217
MEME Cost Estimate.....	219
South Miami-Dade Curtain Wall	220
South Miami-Dade Curtain Wall Cost Estimate.....	224
Renewable Energy Projects	225
Solar Canopy at District Headquarters.....	225
Floating Solar Panel Pilot Project.....	225
Solar Panel Installations at C-43 and C-44.....	225

10: PRIORITY PLANNING STUDIES.....	226
Summary	226
FPLOS Adaptation and Mitigation Planning (Phase II Studies)	227
Water Supply Vulnerability Assessment	229
Water and Climate Resiliency Metrics - Web Tool Implementation	232
Hydrometeorological Data Monitoring	233
Statewide Regional Climate Projections	234
Enhancing Tidal Predictions (SFWMD, University of Miami Rosenstiel School of Marine and Atmospheric Science)	235
Flooding Observation Survey and Notification System	237
Evaluating the Performance of the SFINCS Hazard Model to Support and Accelerate the FPLOS and SEFL Regional Adaptation Planning Efforts	238
Green Infrastructure Flood Mitigation Strategies - Associating Water Quality Benefits in the Little River Watershed	240
Waterways Impact Protection Effort (Project WIPE-Out).....	241
Future Conditions District Internal resources for Regulation	243
Carbon Storage Monitoring and Reporting.....	244
Upper Kissimmee Basin Flood Study, Adaptation Planning, and Project Recommendations.....	248
Modeling.....	Error! Bookmark not defined.
Development of Mitigation and Adaptation Strategies.....	Error! Bookmark not defined.
Implement Fast-tracked Projects.....	Error! Bookmark not defined.
Implement Long Term Projects.....	Error! Bookmark not defined.
Implementation.....	Error! Bookmark not defined.
Upper Kissimmee Basin Flood Study Cost Estimate.....	249
A Surface Elevation Table Network To Monitor Accretion and Address Impacts from Climate Change	250
Introduction.....	250
Formulation.....	250
Goal and Objectives.....	251
Project Design and Methodologies.....	251
Expected Results, Applications, and Benefits.....	253

Flux Towers	253
Cost estimates.....	256
Flux Towers	256
Instrumentation.....	256
Personnel Support.....	257
Soil Accretion Monitoring.....	257
Final Comments and Next Steps	258

List of Figures

Figure 2-1: Examples of Structure Inspection Program Reports and the Overall Risk Rating Matrix.....	8
Figure 3-1: FPLoS Basin Assessment Priorities and Status of Implementation.....	13
Figure 3-2: Summary of Future Rainfall Change Factors in South Florida.....	17
Figure 3-3: Current Flood Protection Level of Service.....	18
Figure 3-4: Future Flood Protection Level of Service.....	19
Figure 3-5: FPLoS Basin Adaptation and Mitigation Planning Map.....	24
Figure 3-6: Block Diagram of SFWMD-FIAT Tool.....	26
Figure 4-1: Conceptual Plan for the C-8 Basin.....	30
Figure 4-2: Land Use Types and SFWMD Right of Way lands within the C-8 Basin in Miami-Dade County.....	33
Figure 5-1: Experimental Design for Everglades Mangrove Migration Assessment.....	49
Figure 5-2: Restored Section of the Kissimmee River.....	50
Figure 5-3: Carbon Cycle.....	51
Figure 6-1: Regional Water Supply Plan Update Schedule and Respective Planning Areas.....	54
Figure 6-4: Coastal Hydrologic Cycle.....	57
Figure 6-5: Reclaimed Water System.....	59
Figure 6-6: Aquifer Storage and Recovery.....	60
Figure 6-7: C-51 Reservoir Project.....	60
Figure 6-8: Marco Island's ASR Wellfield.....	61
Figure 6-9: Water Conservation Areas.....	62
Figure 6-10: Headwater and Tailwater Stages at S-29 Structure.....	63
Figure 6-11: Average November Positive Groundwater Depth Difference Due to Optimized Structure Operations.....	64
Figure 6-12: Saltwater Interface Line in S-27, S-28, and S-29 Structures.....	65
Figure 7-1: Lake Freddy Floating Solar Array Pilot Project.....	70
Figure 8-1: Central & Southern Florida Project.....	72
Figure 8-2: Relative Percent Gate Closure Times during the 2020 High Tide Season.....	75
Figure 8-3: Potential amount of time need to remove cumulative flows at S-27.....	76
Figure 8-7: Illustrative Adaptation Pathways map for the C-7 Basin.....	77
Figure 8-8: Potential Flood Mitigation Measures to improve resilience and sustainability.....	78

Figure 8-9: Communities identified as socially vulnerable based on the CDC/ATSDR SVI overall ranking for census tracts within the SFWMD region.....	82
Figure 8-10: Communities identified as disadvantaged based on the CEQ CEJST for the water and wastewater, climate change, workforce, and energy burden categories.....	86
Figure 8-11: Communities identified as disadvantaged based on the CEQ CEJST for the transportation, housing, pollution, and health burden categories.....	87
Figure 8-12: Relative natural hazard risk based on the FEMA NRI composite score for census tracts within the SFWMD region.....	93
Figure 8-13: Examples of Project Impact Areas from the Proposed L-31E Levee Project (left) and the Corbett Levee (right).....	101
Figure 8-14: Summary and Scoring System utilized for characterizing Criteria Set 1 “Likelihood of System Deficiency”	102
Figure 8-15: Summary and Scoring System utilized for characterizing Criteria Set 2 “Consequence of System Deficiency”	102
Figure 8-16: Summary and Scoring System utilized for characterizing Criteria Set 3 “Benefits from System Enhancement”	103
Figure 8-17: Summary and Scoring System utilized for characterizing Criteria Set 4 “Project Status (SIP/CIP Programs)”.....	103
Figure 8-18: Critical Assets (Lifelines) per Coastal Structures Resiliency Project Impact Areas, utilized as part of the Resiliency Projects Ranking Criteria Set 2.....	105
Figure 8-19: Critical Assets (Lifelines) per Other Priority Project Impact Areas, utilized as part of the Resiliency Projects Ranking Criteria Set 2.....	106
Figure 8-20: Regional Significant Assets per Coastal Structures Resiliency Project Impact Areas, utilized as part of the Resiliency Projects Ranking Criteria Set 2.....	107
Figure 8-21: Regional Significant Assets per Other Project Impact Areas, utilized as part of the Resiliency Projects Ranking Criteria Set 2.....	108
Figure 8-22: Public Water Supply Wellfields per Coastal Structures Resiliency Project Impact Areas, utilized as part of the Resiliency Projects Ranking Criteria Set 2.....	109
Figure 8-23: Public Water Supply Wellfields per Other Project Impact Areas utilized as part of the Resiliency Projects Ranking Criteria Set 2.....	110
Figure 8-24: Total Population per Coastal Structures Resiliency Project Impact Areas, utilized as part of the Resiliency Projects Ranking Criteria Set 2.....	111
Figure 8-25: Total Population per Other Project Impact Areas utilized as part of the Resiliency Projects Ranking Criteria Set 2.....	112
Figure 9-1: Conceptual Resiliency Maturity by Mission Area.....	115

Figure 9-2: Diagram describing how projects are formulated and entered into this plan.....	116
Figure 9-3: S-28 Impacts of Sea Level Rise Projections.....	124
Figure 9-4: Site plan for S-28 Structure features and conceptual plan for the C-8 Basin.....	130
Figure 9-5: Map of C-9 Basin.....	132
Figure 9-6: Reduction in conveyance capacity at S-29 as SLR continues.....	132
Figure 9-7: Pickwick Lake wetland restoration/stormwater detention area features.....	137
Figure 9-8: Site plan at S-29 Structure.....	139
Figure 9-9: Potential project footprint for C-9 Enhancement project.....	142
Figure 9-10: Typical canal cross-section before and after widening.....	142
Figure 9-11: Typical section of the C-9 Canal Enhancement project showing potential project features.....	143
Figure 9-12: Typical cross-section of the C-9 Canal Enhancement project showing potential project features.....	143
Figure 9-13: Map of C-7 Basin.....	144
Figure 9-14: Site plan at S-27 Structure.....	147
Figure 9-15: Nature-based features at W.H. Turner High School.....	149
Figure 9-16: Typical living shoreline detail and stormwater detention area/wetland restoration area.....	151
Figure 9-17: Land Needs for S-26 Structure Enhancements.....	154
Figure 9-18: Real Estate Needs for S-25.....	169
Figure 9-19: Potential Impacts of Rising Sea Levels.....	180
Figure 9-20: Lake Hart Water Stages.....	195
Figure 9-21: East Lake Toho Water Stages.....	197
Figure 9-22: Lake Alligator Water Stage.....	200
Figure 9-23: 100-Year Profile for Levee Crest Elevation Consideration.....	209
Figure 9-24: Location of L31E Levee (yellow) and area of influence (red).....	210
Figure 9-25: EMMA Assessment Locations (From left to right: Charly Site and Pocket Site).....	213
Figure 9-26: Pocket Site study design.....	213
Figure 9-27: Pocket Site study design.....	214
Figure 9-28: Study plot locations.....	217
Figure 9-29: MEME and MEME Study Design.....	218
Figure 9-30: Location and extension of three curtain wall configuration scenarios (2018).....	222
Figure 9-31: H&H modeling results illustrating the average water stage difference with and without the full extent curtain wall scenario.....	223

Figure 10-1: SET Installation.....	253
Figure 10-2: Everglades eddy covariance tower sites.....	255

List of Tables

Table 3-1: Sea Level Rise Projections.....	16
Table 3-2: Flood Protection Level of Service Summary Assessment for Maximum Stage in Primary Canals.....	20
Table 3-3: Frequency of Flooding (PM5) for current and future conditions.....	21
Table 4-1: Nature-Based Solutions/Green Infrastructure.....	31
Table 4-2: Examples of Assessment Methodologies for Flood Control Projects.....	34
Table 4-3: Potential Performance Metrics.....	36
Table 8-1: CDC/ATSDR SVI Themes and Corresponding Social Factors.....	81
Table 8-2: The CEQ CEJST categories and corresponding factors.....	85
Table 8-3: EPA EJScreen and supplemental indexes and corresponding indicators.....	89
Table 8-4: FEMA NRI components.....	92
Table 8-5: Ranking of Coastal Structure Projects (top) and Priority Projects (bottom).....	104
Table 9-1: Summary of Cost Assumptions.....	118
Table 9-2: List of CIP priority projects.....	119
Table 9-3: List of Resiliency Priority Projects showing how the project is linked to the District’s mission as well as implementation and funding status.....	121
Table 9-4: FPLOS Phase II project component recommendations for the C-8 Basin.....	128
Table 9-5: FPLOS Phase II project component recommendations for the C-9 Basin.....	136
Table 9-6: Remaining Coastal Structures and Placeholder Costs.....	182
Table 9-7: Modifications and costs needed to harden coastal structures.....	188
Table 9-8: Average Annual Overland Flows to Shark River Slough during wet and dry seasons for three curtain wall scenarios compared to the no-wall scenario.....	223
Table 10-1: Covariance Towers, principle investigators, permit and network association.....	256
Table 10-2: Major instrumentation for the eddy covariance method.....	256
Table 10-3: Total annual budget for the Greater Everglades Carbon Project.....	257

Project Team

Carolina Maran	District Resiliency	Ryan Brown	Vegetation Management
David Colangelo	District Resiliency	LeRoy Rodgers	Vegetation Management
Francisco Pena	District Resiliency	Fred Sklar	Applied Sciences
Nicole Cortez	District Resiliency	Cassandra Armstrong	Applied Sciences
Zan Kugler	District Resiliency	Phyllis Klarmann	Applied Sciences
Candida Heater	Budget and Finance	Matthew Biondolillo	Ecosystem Restoration
Julie Maytok	Budget	Maryam Mashayekhi	GeoSpatial Services
Lucine Dadrian	Engineering & Construction	Christine Carlson	GeoSpatial Services
Vijay Mishra	Engineering & Construction	Alexandra Hoffart	GeoSpatial Services
Sandy Smith	Engineering & Construction	Mark Elsner	Water Supply
Akintunde Owosina	Hydrology and Hydraulics	Peter Kwiatkowski	Water Supply
Hongying Zhao	Hydrology and Hydraulics	Jim Harmon	Water Supply
Matahel Ansar	Hydrology and Hydraulics	Tom Colios	Water Supply
Tibebe Dessalegne	Hydrology and Hydraulics	Bradley Jackson	Big Cypress Basin
Jun Han	Hydrology and Hydraulics	Marcy Zehnder	Real Estate

Executive Summary

Introduction

The South Florida Water Management District (District or SFWMD) is strongly committed to continuing to address the impacts of land development, population growth, and climate change on water resources. Climate change impacts include sea level rise, changing rainfall patterns, and evapotranspiration trends. As a regional government agency, the District manages water resources in the southern half of Florida, covering 16 counties from Orlando to the Florida Keys and serving a population of nine million residents. The District is dedicated to working with local, state, and federal partners to ensure the District provides the best available science-backed data to inform decision-making throughout South Florida. As a key part of the resiliency strategy, the District evaluates the status of its flood control infrastructure, water supply operations, and ongoing ecosystem restoration efforts and advances projects necessary to continue providing flood control, water supply, and ecosystem restoration in anticipation of future climate conditions. In coordination with the Florida Department of Environmental Protection, the Florida Department of Emergency Management, other State and Federal agencies, and local governments, the District is making infrastructure adaptation investments needed to implement its mission successfully.

This SFWMD Sea Level and Flood Resiliency Plan, which is updated annually, is the first District initiative to compile a comprehensive list of priority resiliency projects to reduce the risks of flooding, sea level rise, and other climate impacts on water resources and increasing community and ecosystem resiliency in South Florida. This goal will be achieved by updating and enhancing water management infrastructure throughout the Central & South Florida (C&SF) Flood Control System and the Big Cypress Basin and implementing effective, resilient, sustainable, integrated basin-wide solutions. This list of projects was compiled based on vulnerability assessments that have been ongoing for the past decade. These assessments utilize extensive data observations and robust technical hydrologic and hydraulic model simulations to characterize current and future conditions and associated risks.

The District's Flood Protection Level of Service (FPLOS) Program has been advancing integrated modeling efforts in critical basins to aid in understanding flood vulnerabilities within the C&SF System and identifying cost-effective implementation strategies to ensure that each basin can maintain its designated flood protection level of service under current and projected conditions. In addition, the District's Capital Improvement Plan (CIP) has been incorporating climate change and sea level rise considerations into the design of critical infrastructure projects. The FPLOS and CIP Programs have successfully identified critical resiliency investments now being organized and expanded in this document.

Priority Projects

The list of priority resiliency projects includes investments needed to increase the resiliency of the C&SF System and Big Cypress Basin flood control infrastructure. These projects represent urgent actions necessary to address the vulnerability of the existing infrastructure, including structure enhancement recommendations and other adaptations needed to address sea level rise. Project recommendations also comprise basin-wide flood adaptation strategies that are based on other FPLOS recommendations and water supply and water resources of the State protection efforts. These projects include adding a “self-preservation mode” function to water control structures, enhancing the C-9 canal, construction of the South Miami-Dade Curtain Wall, L31E Levee improvements, and the JW Corbett Wildlife Management Area Hydrologic Restoration and Levee Resiliency project. Each of these projects helps to increase the functionality and capacity of the District’s flood control and water supply systems and protection of the environment. The Everglades Mangrove Migration Assessment Pilot Study is being proposed to capture the adaptive foundational resilience of the coastal wetlands within the District and to demonstrate the ability of coastal wetlands to adapt to rising sea levels via enhanced soil elevation change. Additionally, renewable energy projects are proposed in this plan to help offset new and existing energy requirements. Finally, critical planning projects are presented to continue to develop our resiliency efforts. These include vulnerability assessments and scientific data and research that will ensure the District’s resiliency planning and projects are founded on the best available science.

This plan includes an updated multicriteria ranking approach developed to assess vulnerable areas in South Florida. This ranking approach includes metrics to identify the critical infrastructure and vulnerable areas while considering basin-wide resiliency needs. Cost estimates for each proposed project are presented, as well as recommendations to incorporate sustainable energy sources and utilize the most efficient designs, using both traditional gray infrastructure improvements and nature-based solutions. This plan has been updated in 2023 to include additional resiliency project priorities, strategies for nature-based solutions, new sustainable energy options, more details about ongoing ecosystem restoration efforts and associated potential carbon storage, and the latest approach being proposed for the development of the water supply vulnerability assessment.

Stakeholder Coordination

The District seeks to implement projects that benefit South Florida’s communities and environment by working closely with state, tribal, private, and local governments and considering the needs of socially vulnerable communities and protected environmental areas. In its third iteration, this plan document includes significant contributions from our stakeholders, after meticulous consideration and incorporation of comments submitted by more than 20 partners agencies each year. In December 2022, the District

began hosting quarterly South Florida Resiliency Coordination Forum meetings to promote further collaboration with local, state, federal and tribal partners on water management initiatives related to resiliency; receive input on our projects and to engage partners in assessing the impacts of changing climate conditions and water management implications. Meeting agendas and recordings can be found on the District's Resiliency Coordination Forum web page (1).

Funding Strategies

The District continues to seek funding alternatives at the State and Federal levels to help fund the implementation of project recommendations included in this plan.

At the State level, in May 2021, Governor Ron DeSantis signed Florida Senate Bill 1954, which created the Resilient Florida Program, providing significant funding to support flooding and sea level rise resiliency projects throughout the State. In May 2022, Governor DeSantis approved House Bill 7053, establishing further efforts toward Statewide Flooding and Sea Level Rise Resilience. In January 2023, Governor DeSantis signed Executive Order 23-06 to direct funding and strategic action to continue to support the Resilient Florida Program.

As part of the Resilient Florida Program, the District is currently working with the Florida Department of Environmental Protection to finalize grant agreements for the following projects:

- Coastal Structures Enhancement and Self-Preservation Mode
- Hardening and enhancement of S-2, S-3, S-4, S-7, S-8 Engine Control Panels
- L8 Flow Equalization Basin / G-539 Pump Resiliency Upgrade
- Corbett Levee Resiliency, in partnership with Palm Beach County

At the Federal level, the District and the U.S. Army Corps of Engineers are partnering to develop the C&SF Flood Resiliency Study to recommend adaptation strategies in the communities served by the C&SF Systems. In addition, Federal Emergency Management Agency (FEMA) mitigation and adaptation funding is under consideration, and the District is working to execute grant agreements for the award recommendations received from the FEMA Building Resilient Infrastructure and Communities Program for the following projects:

- C-7 Basin Resiliency
- C-8 Basin Resiliency
- C-8 Basin Resiliency

1: Resiliency Vision

Introduction

As with all government agencies that construct, operate, and maintain public infrastructure, the South Florida Water Management District (SFWMD or District) is faced with the predicament of change. The urbanization of South Florida, changing environmental conditions, and extreme weather greatly impact the condition and long-term performance of the District's infrastructure. To address these challenges, the District's resiliency plan sets forth the following goals for the District's water management systems:

Resiliency is the capacity for natural and man-made systems to cope with and adapt to acute and chronic stressors as climate conditions evolve.

1. The natural and man-made systems should be able to withstand or quickly recover from severe weather events without significant damage or loss of function.
2. The natural and man-made systems should be able to adapt to changing conditions and continue to provide functions adequately.



The District is committed to reducing the risks of flooding, sea level rise, and other climate impacts on water resources. The efforts include assessing how these risks and other evolving conditions happen today and, in the future, and how they affect water resources management. The District is making significant infrastructure adaptation investments that are needed to successfully implement its mission. The District is increasing community and ecosystem resiliency in South Florida by enhancing the Central and South Florida Project (C&SF Project) and Big Cypress Basin infrastructure. The District's strategy uses traditional gray infrastructure improvements and nature-based solutions. The current plan focuses on the most vulnerable infrastructure, recognizing that the District's entire area of operations will be covered as technical assessments and planning efforts identify additional resiliency projects and priorities each year. The District's resiliency vision is to reduce risk by implementing effective, resilient solutions and anticipating future conditions. The District's strategy includes public engagement through various outreach activities.

Currently, the District's Flood Protection Level of Service (FPLOS) and Capital Improvement Program (CIP) programs ensure that projects are assessed, designed, managed, and constructed using innovative techniques, incorporating sustainable sources of energy, and utilizing the most efficient designs available, with consideration of both upstream and downstream systems. Moreover, the District is developing additional vulnerability and adaptation studies. One example is the Water Supply Vulnerability Assessment, which will provide a more comprehensive overview of resiliency needs and priorities and support identifying sub-regional goals within the 16-county region served by the District.

The proposed resiliency projects follow all state and federal threatened and endangered species regulations and seek to restore and preserve wildlife habitats by integrating nature-based solutions. The District seeks to implement projects that benefit South Florida's communities and environment. The District works closely with state, tribal, private, and local governments and other agencies to assess and consider the needs of socially vulnerable communities and protected environmental areas.

The District's Resiliency Plan is a high-level planning document and is not intended to contain all the technical details and design specifications for each proposed project. As projects are moved into implementation, detailed plans, design specifications, and technical reviews will follow. Below are descriptions of each of the criteria that, when taken together, illustrate the District's resiliency vision and unique role in addressing environmental, water supply, and flood protection in the context of water management operations and infrastructure risks and vulnerabilities.

Risk Reduction/ Effectiveness

The District seeks to reduce risk while maximizing the effectiveness of projects by advancing robust hydrologic and hydraulic integrated basin-wide models through the FPLOS Program. This strategy allows the District to scrutinize maximum stages, bank exceedances, and discharge capacity of canals as well as the flood depths and durations of flood inundation. Additionally, coastal structure capacity and peak stages resulting from different storm surges and sea level rise scenarios are examined.

Implementation Resources

Implementation resources include the recognition that project planning and management are crucial steps in implementing resiliency projects. The District utilize various tools to support how project costs and schedules will be managed, how the project will be implemented, and how innovative techniques will be incorporated. A well-planned resiliency project includes the identification of technical and project management staff and other resources needed for successful implementation. Consideration is also given to potential technical, political, and financial challenges and how they can be overcome. Additionally, project costs and schedules and pre- and post-implementation monitoring plans should be well defined.

Anticipated Future Conditions

Determining future conditions is required to identify vulnerabilities, determine adaptation solutions, and evaluate their feasibility. It is vital to know when and where the population within a basin is projected to increase and if land use and development are predicted to shift. Understanding demographics and changes in the economic status of the community is also essential. Beyond the traditional planning tools, there is a need to address future climate conditions and their impacts. Potential impacts include the following:

- sea level rise
- increased intensity of extreme rainfall events
- increase in stormwater runoff volumes
- increasing groundwater elevations
- other related variables

Each resiliency project should be responsive to anticipated changes. The strategy considers the potential for change and incorporates resiliency concepts in the projects' planning, design, and future operation. Each potential project will be informed by and connected to existing planning efforts such as Hazard Mitigation Plans, Climate Adaptation Plans, and Comprehensive Plans.

Vulnerable Population and Critical Infrastructure

Equitable resiliency projects should identify the populations that will be impacted and develop solutions that have community-wide benefits and no unmitigated negative changes. Percentage of the population that will directly benefit from the project, including the extent of the project's direct and indirect protection of community lifelines (fundamental services that allow society to function), regionally significant assets, businesses, residents, public services, and natural resources, are defined. Disadvantaged communities are also identified (see Chapter 8) and taken into consideration, and benefits for these communities are maximized. The District strives to meet these criteria.

Leveraging Partnerships and Public Engagement

The District has been engaging partner agencies and the public through the organization of a series of Public Workshops and participation in relevant public events and discussions. In December 2022, SFWMD hosted the first South Florida Resiliency Coordination Forum. These recurring quarterly meetings constitute a fact-finding forum to promote collaboration with local, state, federal and tribal partners on water management initiatives related to resiliency; and engage partners in assessing the impacts of changing climate conditions and water management implications. The Forum promotes regional coordination and partnership opportunities by holding proactive discussions, leveraging technical knowledge, and exchanging information. These meetings are designed to foster a constructive

environment to discuss tangible asset-level solutions and support decision-making on water resource management.

Outreach activities are an important way to engage, learn and gain public support for resiliency projects and leverage partnerships with federal, state, tribal, private, and local governments and agencies. In addition, FPLOS public workshops, prioritized for basins with elevated flood risk where adaptation strategies and mitigation projects need to be collaboratively developed and implemented, give stakeholders with flood control responsibilities an opportunity to provide input and help guide the selection of projects compatible with local efforts/initiatives. Information and feedback from the public can add value to the District's planning process by introducing a real-world perspective to modeling results. The District is advancing integration and climate resilience strategies in the region through coordination with the public, educational institutions, local, state, and federal government agencies, including the U.S Army Corps of Engineers (USACE), Florida Department of Environmental Protection Office of Resilience and Coastal Protection, Florida Department of Emergency Management, Florida Department of Transportation, 298 Districts, planning councils, local governments, the Southeast Florida Regional Climate Change Compact, the Southwest Florida Regional Resiliency Compact, and the East Central Florida Regional Resilience Collaborative.

Ongoing Ecosystem Restoration Efforts

The District is working with USACE and other state and federal partners to ensure ongoing ecosystem restoration efforts and mainly that the Comprehensive Everglades Restoration Plan (CERP) projects are fully implemented and operational. Restoring and preserving ecosystems is key to building and maintaining resiliency throughout South Florida. These restoration-resiliency efforts have been creating and improving ecosystems, increasing ecosystem health and function, and allowing for increased water management flexibility to reduce saltwater intrusion in coastal groundwater. With improved ecosystem function, these projects have decreased the impact of flooding and sea level rise on South Florida's communities.

Innovative Green/Nature-Based Solutions

The District is committed to seeking "green" or nature-based solutions in addition to "gray" stormwater infrastructure improvements to increase resiliency. Nature-based solutions include features such as living shorelines, wetlands, artificial reefs, other urban green infrastructure features, and preservation and restoration of existing natural features. Both gray and green features will be necessary to meet the challenges of climate change impacts, including sea level rise, along with basin-wide solutions to maximize the capacity of flood adaptation and to achieve water quality benefits. District projects will also

incorporate sustainable and clean sources of energy whenever possible and utilize the most efficient designs available.

Offsetting new Energy Demands with Sustainable Sources

The District is dedicated to improving the energy efficiency of its operations and offsetting new energy demands through renewable energy solutions. By following the latest local, state, and federal building codes and using state-of-the-art materials and designs, the District builds efficient and resilient projects (Flood Resistant Design and Construction, ASCE Standard 24). As an initial step towards the goal of offsetting new energy demands, staff are assessing opportunities for implementing solar power projects as part of a variety of current projects under development.

2: The Central and Southern Florida System and Big Cypress Basin Flood Control Systems

Introduction

The purpose of this chapter is to describe the primary flood control systems that the District operates and point out current challenges due to population growth, increased land development, and changing climate impacts, including extreme rainfall events and sea level rise. A secondary purpose is to introduce the SFWMD Capital Improvement Plan (CIP) and describe how the resiliency initiatives are being integrated into the CIP and overall operations and maintenance priorities.

History

The history of water management in South Florida was driven by major flood and drought impacts and associated investments in water management infrastructure occurring after the hurricanes in the late 1920s, droughts in the 1930s, and hurricanes again in 1947. The Central and Southern Florida Project (C&SF) was initially authorized by the Flood Control Act of 1948 and subsequent Acts. It is a large, multipurpose water resources project designed and constructed by the United States Army Corps of Engineers (USACE) in partnership with what is now the South Florida Water Management (SFWMD or District), the Project's local sponsor. It was authorized for flood protection for urban and agricultural areas; prevention of saltwater intrusion risks to coastal water supply sources; water level control and conservation to ensure water supply for agricultural, municipal, industrial, and ecosystem uses; and preservation of fish and wildlife. The Project was designed to serve a population of 2 million people.

Multiple project phases throughout the years contributed to the development and expansion of the C&SF integrated water management system. Today, the key structural infrastructure of the regional (primary) C&SF system includes approximately 2,175 miles of canals, 2,130 miles of levees/berms, 89 pump stations, and 915 water control structures. The regional system connects to local (secondary) and thousands of neighborhood (tertiary) drainage systems. It is one of the world's largest and most complex water management systems and currently serves approximately 9 million residents.

The Need for Resiliency

The C&SF system is facing significant changes that are challenging the performance of the system. The main drivers of change can be largely grouped into population growth, increased development of land, extreme rainfall events, and sea level rise trends. A roughly tenfold increase in the study area population and a consequent change in land use over time, compounded by the intensity and volume of extreme

rainfall events and an average of 6 inches of observed sea level rise, has significantly changed the operational capacity of the C&SF system.

Despite significant infrastructure investments throughout the years, critical components of the C&SF system are showing deficiencies in performance. For example, gravity-operated coastal structures convey excess runoff from each respective watershed to the ocean to reduce flood risk and act as salinity intrusion barriers. Currently, many of these low-lying coastal structures have a significant reduction in discharge capacity during high tide periods and/or storm surge events because of insufficient upstream headwater (spillway) elevations. Gate overtopping due to high tailwater events has already been documented in the lower east coast region. As part of future conditions assessments, coastal structure operations were simulated under different sea level rise scenarios, considering upstream canal overbank risks and reduction in gravity discharge capacity. Based on these advanced modeled outcomes, several of these coastal structures were characterized as highly vulnerable to sea level rise, reaching bank-full elevation under a 25-year or less surge condition and with 0.5 feet or less of sea level increase.

Also, within SFWMD boundaries, the Big Cypress Basin contains a network of 143.6 miles of primary canals, 35 water control structures, and three back pumps providing flood control during the wet season and protecting regional water supplies and environmental resources from over-drainage during the dry season. The basin, facing similar conditions as described above, includes Collier County and part of Monroe County.

Resiliency Mission

Despite these challenges and opportunities, SFWMD is making infrastructure maintenance and adaptation investments needed to successfully implement its mission of safeguarding and restoring South Florida's water resources and ecosystems, protecting communities from flooding, and ensuring an adequate water supply for all South Florida's needs. The District's Capital Improvement Plan (CIP) is integrated into the process of building resilient projects that mitigate risks to South Florida's water resources. This is accomplished by enhancing the C&SF and Big Cypress Basin water control systems.

The District's CIP investments go beyond addressing maintenance, repair, rehabilitation, or replacement needs identified in inspection reports. The District is also enhancing the existing water management system with new components and operational capacity. The updates allow the aging system to operate successfully today and ensure the District's mission is accomplished. This plan document outlines the additional infrastructure investments that will be bundled with the District's CIP. The additional investments help to ensure that the District constructs resilient projects to mitigate the risks to South Florida's water resources.

SFWMD Capital Improvement Plan

Since its creation in 1949, the District has been responsible for managing the C&SF System and Big Cypress Basin. The District has a multimillion-dollar Capital Improvement Plan already in place, with an average annual budget of \$53M. All water control structures are inspected every five to seven years as part of the District’s Structure Inspection Program (SIP). The purpose of the District’s inspection program is to ensure that each facility's equipment and instrumentation can be operated safely and reliably and to prioritize infrastructure investments for the District’s CIP Program. The District commits to setting aside resources each year to implement the CIP for repairing, refurbishing, enhancing, and upgrading pump stations, canals, water control structures, levees, and water storage areas to ensure the District water management infrastructure and facilities are operating effectively and efficiently.

Inspections cover civil, structural, mechanical, electrical, and underwater components of the structure, and each component is rated based on the severity of deficiencies and on the urgency of recommended corrective actions. The individual component ratings are evaluated together to formulate an overall rating that guides the prioritization of corrective actions. Figure 2-1 illustrates examples of the structure inspection program reports and the risk matrix used to calculate the overall rating. The “likelihood of

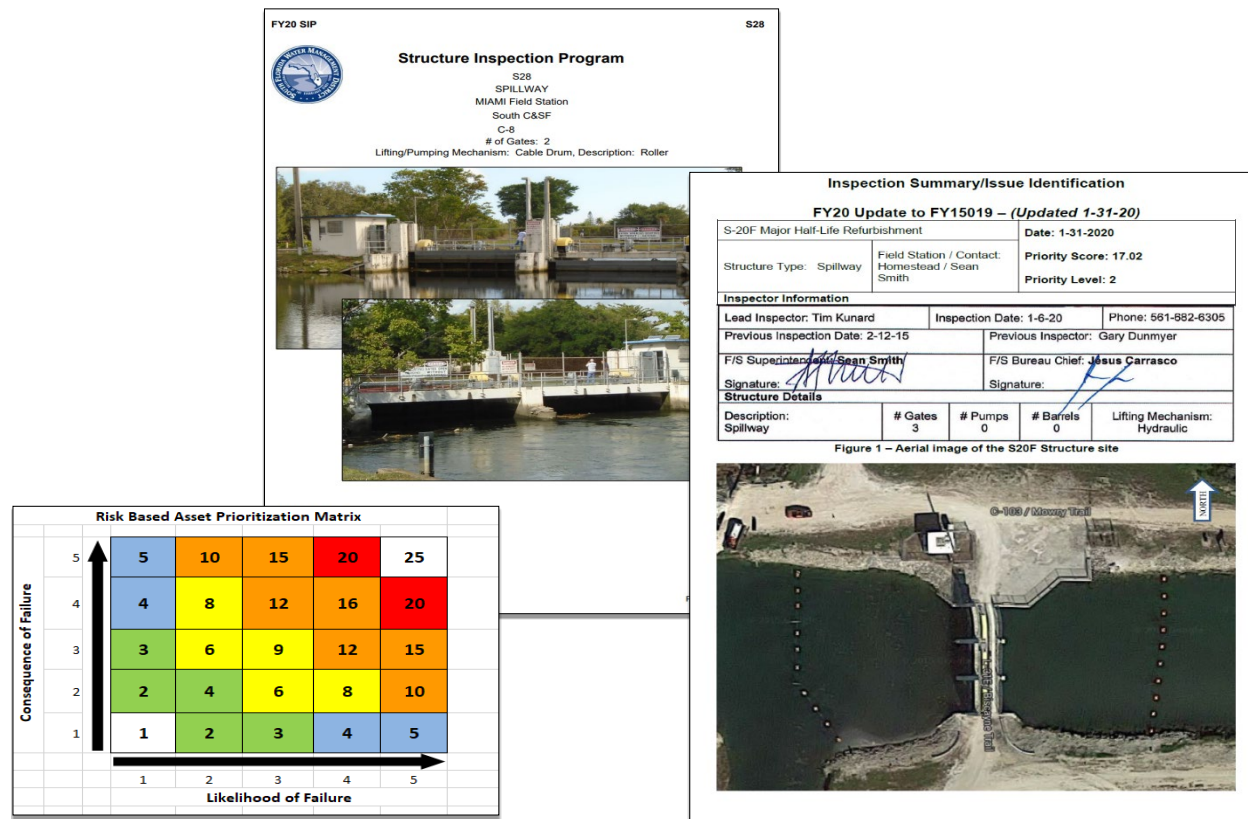

Figure 2-1: Examples of Structure Inspection Program Reports and the Overall Risk Rating Matrix

failure” scoring is calculated based on the inspection of physical condition, the ability to operate and maintain the structure/facility as intended, and the frequency of operation. The “consequences of failure” scoring is based on the location and size of the structure/facility, accounting for public health, safety, security & services, its financial impact on surrounding land use, upstream/downstream impacts, and its back up operational options. The inspection reports are also used to help evaluate adaptation strategies as part of the Flood Protection Level of Service Program. Structures that receive a critical rating for corrective actions are included as part of future conditions assessments, and modifications for sea level rise and climate change impacts are recommended, in addition to addressing conditions identified in the inspection reports. This process ensures that the Resiliency Program and the regular CIP processes are integrated, and improvements at each structure are coordinated. The goal is to not have to revisit the same structure within a short period of time. Therefore, the CIP Program informs overall resiliency planning efforts, including the Flood Protection Level of Service Program (FPLOS), which is covered in Chapter 3.

3: Assessing Flood Vulnerabilities: Flood Protection Level of Service Program

Summary

Initiated in 2015, the South Florida Water Management District's (District or SFWMD) Flood Protection Level of Service Program (FPLOS) allows the agency to evaluate the effectiveness of its flood control assets, including canals, structures, and pump stations, to determine their ability to meet and continue to meet the flood protection needs of the region. The Central and Southern Florida Project (C&SF Project) and other basins flood protection systems have many assets that are approaching the end of design life, making it critical to implement this program to inform decisions on the flood control infrastructure needs of the region. The District is implementing the FPLOS program at a regional and local scale. The program includes a methodology that helps to prioritize basins to study and a suite of tools for evaluating structures and canals in selected basins, as well as a framework for establishing the level of service. The program incorporates input from meetings and workshops with local planning and stormwater management efforts, stakeholders, and resource managers. The FPLOS will be implemented in a phased approach on an 8- to 10-year cycle. Each basin will be evaluated, and actions taken as necessary to ensure that the level of service is maintained. When remediation is needed, the lowest cost measures will be undertaken first, building to full replacement only when necessary. The cycle will provide opportunities to update land development and sea-level information and incorporate new technology and tools. This cyclic approach is the best use of funding and ensures that incremental, near-term measures will be incorporated into any long-term solution. The program is being executed in three stages.

Flood Vulnerability Assessment Phase (Phase I)

This stage of the program involves a periodic exploratory investigation of the primary system and related work and studies necessary to identify choke points or deficiencies in the flood control infrastructure with a focus on the primary system. This process is used to identify flood vulnerabilities basin-wide, represented by simulated overland flow inundation. These studies continue in perpetuity, and each basin is revisited once every eight to ten years unless significant changes in the flood control system necessitate a more frequent reassessment.

Adaptation and Mitigation Planning Phase (Phase II)

When deficiencies are identified in the system (either current or projected based on factors such as sea level rise and future rainfall), an Adaptation and Mitigation Planning study is triggered, which executes a search for a solution within the primary system as well as the secondary and tertiary systems. These public planning projects represent collaborative efforts with operators of the secondary and tertiary

systems and identify cost-effective courses of action that will when implemented, bring the flood control system back to design specifications or desired performance for the long term.

Implementation Phase (Phase III)

The final phase includes the integration of the recommended projects into this plan document and prioritization for follow-up design, permitting, real estate acquisition, and construction activities necessary to implement the selected adaptation strategy and course of action.

The District has taken a comprehensive and high-level approach to addressing the flood protection needs of the region. It is rigorous in its analyses, using high-quality integrated modeling tools, and pragmatic in its implementation. At its core, this approach is a commitment to an ongoing assessment of the state of the system to ensure that problems are identified before they occur, providing an opportunity to plan and implement adaptations and mitigation strategies before critical conditions materialize.

With a goal to reassess every basin within the District at least once every 8 to 10 years, the program initiates two Phase I assessment studies every year, starting with the most at-risk basins. This is determined based on a sea level rise vulnerability assessment, observed flooding, and known system limitations. These studies answer the key question: are the flood protection assets working, and will they continue to work for the next 50 years? Another strength of this method is the collaborative approach in search of the appropriate solution. The District engages partners and stakeholders with responsibility for the secondary and tertiary flood control systems to identify the best course of action to mitigate identified deficiencies.

Phase II of the FPLOS program includes the assessment of projects to be implemented by SFWMD, along with projects and actions to be included by stakeholders in their implementation vehicles, such as Local Mitigation Strategies and local capital projects programs. Working with and incorporating projects planned in the secondary and tertiary system will ensure robust, regionally compatible suites of projects with broad regional support and more attractive funding to ensure effective flood control. In addition to evaluating, prioritizing, and sequencing potential solutions, the FPLOS approach addresses uncertainties related to sea level rise and other climate projections by introducing decision support and facilitation tools and techniques used for decision-making under uncertainty. These tools allow decision-makers to make informed near-term decisions with the best available information that do not inhibit the implementation of further adaptation strategies should longer-term projections change from what is currently anticipated. The solutions are comprehensive and could range from a change in operations requiring no additional infrastructure to major investments in infrastructure, including using nature-based solutions whenever possible. The cycle will provide opportunities to update land development and sea-level information and

incorporate new technology and tools to ensure that incremental, near-term measures will be incorporated into long-term solutions.

Figure 3-1 illustrates the latest status of the FPLOS vulnerability assessments (Phase I) and the priority basins with existing infrastructure managed by the District.

To date, the following Phase I – Vulnerability Assessments have been completed, and the final reports are available via the link provided:

- [FPLOS Phase I C-4](#)
- [FPLOS Phase I C7, C8, and C9](#)
- [FPLOS Phase I Big Cypress Basin](#)
- [FPLOS Phase I C8 C9 Final Report and Appendices](#)
- [FPLOS Phase I Broward](#)
- [FPLOS Phase I C1, C100, C102, and C103](#)
- [C-2, C-3W, C-5 and C-6 Basins](#)
- [C-111, Model Lands, and L-31NS Basins](#)

Over the next year and a half, Phase I – Vulnerability Assessments will also be completed for the following critical basins:

- Eastern Palm Beach County, and
- Upper Kissimmee Basin.

To date, the following Phase II - Adaptation Planning Studies have been completed:

- [C-8 and C-9 Basins](#)

Over the next year and half, the following, Phase II -Adaptation Planning Studies will be completed for the following critical basins:

- C-7 Basin

Other supporting FPLOS studies, such as the Low-Lying Tidal Structure Assessment, Biscayne Bay Surge Model, and the Atlas Updates for all the FPLOS basins, also contribute to further understanding of flood vulnerabilities across the District.

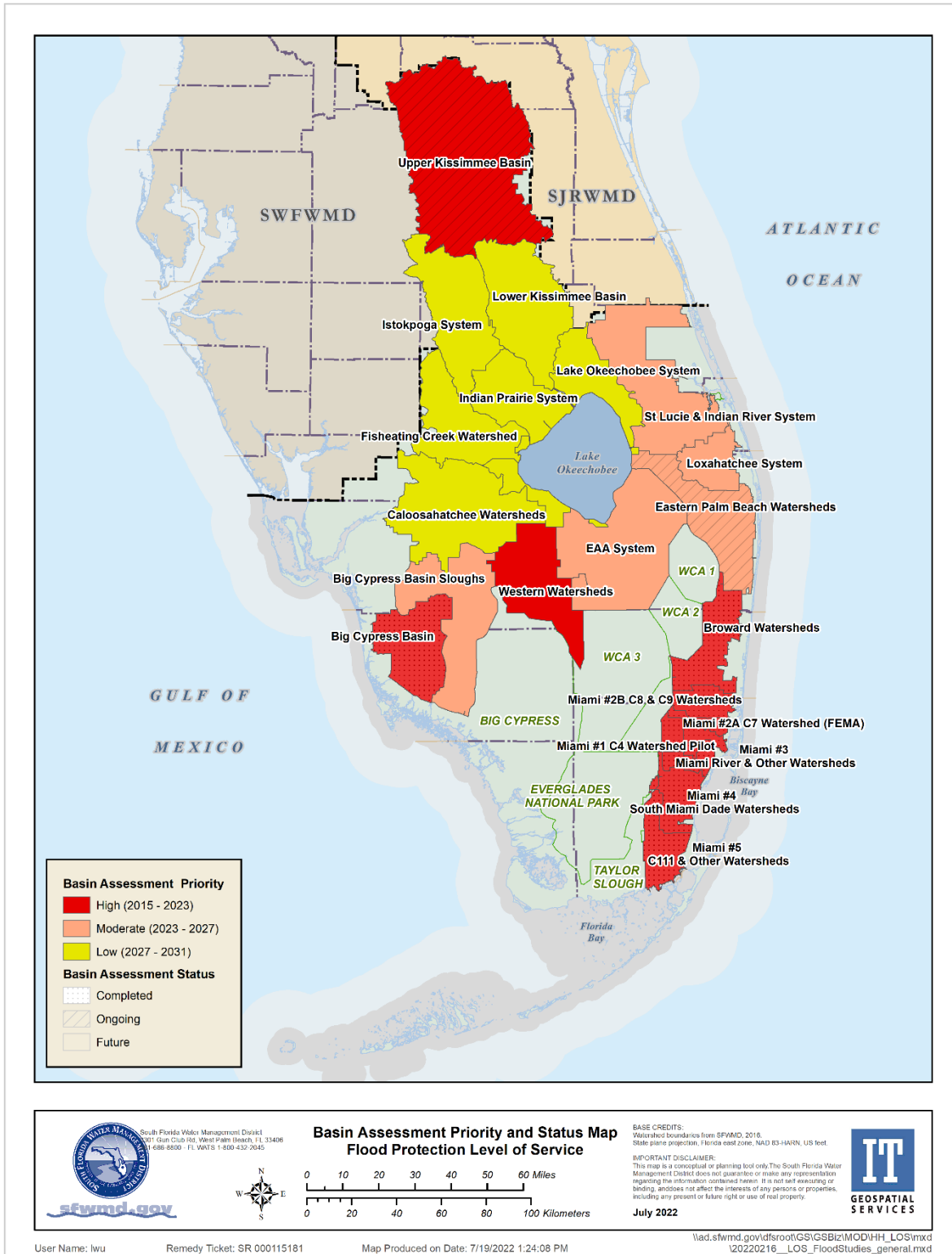

Figure 3-1: FPLOS Basin Assessment Priorities and Status of Implementation

Fully integrated and coupled hydrologic and hydraulic models have been developed and implemented as part of these studies to determine flood vulnerabilities and to support adaptation and mitigation planning. These advanced models simulate complex surface-subsurface water interactions and operational rules at each system structure, along with a range of storm surge and tidal boundary conditions, for different rainfall return frequencies and duration. Modeling outputs enhance technical understanding of the impacts caused by compound flooding drivers (rainfall, surge/tidal, and groundwater), which is critical to identify appropriate and effective resilience needs in coastal urban watersheds in South Florida. An approach for characterizing compound flooding and respective joint probabilities in transition zones is currently being validated.

Figure 3-3 and Figure 3-4 illustrate the resulting current and future overall Flood Protection Level of Service generally provided by existing infrastructure within each basin, as summarized in the final reports (summary and conclusions section) for the respective FPLOS Phase I (Flood Vulnerability) assessments completed for Broward and Miami-Dade Counties and for Big Cypress Basin. The Flood Protection Level of Service is illustrated in these maps by the respective rainfall return frequency event that results in flooding in each basin, simulated as part of the completed FPLOS Phase I Assessments. The overall Flood Protection Level of Service assigned to each basin is a combination of the results from six performance metrics measured within each basin for current and future conditions, and if both rainfall-induced flooding and storm surge flooding occurs simultaneously, as summarized in Table 3-1. It is important to emphasize that only portions of each basin might be showing inundation because of the simulated scenarios, meaning that the entire basin might not be inundated under the given return frequency. The overall level of service assigned to each basin represents portions of that basin that will have significant overland flooding simulated under that return frequency. Detailed results illustrating specific regions within each basin where simulated results show overland inundation are provided in the final FPLOS Phase I Reports.

A model crosswalk for the C-8 and C-9 basins and South Miami-Dade (C-1, C-100, C-102, C-103) was performed to compare the performance and results of the District's FPLOS and Miami-Dade County's modeling frameworks (MIKE SHE-MIKE Hydro and XPSWMM respectively) under current conditions and under the two-foot sea level rise scenario. Despite some differences in model assumptions and conceptualization, both models show similar results in terms of stage profiles along the canal prior to the coastal structure and similar flooding conditions when considering depths of more than one foot.

FPLOS Sea Level Rise Scenarios

The FPLOS Program assesses future conditions sea level scenarios. For that, three scenarios were defined relative to the 2015 or more current year conditions depending on a project starting year, assumed as current sea level (2015 CSL):

- CSL +1 foot
- CSL +2 feet
- CSL +3 feet

According to Section 380.093 (5) F.S., flood vulnerability assessments should be performed accounting for at least two local sea level rise scenarios, including the NOAA intermediate-low and intermediate-high sea level rise projections and two planning horizons for the years 2040 and 2070.

In Virginia Key, the 2022 NOAA sea level rise projections, relative to 2000, are detailed below. The observed change in annual MSL between 2000 and 2015 in this location is 0.073m or 0.24 feet.

- Intermediate Low 0.23m or 0.75ft (2040); 0.44m or 1.44ft (2070)
- Intermediate High 0.27m or 0.88ft (2040); 0.79m or 2.59ft (2070)

In Key West, the 2022 NOAA sea level rise projections, relative to 2000, are detailed below. The observed change in annual MSL between 2000 and 2015 in this location is 0.099m or 0.325 feet. The Figure below illustrates the NOAA 2022 Projections at the Key West Tidal Station.

- Intermediate Low 0.24m or 0.79 feet (2040); 0.44m or 1.44 feet (2070)
- Intermediate High 0.28m or 0.92 feet (2040); 0.80m or 2.62 feet (2070)

Table 3-1 summarizes the sea level rise projections relative to 2000, as presented by NOAA, and relative to 2015, as adopted in the FPLOS Program Sea level rise scenario formulation.

Table 3-1: Sea Level Rise Projections

NOAA 2022 Sea Level Rise Projections	Relative to 2000				Relative to 2015			
	2040 (m)	2040 (feet)	2070 (m)	2070 (feet)	2040 (m)	2040 (feet)	2070 (m)	2070 (feet)
IntermediateLow - Virginia Key	0.23	0.75	0.44	1.44	0.16	0.51	0.37	1.2
IntermediateHigh - Virginia Key	0.27	0.88	0.79	2.59	0.20	0.64	0.72	2.35
IntermediateLow - Key West	0.24	0.79	0.44	1.44	0.14	0.47	0.34	1.12
IntermediateHigh - Key West	0.28	0.92	0.80	2.62	0.18	0.60	0.70	2.30

FPLOS Future Rainfall Projections

To support the characterization of future extreme rainfall scenarios for flood resiliency planning, the SFWMD entered into a cooperative agreement with the United States Geological Survey (USGS) Caribbean–Florida Water Science Center and the FIU Sea Level Solutions Center to develop future depth-duration-frequency (DDF) curves based on available global climate model downscaled datasets (6).

The future extreme rainfall scenarios are determined by applying Change factors (CFs). CFs represent the calculated ratio of modeled future rainfall depths to historic rainfall depths for a given rainfall event and are applied to multiply the equivalent National Oceanic and Atmospheric Administration (NOAA Atlas 14) precipitation frequency estimates to determine increasing or decreasing future rainfall. Change factors greater than 1.0 (one) represent future rainfall increase, and less than 1.0 (one) represent rainfall decrease for a given event. The criteria for results selection and initial scenario formulation were based on technical consensus upon the evaluation of the available results and the best approach to represent associated uncertainty. The computed change factors are summarized in Figure 3-1 below, based on the 50% confidence interval of the model spread for a 1-day duration, 25-year rainfall frequency event and a 3-day duration, 100-year rainfall frequency event, using the ensemble of all model results for both medium-low and high future emissions scenarios compiled by 16 counties within the SFWMD boundaries.

With the goal of facilitating data accessibility, advancement of common practices, and regional consistency, spatial results are available through the SFWMD Resilience Metrics Hub’s Future Extreme Rainfall Change Factors for Flood Resiliency Planning in South Florida Web Application (7). The entire set of results for each global climate model dataset and additional percentile ranges are available at the USGS ScienceBase data release portal (8).

Current Flood Protection Level of Service

The current flood protection level of service generally provided by existing infrastructure in critical

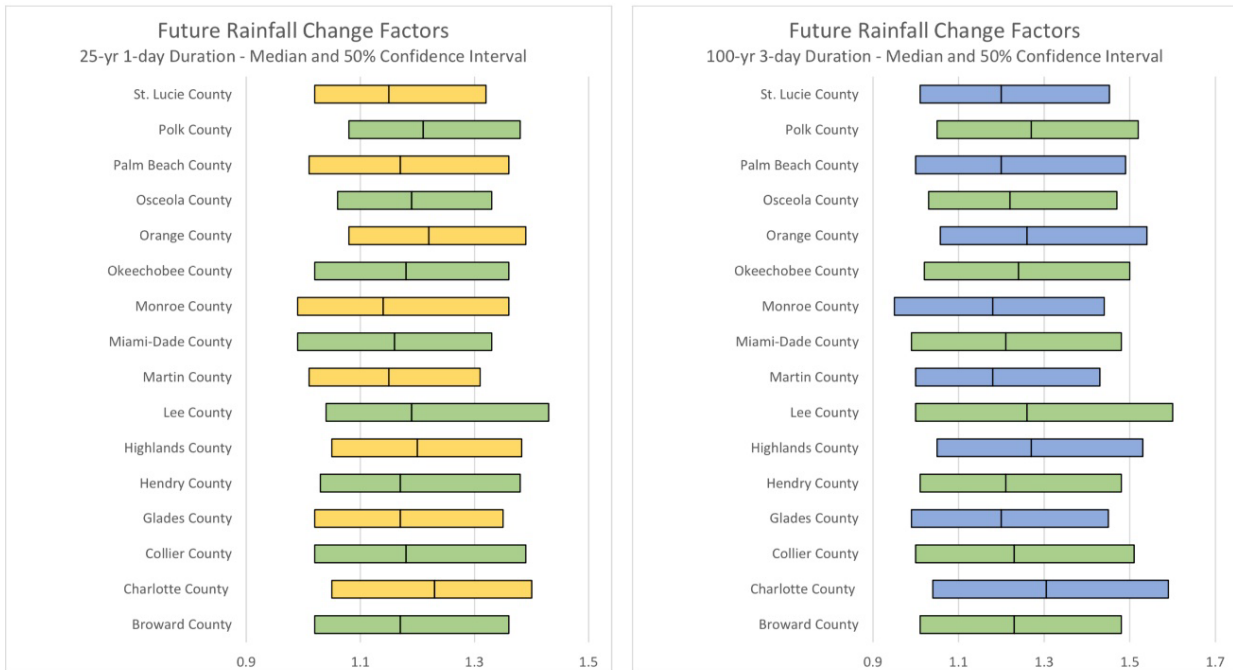

Figure 3-2: Summary of Future Rainfall Change Factors in South Florida

basins, predominantly located in Broward and Miami-Dade Counties is shown in Figure 3-3. The level of service is represented by the respective rainfall frequency event that results in flooding within areas of each basin, simulated as part of completed FPLOS Phase I – Flood Vulnerability Assessments.

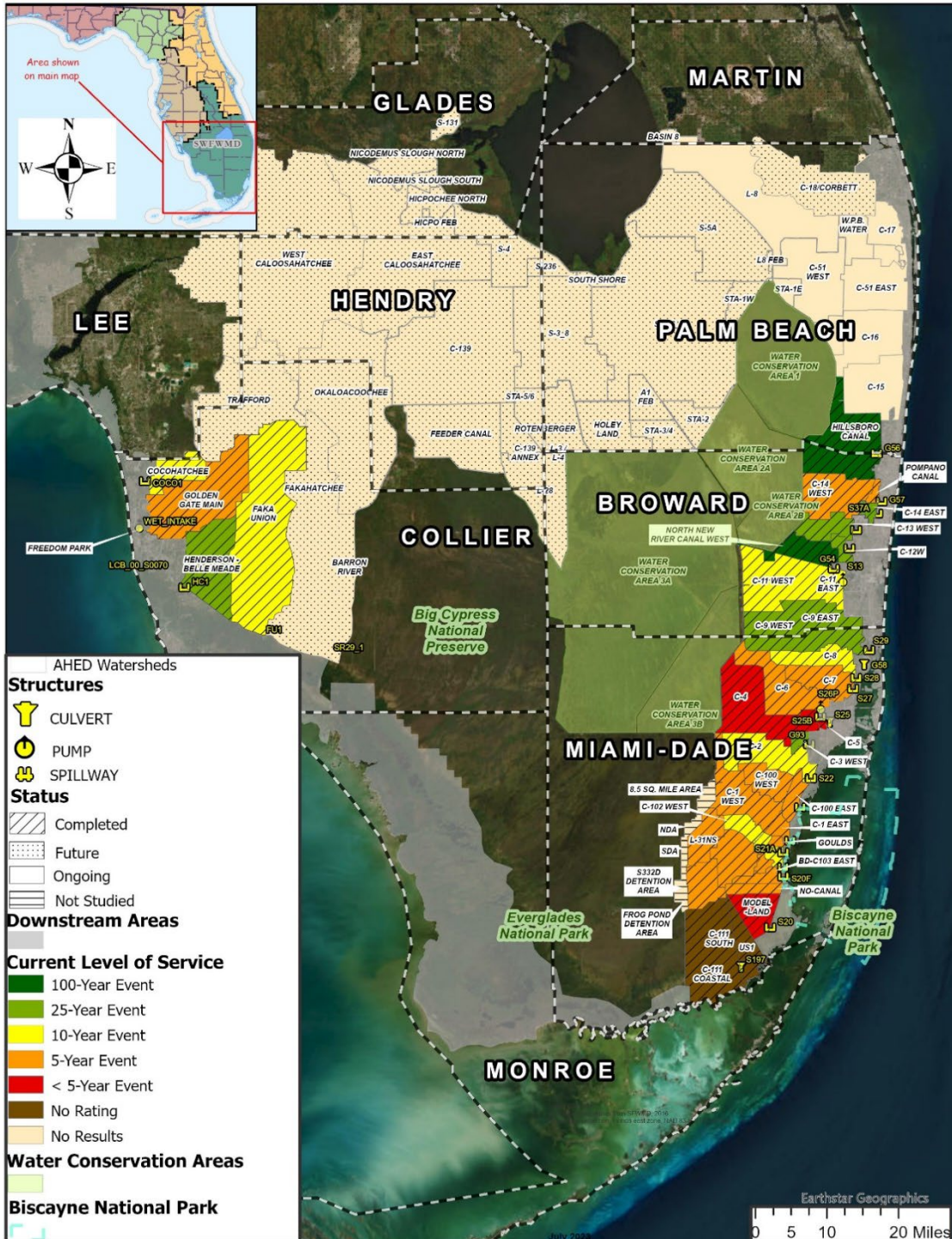

Figure 3-3: Current Flood Protection Level of Service

Future Flood Protection Level Service

The future flood protection level of service, under a 2-foot sea level rise scenario is shown in Figure 3-4. The figure depicts the level of service generally provided by existing infrastructure in critical basins, predominantly located in Broward and Miami-Dade Counties. The level of service is represented by the respective rainfall frequency event that results in flooding within areas of each basin, simulated as part of completed FPLOS Phase I – Flood Vulnerability Assessments.

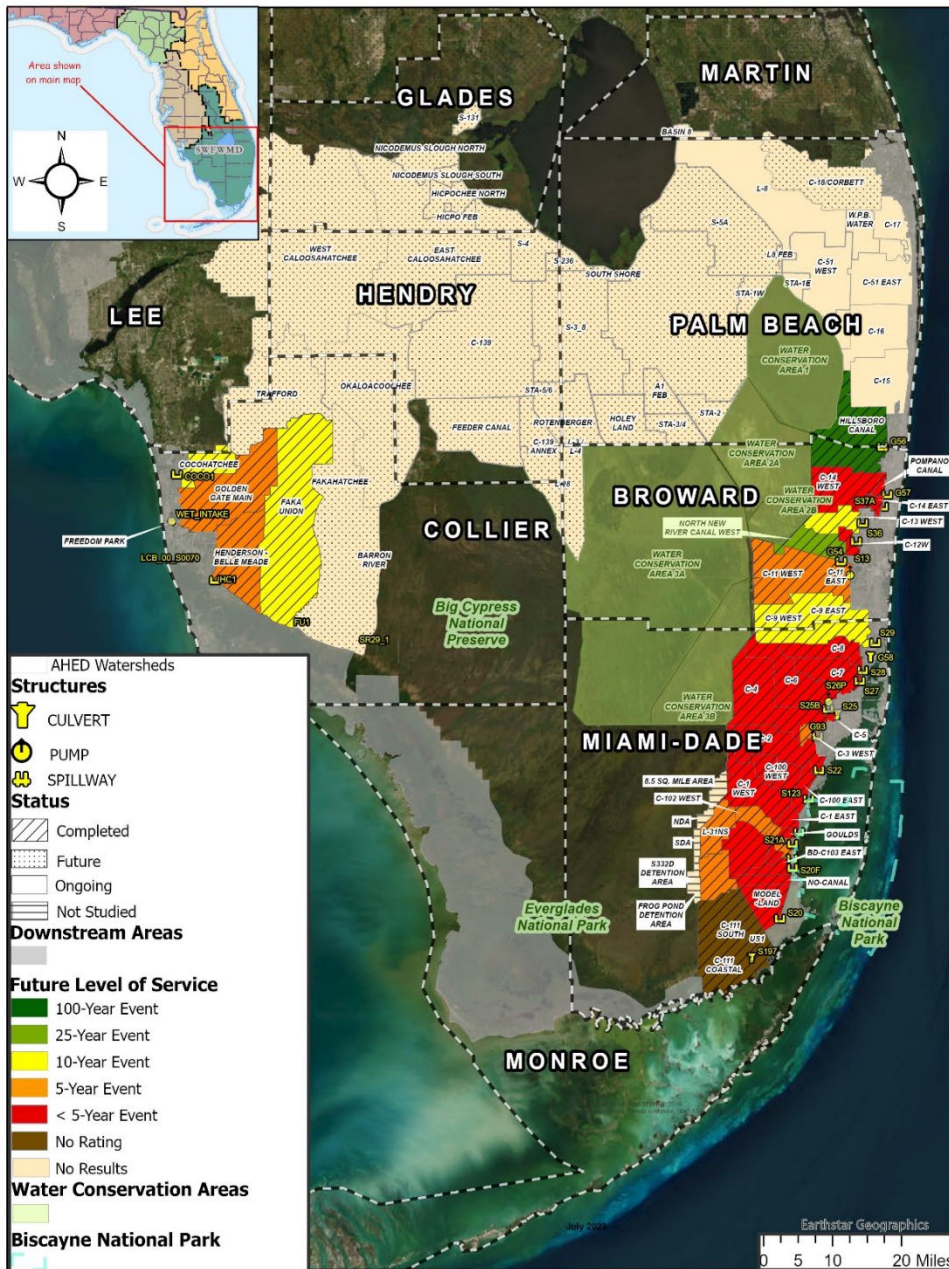

Figure 3-4: Future Flood Protection Level of Service

Table 3-2: Flood Protection Level of Service Summary Assessment for Maximum Stage in Primary Canals

Basins	PM1			
	Current Conditions	Future Conditions & 1 feet SLR	Future Conditions & 2 feet SLR	Future Conditions & 3 feet SLR
C-2	10-Year	5-Year	< 5-Year	< 5-Year
C-3W	25-Year	10-Year	5-Year	< 5-Year
C-5	25-Year	10-Year	< 5-Year	< 5-Year
C-6	25-Year	10-Year	5-Year	< 5-Year
C-8 ¹	10-Year	5-Year	5-Year	5-Year
C-9 ¹	25-Year	10-Year	10-Year	5-Year
Hillsboro ³	100-Year	100-Year	100-Year	100-Year
C-14 West ³	100-Year	25-Year	25-Year	25-Year
C-14 East ³	25-Year	10-Year	< 5-Year	< 5-Year
Pompano ³	100-Year	100-Year	100-Year	100-Year
C-13 West ³	25-Year	25-Year	10-Year	< 5-Year
C-12 West ³	25-Year	10-Year	< 5-Year	< 5-Year
North New River West ³	100-Year	100-Year	25-Year	10-Year
C-11 West ³	10-Year	10-Year	10-Year	10-Year
C-11 East ³	10-Year	5-Year	5-Year	5-Year
C-4 ⁴	10-Year	5-Year	<5-Year	<5-Year
C-7 ⁵	<5-Year	<5-Year	<5-Year	<5-Year
C-1 ⁶	C1 & CIN: 5-Year	5-Year or less	5-Year or less	5-Year or less
	CIN: 10-Year	5-Year or less	5-Year or less	5-Year or less
C-100 ⁶	5-Year	5-Year	< 5-Year	< 5-Year
C-102 ⁶	10-Year	10-Year	5-Year	5-Year
C-103 ⁶	5-Year	5-Year	5-Year	5-Year
C-111 COASTAL	100-Year	100-Year	100-Year	100-Year
US-1	N/A	N/A	N/A	N/A
L-31NS (Canal L-31NS)	5-Year	5-Year	5-Year	5-Year
L-31NS (C-102)	10-Year	10-Year	10-Year	5-Year
L-31NS (C-103)	10-Year	5-Year	<5-Year	<5-Year
C-111 AG (C-111)	25-Year	10-Year	10-Year	5-Year
C-111 AG (C-113)	10-Year	10-Year	10-Year	5-Year
C-111 AG (C-111E)	5-Year	5-Year	<5-Year	<5-Year
C-111 SOUTH (C-111)	100-Year	100-Year	100-Year	100-Year
C-111 SOUTH (C-111E)	100-Year	100-Year	100-Year	100-Year
MODEL LAND (Card Sound Rd)	5-Year	<5-Year	<5-Year	<5-Year
MODEL LAND (L-31E Canal)	5-Year	<5-Year	<5-Year	<5-Year

Table 3-2: Flood Protection Level of Service Summary Assessment for Maximum Stage in Primary Canals

Basins	PM1			
	Current Conditions	Future Conditions & 1 feet SLR	Future Conditions & 2 feet SLR	Future Conditions & 3 feet SLR
Cocohatchee ⁷	10-Year	10-Year	10-Year	5-Year
Golden Gate ⁷	5-Year	5-Year	5-Year	<5-Year
Henderson Creek ⁷	25-Year	25-Year	25-Year	10-Year
Faka Union ⁷	10-Year	10-Year	10-Year	5-Year

Table 3-3: Frequency of Flooding (PM5) for current and future conditions.

Basins	PM5			
	Current Conditions	Future Conditions & 1 feet SLR	Future Conditions & 2 feet SLR	Future Conditions & 3 feet SLR
C-2	25-Year	25-Year	10-Year	25-Year
C-3W	25-Year	10-Year	10-Year	25-Year
C-5	<5-Year	<5-Year	<5-Year	<5-Year
C-6	5-Year	5-Year	<5-Year	5-Year
C-8 ¹	10-Year	5-Year ²	<5-Year	10-Year
C-9 ¹	25-Year	10-Year ²	10-Year ²	25-Year
Hillsboro ³	100-Year ²	100-Year ²	100-Year ²	100-Year ²
C-14 West ³	10-Year*	5-Year ²	<5-Year	10-Year ²
C-14 East ³	25-Year	10-Year	<5-Year	25-Year
Pompano ³	<5-Year	<5-Year	<5-Year ²	<5-Year
C-13 West ³	25-Year	25-Year	10-Year	25-Year
C-12 West ³	25-Year*	5-Year	<5-Year	25-Year ²
North New River West ³	100-Year ²	100-Year ²	25-Year ²	100-Year ²
C-11 West ³	10-Year ²	10-Year ²	10-Year ²	10-Year ²
C-11 East ³	10-Year ²	5-Year	<5-Year ²	10-Year ²
C-4 ⁴	10-Year ²	5-Year ²	<5-Year ²	10-Year ²
C-7 ⁵	<5-Year ²	<5-Year ²	<5-Year ²	<5-Year ²
C-1 ⁶	10-Year	10-Year	<5-Year ²	10-Year
	10-Year	10-Year	<5-Year ²	10-Year
C-100 ⁶	25-Year	5-Year ²	<5-Year ²	25-Year
C-102 ⁶	5-Year	5-Year ²	5-Year ²	5-Year
C-103 ⁶	5-Year	5-Year ²	5-Year ²	5-Year
C-111 COASTAL	N/A	N/A	N/A	N/A

Table 3-3: Frequency of Flooding (PM5) for current and future conditions.

Basins	PM5			
	Current Conditions	Future Conditions & 1 foot SLR	Future Conditions & 2 feet SLR	Future Conditions & 3 feet SLR
US-1	10-Year	10-Year	10-Year	10-Year
L-31NS (Canal L-31NS)	10-Year	10-Year	10-Year	10-Year
L-31NS (C-102)	10-Year	10-Year	10-Year	10-Year
L-31NS (C-103)	10-Year	10-Year	10-Year	10-Year
C-111 AG (C-111)	5-Year	5-Year	5-Year	5-Year
C-111 AG (C-113)	5-Year	5-Year	5-Year	5-Year
C-111 AG (C-111E)	5-Year	5-Year	5-Year	5-Year
C-111 SOUTH (C-111)	10-Year	10-Year	10-Year	10-Year
C-111 SOUTH (C-111E)	10-Year	10-Year	10-Year	10-Year
MODEL LAND (Card Sound Rd)	10-Year	10-Year	10-Year	10-Year
MODEL LAND (L-31E Canal)	10-Year	10-Year	10-Year	10-Year
Cocohatchee ⁷	10-Year ⁸	10-Year ⁸	10-Year ⁸	10-Year ⁸
Golden Gate ⁷	5-Year ⁸	5-Year ⁸	5-Year ⁸	5-Year ⁸
Henderson Creek ⁷	25-Year ⁸	25-Year ⁸	25-Year ⁸	25-Year ⁸
Faka Union ⁷	10-Year ⁸	10-Year ⁸	10-Year ⁸	10-Year ⁸

¹ C-8 and C-9 FPLoS study was completed in 2021.

² The report does not contain sufficient information to confirm the LOS results. The proposed return periods were interpreted based on available information from the FPLoS study, including technical memorandums, canal profiles, flood maps, and appendices; thus, the results do not reflect the SFWMD assessment on the LOS as these are subject to technical interpretation and should be further reviewed by local stakeholders.

³ Broward County FPLoS study was completed in 2021.

⁴ C-4 FPLoS is a study produced by the H&H Bureau as a project deliverable for project 100888 (FPLoS, within the sea level rise projections) and completed in May 2016. The LOS design events assessed include the 5-year 72-hour, 10-year 72-hour, 25-year 72-hour, and 100-year 72-hour storm events and surge return periods, current sea level, and three future sea level rises (+0.34 feet, +0.8 feet, and 2.26 feet) focused on a 50-year planning horizon. The assessment of the +0.34 feet sea level rise scenario suggested a 10-Year LOS, +0.80 feet sea level rise scenario was reduced to a 5-Year LOS, and a +2.26 feet scenario to <5-Year LOS. These scenarios were used as a reference to produce a consistent FPLoS Summary Table, as most FPLoS efforts apply SLR +1 feet, SLR+2 feet, and SLR+3 feet as sea level rise conditions. For this reason, an SLR +1 feet scenario is defined as a 5-Year LOS, while for SLR +2 feet and +3 feet, a <5-Year LOS or “No Answer” may be appropriate.

⁵ C-7 FPLoS is a study funded by FEMA and completed in 2017. The LOS design events assessed include the 5-year 24-hour, 10-year 24-hour, 25-year 72-hour, and 100-year 72-hour storm events and surge return periods, current sea level, and three future sea level rises (+0.76 feet, +1.09 feet, and +2.21 feet). Under current conditions and the three future sea level rise conditions, the assessment concluded that along downstream of the Spur Canal junction (NW 22nd Avenue), the maximum stages between NW 17th Avenue and N Miami Avenue exceed the canal bank elevations in all events and the stages exceed the canal bank elevation during the 25- and 100-year events along the west of the 17th Avenue.

⁶ South Miami-Dade FPLoS study was completed in 2022.

⁷ Big Cypress Basin FPLoS study was completed in 2017.

⁸ The LOS results are tightly connected with the primary canal system.

FPLOS Next Steps

As described above, the FPLOS program is designed to allow for two new FPLOS Phase I Studies to be initiated each year. Upon completion of the key assessments, or if specific projects or actions require a more frequent reassessment, basins previously investigated will then be revisited to reassess the conditions, considering potential changes to the flood control infrastructure and more refined information on future conditions, including extreme rainfall projections. Flood vulnerability assessments for the St Lucie / Indian River System and Loxahatchee System, and the Western Basins are the upcoming Phase I studies included in the FPLOS implementation schedule.

This schedule also incorporates the initiation of at least one new Phase II study every year. The C-7 Basin Phase II study is the ongoing adaptation planning effort. Figure 3-5 shows the prioritization of basins for identifying adaptation and mitigation strategies across the District. Miami-Dade County, Broward County, Collier County, Lee County, and portions of the Upper Kissimmee Basin in Orange and Osceola Counties represent parts of the system where studies are anticipated in the near term.

Funding needs to implement the FPLOS program Phase I and Phase II studies are summarized in Chapter 10. Over the next five years, it is expected that flood vulnerability assessments will be completed for all the District's basins. Additionally, within the same timeframe, it is expected that adaptation and mitigation planning studies will be completed for 25% of the District's basins, subject to funding availability.

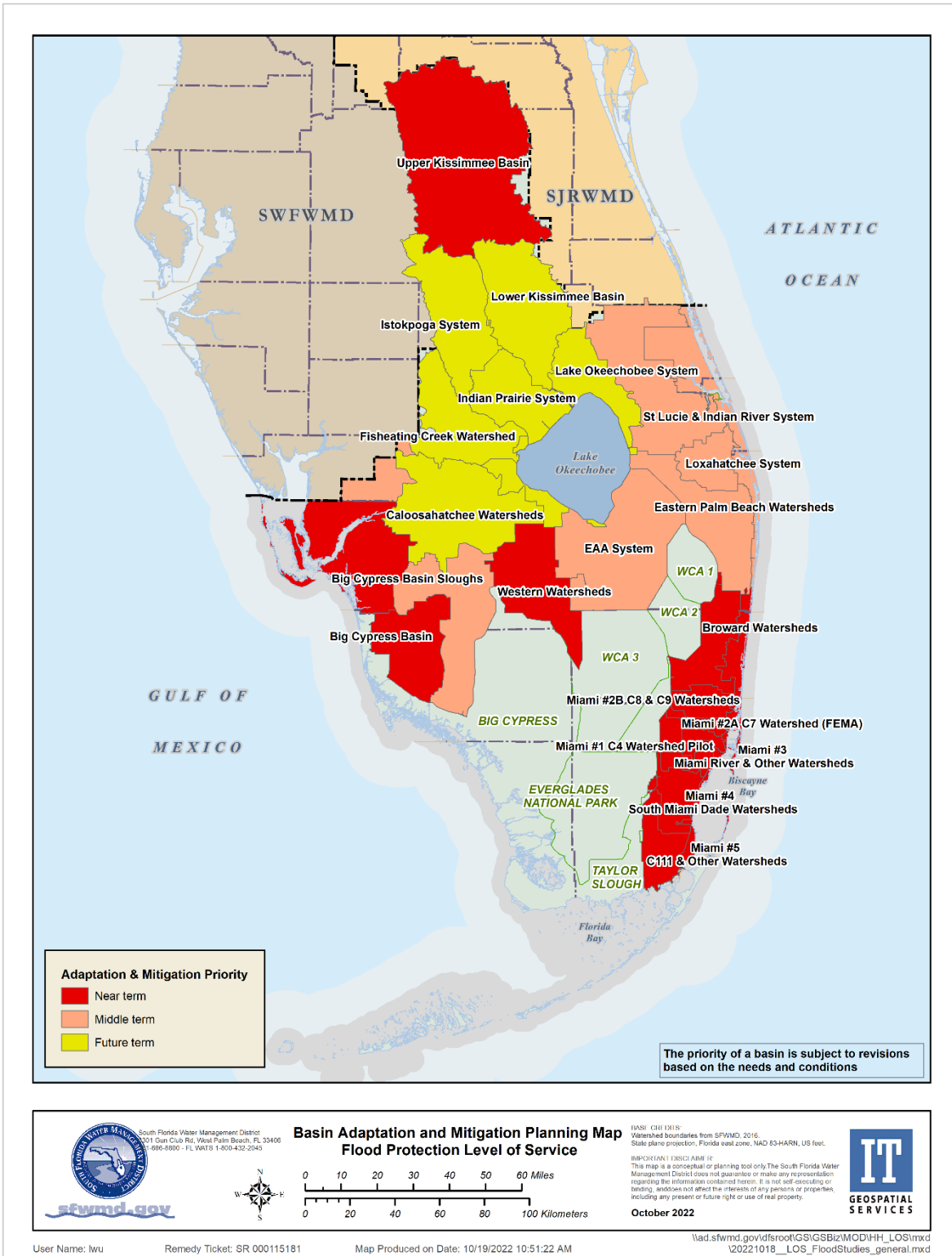

Figure 3-5: FPLOS Basin Adaptation and Mitigation Planning Map

SFWMD Flood Impact Assessment Tool (SFWMD-FIAT)

The District, as part of its Resiliency and Flood Protection Level of Service initiatives, has developed a Flood Impact Assessment Tool (SFWMD-FIAT). This tool helps support recommendations for flood mitigation and adaptation measures by providing cost benefits of implementing priority infrastructure investments. These recommended strategies are supported by advanced hydrologic and hydraulic modeling tools and assessments being implemented by the District's Flood Protection Level of Service Program – Phase II (Adaptation Planning) and incorporated into this Plan. The tool provides the ability to perform future flood damage cost estimates using multiple flood elevation/inundation scenarios developed as part of future conditions modeling efforts for various return frequencies to calculate an expected annual flood damage estimate (Figure 3-5). SFWMD-FIAT can calculate the flood damage costs for building structures and their contents, multiplied by the depreciated replacement value by the square foot and by the area of the building footprint to calculate the max potential damage of the structure, as well as roads and other selected infrastructure components, for multiple flood inundation scenarios. The user can run damage calculations for multiple flood inundation scenarios and return periods using a single desktop tool. The tool is user-friendly and versatile, as the economic damage curves and building values can be updated. The exposure data comes from the following official national data sources:

- County Supplied Building Footprints
- SFWMD Normalized Parcel and Land Use
- High-Resolution Topo-Bathymetric Data
- Navteq / HERE RoadsHAZUS Occupancy Types and Depreciated Replacement Values

The output files include post-processed summarized damages and risk in overview detail levels (Excel spreadsheet or shapefiles), including overall damage costs associated with combined structures and roads or by aggregation categories such as sub-basin, land use, tax use, census block, poverty level or critical infrastructure. The recommended projects within this Plan will have an associated cost-benefit ratio as part of the next planning round. The SFWMD-FIAT user manual is linked [here](#).

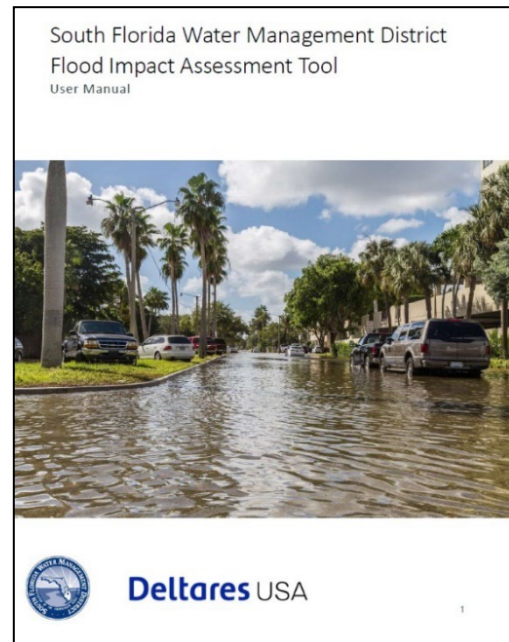

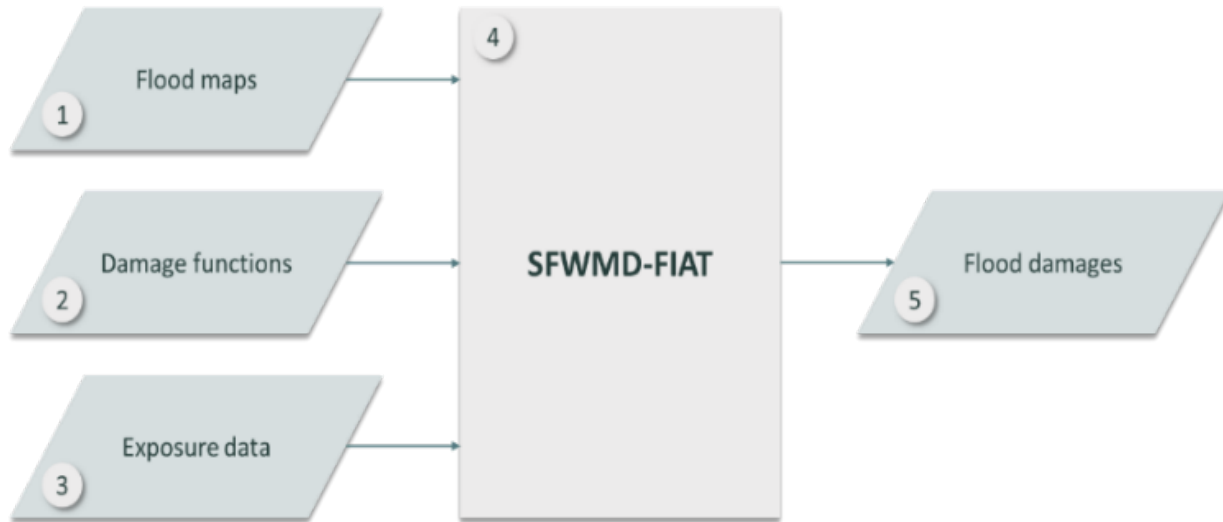

1	Flood maps	Selected per damage simulation in user interface
2	Damage functions	Prepared in set-up phase, coupled to exposure types
3	Exposure data	Prepared in set-up phase, developed per area of interest
4	Desktop Damage Tool	User interface and underlying Delft-FIAT damage assessment software
5	Flood damages	Object-level + aggregated tables and (optional) shapefiles of damages

Figure 3-6: Block Diagram of SFWMD-FIAT Tool

4: Nature-Based Solutions

Integrating Nature-Based Solutions

Nature-based solutions are defined as sustainable planning, design, environmental management, and engineering practices that weave natural features or processes into the built environment to build more resilient communities. These features can be used to conserve or restore ecosystem services and/or enhance natural processes in engineered systems. Application of nature-based solutions often generate social, economic, and environmental co-benefits that improve human living conditions. Green infrastructure refers to natural or semi-natural systems that provide water resource management options comparable to traditional gray infrastructure. Green and gray features can be combined to enhance overall system resiliency. Nature-based solutions and green infrastructure can be used to enhance flood protection against sea level rise and increased extreme rainfall caused by climate change, as well as manage water supply and improve water quality. Both gray and green infrastructure will be necessary to meet the challenges of climate change impacts, including sea level rise, along with basin-wide solutions to maximize the capacity of flood adaptation as well as achieve water quality and water supply benefits.

Nature-based solutions include features such as bioswales, rain gardens, green rooftops, living shorelines, wetlands, and artificial reefs that reduce stormwater flooding and storm surge impacts by absorbing wave energy and/or storing excess stormwater. Nature-Based features can be constructed using alternative construction materials such as concrete mixtures that enhance the ability of these features to create habitat, clean stormwater, and capture carbon. Alternative Green urban infrastructure features include green and blue features that are designed to collect, store, and slow stormwater runoff. Green and blue streets have porous surfaces that help to increase infiltration and direct runoff to trees planted in porous structural soil to increase storage and evapotranspiration, as well as improve water quality. Scaled up, these features have the potential to reduce flooding by using the natural water pumping (evapotranspiration) capacity of trees and other vegetation to slow the flow and provide enhanced storage, detention, retention, and infiltration options. Additionally, nature-based solutions also provide a multitude of water resource benefits by reducing net irrigation demand for green spaces and increasing retention and infiltration of surface water, which naturally recharges aquifers and assists in preventing saltwater intrusion in coastal areas (see Chapter 9).

The use of nature-based solutions has grown steadily over the past 20 years, supported by calls for innovation in flood risk management (FRM) and resilience planning. Communities, in general, have a strong desire to integrate nature-based solutions with traditional gray stormwater infrastructure. Accordingly, major grant programs, such as FEMA BRIC and Resilient Florida, assign higher scores to

proposed projects that include nature-based solutions, making them more competitive. In November 2022, the Federal government committed to ensuring that over \$25B in infrastructure and climate funding can support nature-based solutions and presented a roadmap that includes unlocking funding for nature-based solutions, workforce training, and updating guidance and policies (White House Council on Environmental Quality et al. 2022) such as:

- Better accounting for nature-based options in benefit-cost analyses is required by FEMA, USACE, and other federal agencies in their regulatory and funding programs.
- Revising floodplain management requirements to consider nature-based solutions for all projects that can affect floodplains and wetlands.

The District is committed to seeking nature-based solutions in addition to and integrating into existing and planned traditional gray infrastructure improvements and leveraging significant experience from the implementation of large ecosystem restoration and water quality efforts. Projects that “slow the flow” by using natural processes such as retention, infiltration, and evaporation/evapotranspiration to reduce runoff will be targeted. Additionally, the preservation and restoration of existing natural features will continue to be implemented as an important strategy to increase resiliency.

Different terms and definitions of nature-based solutions for risk reduction and adaptation are in use across the variety of organizations that are implementing these features. Related terms, though not necessarily synonymous, include ecological engineering, engineering with nature, living shorelines, natural flood management, and green infrastructure, to name a few. The common element among all these terms is the focus on working with natural processes for the benefit of people and ecosystems. For instance, [Engineering With Nature](#) (EWN) is an initiative of the USACE enabling more sustainable delivery of economic, social, and environmental benefits associated with water resources infrastructure (Bridges et al. 2018 and 2021). The USACE EWN Program works to better integrate traditional and nature-based infrastructure approaches by aligning engineering and natural processes for greater benefit. Incorporating natural and nature-based features into project scoping, planning, design, construction, and operations, from a foundation of inclusive and collaborative engagement creates a broad array of opportunities to meaningfully strengthen community resilience into the future. On February 2023, the USACE South Atlantic Division (SAD) became an EWN Proving Ground, recognizing that “partnering with nature is vital to delivering bold solutions to combat uncertainty and achieve long-term, sustainable solutions, and meaningfully strengthen community resilience into the future. EWN proving grounds are places/projects where innovative ideas are tested on the ground, and lessons learned are documented and shared, so others can learn from experience in building sustainable water resources infrastructure and

demonstrating a commitment to the broad integration of nature-based solutions. Examples of EWN principles have been extensively applied in Everglades Restoration projects. C-8 Basin Resiliency Project.

An example of a project that is proposing to use a combination of nature-based solutions and gray infrastructure is the District's C-8 Basin project in Miami-Dade County. The C-8 (Biscayne) Canal is the primary flood control feature that receives and conveys basin floodwaters by gravity through the S-28 Coastal Structure in North Miami to the sea. The objective of the project is to reduce flood risk as sea-levels rise and provide ancillary water quality benefits by restoring the basin's flood protection level of service and enhancing the quality of life in the region. The project includes a combination of structural measures and nature-based solutions (Figure 4-1), as follows:

- Replacement of the S-28 Structure with an enhanced structure and elevated components to withstand the impacts of sea level rise and climate change.
- Installation of a forward pump station adjacent to the S-28 structure to maintain basin discharge levels as sea levels rise.
- Construction of a flood barrier tying the S-28 Structure to higher ground elevations to assist in mitigating the impacts of sea level rise, storm surge, and saltwater intrusion.
- Enhancement of secondary canal banks to improve flood control throughout the basin.
- Construction of a temporary floodwater detention area utilizing vegetated berms and other green infrastructure components on a portion of the Miami Shores Golf Course near the S-28 Structure to provide temporary storage of floodwaters and reduction of stormwater runoff volumes during extreme rainfall events and provide ancillary water quality benefits.
- Installation of living shoreline along the C-8 Canal to assist in enhancing overall water quality and aquatic habitat.

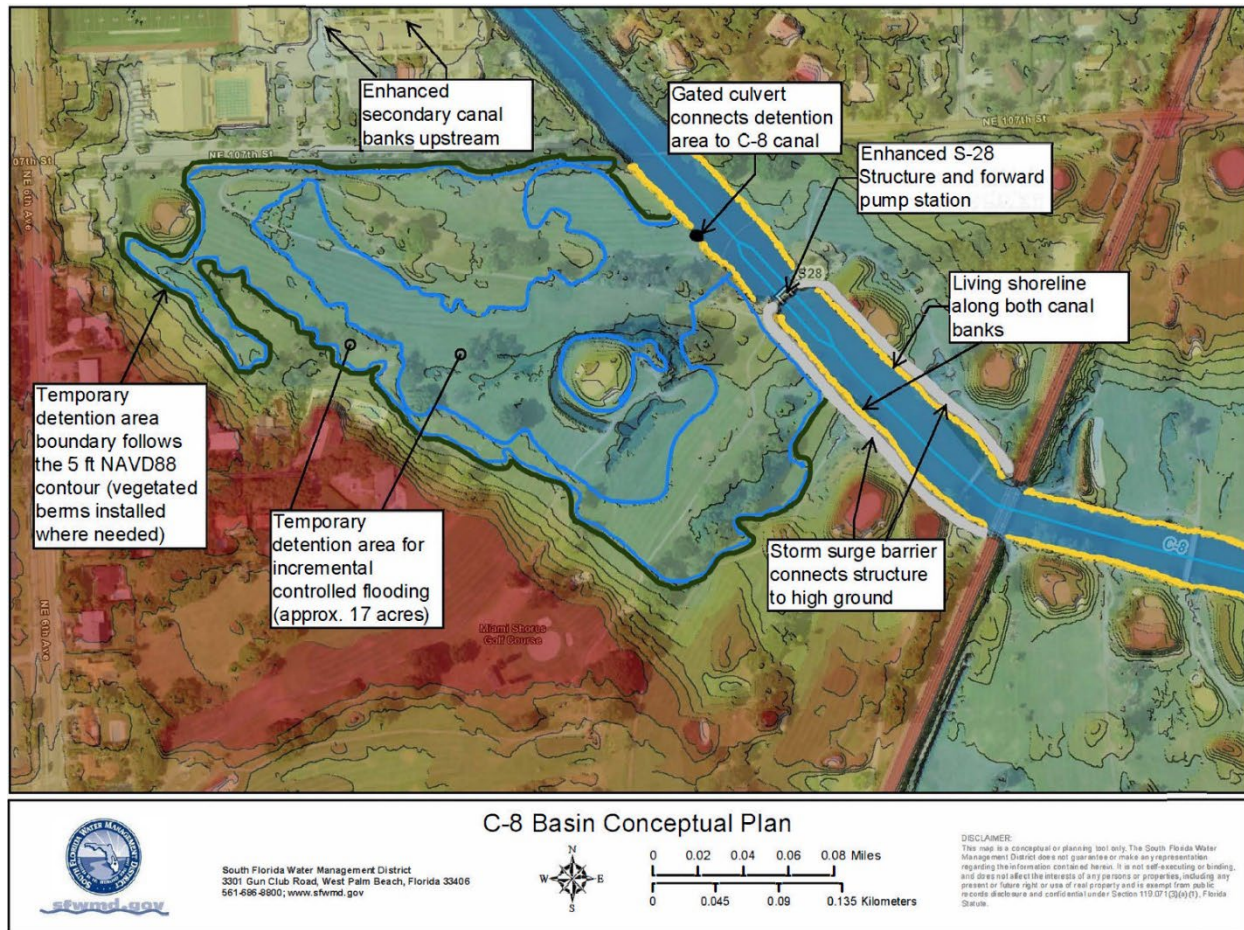

Figure 4-1: Conceptual Plan for the C-8 Basin.

The strategy to reduce peak runoff in this densely urbanized basin includes the implementation of a series of distributed storage solutions, as exemplified by the proposed project features, serving as pilot examples for the region. Ancillary benefits include improved fish and wildlife habitat, improved land value due to reduced flood risk and enhanced aesthetics, prevention of canal bank erosion, water quality benefits, and increased opportunities for recreation.

A more comprehensive list of examples of nature-based solutions that may be applied in South Florida is shown in Table 4-1 below. The table can be useful for identifying potential nature-based solutions for each water management/District mission type. The location of the proposed nature-based solutions feature and corresponding gray infrastructure that can be either replaced or enhanced by the nature-based solutions feature are identified.

Table 4-1: Nature-Based Solutions/Green Infrastructure

Water Management Topic/ District Mission		Green Infrastructure/Nature-Based Solution	Location				Corresponding Gray Infrastructure (at the primary service level)
			Watershed	Floodplain	Urban	Coastal	
Flood control	River/canal flood control	Reconnecting rivers/canals to floodplain		■			Levees and water control structures
		Wetland restoration/conservation	■				
		Constructed wetlands	■				
		Living shorelines/riparian buffers		■			
	Urban stormwater runoff	Green spaces (bioretention and infiltration)			■		Urban stormwater infrastructure
		Detention / Storage with associated “let it grow” strategies			■		
		Enhanced Infiltration / Groundwater recharge/storage			■		
		Permeable surfaces			■		
	Coastal flood control	Protecting/restoring mangroves, marshes, and dunes				■	Sea walls/forward pumps
		Protecting/restoring reefs				■	
Water Supply		Reconnecting rivers/canals to floodplain		■		Impoundments, reservoirs, water distribution systems	
		Wetland restoration/conservation	■				
		Constructed wetlands, other detention/storage options	■				
		Enhanced Infiltration / Groundwater recharge/storage			■		
		Green spaces (bioretention and infiltration)			■		
Water purification		Reconnecting rivers/canals to floodplain		■		Water treatment plant	
		Wetland restoration/conservation	■				
		Constructed wetlands	■				
		Green spaces (bioretention and infiltration)			■		
		Permeable surfaces			■		
Erosion control		Living shorelines/riparian buffers		■		Reinforcement of banks/riprap	
		Reconnecting rivers/canals to floodplain		■			
		Living shorelines/riparian buffers		■			
Water Quality		Reconnecting rivers/canals to floodplain		■		Water treatment plant	
		Wetland restoration/conservation	■				
		Constructed wetlands	■				
		Living shorelines/riparian buffers		■			

NOTES:
The table presents nature-based solution that may be applied in South Florida (9). Shaded boxes identify the location of each of the green infrastructure/nature-based solutions

Process for Assessing and Implementing Nature-Based Solutions

The initial step for assessing and implementing nature-based solutions, as proposed in this plan document, is to map available opportunities within a given basin through the analysis of land use maps (Figure 4-2) for the subject basin (step 1). A modeled flood layer can be added to the map to help identify portions of the basin that are more vulnerable to flooding. The map can also help to identify all lands within the basin that could potentially be used for implementing nature-based solutions. These lands can include multiple

types of land uses, such as institutional, extractive/borrow/holding pond areas, parks and recreation, wetlands, spoil areas, and District-owned Right-of-Way lands. Each parcel identified on the land use map can then be examined to determine ownership, size, elevation, and proximity to the flood control system. During this step, vulnerable and underserved communities are also taken into account to help choose appropriate project areas.

Step two involves selecting suitable nature-based solutions that can be implemented on the parcels identified as potential sites for nature-based solutions. For example, in the case of the C-8 Basin project, a municipal golf course was selected as a potential site for a temporary detention area for low-recurrence interval storm events. Once nature-based solutions have been selected, a nature-based solutions implementation process can be designed (step 3), and all stakeholders can be engaged to negotiate partnership opportunities and land use agreements (step 4). From there, project planning, funding, and ultimately implementation can proceed (step 5). Step 6 includes designing and implementing a monitoring program to evaluate the success of the nature-based solution in providing benefits such as increased flood protection, water supply, and/or water quality improvements, as well as co-benefits such as protection from threats like heat, drought, and wildfire. Finally, if the nature-based solutions prove successful in providing significant benefits, the nature-based solutions can be upscaled and applied throughout the basin and/or regionally across basins. These seven steps are summarized below:

- Identify opportunities (such as available land)
- Select and assess nature-based solutions and related actions
- Design nature-based solutions implementation processes
- Engage stakeholders, communicate co-benefits, and establish partnerships
- Implement nature-based solutions upon funding strategy definition
- Monitor and evaluate co-benefits across all stages

- Transfer and upscale nature-based solutions

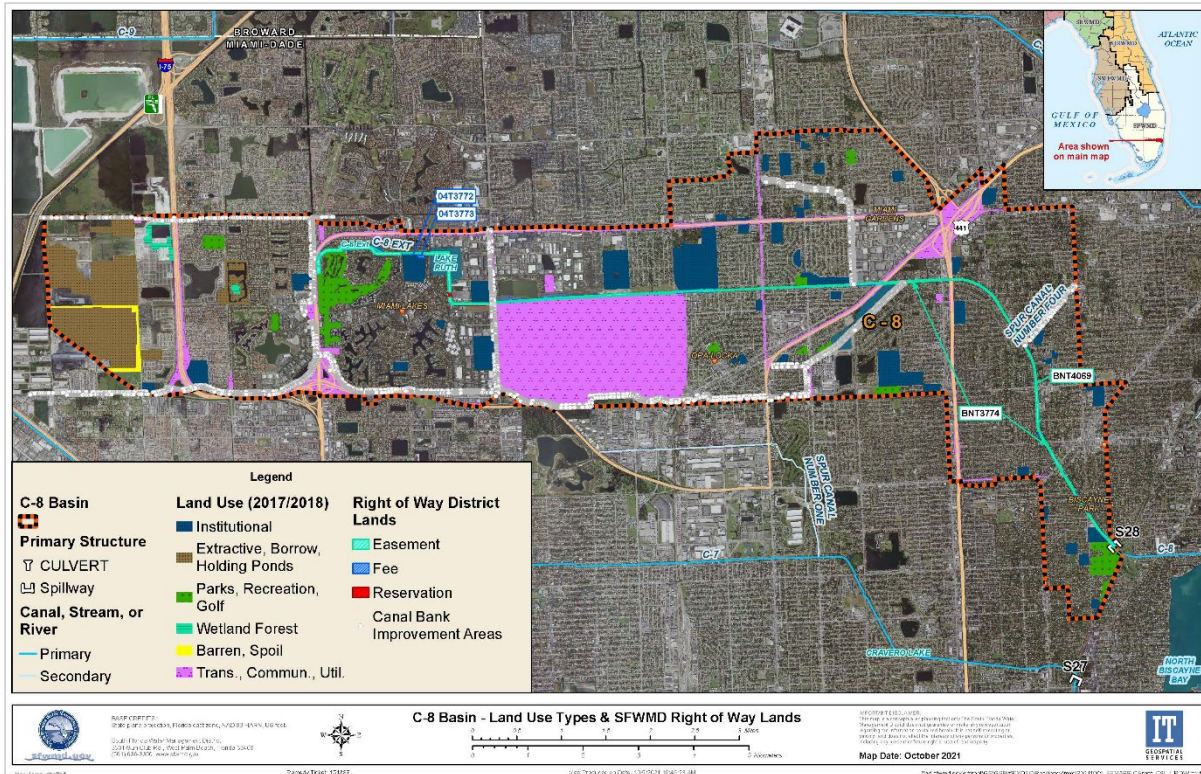

Figure 4-2: Land Use Types and SFWMD Right of Way lands within the C-8 Basin in Miami-Dade County.

Process for Evaluating Nature-Based Solutions - Estimating Direct and Indirect Benefits

The process for evaluating the benefits of the nature-based solution can use multiple tools that may include simple objective comparisons, professional estimates, standard engineering methods, empirical methods, combined hydrologic and hydraulic (H&H) models, and/or stand-alone hydraulic models. Each project, whether nature-based or gray infrastructure, should be evaluated for its ability to meet project objectives and the primary problem(s) it is intended to solve (flood control, water supply, water quality, environmental restoration, or combination thereof). Once the assessment for the project’s main intended purpose is confirmed, the project may also be evaluated relative to more comprehensive benefits related to District’s missions and incorporating stakeholder projects and components. The evaluation of nature-based solutions will also include considerations of operational impacts associated with the feasibility of project implementation to maintenance activities and impacts to the regulatory classification of nature-based solutions assets relative to the project design objective in cases where nature-based solutions are paired with gray infrastructure.

This section provides a general assessment of methodologies for projects with flood control benefits. Evaluations and tools selected are dependent upon the scale of the problem and the scale of the proposed improvement project. For instance, a basin-wide H&H model and/or regional simulation model are tools that can provide a good evaluation of a large-scale storage or constructed wetland project. Standard calculations and additional modeling within the project impact area might be used to identify and implement nature-based solutions and green infrastructure. However, some nature-based solutions projects may be too small to be entered into a regional scale model capable of estimating the benefit of more localized projects. In this example, the tools selected to evaluate the flood damage reductions of the proposed project may need to be professional estimates in lieu of modeling. Examples of assessment methodologies for flood control projects are listed in Table 4-2.

Table 4-2: Examples of Assessment Methodologies for Flood Control Projects

Water Management Topic		NBS	Corresponding Gray Infrast. Solution	Assessment Methodology Examples (scale dependent)
Flood Control	River/canal flood control	Reconnecting rivers/canals to floodplain	Levees and water control structures	<ul style="list-style-type: none"> • H&H model for large-scale projects • Standard engineering method to quantify additional storage
		Wetland restoration/conservation		<ul style="list-style-type: none"> • Standard engineering method to quantify additional storage
		Constructed wetlands/Flow Equalization Basin		<ul style="list-style-type: none"> • H&H model for large-scale projects • Standard engineering method to quantify additional storage
		Living Shorelines/riparian buffers		<ul style="list-style-type: none"> • Hydraulic models for large-scale projects • Professional estimates • Empirical methods
	Urban stormwater runoff	Green spaces	Urban stormwater infrastructure	<ul style="list-style-type: none"> • Standard engineering calculations and impact area-specific modeling • Empirical methods
		Permeable surfaces		<ul style="list-style-type: none"> • Standard engineering calculations and impact area-specific modeling • Empirical methods
		Green roofs		<ul style="list-style-type: none"> • Professional estimates • Empirical methods

Table 4-2: Examples of Assessment Methodologies for Flood Control Projects

Water Management Topic		NBS	Corresponding Gray Infrast. Solution	Assessment Methodology Examples (scale dependent)
	Coastal flood control	Protecting/restoring mangroves, marshes, and dunes	Artificial reefs/Sea walls/forward pumps	<ul style="list-style-type: none"> • Hydraulic models for large-scale projects • Professional estimates • Empirical methods
		Protecting/restoring reefs		

Performance Metrics for Nature-Based Solutions

Performance metrics are very useful tools for assessing a project's success, in addition to estimation of benefits. A performance metric is an element or component of the natural system or human environment that is expected to be influenced by the project to be evaluated or monitored as representative of a class of responses to the implementation of the project. They are project-specific and should be integrative of multiple aspects of the expected project result.

Performance metrics accomplish two evaluation goals 1) evaluation of expected project performance and 2) assessment of actual project performance. The first occurs during the project planning phase to assess the feasibility and cost/benefit of the project. The second monitors the implemented project over time and compares the actual outcome to the expected outcome. The performance metrics for the two goals may be and likely will be different.

Identifying appropriate performance metrics, as summarized in Table 4-3, requires data collection both before and after project implementation and a general understanding of the inner workings of the system. For example, for the C-8 Basin project, a potential performance metric would be the turbidity of the water column. It is an integrative measure of basin runoff, erosion, and a water quality parameter that impacts aquatic habitat. Turbidity data under multiple conditions (before and after rain events), both before and after project implementation, will be needed to assess the project's success. In addition, a suite of additional parameters will need to be collected to fully assess the impact of the project. With this information, the following evaluations can be made:

- Estimate the direction and magnitude of change in performance metric from the current state over the expected timeframe of benefit.
- Compare current performance measure status with its desired trend and target.
- Evaluate the consistency of monitoring results with anticipated results.
- Determine if unanticipated events are indicated by the data (outliers).
- Describe how these events are affecting the desired outcome.

Table 4-3: Potential Performance Metrics

Performance Metric	Pre-Project Data Availability	Post-Project Data Collection Effort
Salinity	High	Low
Turbidity	Medium	Low
Chlorophyll a	Medium	Medium
Nutrients	Medium	Medium
Flooding Frequency and Duration	Medium	Medium
Stage	High	Low
Flow	High	Low
Evapotranspiration	High	Medium
Biological Health & Biodiversity	Medium	Medium
Floodplain Connectivity	High	High
Wildlife utilization	Very low	High
Bank Stability	Low	Medium
Shoreline Change	Medium	Medium

Resiliency Projects with Nature-Based Solutions

Nature-based solutions are an important component of resiliency projects as they provide multiple benefits for both people and the environment. Projects in this plan document that include nature-based solutions are listed below and are detailed in Chapter 9. As the District continues to develop priority resiliency projects, nature-based solutions will be incorporated into traditional gray infrastructure to make the water management systems more resilient. Nature-based solutions are becoming increasingly important in building resilient communities, as they offer a cost-effective and sustainable way to mitigate the impacts of climate change and improve the ability of cities to withstand and recover from natural disasters. These solutions leverage the power of nature, such as wetlands, forests, and green spaces, to provide a range of ecosystem services that enhance the resilience of communities. For example, they can reduce the risk of flooding by absorbing excess water, preventing erosion, filter pollutants, and providing shade to reduce urban heat island effects. Moreover, nature-based solutions all have co-benefits, such as improving air and water quality, supporting biodiversity, and enhancing the overall livability of urban areas. The following projects include nature-based solutions and are linked to the project descriptions in Chapter 9.

1. Building Resiliency with Green and Gray Infrastructure, C-7 Basin of Miami-Dade County
2. Building Resiliency with Green and Gray Infrastructure, C-8 Basin of Miami-Dade County
3. Building Resiliency with Green and Gray Infrastructure, C-9 Basin of Broward and Miami-Dade County
4. C-9 Canal Widening and Enhancement with Nature-Based Features Project
5. Everglades Mangrove Migration Assessment (EMMA)
6. Mangrove Experimental Manipulation Exercise (MEME)
7. Corbett Wildlife Management Area Hydrologic Restoration and Levee Resiliency

5: Ecosystem Restoration Projects and Resiliency

Ecosystem Restoration Efforts

The South Florida Water Management District (District of SFWMD) has several programs that facilitate ecosystem restoration either directly or indirectly. One of the most important, the Comprehensive Everglades Restoration Plan (CERP, or the Plan), is designed to restore, preserve, and protect the South Florida ecosystem while providing for other water-related needs of the region, including water supply and flood protection. Restoration aims to achieve and sustain the essential hydrological and biological characteristics that define the Everglades ecosystem. To ensure project objectives are met, project-level performance measures and monitoring plans and system-wide performance measures and monitoring under the CERP's interagency Restoration, Coordination, Verification (RECOVER) program will assess ecosystem response to project implementation. With the uncertainty of impacts to these ecosystems from increases in precipitation, sea-level rise, and other effects of climate change, monitoring is critical to identifying adaptive management opportunities and ensuring the whole system is resilient in the long-term. Each CERP project has individual components with varying objectives, including wetland restoration, water storage, and water quality treatment; improved/reconnected hydrology and movement of freshwater for both environmental and human uses; and improved or restored habitat.

Another program specific to the Everglades is Restoration Strategies for Clean Water for the Everglades. This program's goal is to reduce phosphorus loading to the Everglades so that the historic plant and animal community may be restored. This is accomplished in two ways, by modifying and expanding existing Everglades Stormwater Treatment Areas (STAs) and by research to better understand phosphorus removal processes for improved management of the STAs. Everglades STAs are large, constructed wetlands designed to maximize phosphorus removal from surface water and will total approximately 64,000 acres when Restoration Strategies is complete. STAs not only provide clean, low-nutrient water to the Everglades, but they also provide significant carbon sequestration through peat accumulation.

The Northern Everglades and Estuaries Protection Program (NEEPP) focuses on protecting the watersheds of Lake Okeechobee, the Caloosahatchee River and Estuary, and the St. Lucie River and Estuary. Projects focus on improved water quality and water delivery to sensitive ecosystems. This includes working closely with the Florida Department of Environmental Protection, Florida Department of Transportation, and Florida Department of Agriculture and Consumer Services to implement nutrient source control measures to help meet total maximum daily loads (TMDLs) established for these water bodies.

Current and future projects will work in conjunction with other infrastructure projects, habitat restoration, and operational plans. These include Foundation Projects such as Kissimmee River Restoration, Modified Water Deliveries to Everglades National Park, C-111 South Dade Project, and Tamiami Trail Next Steps. The projects restore water flow, water quality, and habitat to critical areas of the District and improve resiliency to climate change.

All of these programs working system-wide, along with nature-based solutions, as introduced in the previous chapter, help restore South Florida's ecosystems, create healthy environments, and make them more resilient to climate change. Each, in its own way, provides ecosystem services that will bolster south Florida from the negative impacts of sea level rise, changing rainfall patterns and water availability, flooding, and loss of habitat.

This chapter provides high-level descriptions and examples of ecosystem restoration projects in the sections below and indicates how they support overall resiliency efforts. This chapter is not intended to be the source for detailed descriptions or the status of implementation of CERP Projects and other restoration projects. Extensive restoration efforts are already part of parallel and well-established planning and implementation efforts. The District acknowledges that CERP Projects and other South Florida restoration efforts strongly support this Plan's objective of reducing the risks of flooding, sea level rise, and other climate impacts on water resources and increasing community and ecosystem resiliency in South Florida. CERP Projects and other South Florida restoration efforts will increase the ability to balance water management for the benefit of people and the environment. Completed restoration projects will increase South Florida's ability to better manage anticipated extreme weather events and increase the ecosystem's future resilience in the face of warmer temperatures and other climate change impacts.

For the latest and most relevant information on CERP projects and the status of implementation, please refer to:

- [Everglades Restoration Initiatives](#) (10)
- [Ecosystem Restoration](#) (11)
- [CERP Project Planning | South Florida Water Management District](#) (12)
- [Integrated Delivery Schedule](#) (13)

Northern Estuaries and Everglades

Along the Atlantic Coast, the Indian River Lagoon-South Project includes the C-23, C-24, C-25, and C-44 Reservoirs and STAs for water storage and treatment of St. Lucie Watershed runoff. Water quality improvement and reduction of damaging freshwater flows will provide more suitable conditions (e.g., salinity) for aquatic organisms, including seagrasses and oysters, which are critical for creating buffer

zones for storm surge and wave erosion. On the Gulf Coast, the C-43 Reservoir and associated projects will provide the same benefits to the Caloosahatchee River and Estuary.

North, east, and west of Lake Okeechobee are water storage and water quality improvement projects that will reduce nutrient loading and improve water delivery to the Lake. Water clarity and depth are key components to a healthy submerged aquatic vegetation habitat critical for lake organisms. Lake levels also drive the amount of water sent east, west, and south, which impacts the estuaries and the Everglades' health. Some projects include the Nubbin Slough STA, Lower Kissimmee Basin Stormwater Treatment, and Grassy Island Flow Equalization Basin (FEB).

South of Lake Okeechobee, Restoration Strategies is improving STA performance to reduce phosphorus loading to the Everglades. At its completion in 2025, 6,500 additional acres of STA will have been built, and an additional 116,000 acre-feet of water storage will be available in FEBs. In addition, the treatment area in existing STAs will be increased through land-leveling efforts. Alongside these projects, District scientists have implemented a robust Science Plan designed to evaluate the mechanisms of phosphorus removal to improve STA performance and management decision-making. To date, scientists have completed nine of 21 studies. All studies will be completed at the end of 2024.

Central and Western everglades

The Central Everglades Planning Project (CEPP) includes the A-2 Reservoir (otherwise known as the Everglades Agricultural Area (EAA) Reservoir) and A-2 STA to store and treat Lake Okeechobee Regulatory Releases prior to sending flows to the Everglades; CEPP North to restore flows into northwestern Water Conservation Area (WCA) 3A, move water south, and construct tree island habitat; CEPP South to improve connectivity between WCA-3A/3B and northeast Shark River Slough; and CEPP New Water, to retain groundwater seepage from CEPP flows into northeast Shark River Slough. Providing increased hydration with low-nutrient water will result in greater peat formation, and thus carbon storage and increased marsh platform elevation to reduce impacts of sea level rise. Additionally, the Fish Habitat Assessment Program (FHAP) monitors seagrasses in Florida Bay, following trends in salinity resulting from insufficient freshwater baseflow.

The Western Everglades Restoration Project (WERP) will re-establish ecological connectivity, reduce the severity and frequency of wildfires, and restore low nutrient conditions through alterations to existing canals and levees to allow for sheet flow. Water will move from the Western Feeder Canal towards Big Cypress National Preserve, restoring freshwater flow paths, restoring water levels, and providing connectivity for flora and fauna. The reduction in the severity and frequency of wildfires and increased water availability will assist with carbon capture and the sustainability of the ecosystem.

The Picayune Strand Restoration Project (PSRP) is removing historic roads and restoring sheet flow across 55,000 acres of natural habitat, and maintaining flood protection for adjacent communities, with connections to downstream linkages to other systems, e.g., Everglades National Park, Collier Seminole State Park, Ten Thousand Islands National Wildlife Refuge, and Fakahatchee Strand State Preserve. Improved freshwater delivery to estuaries such as Faka Union Bay and Pumpkin Bay will improve the habitat for oysters and seagrass beds, which are critical for storm protection against erosion.

Southern Everglades

Broward County Water Preserve Areas reduce groundwater seepage from Water Conservation Areas 3A & 3B, improve water supply, and prevent saltwater intrusion. Biscayne Bay Coastal Wetlands (Phase I; BBCW) rehydrates coastal wetlands, reduces freshwater point source pollution releases, and redistributes surface water into Biscayne Bay. The Biscayne Bay and Eastern Everglades Restoration (BBSEER) project is currently in the planning phase and will include the C-111 Spreader Canal West and BBCW Phase II to improve the quality, quantity, and distribution of freshwater to Biscayne Bay, improve glades habitat in the Model Lands and Southern Glades, and improve the resiliency of coastal vegetation and habitat as they face changes in sea-level. An Adaptive Foundational Resilience (AFR) Performance Measure is being developed as a landscape-scale, holistic evaluation of the native mangrove and coastal marsh vegetation's ability to adapt to saltwater intrusion due to sea level rise by responding to the increased sheet flow volumes, reduced porewater salinities and improved hydroperiods predicted to occur with BBSEER restoration. There are two pilot studies needed to demonstrate how to implement the AFR throughout Florida. One is a small-scale multi-plot assessment of how mangroves will respond to a variety of drivers but with a focus on nutrients and the possible use of re-use water for restoration. This pilot is called: Mangrove Experimental Manipulation Exercise or MEME. The other pilot study is a large-scale assessment of Thin Layer Placement in Scrub Mangroves with a focus on using clean dredge material for enhanced elevation and soil accretion to enhance flood protection and foster natural adaption to sea level rise. This pilot is called: Everglades Mangrove Migration Assessment (EMMA).

Here are the questions that these two pilot studies, described in Chapter 9, will address when sources of funding are identified:

- Q1: Does phosphorus or level of planting density amendment contribute to the greatest ecosystem service value (plant production, nutrient accumulation, and C sequestration) and resilience (increase in sediment elevation that exceeds the rate of SL) with shallow sediment amendments?

- Q2: Does phosphorus enhance ecosystem service value and resilience the same regardless of planting density?
- Q3: How does phosphorus and level of planting density amendment influence ecosystem service value and resilience with a moderate level of sediment amendment under different salinity conditions?
- Q4: What combinations of sediment, phosphorus, and plant density amendments confer the greatest ecosystem service value and resilience? Do these vary with salinity conditions?

To plan for a sustainable South Florida ecosystem, it is important to identify ecological vulnerabilities to sea level rise and assess how water management could be directed to minimize saltwater intrusion, peat collapse (14), and land loss. Sea level rise projections for the next 50 years will threaten the structure and function of coastal wetlands in South Florida, and there is agreement among coastal scientists that sea level is rising at rates that will inundate most lowlands distributed along the coasts (14) (15 pp. 277-291) (16) (17).

These demonstration-scale pilot studies are nature-based management measures to increase coastal mangrove elevation and enhance the net belowground storage of carbon. They will document the efficiency and effectiveness of Thin Layer Placement to increase the adaptive capacity of Florida's coastal wetlands and keep up with sea level rise. It will assess the value of reuse water. Results are applicable to areas throughout the Gulf and Atlantic Coasts of Florida, where direct preservation, enhancement, and restoration of mangroves and other vegetative communities will build coastal resiliency, reduce storm surge damage, and create habitat for a large variety of fish and wildlife species.

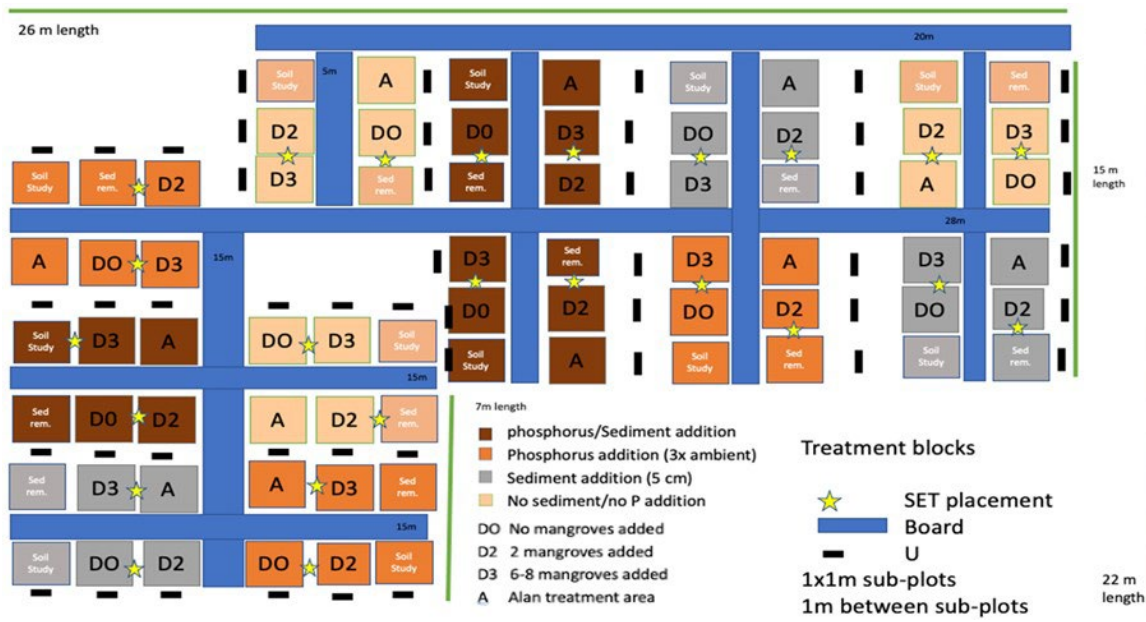

Figure 5-1: Experimental Design for Everglades Mangrove Migration Assessment

Biscayne Bay

The SFMWD acknowledges the delicate and valuable ecology of Biscayne Bay and the need for short-term and long-term efforts from State, regional, and local governments to address the effects of freshwater releases on water quality and ecology of the bay. The District is engaged in multiple ongoing efforts to specifically address these issues. These efforts range from assessment of flood control operation impacts on water quality of the bay to tool development through a Florida Department of Environmental Protection funded grant with Tulane University to develop a comprehensive hydrodynamic model with water quality capability for simulating impacts of freshwater flows on quality in the bay and the effect of multiple potential adaptation strategies.

The District, working with other agencies with a shared interest in addressing water quality in the Bay, is committed to identifying and implementing strategies that increase the resiliency of the entire flood control system through a coordinated effort with stakeholder and reducing the reliance on infrastructure in natural areas through long-term restoration. The District will partner with Miami-Dade County on the S-27 Coastal Structure Resiliency project to ensure that the proposed infrastructure projects adhere to the recommendations of the Biscayne Bay Task Force and prioritize Biscayne Bay health and resilience through monitoring. The District is also partnering with Miami-Dade County and Florida Department of Environmental Protection to identify and pilot innovative technologies that can be implemented to target nutrient removal, ultimately protecting the health of water systems upstream and downstream of District conveyance structures. Together, these projects, along with nature-based solutions and Green

Infrastructure, as recommended by the Biscayne Bay Task Force, create multi-faceted pathways that deliver protection to Biscayne Bay.

Ecosystem Restoration Projects Benefits and Potential Carbon Sequestration

As summarized above, comprehensive restoration efforts have been underway for the past 20-plus years by the District, in collaboration with local, state, and federal partners, to protect and restore South Florida's ecosystems. These systems are represented by four watersheds: Kissimmee River, Lake Okeechobee, Everglades, and Coastal Systems. The restoration of these vital parts of South Florida's ecosystems has been supporting the region's overall resiliency and the District's ability to better manage water for the benefit of people and the environment, with consideration of anticipated sea level rise and extreme weather events into the future. These efforts will continue to increase the ecosystem's future resilience in the face of warmer temperatures and other climate change impacts.



Figure 5-2: Restored Section of the Kissimmee River

In particular, the restoration of beneficial freshwater flows throughout the system slows down saltwater intrusion, promoting more sustainable aquifer recharge rates, healthier estuaries and bays, more stable coastlines, reduced marsh dry-outs, and greater coastal resiliency. Ecosystem restoration also results in increased quantity and quality of freshwater flow to and within the Everglades, higher flexibility and storage options to address water management seasonal needs, increased wetland acreage, and increased connectivity to coastal ecosystems. These initiatives also help mitigate the effects of climate change through carbon capture and storage in peat soils.

In addition to emphasizing the importance of continuing ecosystem restoration efforts and accounting for their resilience benefits, these efforts might seek to maximize the carbon uptake and storage capacity of wetlands and coastal ecosystems. The restoration and preservation of natural systems enhance organic carbon storage by reinstating the sedimentary biogeochemical conditions and soil stability in disturbed sites and increasing the living biomass and its capacity to sequester carbon dioxide (CE Lovelock et al., 2017). Restoration of historic flows to the Everglades, as part of CERP and the creation and improvement of Everglades STAs through Restoration Strategies, has a large carbon uptake potential by mitigating seagrass die-off, peat collapse, loss of ridge and slough habitat, subsidence, and restoration of agricultural

lands back to wetlands. Ecosystems within the restoration project footprint that can uptake and store atmospheric carbon include STAs, WCAs, mangrove forests, and submerged aquatic vegetation beds, including seagrass.

Monitoring Approach

Currently, the District does not collect carbon data as a matter of routine. This monitoring project is recommended for future funding. To provide quantitative information on carbon uptake and storage calculations, data collection efforts would need to be employed for each of the restoration projects to better represent their associated mitigation benefits and estimate resilience benefits.

These include the following:

- **Soil Carbon Characteristics:** measure soil bulk density and carbon concentration at multiple depth increments to capture short-term and long-term carbon storage.
- **Soil Accretion:** use surface elevation tables and feldspar marker horizons to measure soil surface changes and vertical accretion.
- **Eddy Flux Towers:** An Eddy flux tower, also known as an eddy covariance tower, is a tall tower equipped with sensors that measure the exchange of gases, such as carbon dioxide, methane, and water vapor, between the atmosphere and the land surface below. The tower has an anemometer (wind speed sensor) and a sonic anemometer (which measures wind speed and direction) at the top that measures the turbulence of the air as it moves past the tower. These measurements allow scientists to calculate the vertical and horizontal movement of gases. By combining these measurements with the turbulence data, scientists can calculate the rate of exchange of these gases between the land surface and the atmosphere. This information is important for understanding the role that ecosystems play in regulating the Earth's climate. For example, the rate of carbon dioxide uptake by plants during photosynthesis can be measured using an eddy flux tower, allowing scientists to track how much carbon dioxide is removed from the atmosphere by plants.

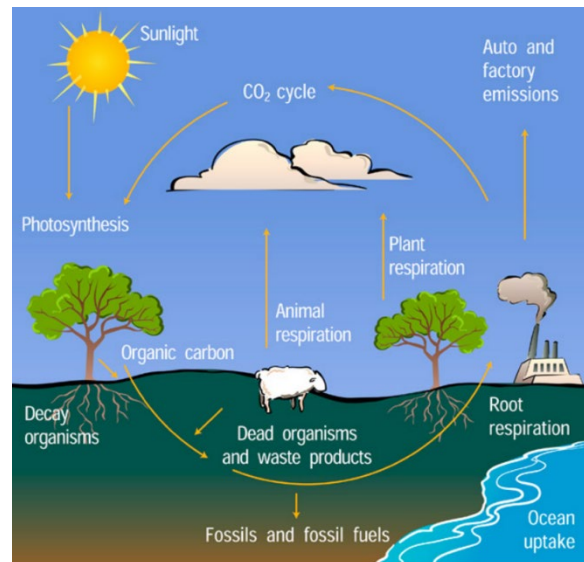

Source: University Corporation for Atmospheric Research

Figure 5-3: Carbon Cycle

- **Remote Sensing Data:** The District is actively investigating the potential for using satellite, radar, and lidar imagery to capture changes in plant biomass and land cover to determine the potential for carbon uptake. The use of satellite and radar imagery can provide a complementary approach to enhance the District’s current planning projects for carbon monitoring and further improve the accuracy and efficiency of carbon monitoring.

Employing these measurements across District restoration projects will provide accurate assessments of carbon capture and storage associated with the different ecosystem restoration efforts currently undertaken by the District and its partners and better estimate their benefits to climate resiliency. A full description of the carbon monitoring plan can be found in Chapter 10 – Priority Planning Studies. This monitoring plan was developed in partnership with the Everglades Foundation and Florida International University.

6: Water Supply Resiliency

Understanding Vulnerabilities

The South Florida Water Management District (District or SFWMD) is implementing initial efforts to better understand the water supply vulnerabilities as they relate to sea level rise, changing rainfall patterns and drought occurrences, evapotranspiration rates, and other related climate change impacts. These efforts include water supply planning, groundwater modeling, water resource protection, water conservation, alternative water supply development, regional and subregional water management, and saltwater interface mapping.

Water supply is one of the District's primary missions. The goal of the District's water supply plans and water use permit is to identify and promote the sustainable use of water supplies to meet reasonable-beneficial water needs while not causing harm to the water resources and related natural systems. Water use permitting and establishment of aquifer minimum levels protect aquifers district-wide by regulating water use withdrawals.

The SFWMD conducts water supply planning for five regions (Figure 6-1) encompassing the District: Upper Kissimmee Basin, Lower Kissimmee Basin, Upper East Coast, Lower East Coast, and Lower West Coast. Water supply plans (Plans) are developed in coordination with stakeholders and the public and look at least 20 years into the future and are updated every five years to stay current with growth trends. These Plans evaluate current and future water demands and identify water sources and strategies to meet these needs while sustaining water resources and the environment. These Plans help local governments and utilities in their facility and comprehensive planning efforts. Water supply plans include population and demand estimates and projections for at least a 20-year planning horizon, water source options, water resource evaluation and protection, proposed projects, and future water supply direction. As it is related to sea level rise, these Plans and projections consider saltwater intrusion, and future plans will evaluate sea level rise scenarios in a more comprehensive manner through the development of a variable density groundwater modeling effort (see Water Supply Vulnerability Assessment in Chapter 10).

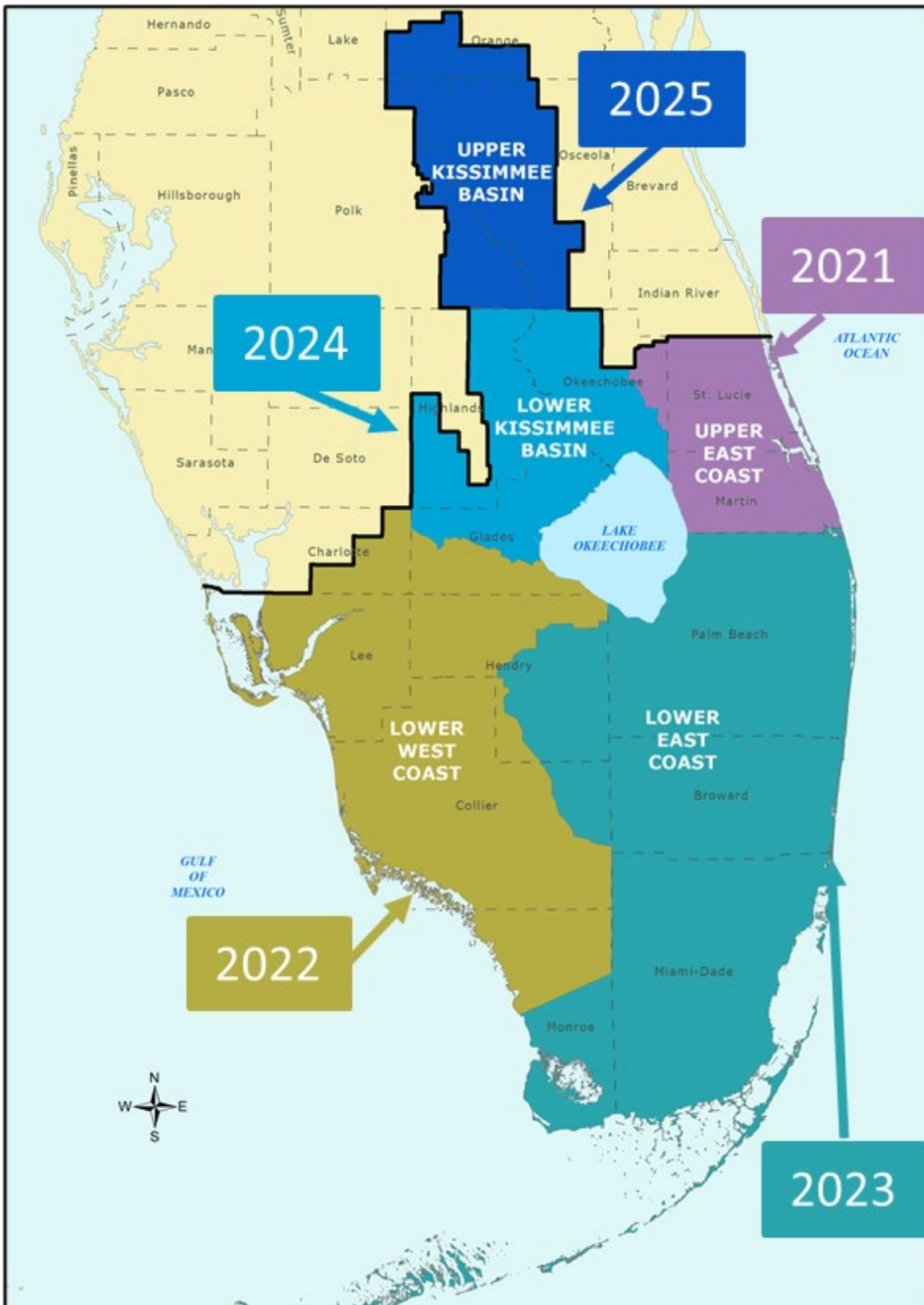

Figure 6-1: Regional Water Supply Plan Update Schedule and Respective Planning Areas

To support water supply plans and other initiatives, the District has several groundwater models that simulate current and future groundwater withdrawals and identify potential impacts on water resources, both for traditional fresh groundwater aquifer systems as well as the brackish Floridan Aquifer System (FAS). Single-density (freshwater) ground water system models can estimate drawdowns associated with those withdrawals, which can be useful in identifying areas of concern for saltwater intrusion but cannot directly model saltwater intrusion. The SFWMD is currently developing the East Coast Surficial Model (ECSM), which is a density-dependent groundwater model. The ECSM will be able to explicitly simulate the effects of sea level rise and potential movement of the saltwater interface and climate change on the surficial groundwater system. The ECSM includes most of the LEC planning region and the entire Upper East Coast (UEC) planning region and will be completed in 2024. In addition, the Lower West Coast (LWC) planning region is included in the District's Lower West Coast Surficial/Intermediate Aquifer Systems Model (LWCSIM). In the future, following the completion of the ECSM, it is envisioned that the LWCSIM will be upgraded to be density dependent as well.

In addition, with growing dependence on the brackish FAS as a result of limitations and restrictions on increased withdrawals from traditional fresh groundwater aquifer systems, the District has developed the West Coast FAS and East Coast FAS models. These density-dependent models simulate projected groundwater withdrawals to identify potential changes in water levels and water quality on a regional basis and maintain the FAS as a sustainable water supply source. Moreover, the District maintains a regional FAS monitoring network to monitor and detect changes in water levels and water quality. One concern is the upcoming of higher salinity water from lower portions of the FAS and effecting the treatability of the fresher Upper Floridan Aquifer. Utilities using the FAS have experienced increasing salinity in supply wells in many areas. This information is compiled and discussed in the respective water supply plans. For assessing longer-term evolving conditions, a Water Supply Vulnerability Assessment will utilize existing surface and fresh groundwater modeling tools to evaluate the effects of sea level rise and climate change (e.g., rainfall and evapotranspiration patterns) on water supplies (See Chapter 10). The outputs of the model runs will identify potential impacts on water resources and areas the District needs to focus on identification of strategies and projects that can increase water supply resilience. The Water Supply Vulnerability Assessment was initiated in 2023, with data preparation tasks, and has a 2-year estimated duration to complete. The Water Supply Vulnerability Assessment will look beyond the traditional water supply planning efforts and 20-year planning horizon and incorporate additional climate scenarios and a longer planning horizon. This more detailed evaluation of the vulnerability of water supply sources can help inform the development of new projects that will enhance the South Florida Region's water supply resiliency. This is part of an overall effort to help the District understand and plan around the complexities that factor into the current and future resilience of water supplies.

Responding Resiliently

In parallel to assessing water supply vulnerabilities and with the goal of ensuring that South Florida has a consistent and safe water supply for current and future generations, the District has been employing three overarching project strategies: protecting existing water sources, investing in alternative water supply sources, and capturing excess water or wet-weather flows. These strategies are currently incorporated as part of water supply plan development, among other District planning efforts, as well as regulatory efforts.

Subsequent sections highlight existing resiliency-related projects within the District boundaries. Many of the projects highlighted below achieve the goals of more than one of the above strategies. They may also have originated from within different District responsibilities, though they are highlighted here to emphasize the effect they have on making South Florida's water supply systems more resilient.

Protecting Existing Water Supply

Protection of existing water supplies is a resiliency strategy that ensures continual and safe water supply. This section highlights four of the District's protection-focused strategies: Saltwater Interface Monitoring, Salinity Control Structures and Canal Operations (Figure 6-2), and Regulatory Controls and Water Conservation.

The District develops saltwater interface maps at five-year intervals for coastal aquifers. The maps are based on salinity data from available monitor wells to determine the approximate location of the saltwater interface and any changes. These maps are published on the District's Website and presented in public workshops. The District also publishes chloride data and the saltwater interface maps on the [Resilience Metrics Hub \(14\)](#).

The District maintains canal and groundwater levels in the regional water management system during the wet and dry seasons to meet water supply demands needs, from urban demands to natural systems.

Optimization of canal and groundwater levels through the operation of the District's salinity control structures minimizes further inland movement of saltwater along the coast. The existing coastal structures were designed and built in the 1950s and are operated to maintain a pre-determined freshwater level in the canals, which locally increases the freshwater levels in the aquifer, further assisting with minimizing saltwater intrusion, especially during the dry season. Enhancements to Coastal Structures are being proposed as an important mechanism for salinity control in water supply management. The coastal Structures priority projects proposed in this plan (Chapter 9) will improve operational capacity and flexibility to further protect water supply sources into the future.

Regulatory Control occurs through water resource protection rules such as Minimum Flows and Minimum Water Levels (MFL), Water Reservations, and Restricted Allocation Areas (RAA). These have been adopted for several water resources in the District, including Lake Okeechobee, Kissimmee River, Biscayne Bay, Loxahatchee River, St. Lucie Estuary, and others. The District’s regulatory programs are designed to support reasonable-beneficial uses of water while implementing criteria needed to protect water resources from harm.

MFLs are defined as the minimum flows or minimum water levels adopted by the District Governing Board pursuant to Sections [373.042](#) and [373.0421](#), Florida Statutes, at which further withdrawals would be significantly harmful to the water resources or ecology of the area. A water reservation is a legal mechanism, authorized by Section [373.223\(4\)](#), Florida Statutes, to set aside water from consumptive uses for the protection of fish and wildlife or public health and safety. When a water reservation rule is in place, the volume and timing of water at specific locations are protected for the natural system.

Restricted Allocation Areas designated by the District are one regulatory mechanism designed to limit future uses beyond that which is already permitted to prevent harm to water resources. An example is the Lower East Coast Restricted Allocation Area Rule (2007), designed to protect existing supplies and prevent further harm to natural systems, as regulatory components of the Northwest Fork of the Loxahatchee River MFL and Everglades MFL recovery strategies. The RAA limits the allocation of water from these waterbodies to a base condition water use as described in the Applicant’s Handbook (SFWMD 2021a).

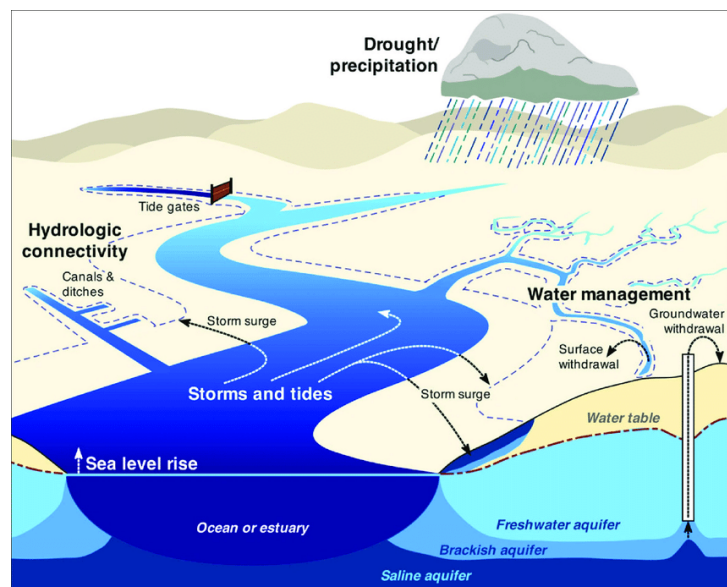

Figure 6-2: Coastal Hydrologic Cycle

Moreover, the District actively promotes water conservation to incentivize the efficient use of water and recognition that conservation can extend available supplies while deferring the need for more expensive alternative water supply sources.

Investing in Water Conservation and Alternative Water Supply Sources

In addition to protecting existing water resources, the District also encourages the development of new or alternative water sources to reduce dependence on freshwater resources and meet growing demands for water. These solutions include water conservation programs, the development and implementation of increased use of reclaimed water, the use of brackish groundwater sources such as the Floridan Aquifer System (FAS), additional surface water storage options, and utilizing desalination of sea water or other high salinity sources. These solutions have been implemented across the District in various capacities and have been tried and proven as a sustainable, resilient strategy for many communities around the world. Since 1997, the District, in cooperation with FDEP, has provided over \$243 million in state cost-share grant funding towards 530 Alternative Water Supply (AWS) projects that produced 523 million gallons of capacity per day. Additionally, the District contributed approximately \$9 million toward 260 water conservation projects that have an estimated water savings of 5 billion gallons of water per year, or 13.6 million gallons of water per day, since 2003.

Water conservation is a cornerstone to using water efficiently and effectively. The District has many programs, partnerships, and materials dedicated to promoting water conservation across all use classes and sources. These programs range from demand-reducing strategies like [Florida Friendly Landscaping](#) to the commercially focused [Florida Water Star](#). These and other District conservation programs incentivize users to be intentional about water consumption by providing grants, rebates, and other funding sources, as well as guidance and conservation information. Over the last two decades, per capita water use has decreased by 30% as a result of water conservation efforts being advanced by the District, utilities, and local governments. The District continues to promote and encourage water conservation to realize additional savings. With an estimated 50% or more of residential water use being used for irrigation, there is a focus on promoting efficient irrigation. Towards this end, this District has been working with local governments to adopt year-round irrigation ordinances to limit the number of days and hours irrigation is allowed, as well as encouraging the use of advanced irrigation controllers that account for recent rainfall, rainfall forecasts, and soil moisture. Education and outreach are an integral part of promoting efficient irrigation.

Florida is a national leader in water reuse, reusing nearly 900 million gallons per day (MGD) of reclaimed water to conserve freshwater supplies and recharge freshwater aquifers. There are over 100 reuse facilities in the District, reusing about 300 MGD of reclaimed water for beneficial purposes, including irrigation of golf courses, residential lots and other green space, ground water recharge, environmental enhancement, and industrial purposes. However, there is approximately 590 MGD of potentially reusable water that is

currently being disposed of through ocean discharge or deep injection wells in the District, primarily on the Lower East Coast. The biggest obstacle to further development is the identification of feasible reuse options in highly urbanized areas, the cost of treatment to meet water quality requirements and related infrastructure, and funding. There are over 40 reverse osmosis water treatment plants treating brackish groundwater from the FAS throughout South Florida with a combined capacity of approximately 300 MGD. Utilizing brackish groundwater from the FAS to meet future demands reduces the stress on existing surficial aquifer system resources, thereby reducing the potential for increased saltwater intrusion. The FAS is geologically isolated in South Florida from the overlying surficial aquifer system, and due to its already brackish water quality and depth nearly 1,000 feet below the surface, it does not face the same acute climate risk from sea level rise as the freshwater surficial aquifer system. Though brackish water sources and related treatment systems are more expensive to operate, less efficient, and produce a brine concentrate needing disposal, the use of brackish water is a sustainable water source as it has a smaller environmental impact with manageable waste streams, in addition to reducing demand on the surficial aquifer system. Utilities are planning to increase withdrawals from the FAS to meet projected growth beyond current freshwater allocations. In the past 20 years, desalination capacity in the SFWMD has increased by 480% through the addition of 28 reverse osmosis plants, mostly brackish groundwater treatment systems.

Finally, seawater desalination is a potential option explored by coastal communities throughout the world. Unfortunately, the relatively higher cost and energy associated with seawater desalination treatment processes reduce its utilization and increase its carbon footprint. Yet, seawater desalination remains an option for water supply development under more critical future conditions. However, advances in desalination technology are decreasing energy demands and increasing recovery efficiencies. There are two seawater desalination facilities in the District, both located in the Florida Keys, serving primarily as a back-up supply.

Below are a couple of examples of the development of alternative water supplies in the District:

- Reuse Facilities: Oasis Water Reclamation Facility - The District's alternative water supply funding program has contributed more than \$100 million to reclaimed water projects, including the City of Pompano Beach's Oasis Water



Figure 6-3: Reclaimed Water System

Reclamation Facility – This facility has reused over 24 billion gallons of reclaimed water over the last 3 decades.

- Brackish Groundwater: Orlando Southeast Water Treatment Plant Lower Floridan Aquifer Wellfield Phase 1 – In 2021, the Orlando Utilities Commission received a District’s brackish water alternative water supply development grant. The total project cost is expected to be over \$95 million and is expected to provide the Orlando area with an additional 10 MGD of public water supply. Examples of municipalities using brackish sources along the coast include Jupiter and Lake Worth Beach.
- Seawater Desalination: Florida Keys Aqueduct Authority (FKAA) Kermit H. Lewin RO Facility – The existing seawater desalination facility at this site will be replaced with a new facility that will double the current desalinated seawater supply to 4 MGD. Approximately 75% of the plant was funded by a hurricane disaster recovery grant and its specifications are resiliency focused.

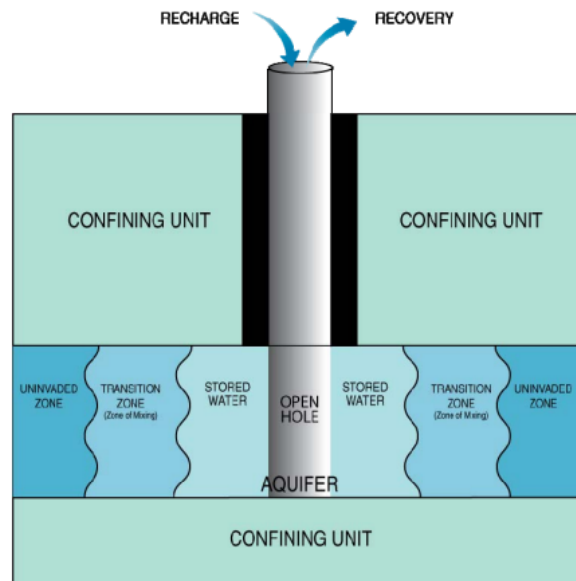

Figure 6-4: Aquifer Storage and Recovery

Saving for a Non-Rainy Day

Retaining wet-weather flows to use when it is dry is one of the most tried and proven resiliency strategies for water supply and is another alternative water supply development strategy being supported by the District. From a regional perspective, the District captures surplus water primarily through the operation of the regional water management system. This system includes reservoirs and Water Conservation Areas (WCAs). The development of large-scale Aquifer Storage and Recovery (ASR), currently being designed and tested by the District north of Lake Okeechobee, will provide another option.

The District manages both natural systems and man-made reservoirs that serve as water supply primarily for the environment and, to a much lesser extent, water users such as water supply utilities and agricultural irrigation, among others. Natural systems

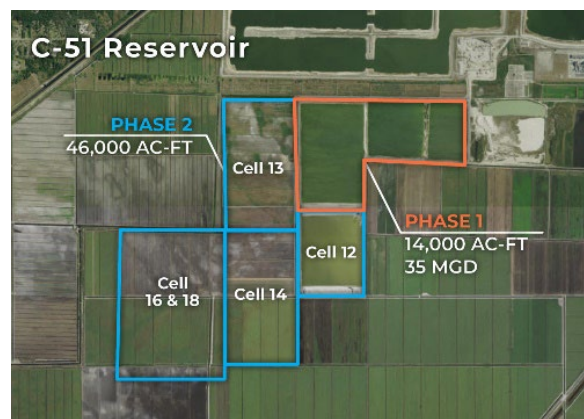

Figure 6-5: C-51 Reservoir Project

used to retain surface water include WCAs / Water Management Areas (WMA), which are large swaths of land that retain water as well as facilitate groundwater recharge. Built-out reservoirs have been developed throughout the District and are often integrated into flood protection as a place for flood waters to be conveyed in addition to their water supply uses.

ASR wells store excess water primarily during the wet season into confined aquifer systems, saving it to be extracted during dry conditions. The District has a plan to construct up to 55 ASR wells north of Lake Okeechobee as part of the Comprehensive Everglades Restoration Plan (CERP). There are existing ASR wells used by utilities for water supply, such as the wells in Boynton Beach, West Palm Beach, and Marco Island. In 2015 and 2018, the District published a comprehensive ASR study that confirmed further ASR development as a feasible solution to provide beneficial water storage and availability.

Below are examples of regional and local-focused water storage projects:

ASR: Marco Island's ASR Wells

Marco Island utilizes four water supply options to meet the drinking water and irrigation demands of the community: fresh surface water from Marco Lakes/Henderson Creek, brackish groundwater, reclaimed water, and surface water stored in ASR wells. Since 1997, Marco Island has developed seven ASR wells that store surface water from Marco Lakes/Henderson Creek during the rainy season for later use during the dry season. Marco Island estimates they have established a one-billion-gallon freshwater reserve in the brackish FAS through their ASR program. Marco Island recovers 2 to 5 MGD from the ASR wells during the dry season to meet consumer demand when surface water availability is limited.

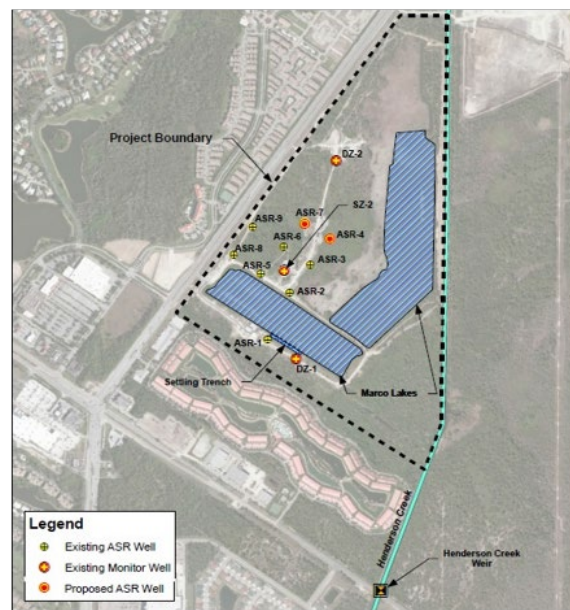

Figure 6-6: Marco Island's ASR Wellfield

Reservoirs: Everglades Agricultural Area (A-2) Reservoir

The project includes two major features: a treatment wetland that will improve water quality and a reservoir that will store excess water from Lake Okeechobee. The District is responsible for constructing the 6,500-acre wetland known as a Stormwater Treatment Area (STA). The District began construction

ahead of schedule in April 2020, and the project is expected to be completed in 2023. Additionally, the U.S. Army Corps of Engineers (USACE) is building the reservoir component, which will hold 240,000 acre-feet of water. The USACE began construction in 2023 and is estimated to be completed in 2030. The total project cost is expected to be just over \$2 billion.

New WMA/WCA: SJRWMD C-10 WMA

In 2021, the St. Johns River Water Management District (SJRWMD) received a \$20 million grant as part of the FDEP Resilient Florida Program to develop the C-10 WMA. This project consists of a 1,300-acre WMA, pump station, outfall structure, 4 miles of new levee, and improvements to an existing federal levee. The project will collect water from a series of drainage canals to increase storage of water currently discharging to the Indian River Lagoon and direct flow to its historic drainage way towards the St. Johns River. The project is anticipated to provide 7.9 MGD of alternative water supply for the Upper St. Johns River. While not within SFWMD boundaries, this is a recent example of the development of a new WMA for resilient water supply in Florida.

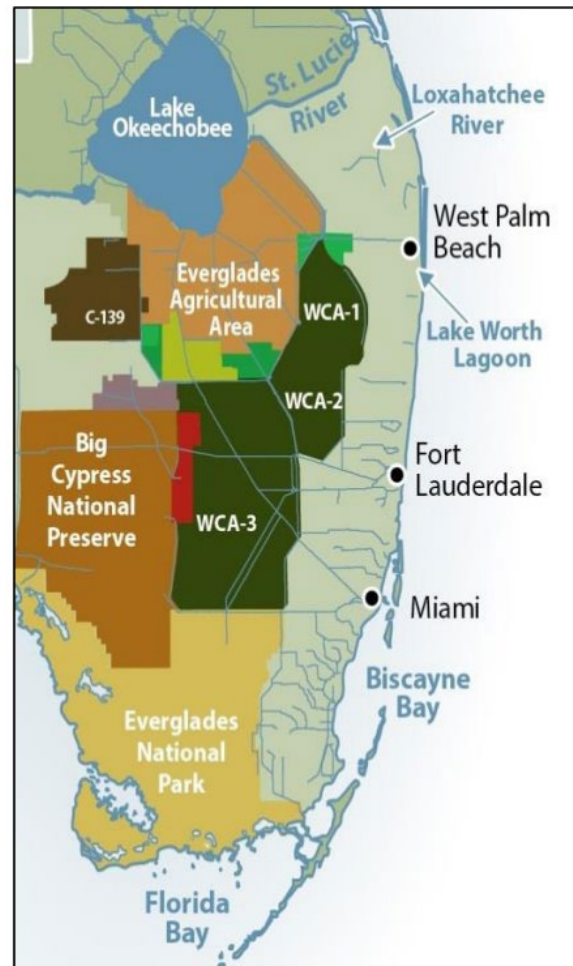

Figure 6-7: Water Conservation Areas

Phase 1 C-51 Reservoir Project

This alternative water supply project, a public-private partnership between utilities and the mining industry, is designed to store excess water from the C-51 basin before being discharged to tide and conveying this water through canals during drier periods to areas adjacent to existing public supply wellfields. The project construction is estimated at \$161 million, is expected to hold 14,000 acre-feet of static storage, and deliver 35 MGD in the alternative water supply to offset impacts on regional canals from allocation increases. The reservoir is expected to be fully constructed in 2023.

Town of Jupiter Groundwater Recharge System

This water storage and recharge project captures excess freshwater from the C-18 canal and conveys it through a system of existing control structures, flow-ways and salinity barriers within the Town to

increase surface water storage and surficial aquifer recharge utilizing freshwater normally discharged to tide through the S-46 structure. The Town has invested over \$3,000,000 in infrastructure (ditches, pump stations, conveyance systems, control structures) in the surface water recharge system in collaboration with the SFWMD.

Role of Coastal Structures in Protecting Water Supply Sources

As detailed earlier in this document, this resiliency plan seeks to build resiliency and mitigate the risks of flooding and sea level rise on water resources. The District's canals and coastal structures are an integral part of water resources management. Among other purposes, the coastal structures act as barriers preventing saltwater intrusion from moving inland and impacting wellfield protection zones and other environmentally protected areas. They do this by maintaining freshwater elevations upstream of the structure higher than ocean/saltwater levels, especially during the dry season, and provide recharge to the Surficial/Biscayne Aquifer.

The canals operate under normal and dry/wet season conditions, which set the necessary water stages in the canal and, therefore, the subsequent operations of the canal's structures. These operational conditions are relative to and therefore limited by the difference in elevation between the head and tail waters. Upstream (freshwater) operating levels are less than one foot higher than downstream tidal stages at certain coastal structure locations during high tide events. The Biscayne Aquifer MFL Prevention Strategy established that 2 feet of freshwater head needs to be maintained for more than 6 months a year to prevent saltwater from encroaching into the Biscayne Aquifer. Figure 6-9 shows how often the S-29 structure's tailwater level dips below the 2 feet minimum, as well as how the tailwater and headwater are converging, which translates to less head difference in this gravity structure during extended periods of

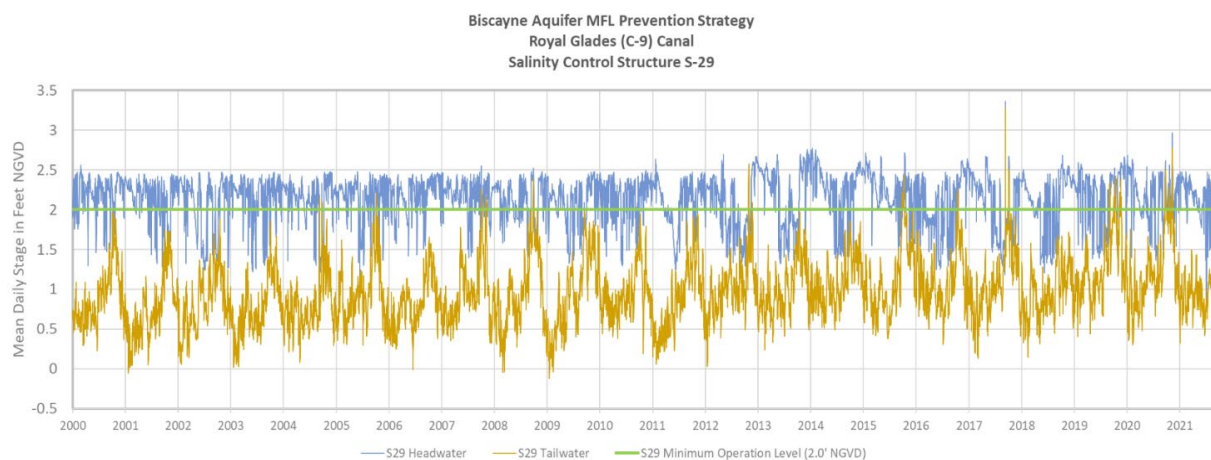

Figure 6-8: Headwater and Tailwater Stages at S-29 Structure

time (15). This reduced control is further exacerbated as the structures age, sea levels rise, and climate

and rainfall uncertainty increase, reducing the capability of the system to maintain freshwater minimum elevations and manage saltwater intrusion.

The rehabilitation and replacement of lift gates and the installation of a new pump station will allow, beyond flood protection, for increased control of upstream fresh water by giving operators flexibility in discharge capacity, precise flow rate control, and optimization via integrated basin-wide freshwater management, reducing unnecessary or earlier drawdowns as a result of the existing limitations in discharge capacity during higher tide events. The increased ability to maintain higher freshwater levels, especially during the dry season, significantly reduces the potential risk of saltwater intrusion affecting freshwater supplies. Additionally, the increased control will allow operators to adjust flows. As an example, Figure 6-10 shows the benefit to subregional groundwater water levels as the result of maintaining higher canal levels near the end of the wet season in Collier County.

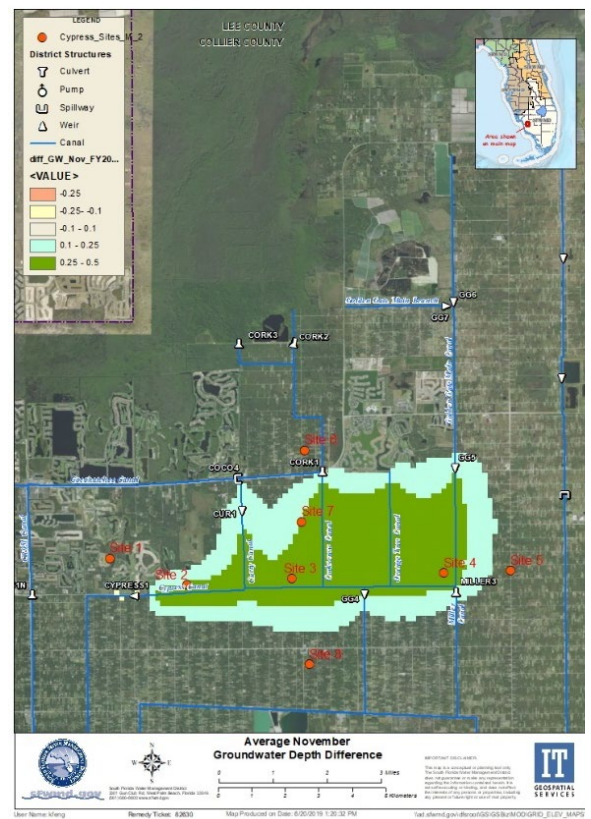

Figure 6-9: Average November Positive Groundwater Depth Difference Due to Optimized Structure Operations

In two basins where resiliency projects are currently being prioritized, risks to existing wellfield protection zones are observed by examining the advance of the saltwater interface. In the C-9 basin example, the risk to water supplies is particularly acute as the majority of North Miami’s water is serviced by the Norwood-Oeffler Water Treatment Plant. This 15 MGD plant’s freshwater wells are within one mile of the saltwater intrusion line and coastal structure. In the C-7 basin, the saltwater intrusion line is 7 city blocks away from the freshwater wells for the Winson Water Treatment Plant. Since 2009, the saltwater interface has gradually been moving westward (see Figure 6-11). Since 2000, 25 water supply wells have been lost along South Florida’s coastline due to saltwater intrusion.

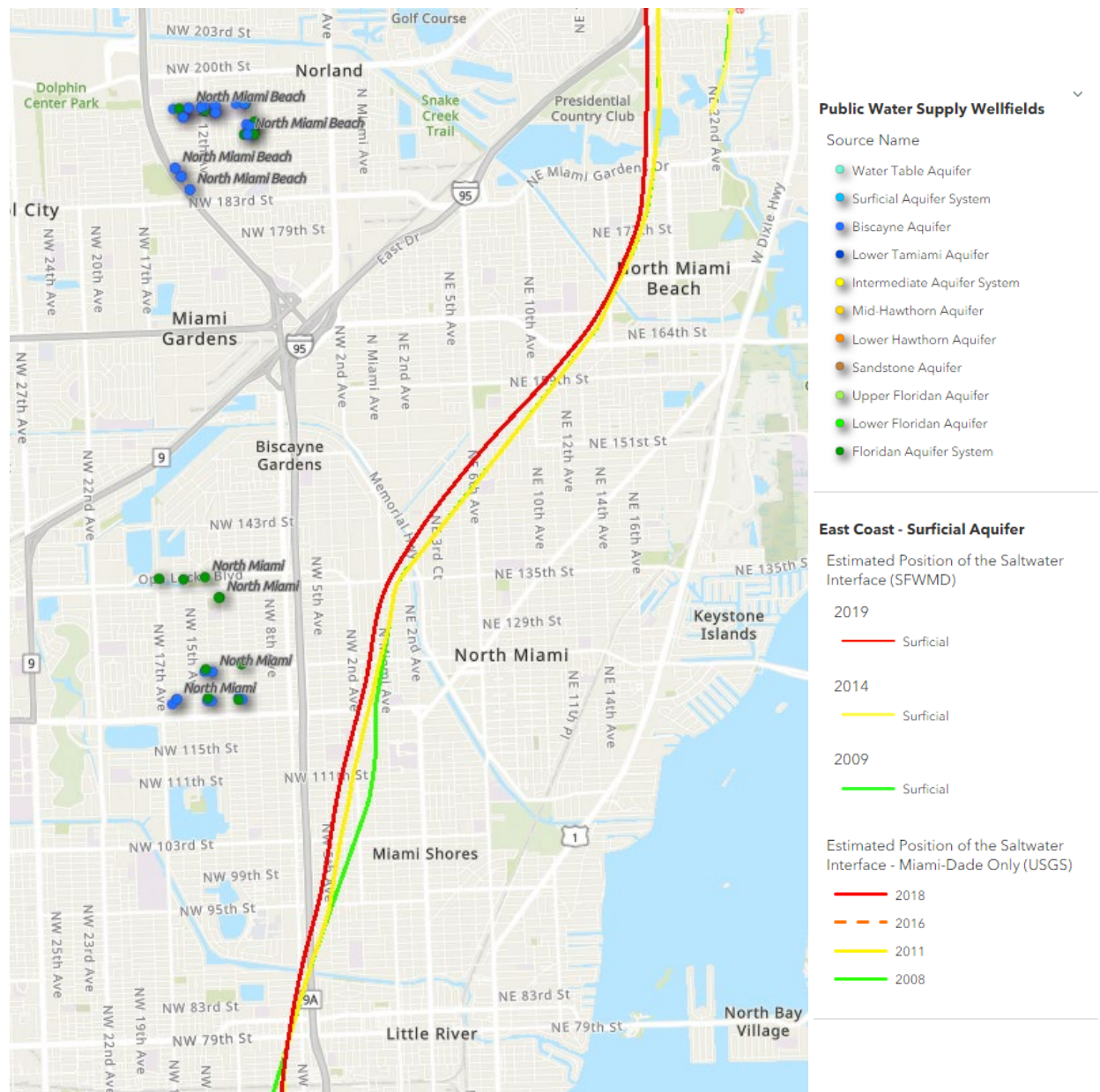

Figure 6-10: Saltwater Interface Line in S-27, S-28, and S-29 Structures.

*Detailed information on Water Supply Management and saltwater intrusion is documented in the Lower East Coast Water Supply Plan and Saltwater Interface Monitoring and Mapping Program Technical Publication WS-58.

Resiliency Path Forward

In addition to all the current projects being implemented or funded by the District and its partners, there will be a process for assessing and responding to the resiliency needs of water suppliers. These needs will be better understood through vulnerability assessments and robust data collection efforts already underway as part of the District's Water Supply Vulnerability Assessment project. The Water Supply Vulnerability Assessment project will help the District determine what the water supply needs are and will provide guidance on the execution of future resiliency projects like the ones featured throughout this plan. Additionally, this project will inform the integration of appropriate measures and criteria for water allocation and serve as a benchmark for evaluating the overall sustainability of the District's water resources. These projects and all additional data analysis and assessments related to the resiliency of water supplies will be documented as part of future iterations of the Resiliency Plan.

7: Energy Efficiency and Renewable Energy

Energy Efficiency

The South Florida Water Management District (District or SFWMD) is committed to improving the energy efficiency of operations and to offsetting new energy demands through renewable energy solutions. By following the latest building codes and using state-of-the-art materials and designs, the District builds efficient and resilient projects (Flood Resistant Design and Construction, American Society of Civil Engineers Standard 24).



Energy efficiency is crucial because it helps to reduce the District's overall energy consumption, which in turn might reduce the reliance on fossil fuels and other non-renewable sources of energy. By investing in energy-efficiency and renewable energy projects, the District can significantly reduce the amount of energy consumed and reduce the District's carbon footprint. Overall, a combination of renewable energy and energy efficiency measures is essential for a sustainable future.

The District is looking into using two programs as guidance to help improve energy efficiency and promote sustainable energy in facilities and projects. The Leadership in Energy and Environmental Design (LEED) certification program and the Envision program are sustainable building design and certification programs that may be helpful in designing and implementing projects. With regards to renewable energy, solar energy systems are already integrated into some of the District's projects, as detailed below.

Florida Building Code Requirements and Third-Party Programs

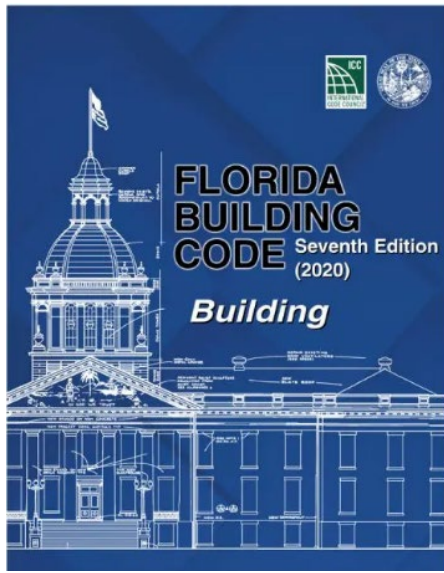

District project designs follow the [Florida Building Code](#). The Code requires many of the energy efficiency-related items that would be evaluated for projects seeking certification by third-party organizations such as LEED and Envision. Florida Building Code and recommendations from LEED and Envision are driving the District to develop and adopt energy-efficient approaches to features such as heating, cooling, lighting, and operations of motors and ancillary equipment. These state-of-the-art technologies will continue to be evaluated to improve the energy efficiency of District facilities.

LEED (Leadership in Energy and Environmental Design) is an ecology-oriented building certification program run by the U.S. Green Building Council (USGBC). LEED provides a framework for healthy, efficient, carbon and cost-saving green buildings. (“LEED Rating System” U.S. Green Building Council, <https://www.usgbc.org/leed>)

LEED-certified buildings save money, improve efficiency, lower carbon emissions, and create a healthier living environment. They are a critical part of addressing climate change and meeting Environmental, Social, and Governance goals, enhancing resilience, and supporting more equitable communities.

ACTIONS THAT THE DISTRICT TAKES TO HELP INCREASE ENERGY EFFICIENCY INCLUDE:

- Automation of pump stations – reduces resource use, less fuel and effort for maintenance.
- Design projects for longer life – less maintenance over the life of an asset.
- Reducing use of or size of control buildings - Most control buildings are concrete with low heat gain allowing all or most of the facility to function appropriately without air conditioning.
- Diversifying the District’s motor pool to include Electric Vehicles.
- Staggering the start of motors and other electrical equipment to reduce the maximum electrical service needed.

Include smaller “house loads” generator so that generators are sized appropriately for the different loads that are needed during pumping and non-pumping operations.

To achieve LEED certification, a project earns points by adhering to prerequisites and credits that address carbon, energy, water, waste, transportation, materials, health, and indoor environmental quality. Projects go through a verification and review process and are awarded points that correspond to a level of LEED certification: Certified (40-49 points), Silver (50-59 points), Gold (60-79 points), and Platinum (80+ points).

The goal of LEED is to create buildings that:

- Reduce contribution to global climate change.
- Enhance individual human health.
- Protect and restore water resources.
- Protect and enhance biodiversity and ecosystem services.
- Promote sustainable and regenerative material cycles.
- Enhance community quality of life.

Envision is another holistic sustainability framework and rating system run by the Institute for Sustainable Infrastructure that enables a thorough examination of the sustainability and resiliency of all types of civil infrastructure. It can be used to assist the District in delivering civil infrastructure that tackles climate change, addresses public health needs, cultivates environmental justice, creates jobs, and spurs economic recovery. (“Envision: The Blueprint for a Sustainable Future” Institute for Sustainable Infrastructure, <https://sustainableinfrastructure.org/envision/overview-of-envision/>)

Envision consists of:

- A guidance manual that includes 64 sustainability and resiliency criteria
- Project assessment tools
- Third-party project verification
- Professional training and credentialing

NET-METERING FOR SOLAR POWER SYSTEMS

- When a solar power system generates more electricity than the customer can use, the customer receives a credit for the excess kilowatt-hours (kWh) sent to the grid.
- If less electricity than needed is produced via solar, the customer must buy electricity from the utility to make up the difference.
- The customer pays for the “net” amount of electricity used (kWh purchased minus credit for kWh exported).
- It does this via a bidirectional electric meter that is installed along with the solar panels.

Renewable Solar Energy

Renewable energy sources are clean and emit little to no greenhouse gases that are responsible for climate change. This means that using renewable energy helps to reduce the District's carbon footprint and mitigate the impacts of climate change. Florida receives abundant sunshine throughout the year, which makes it an ideal location for solar power generation. Additionally, solar power can help to reduce energy costs over the long term as a renewable source of energy.

The District is currently using renewable solar energy solutions to power much of its environmental monitoring network and to assist in powering certain components of District facilities, such as lighting and gate operation. Solar panels take up a considerable amount of space, and large-demand projects are complex to implement in urban environments due to the lack of larger open space. However, the District owns 1.5 million acres of land, some of which are available and suitable for solar arrays.

The District is considering one pilot project to explore the use of floating solar panels in applications where wind damage to the solar infrastructure would not increase the risk to the flood control system. This proposed pilot project would be implemented on Lake Freddy at the District headquarters in West Palm Beach. In addition, a solar canopy for District fleet vehicles in the parking lot at headquarters is also being evaluated to address a portion of existing energy demands.

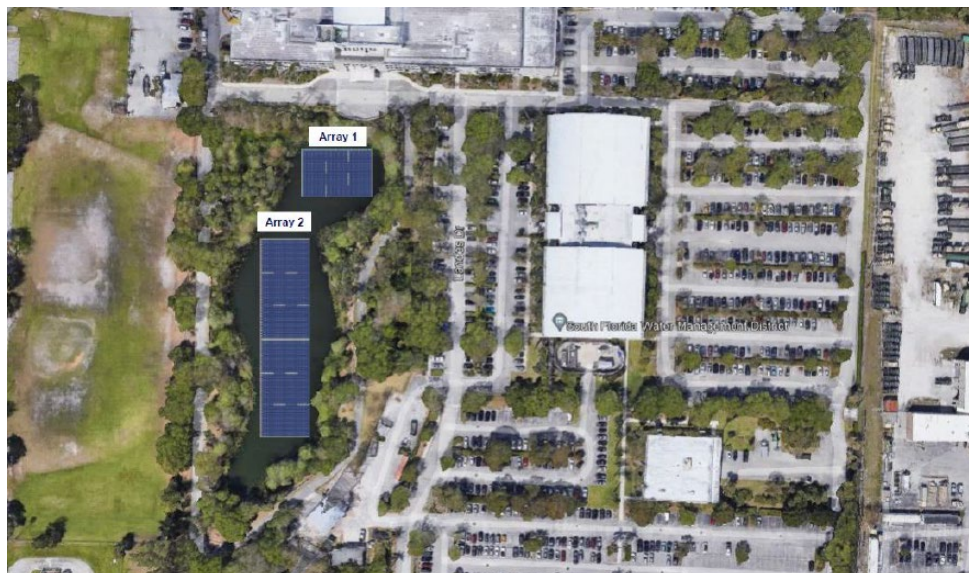

Figure 7-1: Lake Freddy Floating Solar Array Pilot Project.

In addressing larger energy needs, and with the goal of offsetting new energy demands, the District is assessing the possibility of implementing solar power for projects in areas where there is an abundance of open land for solar panels. Currently, the District is investigating opportunities with Florida Power and Light (FPL) to install solar arrays on District lands near the C-43 and C-44 Reservoir projects, with the

goals of reducing energy costs at these facilities, as well as offsetting carbon emissions from existing and new proposed structures that rely at least partially on fossil fuel generated power.

The District is also exploring the possibility of purchasing and installing solar arrays near specific project locations. These potential projects would use smaller (approximately 2 megawatts) arrays that would provide power directly to District facilities. These installations would be connected to the electrical grid and use net-metering to track solar power generation and consumption, as described below.

Solar Incentives

A big incentive for solar over the years has been the Federal Investment Tax Credit (ITC). This was a 30% dollar-for-dollar tax credit that taxable entities received. Unfortunately, in the past, non-taxable entities had no way of reaping this incentive. That changed with The Federal Inflation Reduction Act (IRA) of 2022, which now allows non-taxable entities to receive a 30% rebate on the total cost of solar installations.

In addition to the 30% ITC rebate, the IRA establishes three different types of ITC “Adders,” which provide additional tax credits of up to 10% each for projects that meet specified requirements (see below). These incentives would allow the District to receive a rebate of up to 40% on solar projects.

Low-income: Projects located in a qualified “low-income community,” which is defined as a census tract with a poverty rate of at least 20%, as well as a census tract where the median family income (MFI) is 80% or less of statewide MFI, or on “Indian land,” which is defined as land located within the boundaries of an Indian reservation or lands held by a tribe.

Domestic Content: for projects that meet specified domestic content requirements, which will be set by Treasury, including 100% steel/iron for manufactured products with a 40% requirement through 2024. Manufactured content will be deemed to have been produced in the United States if the adjusted percentage of the total costs of all such manufactured products of the facility are attributable to manufactured products that are mined, produced, or manufactured in the United States.

The District is currently further investigating these opportunities to determine how these initially proposed projects might benefit from the 2022 IRA rebate programs.

8: Characterizing and Ranking Resiliency Projects

Introduction

The South Florida Water Management District (District or SFWMD) is initially focusing its resiliency infrastructure investment priorities to address coastal water control structure's vulnerability to sea level rise. This is a no-regret strategy (these structures would need to be altered under any future scenario), as recommended by the District's Flood Protection Level of Service (FPLOS) Phase I Flood Vulnerability Assessments and validated by FPLOS Phase II Adaptation Planning Studies. The results of these FPLOS studies demonstrate current limitations on the operational capacity of and the need for adaptation to restore original design capacities at these structures.

During the initial stages of already observed sea level rise impacts, the District is continuing to operate structures through operational changes by investing in extending the top of gates and implementing



Figure 8-1: Central & Southern Florida Project

targeted structure enhancement measures. As sea levels increase, additional measures will be required to maintain headwater stages at structures and to prevent saltwater intrusion and flooding impacts. Enhancing existing structures can substantially improve their functionality and performance by reducing the vulnerability of systems and equipment to flooding and maintaining their ability to protect against saltwater intrusion.

Adaptation to sea level rise and storm surge involves large-scale projects that integrate floodwalls, gates, and forward pumps to properly manage surface and groundwater within the area. In addition, long-term sea level rise may also involve seepage barriers to avoid saltwater intrusion and control the long-term rise in groundwater levels. Some of these efforts are beginning to be advanced in the region to address storm surges and other coastal hazards.

Many of the District's coastal structures were constructed over 70 years ago and are no longer

capable of conveying their design discharge due to changes within the watershed, sea level rise, and climate change. The District is proposing to restore the original design discharge at these structures by installing forward pump stations that can continue to discharge to tide when gravity discharge ceases (during storm surge or extreme high tide events) and to augment gravity discharge at critical times. These improvements will be made in increments until the original design capacity is fully restored. Figure 8-1 below illustrates the relative percent of the time that gate closures were needed during the King Tide season (September through November) in 2020 at four different locations. As observed in these charts, these gates were closed for about 3-5 hours on average per day during King Tide events, with a significant increase of up to 15 hours per day during the peak of the 2020 King Tide season.

To determine pumping capacity needs at the coastal structures, pump sizes at the most immediate priority structures have been initially estimated using one-half of the design discharge capacity of the structure. For instance, a structure with a design discharge capacity of 1,000 cubic feet per second (cfs) would need a 500 cfs pump station. Structures ranked as intermediate in terms of priority are being augmented with one-quarter of the design discharge capacity for initial pump sizing. Structures ranked in the long-term need category would not have pump cost estimates until they move from long-term to intermediate need. Initial pump sizing is based on a) existing Central & Southern Florida (C&SF) forward pump implementation strategies; b) the assumption that other local flood mitigation strategies will be constructed in the basin in combination with the local forward pump solutions; c) the consideration of downstream capacity; and d) best professional judgment.

The C-8/C-9 Basin FPLOS Phase II Adaptation Planning Study has recently recommended more specific pump capacities for S-28 and S-29 Coastal Structures, as detailed in Chapter 9. As the design is evolving for these and other coastal structures, final pump capacities will be determined. Figures 8-2 and 8-3 below illustrate a comparison between the amount of time needed to remove the cumulative flows (or the total runoff to bring the stages back to normal operating ranges) for the scenarios with forward pumps sized at 25% and 50% of the spillway design capacity, relative to the no pump scenario. The design of forward pump stations will be adaptable and will include the ability to add additional pumps in the future as environmental conditions change. The precise nature of improvements at each structure, including consideration of replacement needs, additional flooding barriers, and forward pump sizing, will be determined during the feasibility and design phases for each structure and as part of the more detailed and comprehensive FPLOS adaptation planning, Phase II Studies, which includes the assessment of local and larger regional forward pump strategies. No harm to downstream conveyance capacity or increasing flooding risks will result from the proposed forward pumping projects. Appropriate operational criteria

and mitigation measures will be planned and designed, as adequate, during the final feasibility and implementation phases.

The effectiveness of using forward pumps to reduce flood risk and restore the original level of service can be demonstrated by the operational results of existing forward pumps at the S-25B and S-26 coastal structures. During Hurricane Isaias, between July 20 and August 2, 2020, the average daily upstream water levels (headwater) were lowered consistently at structures with gravity flow and a forward pump. At the S-25B and S-26 coastal structures, upstream water levels were reduced significantly with the combination of gravity flow and forward pumping. During the same storm event at S-27, S-28, and S-29, the average daily upstream water levels increased with gravity flow alone. These observations, as illustrated in Figure 8-4, demonstrate the existing limitations and associated challenges in maintaining or reducing upstream water levels by relying solely upon gravity flow.

Another flood mitigation alternative is the utilization of emergency storage options. One example is the C-4 Emergency Detention Basin (C-4 EDB) in Miami-Dade County. When the C-4 Canal can't handle the water volume necessary to prevent flooding, the C-4 EDB is employed to receive and store the excess water. The forward pump station at the mouth of the C-4 Canal is the first component of the C-4 EDB that is used, when needed, in addition to gravity flow. The S-26 Pump Station at the mouth of the Miami River Canal in the C-6 basin was built to ensure the higher tailwater resulting from pumping at the S-25B does not impact C-6 upstream of S-26. These stations pump to the Miami River and are used first for flood control. The EDB is used for larger rain events when stages continue to rise and additional flood mitigation is needed. The C-4 EDB provides improved flood protection for the City of Sweetwater, Miami-Dade County, the City of Miami, and the City of West Miami.

Levee and canal bank enhancements are other examples of project recommendations included in this plan to provide additional flood protection and prevent the impacts of sea level rise on water resources and the environment. Enhancement of L-31 and the Corbett Levee are being proposed to address vulnerability to sea level rise, storm surge, and increasing stormwater volumes as a result of more extreme rainfall events. Future modeling efforts will determine additional resiliency needs at other levee structures.

All the proposed projects include resiliency strategies to reduce the vulnerability of communities and environmentally sensitive areas downstream and upstream of these structures.

The District is also committed to seeking green or nature-based solutions in addition to gray infrastructure improvements to increase resiliency, as described in Chapter 4. Gray infrastructure examples and green features will be necessary to meet the challenges of land development and climate change impacts,

including sea level rise, along with basin-wide solutions to maximize the capacity of flood adaptation. The restoration of design discharge capacities will need to be combined with additional upstream and downstream solutions to move forward as part of the FPLOS Phase II dynamic adaptive pathway approach. This approach and additional considerations were applied in the Pilot Phase II FPLOS Assessment for the C-7 Basin: Identification and Mitigation of Sea Level Rise Impacts (2015 FEMA PDM Study). The main objective of this study was to reduce the potential for loss of life and property by recommending alternative mitigation strategies to be updated in the Miami-Dade County Local Mitigation Strategy (LMS). The project had two elements: 1) a technical assessment of the FPLOS for the existing infrastructure under current and future sea level rise scenarios, and 2) a strategic assessment of alternative mitigation strategies intended for incorporation into the Miami-Dade LMS. The study evaluated a series of mitigation alternatives for the basin involving local hydraulic measures (M1), a regional forward pump (M2), and elevating buildings (M3) and associated benefits to be implemented by multiple agencies. The results show various pathways (sequences and combinations of mitigation strategies) that can be explored to facilitate the implementation of different alternatives. Once an individual flood mitigation alternative is

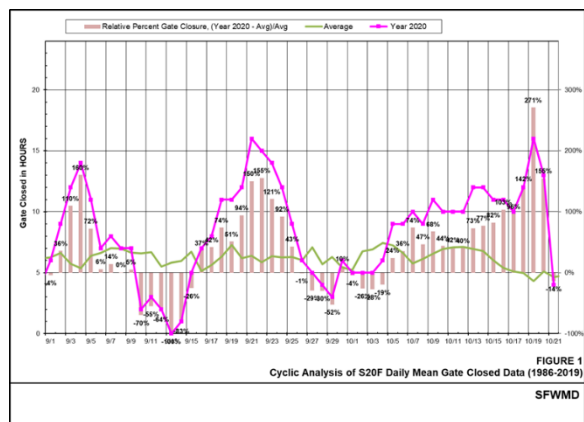
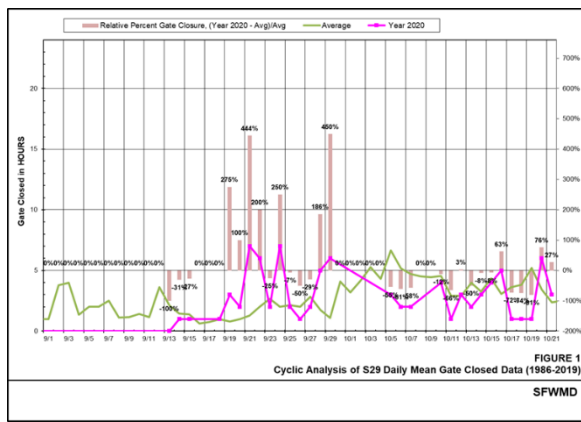
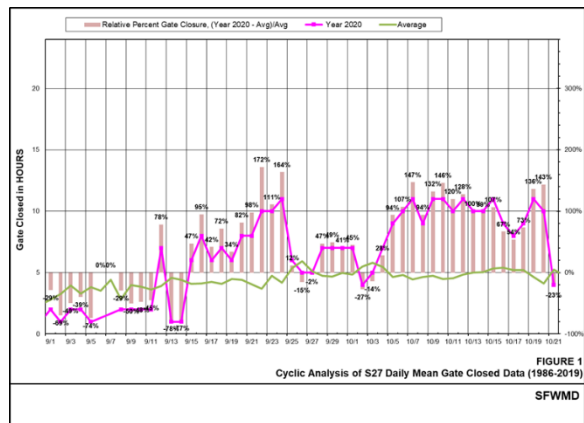
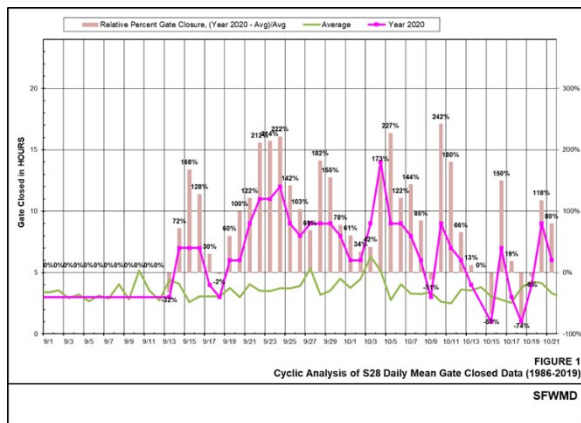
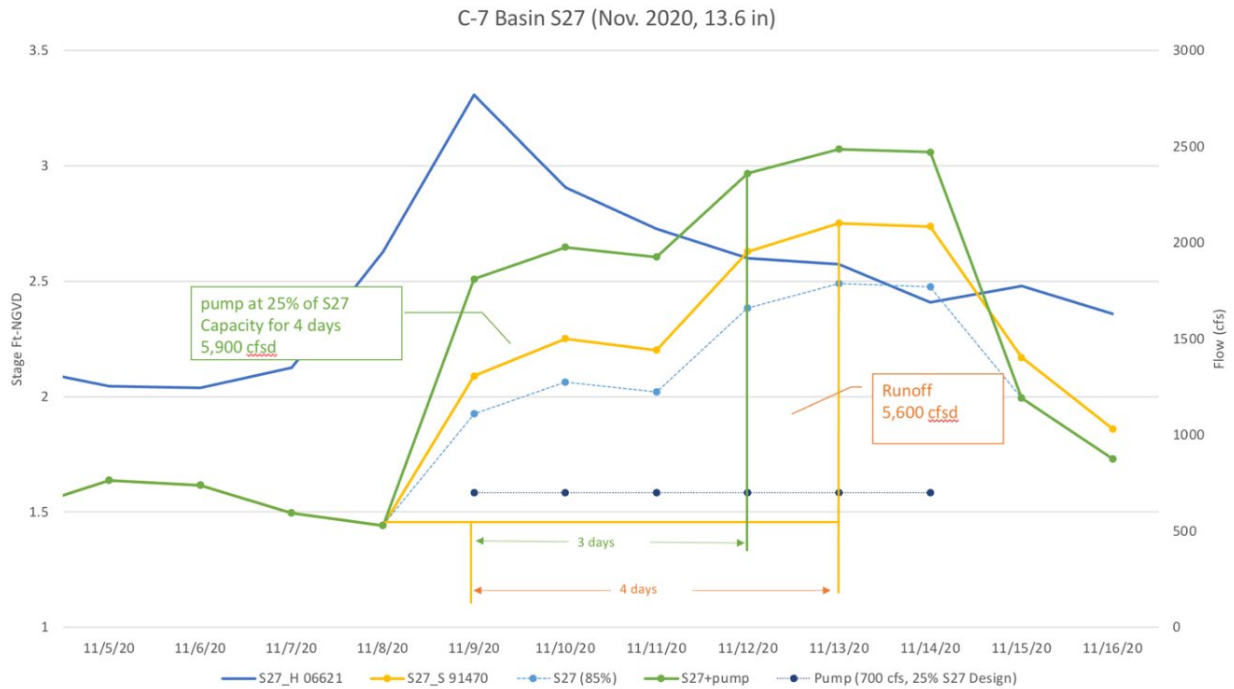

Figure 8-2: Relative Percent Gate Closure Times during the 2020 High Tide Season.

no longer able to achieve the specified target of the performance, additional or other mitigation strategies are presented. Adaptation pathways were assessed for the entire C-7 Basin, as summarized in Figure 8-5 below, showing how multiple strategies can be combined over time along different implementation pathways. A similar strategy was recently finalized as part of the C-8/C-9 Basins FPLOS Phase II Adaptation Planning Studies (16).



Potential amount of time needed to remove the cumulative flows at S-27 (5,600 cfs/day total runoff to bring the stages back to normal operating ranges during Tropical Storm Eta in November 2020) for the scenario with forward pumps sized at 25% of the spillway design capacity (3 days) relative to the no pump scenario (4 days).

Figure 8-3: Potential amount of time need to remove cumulative flows at S-27.

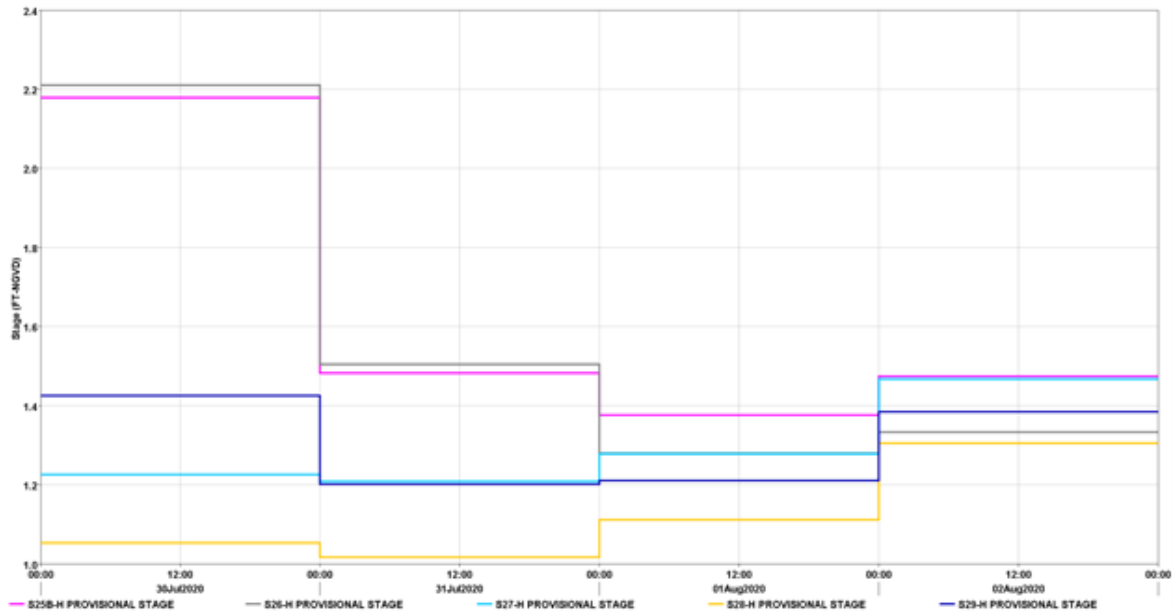

Figure 8-4. Observed Headwater Stages during Hurricane Isaias at Coastal Structures with forward pumps (S-25B and S-26) vs. Coastal Structures with gravity discharge only (S-27, S-28, S-29).

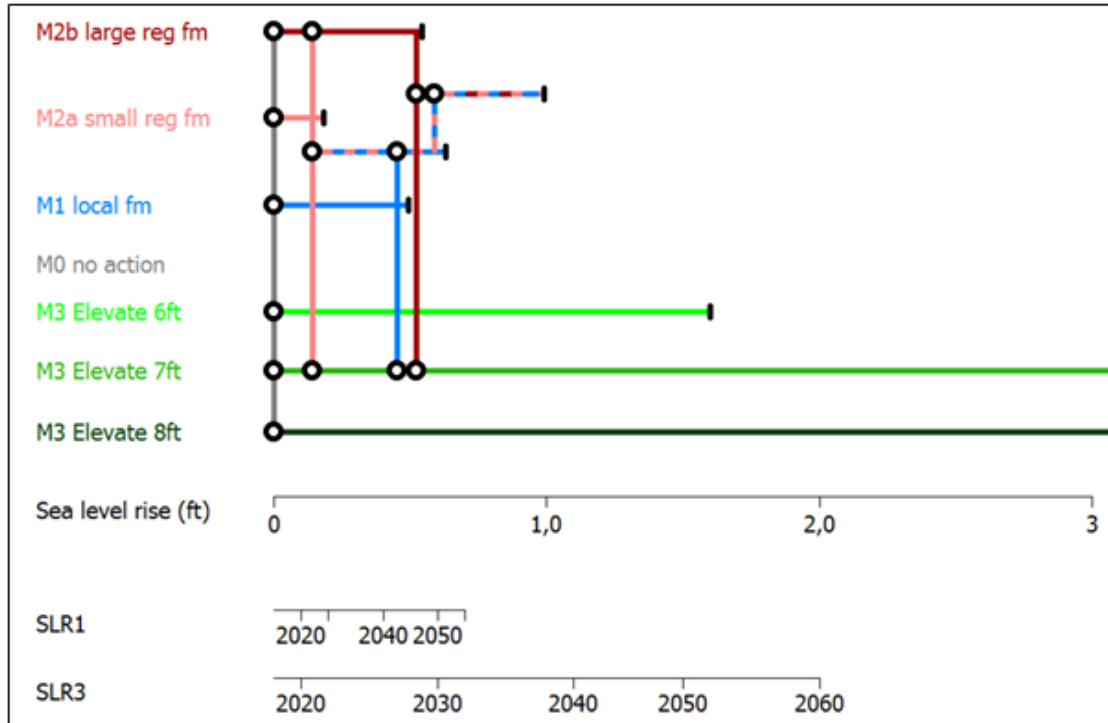

Figure 8-4: Illustrative Adaptation Pathways map for the C-7 Basin.

Updated Federal Emergency Management Agency Coastal Zone A Maps, the U.S. Army Corps of Engineers (USACE) South Atlantic Coastal Study and Back Bay Feasibility Studies, including the Miami-Dade, Collier County, and the Florida Keys (Monroe County) Coastal Storm Risk Management Studies were recently released in response to coastal storm risks and flood protection needs. These studies were developed focusing on storm surge flood inundation risks. The District is working closely with these Federal Agencies to coordinate the implementation of coastal adaptation strategies such as beach and dune restoration, shoreline stabilization, flood walls, and nature and natural base solutions, including living shorelines, oyster and coral reefs, marshes, etc., along with the ongoing Section 216 C&SF Flood Resiliency Study. **Error! Reference source not found.**8-6 below summarizes how these combinations of solutions can be developed through cooperation among local, state, regional, and Federal Agencies. The figure is meant to highlight many of the mitigation strategies that are available for use either by themselves or together when the site allows. Figure 8-7 describes the Illustrative Adaptation Pathways map for the C-7 Basin based on the simulated expected annual damage for the current sea level and the two possible future sea level rise scenarios. Each alternative has a horizontal line representing its effectiveness as sea level rise increases over time. Circles represent decision points, beginning with the selection of which alternative to start implementation (along the vertical gray line). New alternatives are available (new vertical lines) as a new decision point (circle representing a performance threshold) is reached along the horizontal implementation pathways. Figure 8-8 (Source: USACE, modeled from https://ewn.el.ercd.dren.mil/nmbf/other/5-ERDC-NNBF_Brochure.pdf) describes the potential flood mitigation measures to improve resiliency and sustainability.

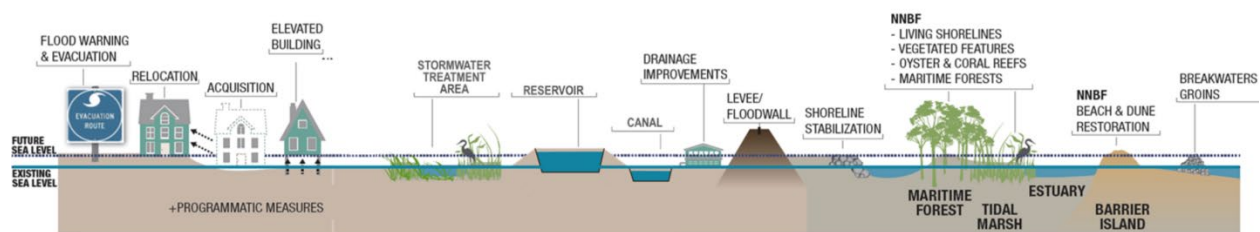

Figure 8-5: Potential Flood Mitigation Measures to improve resilience and sustainability.

Socially Disadvantaged Communities

The District serves diverse communities throughout its area of operations, each experiencing unique and varied impacts resulting from climate change and other changing conditions, including population increase and land development. The timing, extent, and kinds of these impacts vary depending on factors like location, such as coastal or inland, and socioeconomic circumstances. The SFWMD considers the disproportionate vulnerability of minority and financially disadvantaged communities who are more adversely affected by the impacts of climate change as part of its resiliency planning efforts to ensure

equitable community-wide benefits. Ensuring equitable community-wide benefits means providing equal protection from adverse impacts, equitable access to the benefits provided by resiliency projects, and equal opportunity for participation in the planning and decision-making processes for all affected communities.

To effectively plan resiliency projects to meet the mission and resiliency vision and serve South Florida communities, the District has adopted a set of guiding principles that steer social considerations. These guiding principles ensure that resiliency projects provide an equal degree of protection against climate change-driven environmental impacts, promote an enhanced quality of life for all members of the communities residing within the project basins, and offer equal access to the planning and decision-making processes through stakeholder engagement and coordination with the local governments and

SFWMD's Resiliency Planning Guiding Principles for Social Considerations:

- **Do no harm** – SFWMD resiliency projects are designed to avoid further harm to vulnerable communities.
- **Prioritize and value prevention** – SFWMD focuses on preparing South Florida communities for anticipated changing conditions, ensuring the water management systems can withstand natural hazards and recover quickly from disruptions.
- **Prioritize vulnerable communities** – SFWMD prioritizes investments in projects that benefit disadvantaged communities and enhances the quality of life for all community members.
- **Meaningful community engagement** – SFWMD actively seeks input and ideas from community members, ensuring projects are informed by their perspectives. Transparency is key in developing and executing resiliency work to foster ongoing engagement, communication, trust, and collaboration.
- **Proactive engagement and leadership** – SFWMD involves community experts and leaders

impacted communities.

The SFWMD utilizes a range of resources to determine social vulnerability, identify disadvantaged communities, and highlight locations that may be candidates for further review both at a regional scale and within project impact areas. These data are included in project ranking criteria and grant applications. The District relies on reputable sources, including the Center for Disease Control (CDC) Agency for Toxic Substances and Disease Registry (ATSDR) Social Vulnerability Index (SVI), the Council on

Environmental Quality (CEQ), Climate and Economic Justice Screening Tool (CEJST), the Environmental Protection Agency (EPA) Environmental Justice screening and mapping tool (EJScreen), and the Federal Emergency Management Agency (FEMA) National Risk Index (NRI).

These resources are driven by diverse federal datasets and consider socioeconomic status either in isolation or in conjunction with various other factors like access to resources, environmental quality, and exposure to natural hazards, as outlined in tables 8-1 through 8-4. By utilizing these robust datasets, a more comprehensive understanding of the intricate relationship between the socioeconomic status of communities, their environment, and the risks they confront can be gained. Figures 8-7 through 8-10 show the areas where vulnerable and disadvantaged communities were identified within the SFWMD region.

Incorporating these socioeconomic, environmental, and risk indicators as part of the project ranking process ensures regional support to local communities, facilitating the identification and implementation of solutions that alleviate environmental impacts, increase resilience to hazards, and increase the quality of life, where it is most needed. The prioritized resiliency projects are expected to result in reduced flood risks, increased resilience of water supply systems, preservation and enhancement of natural areas, heightened civic engagement, and improved quality of life for all residents of these communities.

Centers for Disease Control/Agency for Toxic Substances and Disease Registry Social Vulnerability Index

The CDC's Agency for Toxic Substances and Disease Registry (ATSDR) Social Vulnerability Index (SVI) utilizes U.S. Census data to assess the social vulnerability of communities in each census tract. Census tracts are geographical subdivisions within counties where statistical data is collected by the Census. The CDC/ATSDR SVI evaluates each tract based on 16 social factors, which are grouped into four themes (Table 8-1). Each tract receives a separate ranking for each of the four themes and an overall ranking. The ranking scale ranges from Very Low (0.0-0.19) to Low (0.20-0.39), Moderate (0.40-0.59), High (0.60-0.79), and Very High (0.8-1.0).

The SFWMD uses the overall SVI ranking equal to or greater than the intermediate range to identify socially vulnerable communities both at the regional level (as depicted in figure 8-7) and within project impact areas. Figure 8-7 highlights the locations where socially vulnerable communities have been identified within the SFWMD region.

Table 8-1: CDC/ATSDR SVI Themes and Corresponding Social Factors

Socioeconomic Status	Household Characteristics	Racial and Ethnic Minority Status	Housing Type & Transportation
<ul style="list-style-type: none"> • below 150% poverty • unemployed • housing cost burden • no high school diploma • no health insurance 	<ul style="list-style-type: none"> • aged 65 or older • aged 17 or younger • civilian with a disability • single-parent households • English language proficiency 	<ul style="list-style-type: none"> • Hispanic or Latino (of any race), Black and African American (not Hispanic or Latino), American Indian and Alaska Native (not Hispanic or Latino), Asian (not Hispanic or Latino), Native Hawaiian and Other Pacific Islander (not Hispanic or Latino), Two or More Races (not Hispanic or Latino), Other Races (not Hispanic or Latino) 	<ul style="list-style-type: none"> • multi-unit structures • mobile homes • crowding • no vehicle • group quarters

*Source: CDC/ATSDR Social Vulnerability Index (SVI).

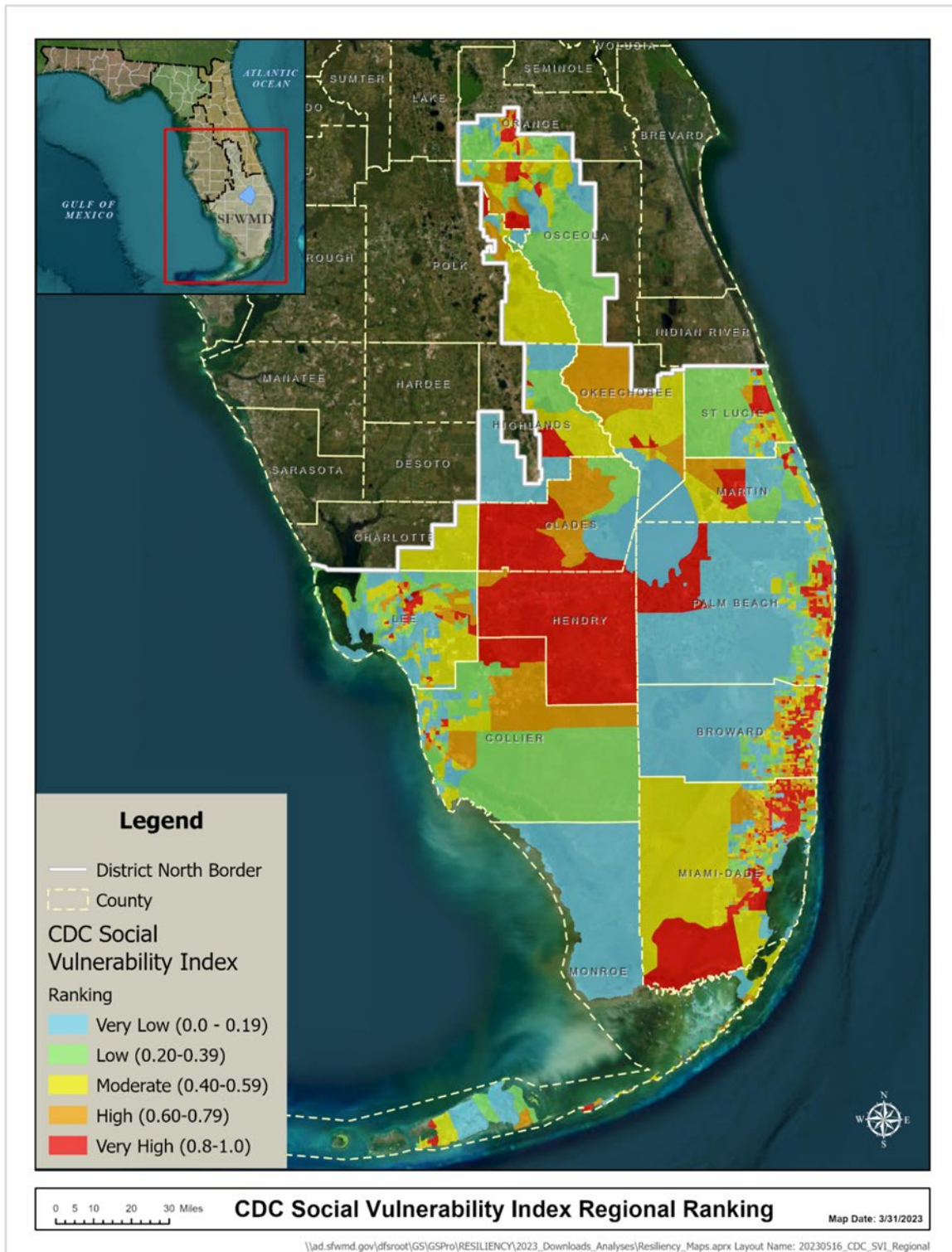

Figure 8-6: Communities identified as socially vulnerable based on the CDC/ATSDR SVI overall ranking for census tracts within the SFWMID region.

CEQ CEJST

The Council on Environmental Quality's (CEQ) Climate and Economic Justice Screening Tool (CEJST) utilizes various data sources to identify disadvantaged communities with consideration for environmental quality, including:

- U.S. Census's American Community Survey, the Federal Emergency Management Agency's (FEMA) National Risk Index,
- First Street Foundation's Climate Risk Data,
- Department of Energy (DOE)'s Low-Income Energy Affordability Data (LEAD) Tool,
- Environmental Protection Agency's (EPA) Office of Air and Radiation (OAR) Environmental Justice Screening and Mapping Tool (EJScreen),
- Centers for Disease Control and Prevention's (CDC) PLACES and U.S. Small-area Life Expectancy Estimates Project (USALEEP) data,
- National Community Reinvestment Coalition's (NCRC) dataset of formerly redlined areas,
- Department of Housing and Urban Development's (HUD) Comprehensive Housing Affordability Strategy (CHAD),
- Multi-Resolution Land Characteristics (MRLC) consortium by the Trust for Public Lands and American Forests' Percent Developed Imperviousness (CONUS) data,
- Department of the Interior's (DOI) Abandoned Mine Land Inventory System (e-AMLIS),
- U.S. Army Corps of Engineers' Formerly Used Defense Sites data,
- EPA's Resource Conservation and Recovery Act (RCRA) database for Treatment, Storage, and Disposal Facilities (TSDF) data compiled by EJScreen,
- EPA's Comprehensive Environmental Response, Compensation, and Liability Information System (CERCLIS) database compiled by EJScreen,
- EPA's Risk Management Plan (RMP) facilities data compiled by EJScreen,
- EPA's National Air Toxics Assessment (NATA),
- Department of Transportation's (DOT) transportation access disadvantage data and traffic data compiled by EJScreen,
- EPA's Underground Storage Tanks (USTs) data,
- EPA's Risk-Screening Environmental Indicators (RSEI) compiled by EJScreen, and
- Bureau of Indian Affairs' (BIA) Land Area Representation (LAR) dataset.

The CEJST uses these data as indicators of burdens and organizes them into eight categories. The eight categories are climate change, energy, health, housing, legacy pollution, transportation, water and

wastewater, and workforce development (table 8-2). A community is identified as disadvantaged in the CEJST if it meets two criteria: (1) the census tract is at or above the threshold for one or more environmental, climate, or other burdens, and (2) the census tract is at or above the threshold for an associated socioeconomic burden. Additionally, a census tract surrounded by disadvantaged communities and with a low-income percentile at or above 50% is also considered disadvantaged.

SFWMD utilizes these eight categories to identify disadvantaged communities both at the regional level (as depicted in figures 8-8 and 8-9) and within project impact areas. Figures 8-8 and 8-9 illustrate communities identified as disadvantaged in the eight categories within the SFWMD region.

Table 8-2: The CEQ CEJST categories and corresponding factors.

Climate Change	Energy	Health	Housing
<p>ARE (1) at or above the 90th percentile for expected agriculture loss rate OR expected building loss rate OR expected population loss rate OR projected flood risk OR projected wildfire risk</p> <p>AND (2) are at or above the 65th percentile for low income</p>	<p>ARE (1) at or above the 90th percentile for energy cost OR PM2.5 in the air</p> <p>AND (2) are at or above the 65th percentile for low income</p>	<p>ARE (1) at or above the 90th percentile for asthma OR diabetes OR heart disease OR low life expectancy</p> <p>AND (2) are at or above the 65th percentile for low income</p>	<p>(1) Experienced historic underinvestment OR are at or above the 90th percentile for housing cost OR lack of green space OR lack of indoor plumbing OR lead paint</p> <p>AND (2) are at or above the 65th percentile for low income</p>
Legacy pollution	Transportation	Water and wastewater	Workforce Development
<p>(1) Have at least one abandoned mine land OR Formerly Used Defense Sites OR are at or above the 90th percentile for proximity to hazardous waste facilities OR proximity to Superfund sites (National Priorities List (NPL)) OR proximity to Risk Management Plan (RMP) facilities</p> <p>AND (2) are at or above the 65th percentile for low income</p>	<p>ARE (1) at or above the 90th percentile for diesel particulate matter exposure OR transportation barriers OR traffic proximity and volume</p> <p>AND (2) are at or above the 65th percentile for low income</p>	<p>ARE (1) at or above the 90th percentile for underground storage tanks and releases OR wastewater discharge</p> <p>AND (2) are at or above the 65th percentile for low income</p>	<p>ARE (1) at or above the 90th percentile for linguistic isolation OR low median income OR poverty OR unemployment</p> <p>AND (2) fewer than 10% of people ages 25 or older have a high school education (i.e., graduated with a high school diploma)</p>

*Source: [Methodology & data - Climate & Economic Justice Screening Tool \(geoplatform.gov\)](https://geoplatform.gov).

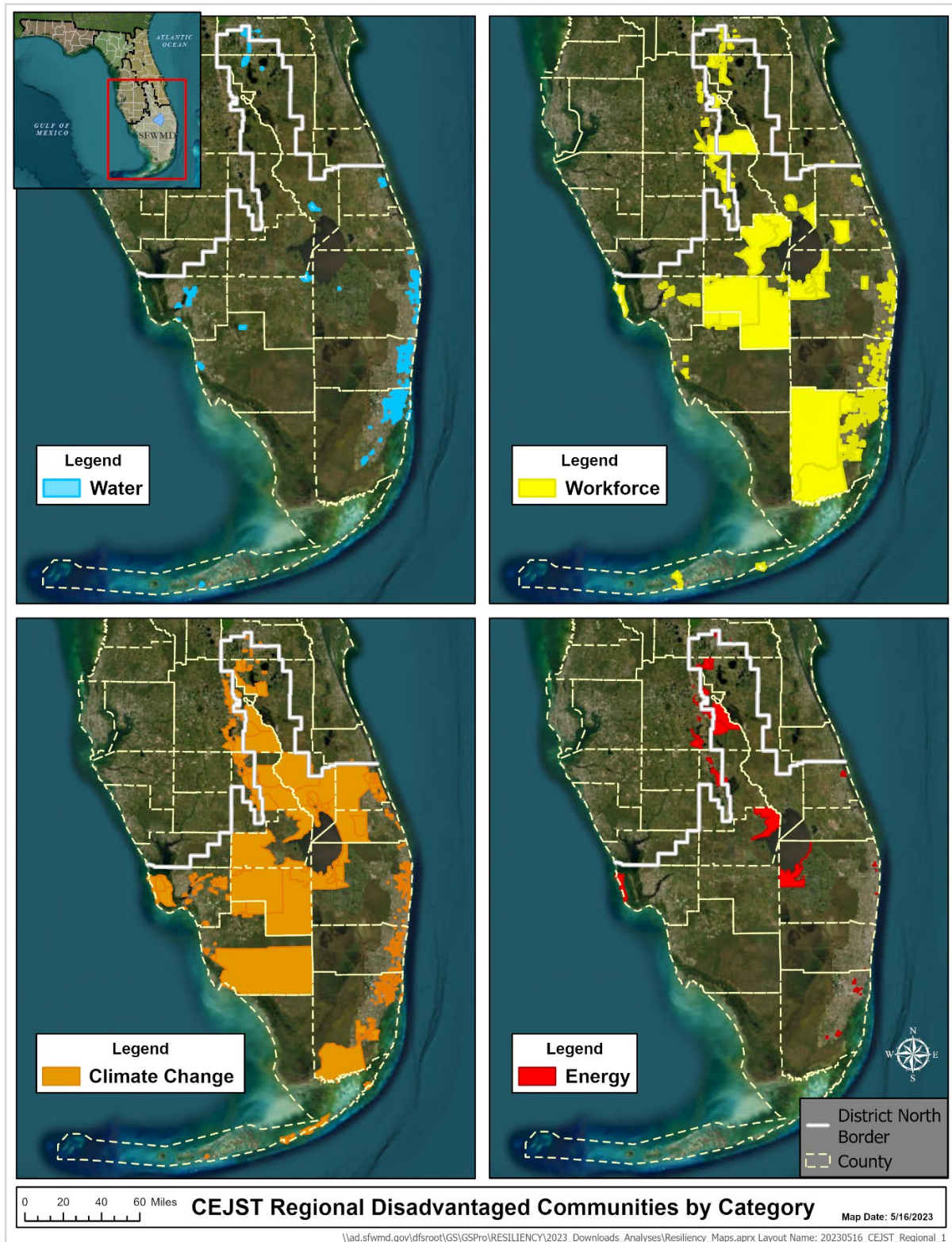

Figure 8-7: Communities identified as disadvantaged based on the CEQ CEJST for the water and wastewater, climate change, workforce, and energy burden categories.

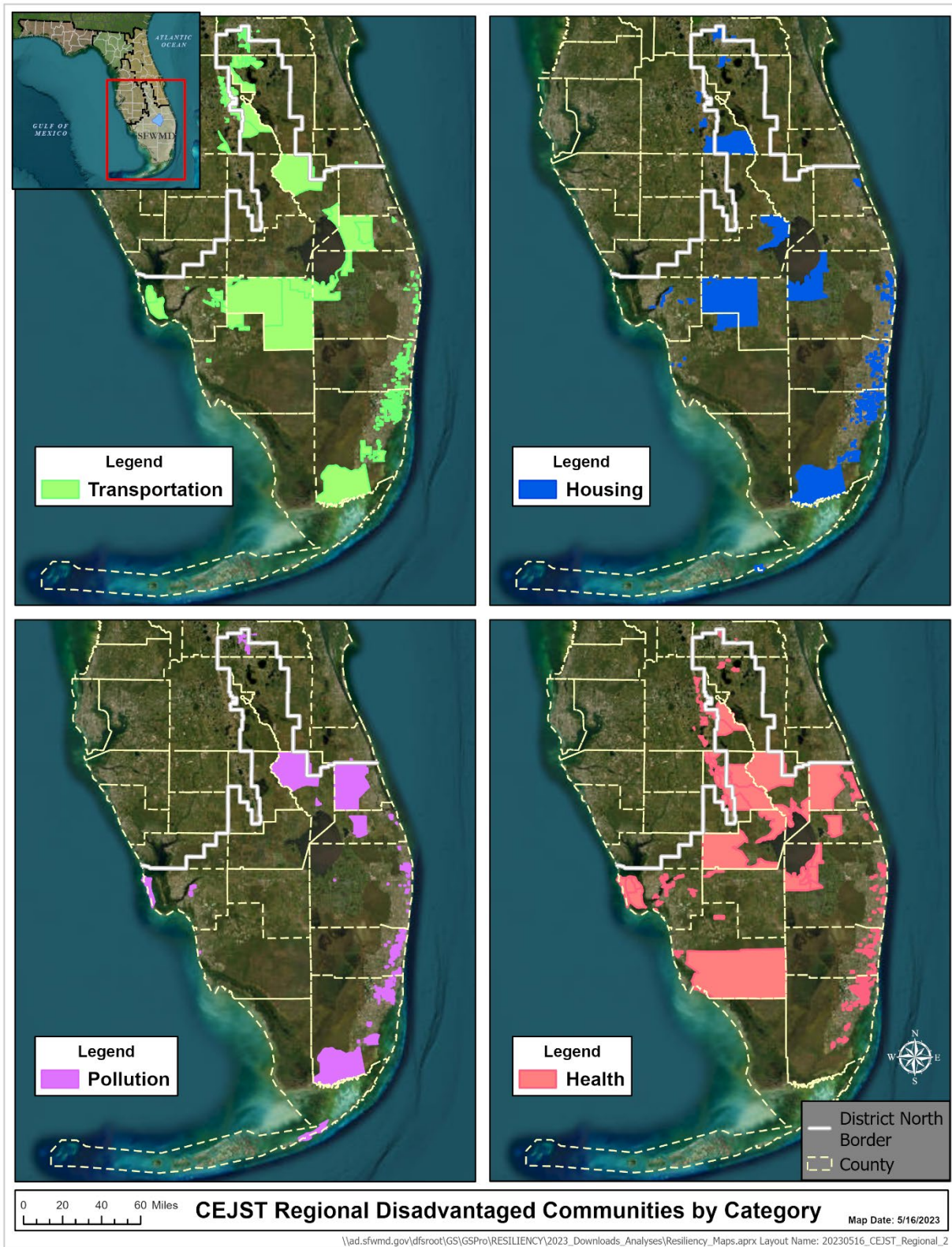

Figure 8-8: Communities identified as disadvantaged based on the CEQ CEJST for the transportation, housing, pollution, and health burden categories.

EPA EJScreen

The Environmental Protection Agency (EPA) Environmental Justice screening and mapping tool (EJScreen) conducts a preliminary assessment of communities most affected by environmental harms and risks in a selected location. EJScreen incorporates data from various sources, including:

- EPA, Office of Air and Radiation (OAR) Fusion of Model and Monitor Data
- EPA, Office of Air Quality Planning and Standards, Air and Toxics Data Update
- U.S. Department of Transportation traffic data
- U.S. Census's American Community Survey
 - Comprehensive Environmental Response, Compensation, and Liability Information System (CERCLIS) database, National Priorities List, and Superfund Alternative Approach sites
- EPA, Risk Management Plan (RMP) database, facility data
- EPA, Resource Conservation and Recovery Act (RCRA) database (RCRAInf)
 - EPA, Risk-Screening Environmental Indicators (RSEI) Model, Toxics Release Inventory (TRI) data

These data serve as environmental indicators and socioeconomic factors for calculating environmental justice (EJ) and supplemental indexes. EJScreen comprises twelve EJ indexes and twelve supplemental indexes in EJScreen, each representing twelve environmental indicators and either the demographic index (which includes the average of two socioeconomic factors) or the supplemental demographic index (which includes the average of five socioeconomic factors) (Table 8-3). Each environmental indicator and demographic index has its own separate EJ or supplemental index; there is no cumulative score or single EJ index.

The supplemental indexes provide a more comprehensive analysis. To calculate a specific EJ index, EJScreen applies a formula that combines an environmental indicator with the demographic index (EJ Index = the Environmental Indicator Percentile for a Block Group X the Demographic Index for a Block Group). Similarly, a formula is applied that combines a single environmental factor with the supplemental demographic indicator to calculate a single supplemental index (Supplemental Index = the Environmental Indicator Percentile for Block Group X Supplemental Demographic Index for Block Group). The smallest geographic unit for which census data is published is called a block, while a block group is a cluster of blocks that form a subdivision of a census tract.

The SFWMD utilizes the CDC SVI and CEQ CEJST to identify vulnerable and disadvantaged communities and rank projects both regionally (as depicted in Figures 8-7 through 8-9) and within project impact areas. EJScreen does not classify communities in an area as socially vulnerable or disadvantaged. Instead, it calculates environmental justice indexes to identify areas that may require further review, analysis, or outreach as the EPA and planners develop programs, policies, and other activities. The EJScreen Supplemental Indexes greater than or equal to the state and national 40th percentile serve as additional guides for SFWMD to leverage local knowledge of resiliency concerns and additional information to enhance socioeconomic and demographic considerations in resiliency planning.

Table 8-3: EPA EJScreen and supplemental indexes and corresponding indicators.

Environmental Justice (EJ) Index	Demographic Index	Supplemental Demographic Index
<ul style="list-style-type: none"> • Particulate Matter 2.5 • Ozone • Diesel Particulate Matter • Air Toxics Cancer Risk • Air Toxics Respiratory Hazard Index • Traffic Proximity • Lead Paint • RMP Facility Proximity • Hazardous Waste Proximity • Superfund Proximity • Underground Storage Tanks • Wastewater Discharge 	<ul style="list-style-type: none"> • % low income • % people of color 	<ul style="list-style-type: none"> • % low income • % unemployed • % limited English speaking • % less than high school education • low life expectancy

* Sources: [Understanding EJScreen Results | US EPA](#).

FEMA NRI

In addition to examining the social vulnerability and disadvantaged communities' datasets in isolation, there is merit in considering them alongside hazard exposure data. This is not primarily aimed at pinpointing vulnerable and disadvantaged communities. Instead, it offers an alternative approach to comprehending the unequal environmental hazards these communities are exposed to and the potential consequences of natural risk factors.

While the Federal Emergency Management Agency (FEMA) National Risk Index (NRI) doesn't introduce for identifying a new dataset for identifying socially vulnerable and disadvantaged communities, it aids in examining their relative risk concerning natural hazards and the potential impacts they could expect during or after a disaster. The FEMA NRI evaluates risk by evaluating three components, one for eighteen natural hazards and two for community risks (as detailed below and in Table 8-4).

Expected Annual Loss (EAL): This is the natural hazards component of the NRI. It represents the projected average economic loss in dollars due to annual natural hazards. EAL serves as a metric for estimating the impacts of natural hazards on communities. The hazards included in the risk index were selected based on State Hazard Mitigation Plans from January 2016. Data sources for these hazards vary (depending on the hazard type) and include the National Weather Service (NWS), the National Oceanographic and Atmospheric Association (NOAA), the U.S. Geological Survey (USGS), the U.S. Army Corps of Engineers (USACE), the Smithsonian databases, and the U.S. Department of Agriculture (USDA), among others.

Social Vulnerability: This is one of the two Community Risk Adjustment factors of the NRI. It utilizes the CDC/ATSDR SVI discussed earlier as the basis for characterizing potential impacts on vulnerable communities.

Community Resilience: This is the second of two Community Risk Adjustment factors of the NRI. It utilizes data on community resilience from the Hazards Vulnerability & Resilience Institute (HVRI) Baseline Resilience Indicators for Communities (BRIC) Index and includes a set of 49 indicators that represent six types of resilience as the basis for distinguishing the relative capacity of a community to effectively respond to and recover from the impacts of natural disasters.

Together, Social Vulnerability and Community Resilience constitute Community Risk Adjustment factors. These factors scale the EAL and ultimately amplify and reduce the NRI and the characterization of potential risks to communities from natural hazards. The adjustment increases the NRI with higher

Social Vulnerability and decreases the NRI with greater Community Resilience. This dynamic adjustment translates to higher Social Vulnerability results leading to elevated Risk Index values, while higher Community Resilience results lead to lowered Risk Index values. In essence, Social Vulnerability (drawn from CDC SVI data) and Community Resilience (derived from HVRI BRIC data) act as elements that amplify and counteract the potential impacts of the set of natural hazards. The following equation illustrates how the scores for the three components are combined to adjust the EAL through the application of the Community Risk Adjustment factors to calculate the NRI scores: Risk Index = Expected Annual Loss \times (Social Vulnerability \div Community Resilience).

The Risk Index scores are clustered using an algorithm that groups similar communities within each cluster while maximizing differentiation between clusters. This approach leverages the available source data for natural hazards (EALs) and community risk factors (social vulnerability and community resilience) to establish a relative baseline risk measurement for each U.S. county (or county-equivalent) and Census tract, indicating a community's national ranking in risk compared to others for a given component (individual or overall natural hazards) and level (county or census tract). Scores are presented as composite and individual scores for the eighteen hazard types.

The SFWMD utilizes the CDC SVI and CEQ CEJST to identify vulnerable and disadvantaged communities and rank projects both regionally (as depicted in Figures 8-7 through 8-9) and within project impact areas. The NRI ranking, falling in the moderate range or higher, serves as an additional resource for understanding the correlation between socioeconomic status and community risk. Figure 8-10 highlights locations within the SFWMD region where communities susceptible to natural hazards have been identified.

Table 8-4: FEMA NRI components.

Expected Annual Loss	Social Vulnerability	Community Resilience
<ul style="list-style-type: none"> • Avalanche • Coastal Flooding • Cold Wave • Drought • Earthquake • Hail • Heat Wave • Hurricane • Ice Storm • Landslide • Lightning • Riverine Flooding • Strong Wind • Tornado • Tsunami • Volcanic Activity • Wildfire • Winter Weather 	<ul style="list-style-type: none"> • Below 150% Poverty • Unemployed • Housing Cost Burden • No High School Diploma • No Health Insurance • Aged 65 & Older • Aged 17 & Younger • Civilians with a Disability • Racial & Ethnic Minority Status • Multi-Unit Structures • Mobile Homes • Crowding • No Vehicle • Group Quarters • Single-Parent Households • English Language Proficiency 	<ul style="list-style-type: none"> • Social • Economic • Community capital • Institutional capacity • Housing/infrastructure • Environmental

* Source: [Data and Methods | National Risk Index \(fema.gov\)](https://www.fema.gov/national-risk-index).

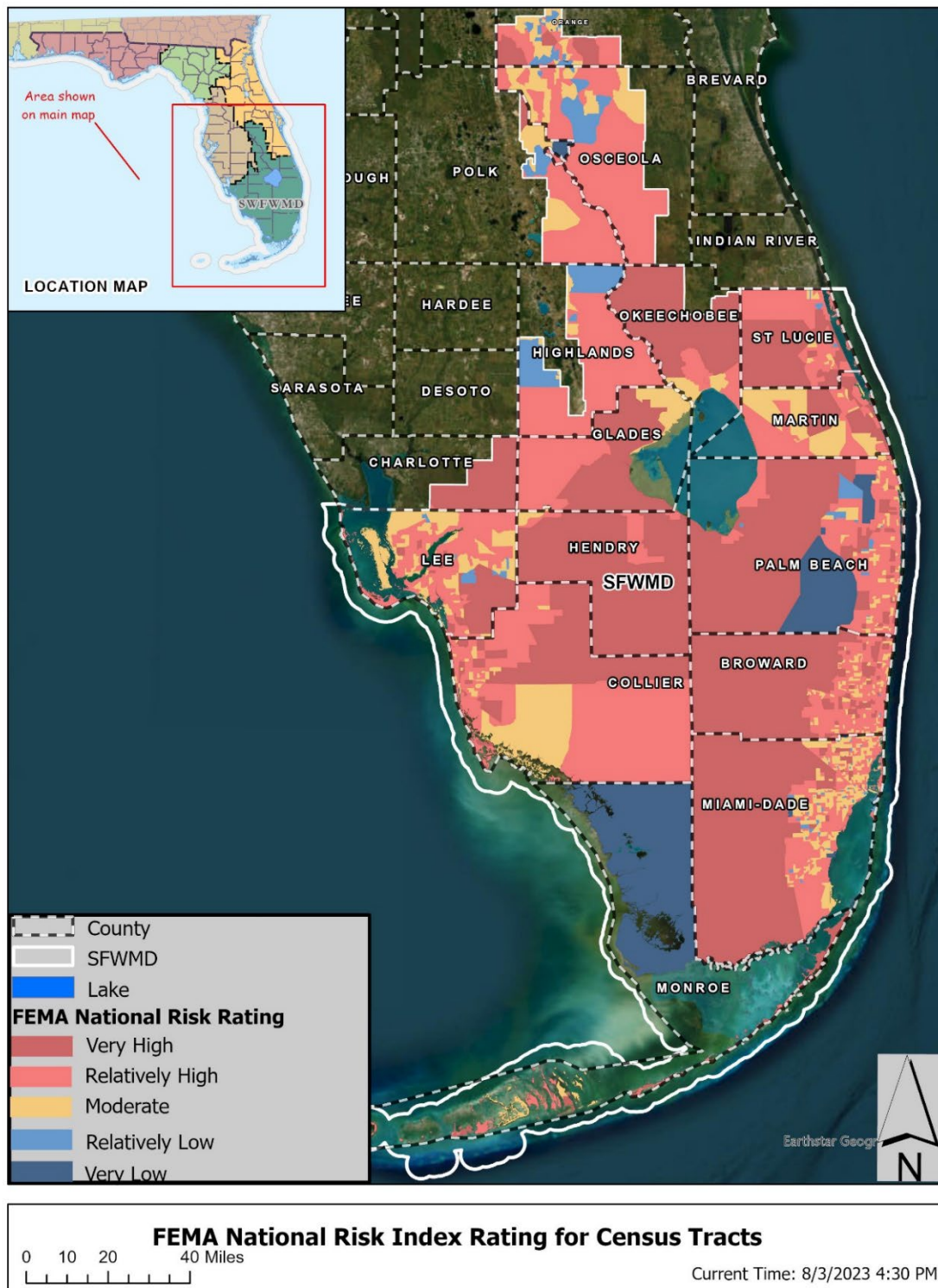

Figure 8-9: Relative natural hazard risk based on the FEMA NRI composite score for census tracts within the SFWMD region.

Proposed Ranking Criteria

A multi-criteria approach was developed to support the characterization and ranking of resiliency projects, including metrics that help to identify the most critical infrastructure associated with the most vulnerable areas. It is important to note that this ranking process is designed to help determine project needs and priorities in terms of advancing projects in the most vulnerable areas. There are additional factors and opportunities that might determine project funding.

The selection of criteria was based on the Resilient Florida Program, as detailed below. This program is administered by the Florida Department of Environmental Protection (FDEP), and it allows water management districts to submit a list of proposed projects that mitigate the risks of flooding or sea level rise on water supplies or water resources of the state by September 1, annually. Each project submitted to the program must contain a description of the project, project location, completion schedule, cost estimate, and the cost share percentage available with a minimum of 50%. The legislation requires FDEP to implement a scoring system for assessing each project. The scoring system will include the following tiers and criteria:

- Tier 1 must account for 40 percent of the total score and consist of all of the following criteria:
 - The degree to which the project addresses the risks posed by flooding and sea level rise identified in the local government vulnerability assessments or the comprehensive statewide flood vulnerability and sea level rise assessment, as applicable. (10%)
 - The degree to which the project addresses risks to regionally significant assets. (10%)
 - The degree to which the project reduces risks to areas with an overall higher percentage of vulnerable critical assets. (10%)
 - The degree to which the project contributes to existing flooding mitigation projects that reduce upland damage costs by incorporating new or enhanced structures or restoration and revegetation projects. (10%)

- Tier 2 must account for 30 percent of the total score and consist of all of the following criteria:
 - The degree to which flooding and erosion currently affect the condition of the project area (7.5%)
 - The overall readiness of the project to proceed in a timely manner, considering the project's readiness for the construction phase of development, the status of required permits, the status of any needed easement acquisition, and the availability of local funding sources. (7.5%)
 - The environmental habitat enhancement or inclusion of nature-based options for resilience, with priority given to state or federal critical habitat areas for threatened or endangered species. (7.5%)
 - The cost-effectiveness of the project. (7.5%)

- Tier 3 must account for 20 percent of the total score and consist of all of the following criteria:

- The availability of local, state, and federal matching funds, considering the status of the funding award, and federal authorization, if applicable. (6.5%)
 - Previous state commitment and involvement in the project, considering previously funded phases, the total amount of previous state funding, and previous partial appropriations for the proposed project. (6.5%)
 - The exceedance of the flood-resistant construction requirements of the Florida Building Code and applicable floodplain management regulations. (7%)
- Tier 4 must account for 10 percent of the total score and consist of all the following criteria:
 - The proposed innovative technologies are designed to reduce project costs and provide regional collaboration. (5%)
 - The extent to which the project assists financially disadvantaged communities. (5%)

Following the overall Resiliency Florida scoring system and incorporating additional criteria that are relevant to characterize and prioritize the most critical project needs in this Plan, the following criteria set has been implemented:

Criteria Set 1: Likelihood of System Deficiencies

FPLOS Phase I Assessment Results (Current and /or Future Conditions)

Basin-wide flood vulnerabilities, as part of FPLOS Phase I Assessment Results (or equivalent assessment): vulnerability of the drainage system within the project impact area to manage flood risks to adjacent developed or partially developed land under current and future conditions represented by the FPLOS overall flood protection level of service (i.e., 5-YR, 10-YR, 25-YR), as summarized in Phase I FPLOS Reports – Flood Vulnerability Assessments.

Note: When FPLOS Phase I Assessment Results are not yet available within the area of influence of a project, but significant flooding events have been recently reported (as detailed below), all points will be awarded to the proposed project.

Known Chronic and Nuisance Flooding Report

Observed flooding events, with documentation by agencies/universities/media/citizens providing evidence of significant flooding events in the project impact area in the past 5 years.

No Alternatives / Backup to Mitigate Worst Case Scenario

The respective structure does not have an alternative operational routing or no system backup to mitigate potential limitations in operation or the worst-case scenario of structure failure under extreme event conditions.

Return Period of Overbank Flooding

Infrastructure Performance Under Sea Level Scenarios or Extreme Rainfall Events (higher water levels exceeding infrastructure design capacity): Frequency that canal overbank flooding and/or other infrastructure bypass is observed onto the adjacent developed or partially developed floodplain (riverine flooding) as a result of peak stage profile at any point along the canal system being higher than canal bank/levee elevation (vulnerability of the drainage/flood protection system within the project impact area of the proposed project). Excludes overbank flooding of non-saline water that results primarily in inundation of wetlands or other natural areas.

Sea Level Resulting in Overbank Flooding

Infrastructure Performance Under Sea Level Scenarios or Extreme Rainfall Events (higher water levels exceeding infrastructure design capacity): Increase of sea levels that result in canal overbank flooding and/or other infrastructure bypass resulting in an increase in flood risks to developed or partially developed adjacent land and water supplies (vulnerability of the drainage/flood protection/salinity barrier system within the project impact area of the proposed project; the proposed project will reduce in inundated areas).

Exceedance of Canal Normal Operating Range

Infrastructure Performance Under Sea Level Scenarios or Extreme Rainfall Events (higher water levels exceeding infrastructure design capacity): Maximum peak stage profile levels along the primary canal system exceeding normal operational range stages (canal performance), which reduces discharges from secondary systems, increasing flood risks further inland. The project will lower canal stages (reduce inundated areas).

FFE < BFE

Infrastructure Finish Floor Elevation Exposure: Comparison between Infrastructure Finish Floor Elevation (FFE) and FEMA Base Flood Elevation (BFE), when applicable

FEMA Flood Zone (benefits set or likelihood set of criteria)

The project impact area is within FEMA Flood Zone A, AH, AE, and V and will lower flood risks (reduction of inundated areas).

Storm Surge Inundation Exposure

Project Impact Area (or Finished Floor Elevation, for infrastructure enhancement projects) is within specific Hurricane Categories - Storm Surge event inundated area, when applicable, and the project will lower flood risks (reduce inundated areas).

Criteria Set 2: Consequence of System Deficiencies

Critical Assets/Lifelines Density

The total number of Critical Assets (Lifelines: Water, Resource Facilities, Regional Medical Centers, Emergency Operations Centers, Regional Utilities, Major Transportation Hubs and Corridors, Airports, and Seaports) located within the project impact area of the proposed project.

The total number of Regional Significant Assets (Lifelines: Water, Resource Facilities, Regional Medical Centers, Emergency, Operations Centers, Regional Utilities, Major Transportation Hubs and Corridors, Airports, and Seaports) located within the project impact area of the proposed project.

Impact Area Across Administrative Boundaries

The number of administrative and County boundaries across the area of influence characterizes different levels of regional significance for the respective projects.

Social Vulnerability

CDC SVI: Percent of the communities within the proposed project's impact area are identified as socially disadvantaged based on datasets available from the Center for Disease Control (CDC) Agency for Toxic Substances and Disease Registry (ATSDR) Social Vulnerability Index (SVI) that consider economic status, household characteristics, ethnicity and race, and access to transportation to determine socioeconomic burden and vulnerability in a changing climate.

CEQ CEJST: Communities within the proposed project's impact area that are identified as socially disadvantaged and vulnerable based on one of the eight datasets available from the Council on Environmental Quality's (CEQ) Climate and Economic Justice Screening Tool (CEJST) that consider economic status, household characteristics, ethnicity and race, illness, air, land, and water pollution, transportation and traffic, green spaces, and workforce development to determine socioeconomic burden and vulnerability in a changing climate.

Environmental Protected Areas

Vulnerable environmental protected areas - state or federal critical habitat for threatened or endangered species- within the project impact area of the proposed project, and that can be impacted by flooding events.

Total Population

Total number of people residing within the project impact area of the proposed project

Public Water Supply Wellfields

Vulnerable public water supply wellfields within 20,000ft of the 2018/2019 Saltwater Interface and within the project impact area of the proposed project (when applicable – if the proposed project influences saltwater interface – dual purposes, e.g., coastal structures).

Adaptation Action Areas

The project impact area is within an established “Adaptation Action Area” or “Adaptation Area.” Section 163.3164(1), Florida Statutes defines AAA as "a designation in the coastal management element of a local government’s comprehensive plan which identifies one or more areas that experience coastal flooding due to extreme high tides and storm surge, and that are vulnerable to the related impacts of rising sea levels for the purpose of prioritizing funding for infrastructure needs and adaptation planning." Equivalent priority planning areas, as recommended by counties, were also identified within project impact areas.

Criteria Set 3: Benefits from System Enhancements**Nature-based Solutions**

The project includes nature-based solutions or green infrastructure in addition to “gray” infrastructure improvements to increase resiliency (Natural or semi-natural systems that provide water quality/ecosystem benefits and environmental habitat enhancement).

Ecosystem Restoration

The project included natural enhancements of the environment by restoring the lands and waters that benefit wildlife.

Cost Benefit Analysis

The cost-effectiveness of the project is estimated as larger than one, estimated based on avoided economic loss.

Previous State Commitment / Involvement

The project received previous state funding for its previous phases, including pre-construction activities, design, permitting, or Phase I Construction.

Available Match

The project includes documentation that 50% cost share is available, or funds will be available but have not been appropriated or released.

Florida Building Code Design Criteria

Exceedance of the flood-resistant requirements in the Florida Building Codes Act, as adopted by the State of Florida pursuant to Part IV, Chapter 553, F.S. or local floodplain management ordinances.

Innovative Technologies

The project proposal includes innovative technologies to optimize project benefits, protect communities and the environment, reduce project costs, and provide regional collaboration.

Criteria Set 4: Project Status (SIP/CIP Programs)**SIP Overall Rating-**

The performance level is used to define the ability of the structure to perform its intended function under current conditions, as reported as part of the SFWMD Structure Inspection Program Report (Final Category).

Capital Improvement Program (CIP) Status

Project Status as part of the District's fiscally constrained expenditure plan that lays out anticipated infrastructure investments over the next five years. Project indication about Design or Pre-Design is stated in the CIP.

Process for Applying Criteria

To apply the criteria sets detailed above, project impact areas were established for each project, as illustrated in the examples shown in Figure 8-14 below. Figures 8-15 through 8-18 summarize the ranking point assignment distribution, overall assumptions, and adopted weighting for each of the four categories of criteria. The project impact areas were determined based on potential benefits to the communities and the environment that the proposed infrastructure is expected to provide upstream and downstream of each project location. A wide range of information was considered to delineate the project impact areas, including, but not limited to, H&H modeling, design technical manuals, storm surge inundation scenarios, sea level rise and saltwater intrusion studies, environmental restoration and impact assessments, existing conditions reports, local engineering expertise and discussions with District's staff. Assumptions include the project's ability to protect the water supply and water resources of the state, increase the resilience levels of agricultural, natural, and urban areas to flood conditions, as well as improvement of wildlife corridors, habitat connectivity, salinity reduction, and water quality.

According to the Resilient Florida final rule language for Florida Rules Chapter 62S-8 Statewide Flooding and Sea Level Rise Resilience Plan, effective August 22, 2022, "Project impact area" means the discrete area the project encompasses as well as the delineated area that will be directly benefitted by a

mitigation project (such as a watershed or hydrologic basin for flood mitigation projects, service or sub-service area for a utility, a neighborhood, a natural area, or a shoreline).

All infrastructure projects receive a certain number of points for each of the evaluated criteria according to the evaluation of each respective project impact area and established weights. Projects with the highest combination of points become the highest priority projects. Table 8-9 below lists the infrastructure projects and presents the total points obtained for each criteria subset and overall points. Figures 8-19 through 8-23 illustrate some of these adopted criteria and how values vary spatially at each project impact area.

This ranking process will be updated continuously as part of future Resiliency Plan updates and as vulnerability assessment results and additional information becomes available. The new criteria established in this current plan differ from the criteria established in the 2021 Sea Level Rise and Flood Resiliency Plan, mainly because of the adoption of overall criteria and weights determined in the Resilient Florida final rule language for Chapter 62S-8 Statewide Flooding and Sea Level Rise Resilience Plan. Shifts in project priorities relative to the last planning cycle were observed and will be evaluated individually, as part of the next planning cycle. A higher weight, in comparison to Chapter 62S-8, was assigned to the Likelihood of System Deficiency subset, and notably the criteria relative to FPLOS Flood Vulnerability Assessment results, which characterizes the degree of flooding risks at each assessed basin, utilizing the latest and greatest input data and most advanced modeling tools, coupling rainfall, storm surge, and groundwater compound flooding risks.

Criteria	ID	Category	Weighting	Low Probability				High Probability
				1	2	3	4	5
Likelihood of System Deficiency	1.1	FPLOS Phase I Assessment Results (Current and /or Future Conditions)	15%	Future Conditions Less than 25-Year	Future Conditions 10-YR or less	Future Conditions 5-Yr or less	Current Conditions 10-YR or less	Current Conditions 5-YR or less
	1.2	Known Chronic and Nuisance Flooding Report (OR)	13%					Yes, flooded more than three times within the last five years or is experiencing ongoing erosion.
	1.3	No Alternatives/Backup to Mitigate Worst Case Scenario	3%			Partial		Yes
	1.4	Return Period of Overbank Flooding	6%	More than 100-yr	100-yr or less	50-yr or less	25-yr or less	5-yr or less
	1.5	Sea Level Resulting in Overbank Flooding		>3 ft	2 ft to 3 ft	1 ft to 2 ft	0.5 to 1 ft	0.5 ft or less
	1.6	Exceedance of Canal Normal Operating Range (OR)			Less than or Equal to 1 ft	More than 1 ft	> 2.5 ft	> 3.5 ft
	1.7	Finished Floor Elevation < Base Flood Elevation	3%			FFE < BFE + 1'	FFE < BFE + 2' (or 1' inland)	FFE < BFE + 3' (or 2' inland)
	1.8	FEMA Flood Zone Exposure						Yes
	1.9	Storm Surge Inundation Exposure				Yes, under Cat 3	Yes, under Cat 4	Yes, under Cat 5

Figure 8-11: Summary and Scoring System utilized for characterizing Criteria Set 1 “Likelihood of System Deficiency”

Criteria	ID	Category	Weighting	Low Probability				High Probability
				1	2	3	4	5
Consequence of System Deficiency	2.1	Critical Assets / Lifelines	6%			0-25% of Critical Assets are within areas lower than 6FT or within inundated areas from FPLOS	25-50% of Critical Assets are within areas lower than 6FT or within inundated areas from FPLOS	More than 50% of Critical Assets are within areas lower than 6FT or within inundated areas from FPLOS
			6%			1 or more RS Critical Assets	3 or more RS Critical Assets	5 or more RS Critical Assets
	2.2	Impact Area Across Administrative Boundaries	2.5%	1 County		1 County & 2 Administrative Boundaries		> 2 Counties & > 2 Administrative Boundaries
	2.3	Social Vulnerability (CDC SVI)	5.0%				0.4 - 0.6	> 0.6
		Social Vulnerability (CEQ CEJST)						Yes
	2.4	Environmental Protected Areas	3.5%	Lower Density		Average		Higher Density
	2.5	Total Population	1%	Up to 50,000 people	Up to 100,000 people	Up to 200,000 people	Up to 500,000 people	More than 500,000 people
	2.6	Public Water Supply Wellfields	5%	Lower Density		Average		Higher Density
2.7	Adaptation Action Areas	1%	Does not Intersect Adaptation Action Area				Intersect Adaptation Action Area	

Figure 8-12: Summary and Scoring System utilized for characterizing Criteria Set 2 “Consequence of System Deficiency”

Criteria	ID	Category	Weighting	Low Probability				High Probability
				1	2	3	4	5
Benefits from System Enhancement	3.1	Nature-based Solutions	5%					Yes
	3.2	Ecosystem Restoration						Yes
	3.3	Cost Benefit Analysis	2.5%					BCA Larger than 1
	3.4	Previous State Funding	2.5%		Previous State Funding utilized in Preconstruction activities	Previous State Funding utilized in Design	Previous State Funding utilized in Permitting	Previous State Funding utilized in Construction
	3.5	Available Match	2.5%			Specifically identified local, state, or federal cost share, but the funds have not been appropriated or released at the time the applicant submits its proposal to the FDEP		Approved and adopted capital improvement plan
	3.6	Florida Building Code Design Criteria	2.5%					Yes
	3.7	Innovative Technologies	5%					Yes

Figure 8-13: Summary and Scoring System utilized for characterizing Criteria Set 3 “Benefits from System Enhancement”

Criteria	ID	Category	Weighting	Low Probability				High Probability
				1	2	3	4	5
Project Status (SIP / CIP Programs)	4.1	SIP Overall Rating	5%			Overall C-3 or N/A	Overall C-4	Overall C-5
	4.2	Capital Improvement Program (CIP) Status	5%	Issue ID & Risk Ranking	PDR Approved / Project Kick-off Meeting and/or Suvey & Geotech Commenced	Partial Design	Design Complete / Permit Application Submitted	Initiated Construction





Figure 8-14: Summary and Scoring System utilized for characterizing Criteria Set 4 “Project Status (SIP/CIP Programs)”

Table 8-5: Ranking of Coastal Structure Projects (top) and Priority Projects (bottom)

Coastal Structure Resiliency Projects	Likelihood of System Deficiency	Consequence of System Deficiency	Benefits from System Enhancement	Project Status	Total Points
S-26	38.25	24.16	18.75	5.00	86.16
S-29 & C-9 Basin Resiliency	35.30	24.16	17.50	4.00	80.96
S-27 & C-7 Basin Resiliency	39.50	21.26	16.25	3.00	80.01
S-21	39.50	19.26	16.25	4.00	79.01
G-57	37.05	21.56	16.25	4.00	78.86
S-28 & C-8 Basin Resiliency	36.50	21.06	16.25	3.00	76.81
S-37A	33.50	22.96	16.25	3.00	75.71
S-25B	35.25	15.06	18.75	5.00	74.06
G-58	39.50	14.01	16.25	4.00	73.76
G-93	33.50	18.01	16.25	6.00	73.76
S-22	36.50	16.96	16.25	3.00	72.71
S-25	37.00	15.26	16.25	3.00	71.51
S-197	37.05	13.35	16.25	3.00	69.65
G-54	27.50	22.76	16.25	3.00	69.51
S-20F	26.50	20.76	16.25	5.00	68.51
G-56	26.30	22.96	16.25	3.00	68.51
S-13	31.65	16.96	16.25	3.00	67.86
S-36	29.30	17.76	16.25	3.00	66.31
S-20G	26.50	17.01	16.25	4.00	63.76
S-123	26.50	16.76	16.25	3.00	62.51
S-33	19.30	22.56	16.25	3.00	61.11
S-20	26.50	13.35	16.25	3.00	59.10
S-21A	23.50	13.01	16.25	5.00	57.76

Other Priority Projects	Likelihood of System Deficiency	Consequence of System Deficiency	Benefits from System Enhancement	Project Status	Total Points
Big Cypress Basin Microwave Tower	39.50	22.96	17.50	4.00	83.96
S-61 Spillway Enhancement and Erosion Control	36.50	23.16	16.25	7.00	82.91
C-29, C-29A, C-29B and C-29C Canal Conveyance Improvements	36.50	23.16	16.25	6.00	81.91
S-59 Enhancement and C-31 Canal Conveyance Improvements	36.50	23.16	16.25	6.00	81.91
S-58 Structure Enhancement and Temporary Pump	36.50	23.16	16.25	6.00	81.91
L-31E Levee Improvements	35.85	20.16	16.25	4.00	76.26
EMMA	37.00	13.35	18.13	7.00	75.48
Corbett Levee Water Control Structures	36.25	15.01	17.50	6.00	74.76
South Miami-Dade Curtain Wall	31.00	21.96	18.75	3.00	74.71

Legend**Priority Levels**

	High
	Medium High
	Medium
	Low

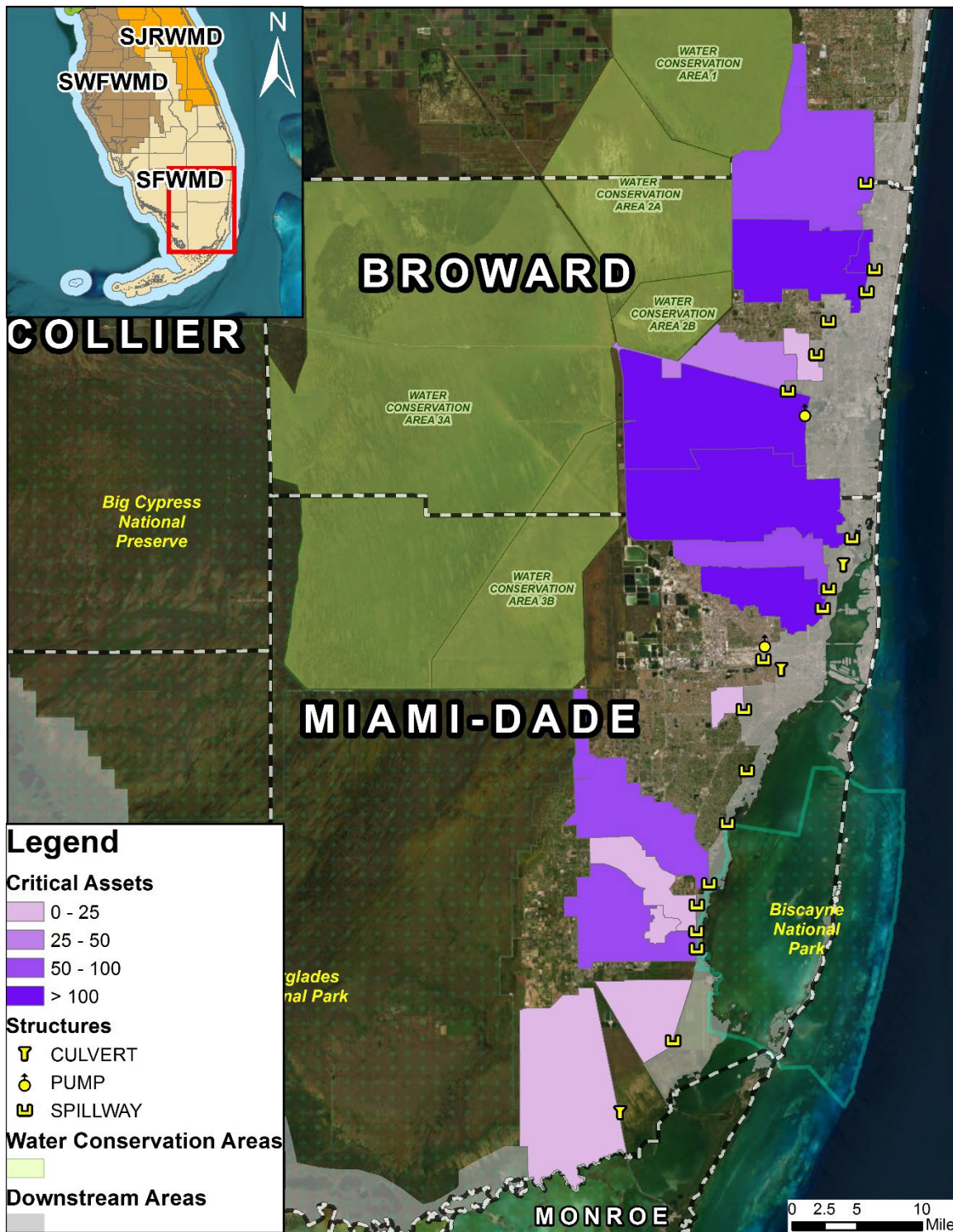

Figure 8-15: Critical Assets (Lifelines) per Coastal Structures Resiliency Project Impact Areas, utilized as part of the Resiliency Projects Ranking Criteria Set 2

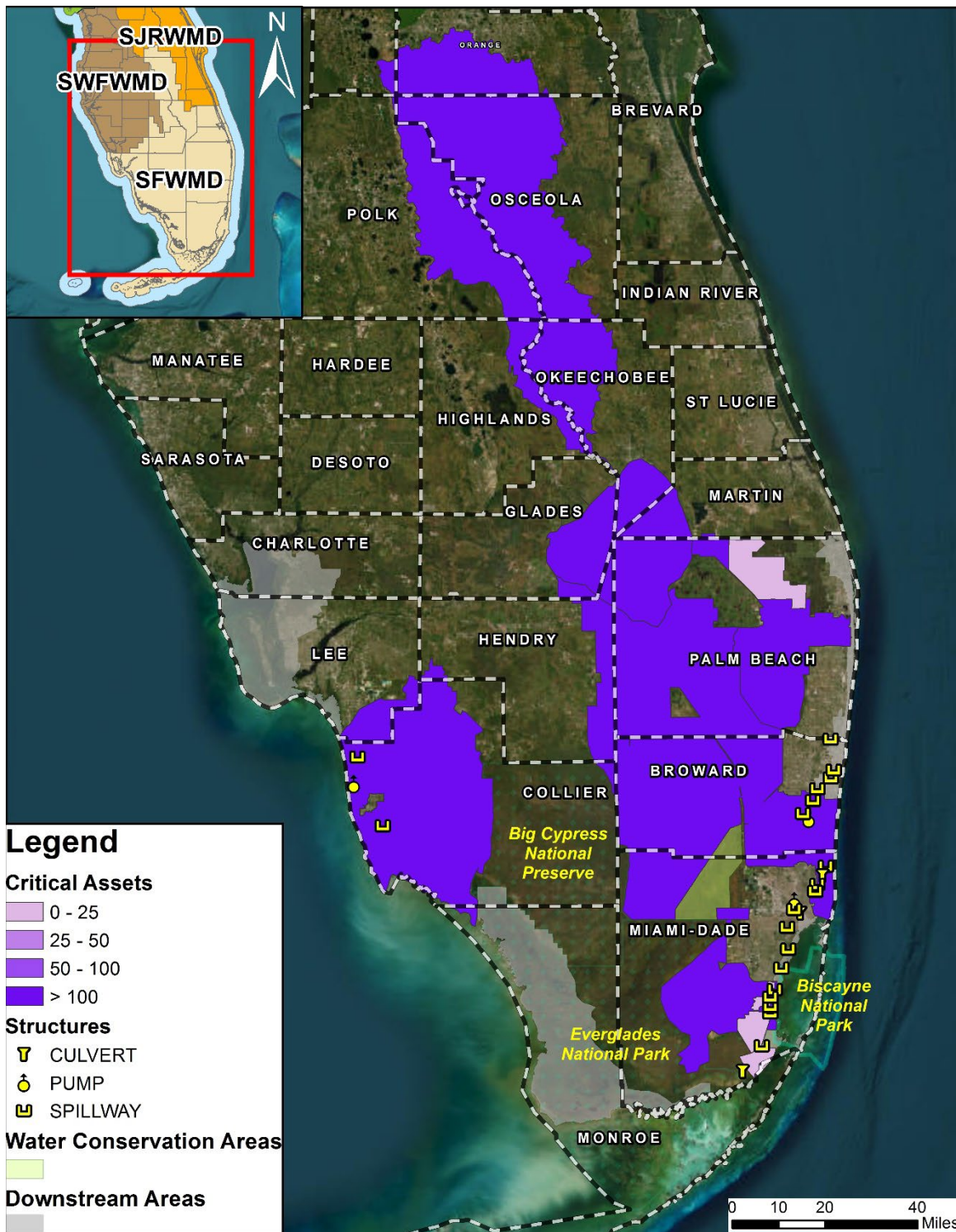

Figure 8-16: Critical Assets (Lifelines) per Other Priority Project Impact Areas, utilized as part of the Resiliency Projects Ranking Criteria Set 2

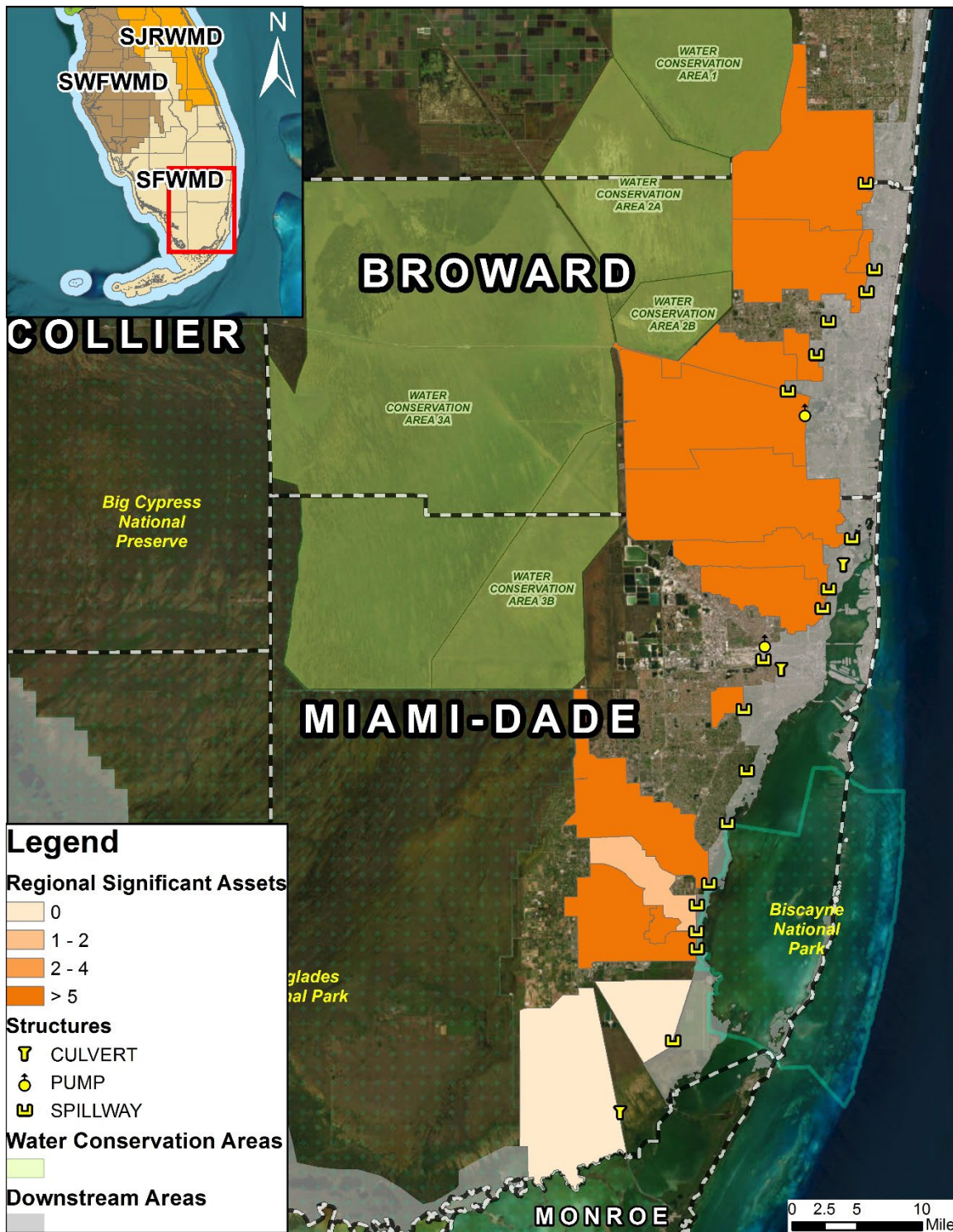

Figure 8-17: Regional Significant Assets per Coastal Structures Resiliency Project Impact Areas, utilized as part of the Resiliency Projects Ranking Criteria Set 2

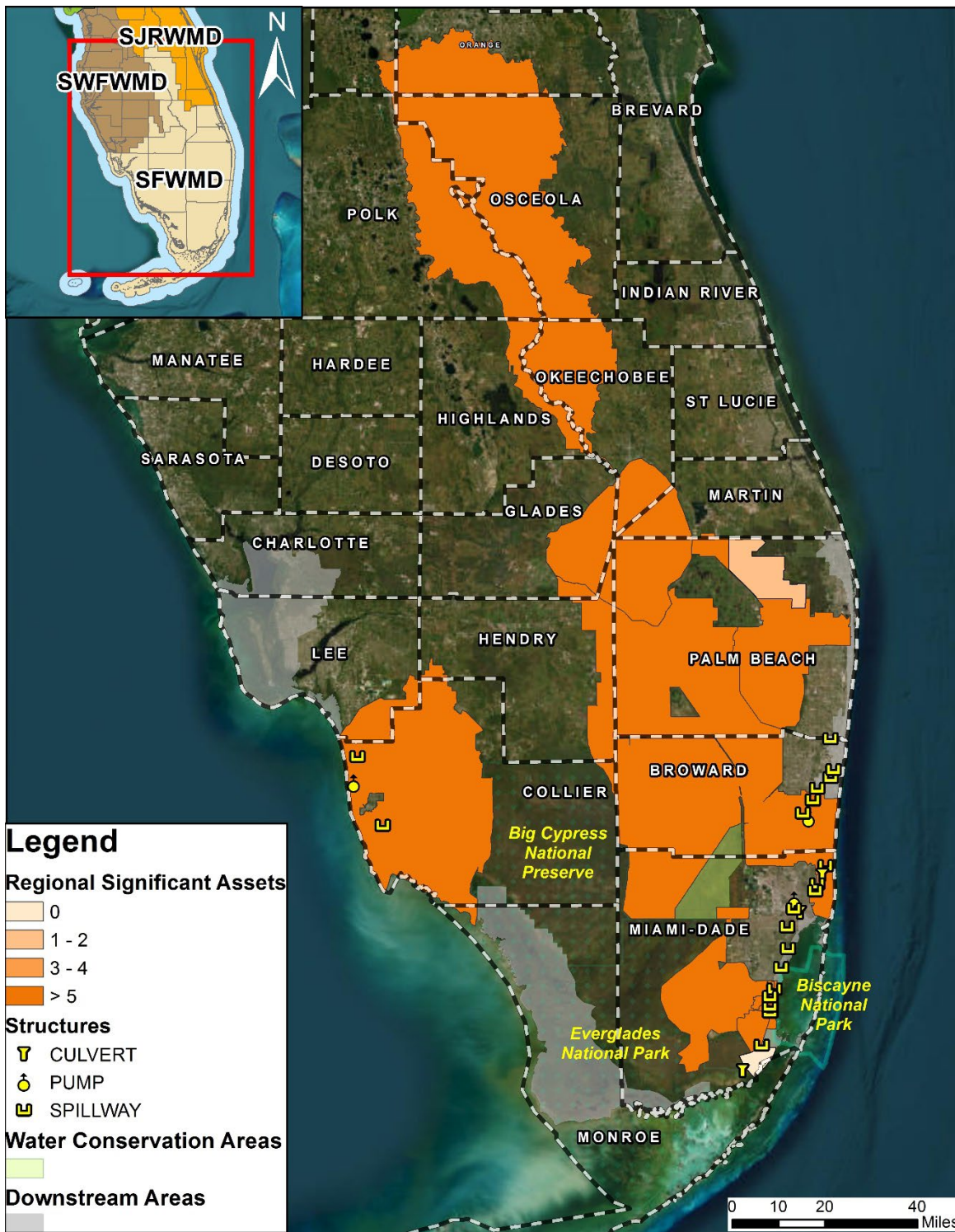

Figure 8-18: Regional Significant Assets per Other Project Impact Areas, utilized as part of the Resiliency Projects Ranking Criteria Set 2

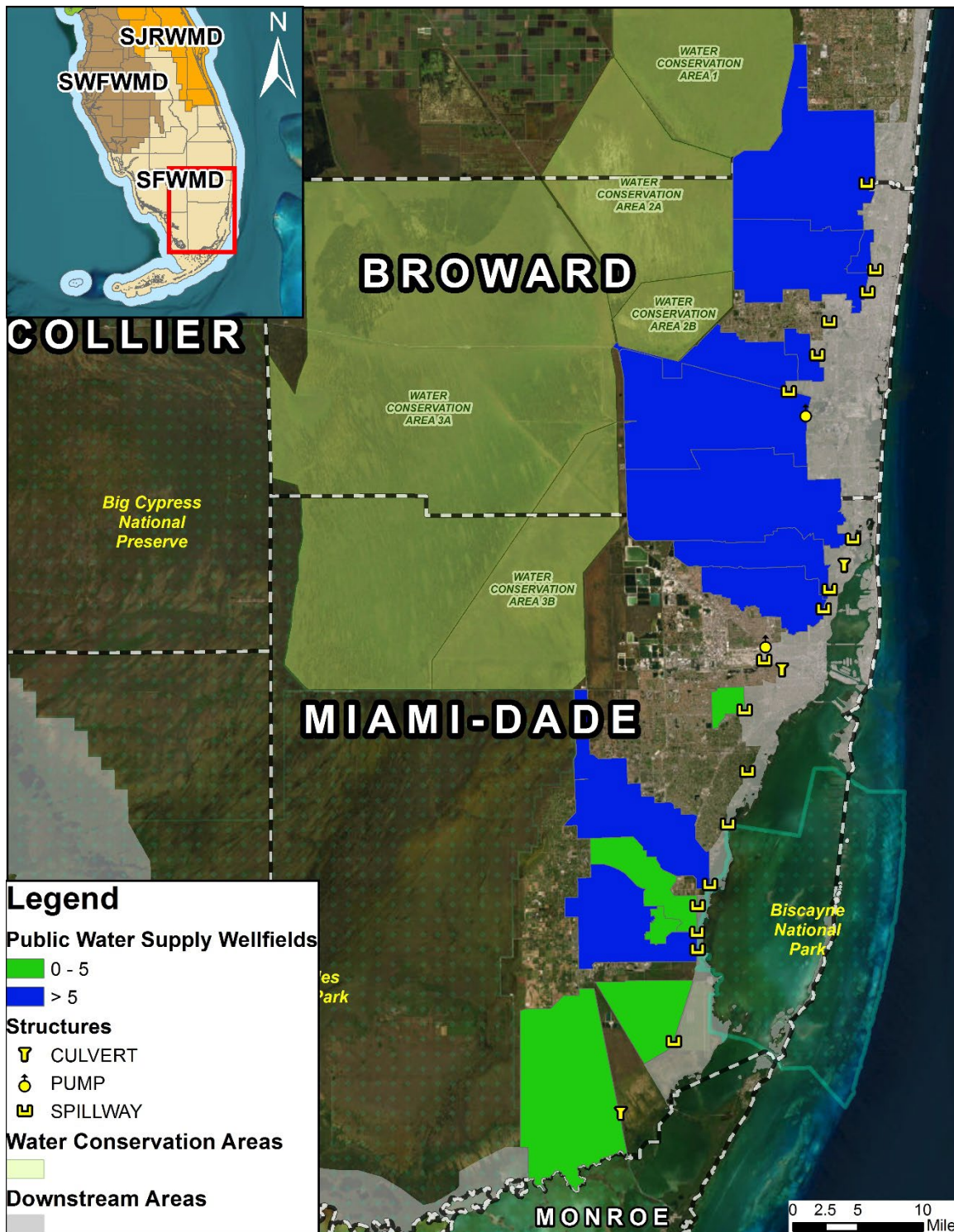

Figure 8-19: Public Water Supply Wellfields per Coastal Structures Resiliency Project Impact Areas, utilized as part of the Resiliency Projects Ranking Criteria Set 2

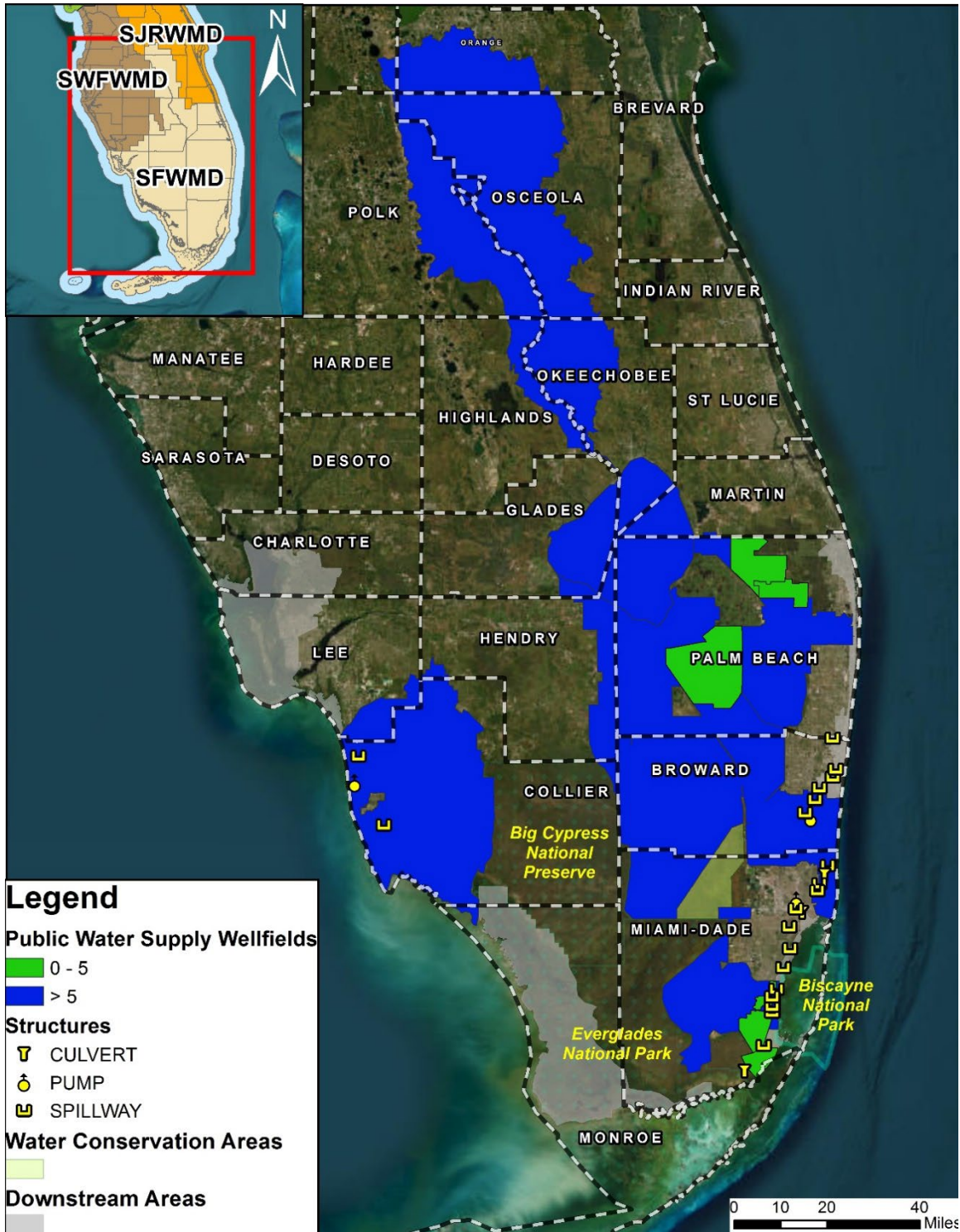

Figure 8-20: Public Water Supply Wellfields per Other Project Impact Areas utilized as part of the Resiliency Projects Ranking Criteria Set 2

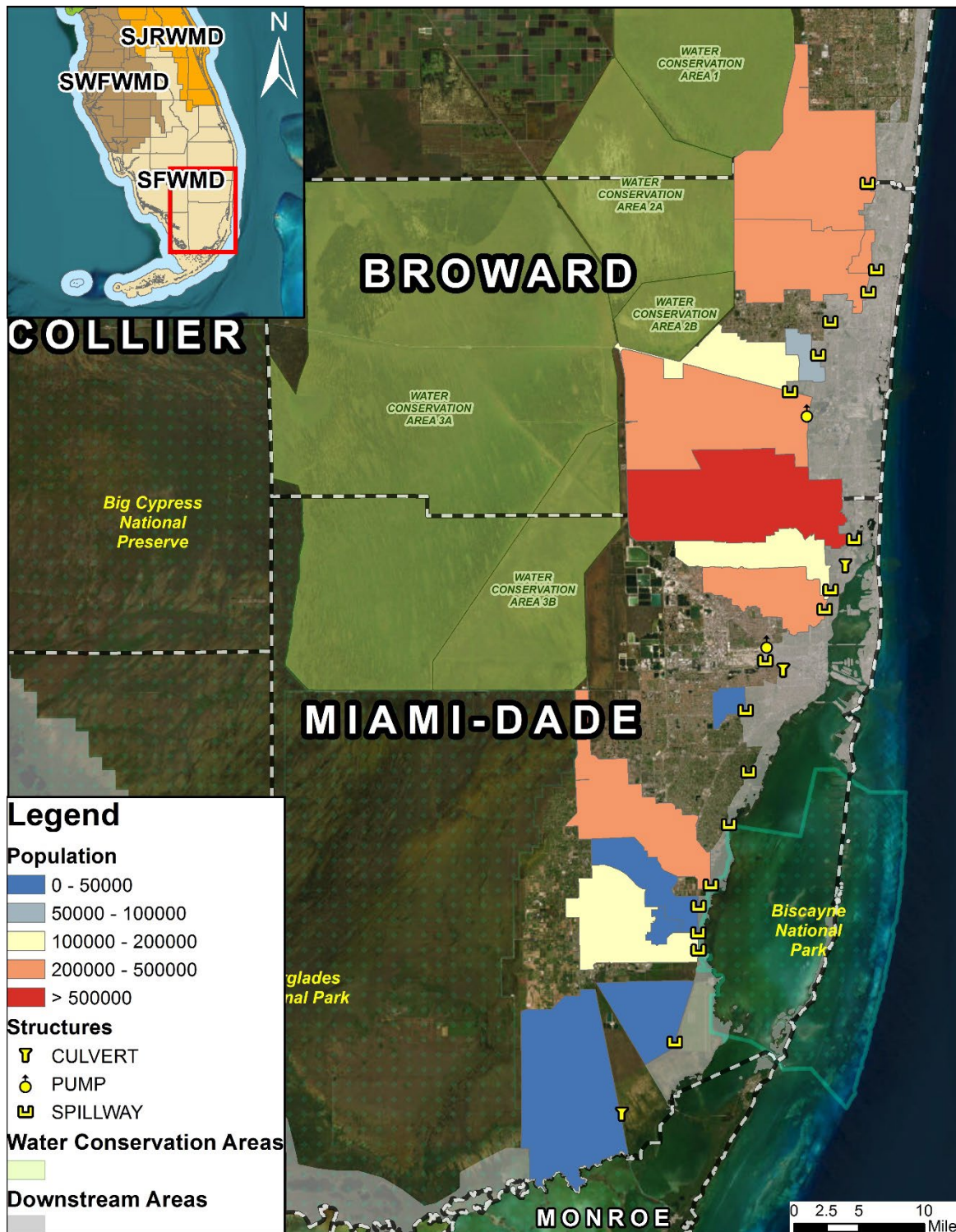

Figure 8-21: Total Population per Coastal Structures Resiliency Project Impact Areas, utilized as part of the Resiliency Projects Ranking Criteria Set 2

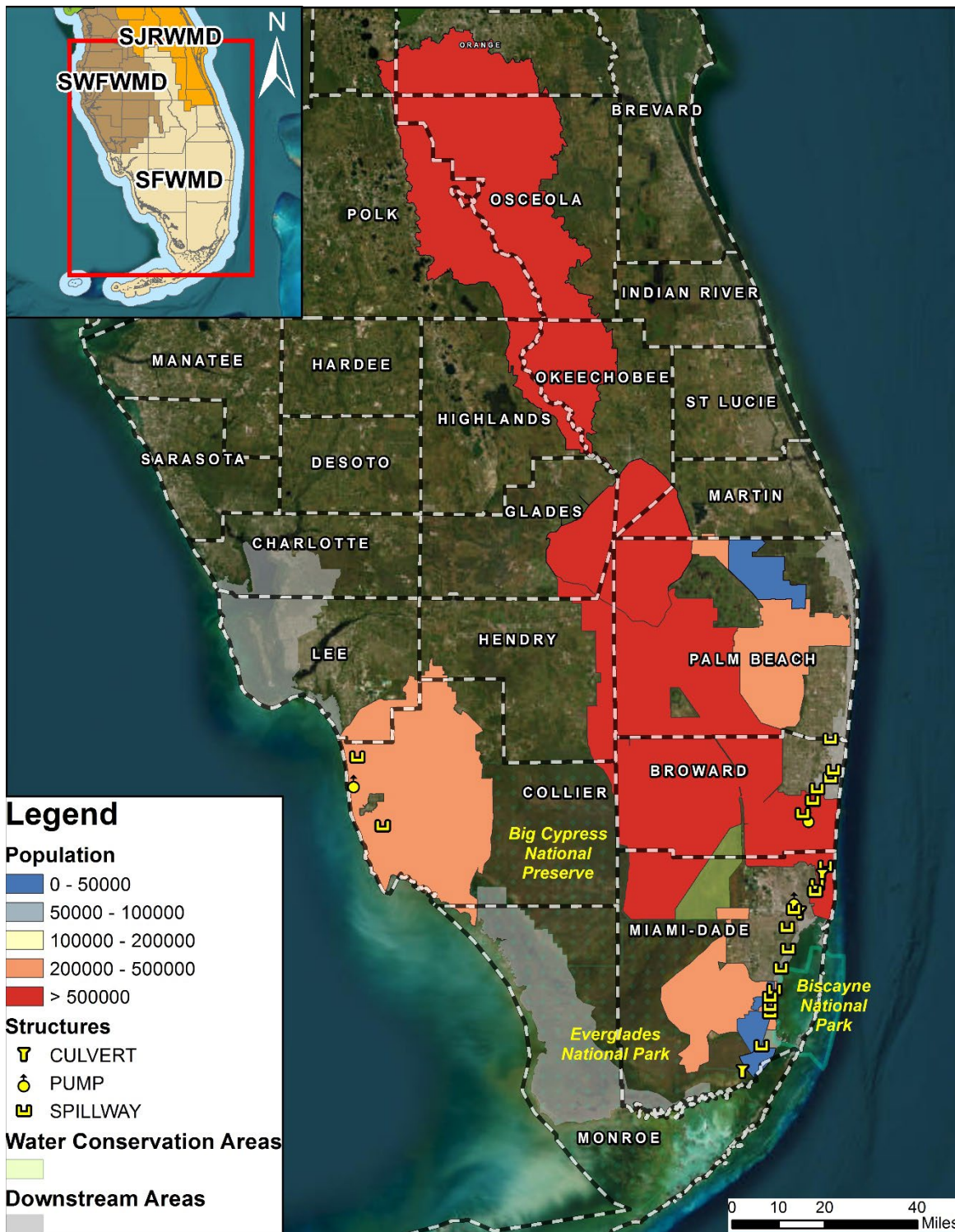

Figure 8-22: Total Population per Other Project Impact Areas utilized as part of the Resiliency Projects Ranking Criteria Set 2

9: Enhancing our Water Management Systems: Priority Implementation Projects

SFWMD Mission and Resiliency

The District's mission is to safeguard and restore South Florida's water resources and ecosystems, protect communities from flooding, and meet the region's water needs while connecting with the public and stakeholders. Resiliency for current and future conditions is embedded in each mission element:

Flood Control

Flood Control has been part of the District's mission since its creation as the Central and Southern Florida Flood Control District in 1949. Operations and Maintenance staff operate and oversee approximately 2,175 miles of canals and 2,130 miles of levees/berms, 89 pump stations, 915 water control structures, and weirs, and 621 project culverts. As part of this responsibility, the District has been implementing its Capital Improvement Program (CIP) to ensure investment in the maintenance of the flood control assets, a Structure Inspection Program (SIP) to routinely inspect and assess the structural integrity and operation of the flood control assets and, more recently, the Flood Protection Level of Service (FPLOS) program to comprehensively assess the system's ability to meet and continue to meet the flood protection needs of the region into the future. These programs are critical to keeping South Florida habitable and its primary flood control system functioning as designed today and into the future.

Water Supply Planning

Water supply planning is essential to meet the growing demands of 9 million residents, millions of visitors, businesses, and the environment. Section 373.790 F.S. requires the District to develop and update regional water supply plans approximately every five years with a planning horizon of 20 years to ensure that the available water resources in the region are sufficient to meet future water needs. These plans also identify measures to achieve demands where deficiencies are found, including promoting water conservation and the use of alternative water supplies. The District has taken steps to include sea level rise and climate change impacts in water supply planning efforts and maintains a Saltwater Interface Monitoring and Mapping Program to determine the approximate location of the saltwater interface since 2009, with updated maps every five years. Future conditions saltwater intrusion scenario projections are being simulated as part of the upcoming Lower East Coast Water Supply Plan and follow-up water supply vulnerability assessment.

Ecosystem Restoration

Numerous ecosystem restoration projects are being planned, built, and operated to protect and preserve South Florida's unique ecosystems, including the Everglades, the Kissimmee River, Lake Okeechobee, and a diverse array of coastal watersheds. The most prominent of these efforts is the Comprehensive Everglades Restoration Plan (CERP), a cost-share partnership between the State of Florida and the Federal government to restore, protect and preserve the greater Everglades. Ecosystem Restoration supports the District's efforts to address the effects of climate change and sea level rise by building systemwide resiliency. Completed CERP projects will increase the District's ability to better manage anticipated extreme weather events. The restoration of beneficial freshwater flows throughout the system slows down saltwater intrusion promoting more sustainable aquifer recharge rates, healthier estuaries and bays, more stable coastlines, and reduced occurrence of marsh dry-outs.

This Resiliency Plan document, and particularly the list of priority implementation projects included in this chapter, reflects the status of resiliency incorporation into each of the District's mission elements, summarized above. As demonstrated throughout the document and in the list and figure below (Figure 9-1), resiliency strategies in support of the District's water supply mission are still in a relatively nascent (emerging) stage, when typical efforts are characterized by vulnerability assessments and exploratory studies, with more short-term and localized adaptation strategies being prioritized. The flood protection mission is in a more advanced and transforming stage, with resiliency strategies that include adaptation, supported by robust technical assessments in place for over a decade through the FPLOS Program. Therefore, the flood resiliency projects included in this chapter are supported by detailed technical analysis with consideration for how these projects are sized to address current and future evolving conditions. Similarly, work in support of ecosystem restoration, including model development, analyses, implementation of projects, and assessment of project performance, is substantive and has been implementing resiliency projects in South Florida for over two decades time. More recently, restoration studies are integrating sea level rise as part of future conditions assessments, such as the Biscayne Bay Southeastern Everglades Ecosystem (BBSEER) study. The goal over the next decade is to move each of the mission areas to mature stages as adaptation strategies become clearer and more comprehensive for building resiliency in South Florida.

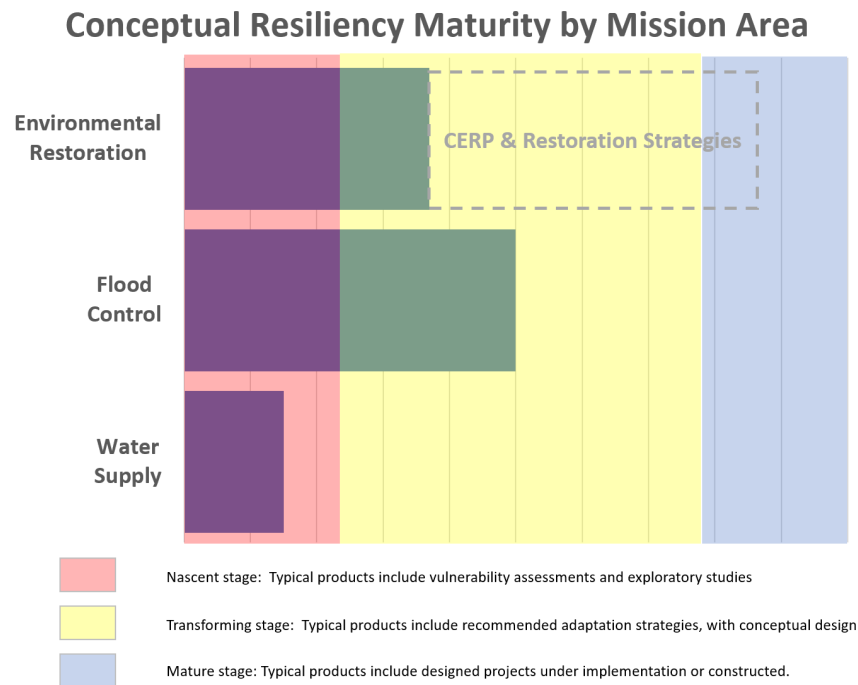

Figure 9-1: Conceptual Resiliency Maturity by Mission Area

It is important to recognize that this plan is constantly evolving. The objective is to incorporate resiliency strategies that include robust adaptation solutions supported by integrated technical assessments, detailed analyses, and projects designed to address current and future conditions. The primary sources of projects formulated for this plan are detailed in Figure 9-2 and include FPLOS Phase II Studies, FPLOS Phase I Studies, Post Storm/Event Response, CIP, and Innovative Projects. Recommendations with the strongest technical support are listed first. These are the projects that have been validated with the most advanced modeling and future scenario assessments.

FPLOS Phase II project recommendations are the result of robust, comprehensive feasibility studies that evaluate a set of alternative adaptation strategies throughout the system (including primary, secondary, and tertiary systems). These studies assess the potential effects of implementing the project and the quantified benefits for flood risk reduction basin-wide, which will inform the basis for design as the following step. FPLSO Phase II recommendations also include project sequencing so that planning is adaptable to evolving conditions and projects are implemented as needed and based on the determination of thresholds established to maintain an appropriate flood protection level of service.

FPLOS Phase I project recommendations are projects identified based on the results of flood vulnerability assessments, not yet validated through adaptation planning modeling. They include no-regret strategies such as enhancing coastal structures, building forward pump stations, storage options, and flood barriers

at coastal structures. Post Storm or Event response recommendations are developed based on the characterized impacts and pre-identified response actions to extreme events such as hurricanes and extreme rainfall events. During and after extreme events, the District water managers operate the system in the most efficient manner and might make adjustments to how the system is operated to help relieve flooding, as needed. Event response project recommendations aim to build upon what is learned from pre-, during- and post-storm operations, along with observed limitations to the water management system, and develop best response strategies for system enhancement. Capital Improvement Plan project recommendations are projects that are based on CIP and Operations and Maintenance regular needs. These projects are driven by the need to replace, repair, and/or enhance aging or damaged flood control infrastructure and are aligned with resiliency goals. Innovative Project Recommendations are new and innovative ideas that may need to be further assessed before they are fully developed. They can include project features such as nature-based solutions and/or renewable energy project features. Project features that are the result of grant funding requirements often fall under this category as well.

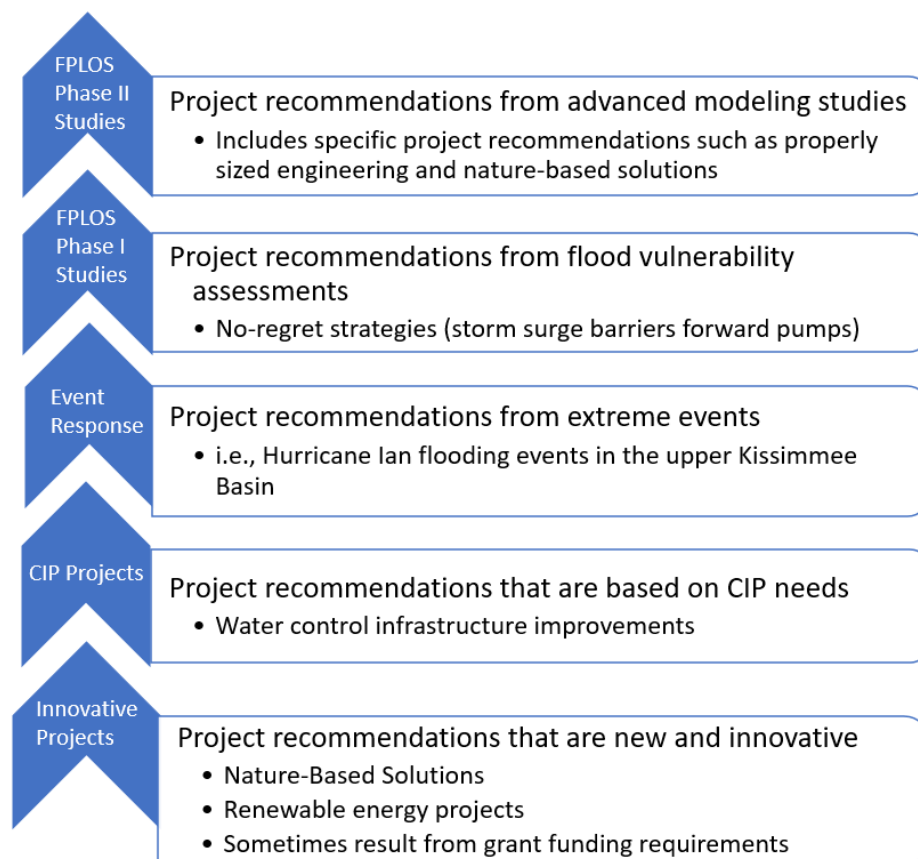

Figure 9-2: Diagram describing how projects are formulated and entered into this plan.

Resiliency Priority Implementation Projects – Cost Estimates

The list of priority resiliency implementation projects includes investments needed to increase the resiliency of the District’s coastal structures, such as structure enhancement recommendations and additional sea level rise adaptation needs that include nature-based solutions along with traditional gray infrastructure enhancements. These projects represent urgent actions to address the vulnerability of the existing flood protection infrastructure. Additional project recommendations comprise basin-wide flood adaptation strategies that are based upon FPLOS recommendations that protect the water supply and water resources of the State. Examples of these projects include adding “self-preservation mode” functionality to water control structures, construction of the South Miami-Dade Curtain Wall, L31E Levee improvements, the J.W. Corbett Wildlife Management Area Hydrologic Restoration and Levee Resiliency project, and the Everglades Mangrove Migration Assessment project (EMMA). The EMMA project is being proposed to capture the adaptive foundational resilience of coastal wetlands within the District and to demonstrate the ability of coastal wetlands to adapt to rising sea levels via enhanced soil elevation change. Each of these projects helps to increase the functionality and capacity of the District’s flood control system and protection of the environment.

Many of the projects described in this plan include adding forward pump stations to coastal water control structures to restore the original flood protection level of service. These projects can have downstream impacts. As part of the ongoing C&SF Flood Resiliency Study, USACE’s and SFWMD’s engineers and water managers will have the opportunity to assess the conditions downstream of the coastal structures and establish not only current conveyance challenges but also the impacts of sea level rise and potential mitigation flood risk management strategies on the downstream reaches. Nature-based features are being included as part of recommended strategies to provide ancillary water quality benefits.

The cost estimates for structure improvements were prepared using the District’s current understanding of construction costs in the marketplace and historical costs from projects of similar scope. Additionally, the District followed cost-estimating procedures such as those employed by the U.S. Army Corps of Engineers. The initial sizing of each proposed pump station is based on the recent FPLOS study results. The pump station discharge capacity was calculated using one-quarter of the design discharge capacity of the structure. For instance, a structure with a discharge capacity of 1000 cfs would need a 250 cfs pump station.

The pump station cost estimates were calculated by a Professional Engineer certified in the State of Florida. Estimates were based on the District’s record of pump station costs from 2006 to the present and adjusted for coastal conditions in Miami-Dade County. The cost estimates for each forward pump station were calculated based on the range of pumping capacity of the pump station (Table 9-1). For example, a

250 cfs pump station would cost \$13,750,000 as the cost per unit of discharge for the “up to 250 cfs range” is \$55,000. All estimated costs include backup generators, as appropriate, and the schedules for implementation of the Coastal Structure Refurbishment and Forward Pump Projects are estimated at an average of 1.5 years for design and 2.5 years for construction. Schedules will be adjusted based on confirmation of project implementation. Real Estate costs were determined for the S-27 and S-29 Coastal Structures and range from \$8M - \$16M depending on the project footprint and the land use within the areas surrounding the project. An initial placeholder of \$7M for real estate costs, as well as \$2M for tying the structure back to a higher elevation, was included in all the structure cost estimates and will be refined during the pre-design stage. Cost estimates for forward pumps and respective backup generators (at 10% of pump total costs) are also included, but forward pumps may not be recommended for all the structures. Feasibility studies, conducted as part of FPLOS Phase II efforts, will confirm the need for forward pumps. All cost estimates have been updated for 2023 according to SFWMD Engineering and Construction recommendations, based on the building structure cost index adjustment from January 2022 to June 2023 of 2% lower than the 2022 estimates.

All newly developed structures and components will exceed existing and expected future flood-related codes. The State of Florida Building code established the minimum floor elevation by determining the Baseline Flood Elevation (100-year flood line) per ASCE 24-14, plus 1 (one) foot. The Miami-Dade County Code (Chapter 11C) is at regulatory flood elevation (100-year flood).

Table 9-1: Summary of Cost Assumptions

Pump Capacity % (from Design Discharge)	
Medium and High Impact Structures	50%
Medium, Medium Low, and Low Impact	25%

Forward Pump Cost Estimates		
Cubic Feet per Second	Threshold	Cost per Unit Discharge
Up to 250	250	\$68,750
250-500	500	\$66,250
500-750	750	\$63,750
750-1000	1000	\$62,500
>1000	Other	\$60,000

Real Estate Costs – Placeholder Average Costs	\$8,750,000
Forward Pump Backup Generator	10% of forward pump costs
Tie-back (flood barriers around coastal structure)	\$2,500,000

Capital Improvement Plan – Priority Projects

Priority resiliency implementation projects were evaluated to confirm that an integrated strategy for implementation is being used. An analysis was completed to identify how each individual CIP project is related to this plan’s recommended resiliency projects. The analysis identified projects that have common objectives or overlapping impact areas and that can optimize benefits and continue to ensure that the water management system is operating at peak efficiency.

The District CIP infrastructure investments have been making system improvements beyond the needs identified in Operations and Maintenance inspection reports. These investments are enhancing District’s water management systems with additional components and operational capacity, making it possible for the 70-plus-year-old system to function and ensuring the District’s flood control mission is accomplished. These ongoing resiliency investments, along with proposed enhancements that account for future conditions, are being implemented through a bundling strategy. Table 9-2 presents a list of CIP projects that will continue to enhance the Central and Southern Florida (C&SF) System and Big Cypress Basin. More information about these projects can be found in the District’s CIP.

Table 9-2: List of CIP priority projects.

Category	Project Names
Canal and Levee Conveyance	C-100A Tree Removal & Bank Stabilization C25 Canal Bank Repairs (Hurricane Irma) Canals C16, G16, C14, C41, C1W, C1N, C15 C40, C23, C24, C25 Dredge/Bank Stabilization Hillsboro Package 3 L8 Tieback – Boil Repair/Dupuis Canal Backfill
Communication/Control and Telemetry Upgrades and Replacement	Manatee Gate Control Panel Replacements Picayune Command & Control Center SCADA Stilling Well/Platform(C&SF) SCADA Stilling Well/Platform (STA) Tower Repair Program
Field Facilities Construction Upgrades and Replacement	Fort Lauderdale Field Station Modifications Homestead Field Station Replacement Miami Field Station Modifications and Replacements Gate Overhauls: Sandblast, Air Compressor Facilities Underground Storage Tank Replacements West Palm Beach Field Station Modifications O&M Facility Construction/Improvements Staff Support
Project Culvert Replacement	Large Project Culvert Replacements – Multiple Sites PC Culvert Project Replacements & Removals – MS PC Replacements ~ STCL FS PC to Bridge conversion PC Replacements ~ WPB FS Area, 6 Sites on L15

Category	Project Names
Pump Station Upgrades and Replacement	Arc Flash Program Automation Upgrades: G310, G335, S319, S362 G-251 Dewatering Provision G310 Trash Rake Refurb/Replace G-310/G-335 Pump Overhaul G335 Trash Rake Refurb/Replace G370/372 Trash Rake, Fuel Farm & Structural L8 FEB / G539 PS – Resiliency Upgrades L8 FEB Flap Gate Purchase / Retrofit Pump/Engine Overhauls (C&SF) Pump/Engine Overhauls (C&SF) Grant Pump/Engine Overhauls (STA) S2, S3, S4 Pump Refurbishments S2, S3, S4, S7, S8 Engine Control Panel Hardening S-331 Command & Control Center Comm (Multiple Sites) S6 Package 1 S6 Pump Refurbishment S7 Pump Refurbishment S-9/S-9A Trash Rakes & Refurbishment Pump Station Modification/Repair Staff Support
Structure Upgrades and Replacement	Fall Protection G57 Wingwall Replacement & G16 G6A/S6 Access Bridge G93 IT Shelter and Structure Refurbishment Gate/Hydro Cylinder Overhauls (C&SF) Gate/Hydro Cylinder Overhauls (STA) Generator Replacement Program Hoist Conversion Project S179 & future conversions S167 Wingwall Replacement S169W Trash Rake S26 Major Refurbishment S65 Spillway Replacement S65A Spillway Replacement S65D Spillway Replacement S70 Replacement S71 Replacement S49 Replacement STA1W Structure Refurbishments & Replacements STA1E Outflow Structure Generator Addition STA1WE1 Outflow Structures Generator Additions Structure/Bridge Modification/Repair Staff Support

District Resiliency Priority Projects

The list of priority resiliency implementation projects (Table 9-3) is presented below, showing the status of funding and how the project is linked to the District’s mission.

Table 9-3: List of Resiliency Priority Projects showing how the project is linked to the District’s mission as well as implementation and funding status

Project Name	Mission	Source	Status of Implementation	Status of Funding
S-28 Coastal Structure and C-8 Basin Resiliency	Flood Control, Water Supply, Ecosystem Restoration	FPLOS Phase II	Not Started (Conceptual Design Completed)	Partially funded \$50M FEMA BRIC + SFWMD & MDC Match
S-29 Coastal Structure and C-9 Basin Resiliency	Flood Control, Water Supply, Ecosystem Restoration	FPLOS Phase II	Ongoing Design	Design Funds Only (SFWMD)
S-27 Coastal Structure and C-7 Basin Resiliency	Flood Control, Water Supply, Ecosystem Restoration	FPLOS Phase II (Pilot)	Ongoing Design	Design Funds Only (SFWMD)
S-26 Coastal Structure Resiliency	Flood Control, Water Supply	FPLOS Phase I	Not Started	Not yet funded
G-57 Coastal Structure Resiliency	Flood Control, Water Supply	FPLOS Phase I	Not Started	Not yet funded
S-22 Coastal Structure Resiliency	Flood Control, Water Supply	FPLOS Phase I	Not Started	Not yet funded
S-37A Coastal Structure Resiliency	Flood Control, Water Supply	FPLOS Phase I	Not Started	Not yet funded
G-58 Coastal Structure Resiliency	Flood Control, Water Supply	FPLOS Phase I	Not Started	Not yet funded
S-123 Coastal Structure Resiliency	Flood Control, Water Supply	FPLOS Phase I	Not Started	Not yet funded
S-20F Coastal Structure Resiliency	Flood Control, Water Supply	FPLOS Phase I	Not Started	Not yet funded
S-21 Coastal Structure Resiliency	Flood Control, Water Supply	FPLOS Phase I	Not Started	Not yet funded
G-93 Coastal Structure Resiliency	Flood Control, Water Supply	FPLOS Phase I	Not Started	Not yet funded

Project Name	Mission	Source	Status of Implementation	Status of Funding
S-25B Coastal Structure Resiliency	Flood Control, Water Supply	FPLOS Phase I	Not Started	Not yet funded
G-56 Coastal Structure Resiliency	Flood Control, Water Supply	FPLOS Phase I	Not Started	Not yet funded
G-54 Coastal Structure Resiliency	Flood Control, Water Supply	FPLOS Phase I	Not Started	Not yet funded
S-25 Coastal Structure Resiliency	Flood Control, Water Supply	FPLOS Phase I	Not Started	Not yet funded
S-33 Coastal Structure Resiliency	Flood Control, Water Supply	FPLOS Phase I	Not Started	Not yet funded
S-20G Coastal Structure Resiliency	Flood Control, Water Supply	FPLOS Phase I	Not Started	Not yet funded
S-13 Coastal Structure Resiliency	Flood Control, Water Supply	FPLOS Phase I	Not Started	Not yet funded
S-36 Coastal Structure Resiliency	Flood Control, Water Supply	FPLOS Phase I	Not Started	Not yet funded
S-197 Coastal Structure Resiliency	Flood Control, Water Supply	FPLOS Phase I	Not Started	Not yet funded
S-20 Coastal Structure Resiliency	Flood Control, Water Supply	FPLOS Phase I	Not Started	Not yet funded
Remaining Coastal Structures Resiliency	Flood Control, Water Supply	FPLOS Phase I (not yet completed)	Not Started	Not yet funded
L-31 Levee Improvements	Flood Control, Water Supply	FPLOS Phase I	Not Started	Not yet funded
Self-Preservation	Flood Control, Water Supply	CIP/Post Storm	Ongoing Design	Fully Funded \$6.3M FDEP Resilient Florida + SFWMD Match
Hardening Of S-2, S-3, S-4, S-7, S-8 Engine Control Panels	Flood Control, Water Supply	CIP	Ongoing Design & Construction Initiation	Fully Funded \$8.5M FDEP Resilient Florida + SFWMD Match
L8 FEB / G-539 Pump Resiliency Upgrades	Flood Control, Water Supply	CIP	Ongoing Design	Fully Funded \$4M FDEP Resilient Florida + SFWMD Match

Project Name	Mission	Source	Status of Implementation	Status of Funding
Corbett WMA Hydrologic Restoration and Levee Resiliency	Flood Control, Water Supply, Environmental Restoration	Post Storm / Event Response	Ongoing Design	Fully Funded \$7.7M Palm Beach County FDEP RF + SFWMD, ITID, PBC, FWC Match
C-29, C-29A, C-29B and C29C Canal Conveyance Improvements	Flood Control	Post Storm / Event Response	Not Started	Not yet funded
S-59 Structure Enhancement and C-31 Canal Conveyance Improvements	Flood Control	Post Storm / Event Response	Not Started	Not yet funded
S-58 Structure Enhancement and Temporary Pump	Flood Control	Post Storm / Event Response	Not Started	Not yet funded
S-61 Spillway Enhancement and Erosion Control	Flood Control	Post Storm / Event Response	Not Started	Not yet funded
Corbett Levee Water Control Structures	Flood Control	Post Storm / Event Response	Not Started	Not yet funded
Big Cypress Basin Microwave Tower	Flood Control, Water Supply	Post Storm / Event Response	Not Started	Not yet funded
Everglades Mangrove Migration Assessment (EMMA)	Flood Control, Water Supply, Environmental Restoration	Innovative Projects	Not Started (Conceptual Design Completed)	Not yet funded
Mangrove Experimental Manipulation Exercise (MEME)	Flood Control, Water Supply, Environmental Restoration	Innovative Projects	Not Started (Conceptual Design Completed)	Partially funded (SFWMD)
South Miami-Dade Curtain Wall	Flood Control, Water Supply	Innovative Projects	Not Started	Not yet funded
Renewable Energy Projects	Flood Control, Water Supply, Environmental Restoration	Innovative Projects	Not Started	Not yet funded

S-28 Coastal Structure and C-8 Basin Resiliency

This resiliency project is mainly tied to the District’s mission to provide flood control, water supply protection, and ecosystem restoration. An example of a project that is proposing to use a combination of nature-based solutions and gray infrastructure is the District’s C-8 Basin project in Miami-Dade County. The District has been awarded FEMA grant funding to advance flood risk reduction measures in the C-8 Basin, a region of about 270,000 people that covers 28 square miles in the northeastern portion of Miami-Dade County. It is estimated that an additional 70,000 workers, travelers, and visitors are using the area for employment, transportation, and recreation. In addition, 96 critical assets would be protected under the proposed project. These include Airports (1), Faith Based Facilities (38), Fire Stations (6), Hazardous Waste Transport Facilities (3), Heliports (1), Hospitals/Medical Facilities (6), Law Enforcement Centers (6), Public Schools (33). The overall flood protection levels of service will improve, and water supply protection from saltwater intrusion will increase. This means that 13% of the most populous county in Florida will benefit from an increased level of flood protection. The area drained by the C-8 Canal is fully developed with primarily residential and commercial uses. The C-8 Canal is the central flood control feature that receives and conveys basin floodwaters by gravity through the S-28 Coastal Structure to sea.

S-28 is a reinforced concrete, gated spillway, with discharge controlled by two cable-operated, vertical lift gates that are 17.5 feet high by 27.8 feet wide. The structure has a discharge capacity of 3,220 cfs. S-28 is in the City of Miami near the mouth of C-8, about a mile from the shore of Biscayne Bay. S-28 is a gravity structure, and the designed discharge capacity is achieved when the gradient between the head and tailwater is sufficient to pass the flow. The operation of the gates is automatically controlled so that the gate hydraulic operating system opens or closes the gates in accordance with the operational criteria. The S-28 Structure was designed to 1) maintain optimum water control stages upstream in C-8, 2) release the design flood (100 percent of the Standard Project Flood) without exceeding the upstream flood design stage, 3) restrict downstream flood stages and discharge velocities to non-damaging levels, and 4) prevent saltwater intrusion during periods of extreme high flood tides. The impacts of sea level rise at S-28 Coastal Structures are illustrated in

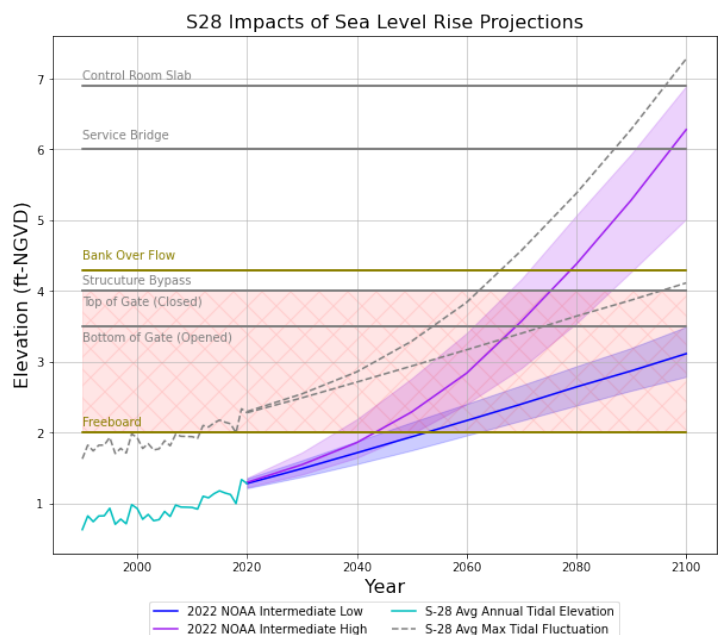

Figure 9-3: S-28 Impacts of Sea Level Rise Projections.

Figure 9-3, demonstrating the risks of saltwater overtopping the gates and minimum freeboard requirements as early as 2040.

Percent of Population Impacted

One hundred percent of the population currently living in the C-8 basin, estimated at 270,000 people, will either directly or indirectly benefit from this project. It is estimated that an additional 70,000 workers, travelers, and visitors using the area for employment, transportation, and recreation. This means that 13% of the most populous county in Florida will benefit from an increased level of protection.

Community-Wide Benefits

Miami-Dade County has been shifting to incorporate a wider range of co-benefits (social, environmental, operational) into their projects to consider equity community-wide. In the context of the proposed project, “community-wide” refers to the historical, cultural, and recreational values that South Florida residents share. This project is aligned with the County’s goals of promoting resilience in a way that goes beyond environmental sustainability (<https://www.miamidade.gov/global/management/strategic-plan/home.page>). The County encourages jurisdictions to take a holistic approach to resilience efforts across four broad dimensions: Leadership and Strategy, Economy and Society, Health and Wellbeing, and Infrastructure and Environment. Their vision is “Delivering excellent service today and tomorrow.” The SFWMD works closely with the County and local jurisdictions to instill these values, particularly with respect to preparing for disasters and extreme events.

Impacts to Lifelines

This project will reduce direct and cascading flood impacts on Community Lifelines, residents, businesses, public services, infrastructure, and natural systems through three key lifelines: Food, Water, Shelter, Transportation, and Energy. Food, Water, Shelter - The proposed project significantly reduces the threat to property. Under the lifeline subcategory of shelter, the project increases the level of protection for over 200,000 primary homes across the area (and nearly 16,000 commercial, industrial, government, education, and religion buildings). Without the project, it would take months for residents whose homes may be significantly damaged to stabilize their living situation. Given the level of damage expected, residents would be displaced while repairs to homes occurred. All of the Village of Miami Shore's single-family homes are on septic tank systems. The septic tank systems east of NE 12th Avenue are particularly vulnerable to sea level rise. In recent years, several properties in the Village have had to retrofit their septic system due to system failure. Alleviation of flooding would minimize future failures.

Transportation

The golf course is bordered by Biscayne Blvd (U.S. Highway 1) to the east. This road is a key evacuation route and connector for the region. The project would alleviate flooding and allow this main artery to flow during extreme events.

Safety and Security

In addition, 96 critical assets would be protected under the proposed project. These include Airports (1), Faith Based Facilities (38), Fire Stations (6), Hazardous Waste Transport Facilities (3), Heliports (1), Hospitals/Medical Facilities (6), Law Enforcement Centers (6), and Public Schools (33). The overall flood protection levels of service will improve, and water supply protection from saltwater intrusion will increase. The proposed project removes a portion of utility infrastructure from the floodplain.

Impacts to Disadvantaged Communities

According to ACS Census, approximately 19% of the population living in the C-8 basin is considered financially disadvantaged. The CDC Social Vulnerability Index shows the census tracts to the north of the project area are in the highest vulnerability ranking. The proposed project has positive direct and indirect (ancillary) impacts related to risk reduction, which will benefit these vulnerable communities. The project will improve existing open space amenities, provide regional flood resilience, and leverage public investment in ongoing resiliency efforts through coordination with local partners. Ancillary impacts of the proposed green infrastructure will improve water quality, air quality, habitat creation, economic opportunity, reduced social vulnerability, cultural resources, public health, and mental health. These benefits are mainly related to flood risk reduction measures, environmental benefits, and the opportunities created for recreation and development.

Project Scope

This project will reduce flood risk under sea-level rise and provide ancillary water quality benefits by restoring the basin's flood protection level of service and enhancing the quality of life in the region. The project includes:

FPLOS Phase II Recommendations:

- S-28 Costal Structure Replacement: replacing major components of the S-28 Structure with a new elevated, gated, water control structure. Converting the gate opening system to a more robust mechanism, replacing the existing gates with corrosion-resistant stainless-steel gates and increased height, replacing the control building with a hardened and elevated control building, and adding a corrosion control system to the structure.

- **Forward Pump:** building a new 2550 cfs forward pump station that will convey flood waters to tide when downstream water elevations are too high to allow gravity flow. The design of the proposed forward pump station will be adaptable and will include the ability to add additional pumps in the future as conditions continue to change.
- **Tie Back Levee:** Constructing a tie-back levee to provide flood and storm surge protection and supporting the required function of the spillway gates and pump during a 100-year event with a three-foot sea level rise.
- **Canal Improvements:** including improving geometry, widening, elevating, and enhancing canal banks throughout the basin, including the S-28 Coastal Structure immediate of C-8 Canal, as well as the most vulnerable locations along the secondary system (Marco Canal, NW 17 AVE Canal, Red Road/NW 57 AVE Canal, Spur #4 Canal, Spur Canal, Upper Rio Vista Canal), in partnership with Miami-Dade county.
- **Storage:** Adding approximately 250-acre feet of distributed storage in the C-8 Basin.
- **Additional stormwater green infrastructure project components:**
- **Building vegetated berms and constructing a temporary impoundment** to reduce runoff, therefore reducing peak flood elevations by storing water on the Miami Shores Golf Course during extreme events until canal elevations subside, allowing the impoundment to drain slowly and including a gated culvert to connect the detention area to the C-8 Canal. Beneficial reuse of excavated sediments from ditches/ponds to build levees and berms.
- **Installing living shoreline features** to assist in reducing bank erosion and improve aesthetics and storm resiliency. Ancillary benefits include the creation of aquatic habitat and water quality benefits, which will increase recreational value in the project area (kayaking, canoeing, wildlife observation, and fishing).

Adaptation and Mitigation Study for the C-8 Basin

The proposed C-8 Basin Resiliency Project was advanced following the completion of flood vulnerability assessments and findings of a need for a major refurbishment of the S-28 Structure through the Structure Inspection Program. The project, a no-regret strategy at the time of its inception, is currently in design.

The recently completed comprehensive study of the C-8 basin (FPLOS Phase II Studies in the C-8 and C-9 Basins, 2023) confirmed the C-8 Basin project elements, evaluated the potential downstream impacts and water quality impacts to Biscayne Bay, and identified additional adaptations necessary to achieve flood risk reduction and resiliency within the C-8 Basin. The study, completed in collaboration with water managers of the secondary and tertiary flood control system, identified and recommended sequencing for the implementation of the project. The M2B implementation strategy is being recommended for near-term

implementation, and M2C for longer-term implementation, addressing flood risks resulting from more than 2 feet of sea level rise. Table 9-4 illustrates which project components were recommended as part of each implementation strategy. The M2C features, once implemented, will achieve a level of service equal to or greater than the existing conditions under the 25-year SLR0 event for the 25-year SLR3 scenario. In addition to these regional project features, there are local projects that will be developed in partnership with local partners – at secondary and tertiary systems.

Table 9-4: FPLOS Phase II project component recommendations for the C-8 Basin

FPLOS Recommendation	M2A	M2B	M2C
<ul style="list-style-type: none"> • Forward pump station at S-28 Structure location 	1550 cfs	2550 cfs	3550 cfs
<ul style="list-style-type: none"> • Tidal structure improvements and tieback levees/floodwalls 	x	x	x
<ul style="list-style-type: none"> ▪ Canal improvements (raised bank elevations) 		x	x
<ul style="list-style-type: none"> ▪ Canal improvements (Improved canal geometry) 		x	x
<ul style="list-style-type: none"> ▪ Canal improvements (Canal widening) 			x
<ul style="list-style-type: none"> ▪ 250 acre-feet of distributed storage 		x	x

Reducing Risk and to What Level

The proposed project consists of local and regional flood mitigation strategies that reduce flood risk and enhance resiliency. These mitigation strategies will increase the effective resilience of the entire C-8 Basin. A range of critical assets, including fire stations, emergency shelters, and medical facilities, support several Community Lifelines and a variety of cultural, historical, and environmental resources in the basin. Additionally, the County has a high Building Code Effectiveness Grading Schedule (BCEGS) score of 2, which shows a commitment to reducing risk through strong building code adoption and enforcement activities. Extensive land development and population increases within the basin have already exceeded the original design assumptions of the C-8 Canal and S-28 Structure. Significant changes in climate conditions and sea level rise have also impacted the project and are limiting flood protection operations. These risks and their potential impacts are multifaceted and involve flood hazards driven by storm surges, high tides, and extreme rainfall.

Increase Resilience

A significant aspect of this project includes using a portion of the Miami Shores Golf Course as a temporary flood water storage area during extreme rain and storm surge events. Vegetated berms and living shoreline features are also incorporated into the conceptual plan to enhance water quality and aquatic habitat. The strategy to reduce runoff in this densely urbanized basin includes the implementation

of a series of distributed storage solutions. These project features can serve as a pilot example regionally, as nearby jurisdictions are looking to implement similar measures.

Ancillary Benefits

Ancillary benefits include improved fish and wildlife habitat from the implementation of the living shoreline features, improved land value due to reduced flood risk and enhanced aesthetics, prevention of canal bank erosion, water quality benefits from the implementation of vegetated berms and temporary flood water storage on the golf course and increased opportunities for recreation. SFWMD aims to improve the C-8 Basin's water quality and ecological functions beyond enhancing the flood protection level of service while maximizing the risk reduction benefits and co-benefits of natural and nature-based solutions, such as short- and long-term environmental, economic, and social advantages that improve a community's quality of life and make it more attractive to new residents and businesses.

Leveraging Innovation

This project will introduce green infrastructure features that have not been used previously in this area. While Miami-Dade County is eager to pilot linear parks, living shorelines, and expand Greenways and Blueways, this project will be the first opportunity in this basin. The County conducted stakeholder engagement to share the approaches and gather feedback. The community most enthusiastically supported the green infrastructure approaches.

Outreach Activities

A comprehensive public outreach process is embedded in the SFWMD Sea Level Rise and Flood Resiliency Plan – Annual Update and the Flood Protection Level of Service Program (FPLOS), along with the and the Miami-Dade Sea Level Rise Strategy, to ensure equal opportunity for South Florida communities to participate in the planning and decision-making process. The FPLOS Phase II Studies' initial round of workshops and meetings are designed to obtain local project data and information about community needs, promoting coordination and collaboration with partner agencies and local communities. The closing workshops and outreach efforts are designed to provide stakeholders with helpful planning tools and cost-effective courses of action for prioritizing and designing projects in the secondary and tertiary systems and inform the community about the impacts of flooding and the benefits of the adaptation and mitigation projects identified. This process was recently completed at the [C-8 Basin](#), and the project site (<http://www.buildcommunityresilience.com/SFWMD/FPLOS/c8c9/>) was used as a tool to collect information and feedback from community partners and make outreach materials available.

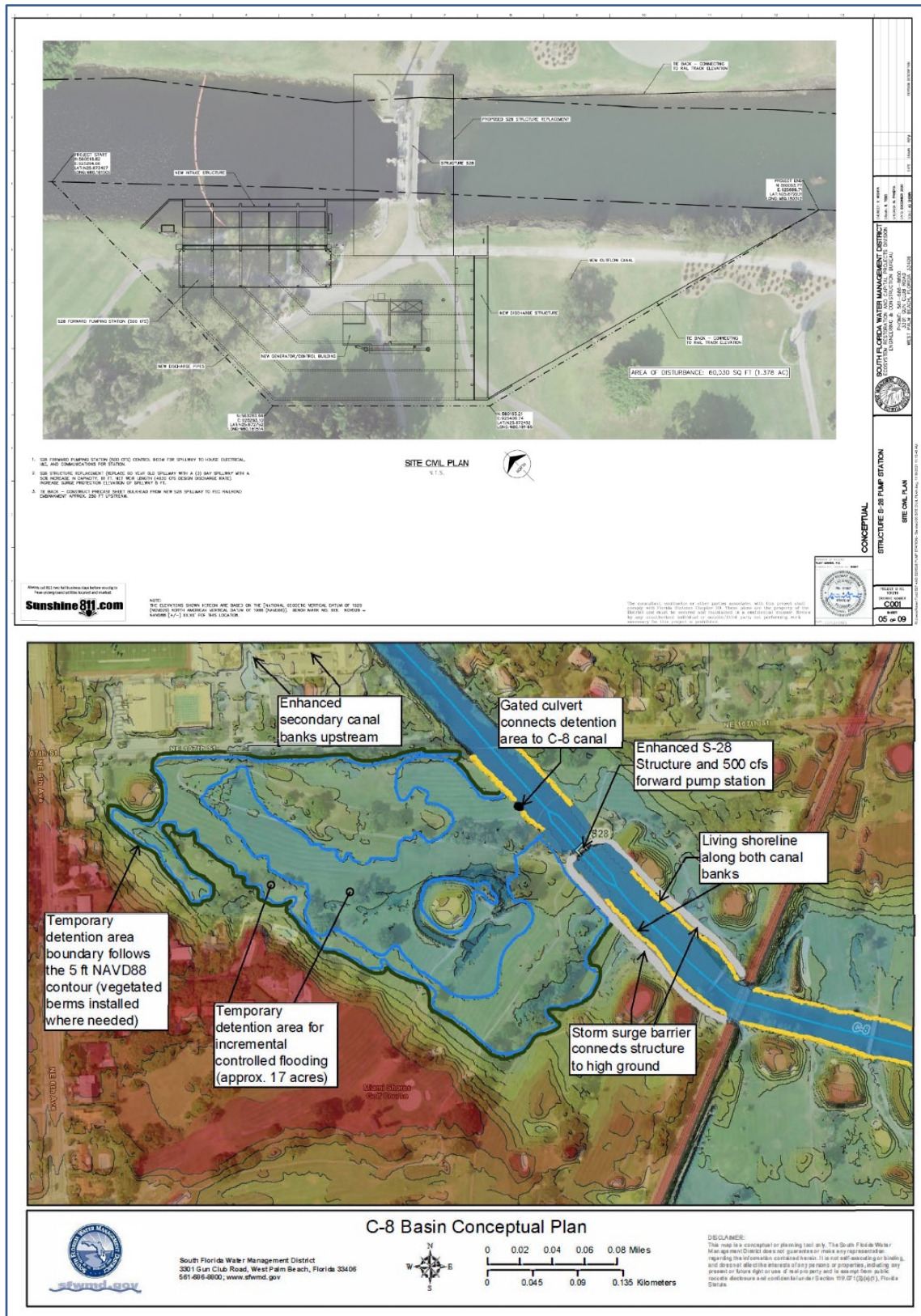

Figure 9-4: Site plan for S-28 Structure features and conceptual plan for the C-8 Basin.

A significant aspect of this project includes using a portion of the Miami Shores Golf Course as a temporary flood water storage area during extreme rainfall and storm surge events (Figure 9-4 above). Vegetated berms and living shoreline features are also incorporated into the plan to enhance water quality and aquatic habitat. The strategy to reduce runoff in this densely urbanized basin includes the implementation of a series of distributed storage solutions. These project features can serve as pilot project examples for the region. Ancillary benefits include improved fish and wildlife habitat from the implementation of the living shoreline features, improved land value due to reduced flood risk and enhanced aesthetics, prevention of canal bank erosion, water quality benefits from the implementation of vegetated berms and temporary flood water storage and increased opportunities for recreation.

A total cost estimate to harden the S-28 Coastal Structure to address flooding, sea level rise, and other related risks to vulnerable communities in the C-8 Basin is presented below, and it includes modifications to the existing structure and control building, the addition of a forward pump and construction of flood barriers. The additional pumping capacity will extend the conveyance performance for additional years as sea level rises, delay out-of-bank flooding, and reduce canal peak stages. Additional potential funds to purchase real estate for the project are included, and negotiations with the landowner will initiate upon funding confirmation.

C-8 Basin Cost Estimate

Structure Enhancement and Pump Station (M2B)	
S-28 Structure Replacement	\$ 16,618,031
Forward Pump (2550 cfs)	\$ 107,002,000
Forward Pump Backup Generator Facility	\$ 11,440,000
Structure Tie Back (Flood Barrier)	\$ 2,987,000
Design & Construction Management	\$ 21,073,000
Real Estate	\$ 7,000,000
Total Pump Station Cost	\$ 166,120,031
Storage (M2B)	
Distributed Storage (~250 Acre-Ft)	\$ 38,860,000
Design & Construction Management	\$ 5,829,000
Total Storage Cost	\$ 44,689,000
Canal Improvements (M2C)	
Raise Canal Banks (to 7.5 feet NGVD29)	\$ 12,413,000
Widen Canal (approx. 20,000 linear feet by 100 feet)	\$ 31,619,000
Design & Construction Management	\$ 6,605,000
Total Canal Improvements Cost	\$ 50,637,000
Stormwater Green Infrastructure / nature-based solutions (BRIC Application)	
Temporary Impoundment, Vegetative Berms, and Living Shoreline	\$ 1,500,000
Total Cost Estimate for C-8 Basin	\$ 261,446,031

Note: The cost assumptions for the FPLOS Phase II M2 Alternatives are planning level estimates and will be refined as the project designs advance.

S-29 Coastal Structure and C-9 Basin Resiliency

This resiliency project is mainly tied to the District’s mission to provide flood control, water supply protection, and ecosystem restoration. This project proposes flood risk reduction measures for the C-9 Basin, a region of about 549,964 people (Census Tracts, 2022), encompassing 100 square miles, located in the

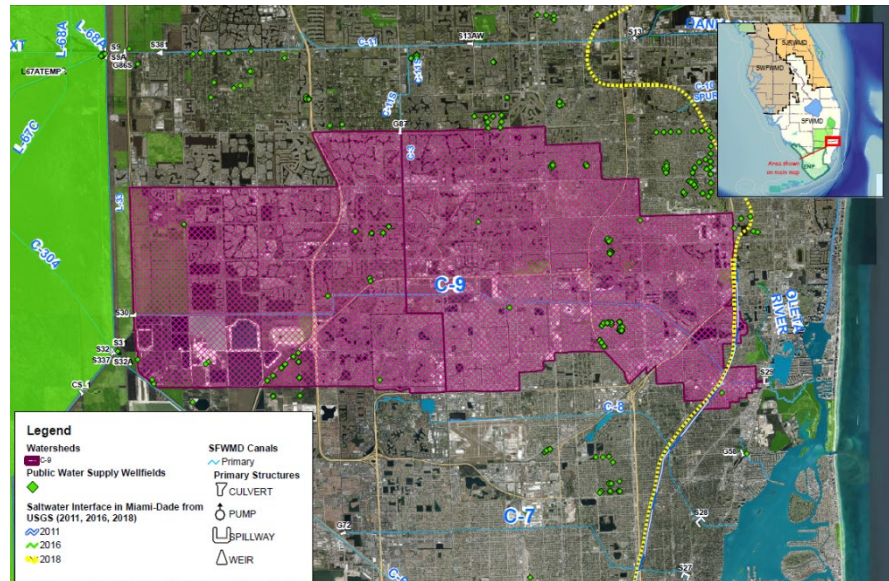

Figure 9-5: Map of C-9 Basin

southern portion of Broward County and northeastern portion of

Miami-Dade County (Figure 9-5). The basin area is fully developed with primarily residential and commercial uses. The C-9 Canal and the S-29 Coastal Structure are the primary flood control features of this basin. The C-9 Canal receives and conveys flood waters by gravity through the S-29 Coastal Structure to the Oleta River (tide). The S-29 Coastal structure is a reinforced concrete, gated spillway with discharge controlled by four cable-operated vertical lift gates with a discharge capacity of 4,780 cfs. The S-29 Structure is located near the mouth of the C-9 Canal, in an urbanized area of North Miami Beach east of Biscayne Boulevard and just north of Northeast 165th Terrace. The structure controls fresh water flows out

of the C-9 Canal into the Oleta River and drains the C-9 East and C-9 West watersheds. The C-9 Canal extends approximately 19.5 miles east from the L-33 Canal adjacent to Water Conservation Area 3B and the lake belt region before traversing the densely populated area between Miramar to the north and Miami Gardens to the south. The canal drainage area is developed with a mixture of

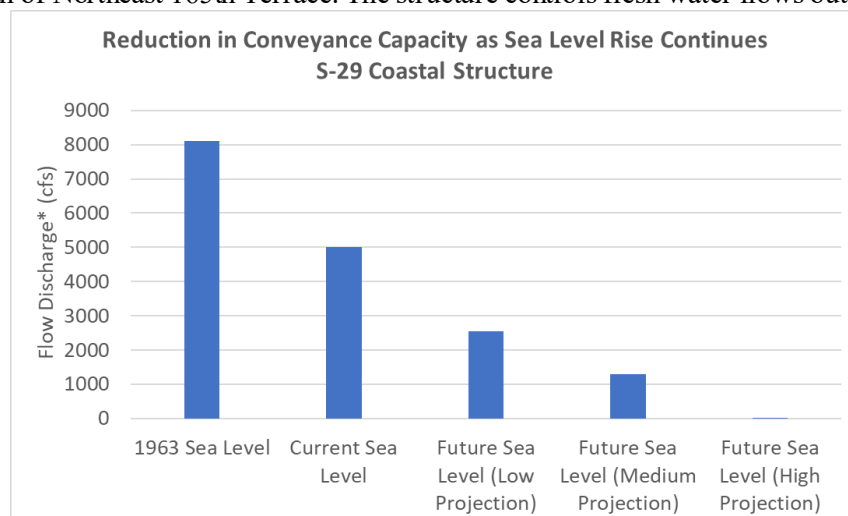

Figure 9-6: Reduction in conveyance capacity at S-29 as SLR continues.

commercial structures along Biscayne Boulevard, high-rise residences immediately to the east, and a public park to the north. The S-29 Structure was originally designed by the U.S. Army Corps of Engineers (USACE) as part of the Central and Southern Florida (C&SF) Project with the objective of providing flood control and preventing saltwater intrusion. The C&SF Project was authorized in 1948 and was constructed by the USACE between 1950 and 1970. S-29 is a gravity structure, and the designed discharge capacity is achieved when the gradient between the head and tailwater is sufficient to pass the flow. Operation of the gates is automatically controlled so that the gates open or close in accordance with the seasonal operational criteria. The structure's original design did not account for the sea level rise of the magnitudes that are being experienced today along the coastline of South Florida. Figure 9-6 illustrates the impacts of sea level rise on conveyance capacity at the S-29 structure over time.

Percent of Population Impacted

One hundred percent of the population currently living in the C-9 basin, estimated at 549,964 people (2022 Census), will either directly or indirectly benefit from this project. The overall flood protection levels of service and water supply protection from saltwater intrusion are expected to improve. Flood modeling results from the C-9 Basin Flood Protection Level of Service Study, as detailed here, demonstrate basin-wide benefits.

Community-Wide Benefits

SFWMD, Broward, and Miami-Dade County have been shifting to incorporate a wider range of co-benefits (social, environmental, operational) into their projects to consider equity community-wide. In the context of the proposed project, “community-wide” refers to the historical, cultural, and recreational values that South Florida residents share. This project is aligned with [Miami-Dade County's goals](#) of promoting resilience in a way that goes beyond environmental sustainability.

Miami-Dade County encourages jurisdictions to take a holistic approach to resilience efforts across four broad dimensions: Leadership and Strategy, Economy and Society, Health and Wellbeing, and Infrastructure and Environment. Their vision is “Delivering excellent service today and tomorrow.” The SFWMD, as the agency responsible for the primary water control system, works closely with the County and local jurisdictions to instill these values, particularly with respect to preparing for disasters and extreme events.

Impacts to Lifelines

This project will reduce direct and cascading flood impacts on Community Lifelines, residents, businesses, public services, infrastructure, and natural systems through three key lifelines: Food, Water, Shelter, Transportation, and Energy. Food, Water, Shelter. The proposed project significantly reduces the

threat to property. Under the lifeline subcategory of shelter, the project increases the level of protection for over 177,621 primary homes across the area. Without the project, it would take months for residents whose homes may be significantly damaged to stabilize their living situation. Given the level of damage expected, residents would be displaced while repairs to homes occurred. Many of the basin's single-family homes are on septic tank systems. The septic tank systems east of I95 are particularly vulnerable to sea level rise. In recent years, several properties in this basin have had to retrofit their septic system due to system failure. Alleviation of flooding would minimize future failures.

Transportation

The S-29 Structure is bordered by Highway U.S.1 to the west and SR826 to the south. These roads are key evacuation routes and connectors for the region. The project would alleviate flooding and allow these main arteries to function and be more easily accessible during extreme events.

Safety and Security

In addition, 162 critical assets would be protected under the proposed project. These include Airports (5), Fire Stations (19), Hazardous Waste Transport Facilities (2), Heliports (3), Hospitals/Medical Facilities (17), Law Enforcement Centers (6), and Public Schools (110). The overall flood protection levels of service will improve, and water supply protection from saltwater intrusion will increase. The proposed project removes a portion of utility infrastructure from the floodplain.

Impacts to Disadvantaged Communities

To ensure forty percent (40%) of the overall project benefits flow to disadvantaged communities that are marginalized, underserved, and overburdened by environmental stressors, the District relies on data available through the Climate and Economic Justice Screening Tool (CEJST) and the Centers for Disease Control and Prevention (CDC) Agency for Toxic Substances and Disease Registry (ATSDR) Social Vulnerability Index (SVI). Based on these data, fifty-seven percent (57%) of the population within the project impact area were identified as socioeconomically disadvantaged and will receive equal access to community-wide benefits from the implementation of this resiliency project. These benefits are mainly related to flood risk reduction measures, environmental benefits, and the opportunities created for education, recreation, and development.

The CEJST identifies twenty-five percent (25%) of the population within the project impact as disadvantaged under the Climate Change category. The climate change category quantifies and considers the percent low-income population and higher education non-enrollment as well as expected population, building, and agricultural loss rates above pre-determined thresholds.

The CDC identifies twenty-seven percent (27%) of the population within the project impact areas as having an SVI greater than 0.8 or higher, the highest vulnerability ranking, and thirty percent (30%) of the population within the project impact area as having an SVI between 0.6 and 0.8, the second highest vulnerability ranking. The CDC/ATSDR SVI ranks each census tract on 16 social factors, including poverty, lack of vehicle access, and crowded housing, and groups them into four related themes.

Project Scope

The proposed project consists of flood mitigation and enhancement strategies at the C-9 Basin to build flood resiliency and increase protection against saltwater intrusion. Specifically, the project includes:

FPLOS Phase II Recommendations:

- **S-29 Coastal Structure Enhancement:** converting the gate opening system to a more robust mechanism, upgrading the existing gates to elevated, corrosion-resistant stainless-steel gates and enhancing, elevating, and hardening the control building, and adding a corrosion control system to the structure.
- **Forward Pump:** building a new 2550cfs forward pump station that will convey flood waters to tide when downstream water elevations are too high to allow gravity flow. The design of the proposed forward pump station will be adaptable and will include the ability to add additional pumps in the future as conditions continue to change.
- **Tie Back Levee:** Construct a tie-back levee/salinity barrier to provide flood and storm surge protection and support the required function of the spillway gates and pump during a 100-year event with a three-foot sea level rise.
- **Canal Improvements:** raising canal bank elevations, improving geometry, and widening. A portion of approximately 7 miles of the C-9 Canal is being widened to include nature-based solutions enhancement along canal banks (more details provided in the subsection below)
- **Storage:** Adding approximately 250-acre feet of distributed storage in the C-9 Basin.
- **Additional stormwater green infrastructure project components:**
- **Enhancing an approximately 16-acre flow-through wetland/stormwater detention area at Pickwick Lake (Figure 9-7),** which is owned by the City of North Miami Beach, to reduce local runoff in the area. The stormwater detention area will incorporate Biosorption Activated Media (BAM), an innovative stormwater best management practice in South Florida that has been deployed across agencies and in varied use cases and has consistently reduced harmful nutrients such as nitrogen and phosphorus, and other contaminants in stormwater.

- Installing 1,850 linear feet of living shoreline to assist in reducing bank erosion and improve aesthetics and storm resiliency. In addition, a shaded gathering area, educational signage, and other amenities to help increase community engagement and public use will be incorporated into the project.

Adaptation and Mitigation Study for the C-9 Basin

The proposed C-9 Basin Resiliency Project was advanced following the completion of flood vulnerability assessments and findings of a need for a major refurbishment of the S-29 Structure through the Structure Inspection Program. The project, a no-regret strategy at the time of its inception, is currently in design. The recently completed comprehensive study of the C-9 basin (FPLOS Phase II Studies in the C-8 and C-9 Basins, 2023) confirmed the C-9 Basin project elements, evaluated the potential downstream impacts and water quality impacts to Biscayne Bay, and identified additional adaptations necessary to achieve flood risk reduction and resiliency within the C-9 Basin. The study, completed in collaboration with water managers of the secondary and tertiary flood control system, identified and recommended sequencing for implementation of the project. The M2B implementation strategy is being recommended for near-term implementation, and M2C for longer-term implementation, addressing flood risks resulting from more than 2 feet of sea level rise. Table 9-5 illustrates which project components were recommended as part of each implementation strategy. The study recommended that features of the M2C scenario, such as the canal widening, be opportunistically implemented to deliver immediate water quality and other social benefits along with flood risk reduction. The M2C features, once implemented, will achieve a level of service equal to or greater than the existing conditions under the 25-year SLR0 event for the 25-year SLR3 scenario. In addition to these regional project features, there are local projects that will be developed in partnership with local partners – at secondary and tertiary systems.

Table 9-5: FPLOS Phase II project component recommendations for the C-9 Basin.

FPLOS Recommendation	M2A	M2B	M2C
• Forward pump station at S-29 Structure location	1550 cfs	2550 cfs	3550 cfs
• Tidal structure improvements and tieback levees/floodwalls	x	x	x
▪ Canal improvements (raised bank elevations)		x	x
▪ Canal improvements (Improved canal geometry)		x	x
▪ Canal improvements (Canal widening)			x
▪ 250 acre-feet of distributed storage		x	x



Figure 9-7: Pickwick Lake wetland restoration/stormwater detention area features.

Reducing Risk and to What Level

Extensive land development and population increases within the basin have already exceeded the original design assumptions of the C-9 Canal and S-29 Structure. Significant changes in climate conditions and sea level rise have also impacted the area and are limiting flood protection operations. These risks and their potential impacts are multifaceted and involve flood hazards driven by storm surges, high tides, and extreme rainfall. This project will reduce flooding risk by reducing peak canal stages, bank exceedances, and overland flood inundation throughout the C-9 Basin for the 5-year, 10-yr, 25-yr, and 100-yr extreme storm events and under 1ft, 2ft, and 3ft sea level rise scenarios, as demonstrated by hydrology and hydraulics model simulations. The project consists of local and regional flood mitigation strategies that reduce flood risk and enhance resiliency. These mitigation strategies will increase the resilience of the entire C-9 Basin. A range of critical assets, including fire stations, emergency shelters, and medical facilities, support several Community Lifelines and a variety of cultural, historical, and environmental

resources in the basin. Additionally, the County has a high Building Code Effectiveness Grading Schedule (BCEGS) score of 2, which shows a commitment to reducing risk through strong building code adoption and enforcement activities.

Increase Resilience

The project components to increase resilience include enhancements to the S-29 Structure and the addition of a forward pump and a tie-back levee. The pump will maintain basin discharge capacity while sea levels rise. The new levee and increased elevation of the flood control gates and service bridge will help prevent overtopping and reduce saltwater intrusion risk. A significant aspect of this project includes the construction of demonstration-level nature-based features at Pickwick Lake in partnership with the City of North Miami Beach. These proposed components include enhancing a 16-acre flow-through wetland/stormwater detention area and installing a living shoreline to reduce bank erosion, and indirectly enhancing water quality and aquatic habitat. The overall strategy to reduce runoff in this densely urbanized basin includes the implementation of a series of distributed storage solutions. This project can serve as an example regionally, as nearby jurisdictions are looking to implement similar measures. Elevation of secondary canal banks and construction of sluice gates with green retaining walls will also help to reduce flooding impacts and increase resilience in the basin.



Figure 9-8: Site plan at S-29 Structure.

Ancillary Benefits

Beyond enhancing the flood protection level of service, the project aims to maximize the risk reduction benefits and co-benefits of nature-based solutions and improve the C-9 Basin's water quality and ecological functions. Benefits include short and long-term environmental, economic, and social advantages that improve a community's quality of life, emphasize community engagement, and increase recreational value in the project area (kayaking, canoeing, wildlife observation, and fishing). Ancillary benefits also include improved fish and wildlife habitat from the implementation of the living shoreline features, improved land value due to reduced flood risk and enhanced aesthetics, prevention of canal bank erosion, water quality benefits from the implementation of the flow-through wetland/stormwater detention area and increased opportunities for recreation.

Leveraging Innovation

This project will introduce green infrastructure features that have not been used previously in this area. While Miami-Dade County is eager to pilot linear parks, living shorelines, and expand Greenways and Blueways, this project will be the first opportunity in this basin. The County conducted stakeholder engagement to share the approaches and gather feedback. The community most enthusiastically supported the green infrastructure approaches.

Outreach Activities

A comprehensive public outreach process is embedded in the SFWMD Sea Level Rise and Flood Resiliency Plan – Annual Update and the Flood Protection Level of Service Program (FPLOS), along with the and the Miami-Dade Sea Level Rise Strategy, to ensure equal opportunity for all members of South Florida communities to participate in the planning and decision-making process. The FPLOS Phase II Studies’ initial The initial round of workshops and meetings are designed to obtain local project data and information about community needs, promoting coordination and collaboration with partner agencies and local communities. The closing workshops and outreach efforts are designed to provide stakeholders with helpful planning tools and cost-effective courses of action for prioritizing and designing projects in the secondary and tertiary systems and inform the community about the impacts of flooding and the benefits of the adaptation and mitigation projects identified. This process was recently completed at the C-9 Basin, and the project site (17) was used as a tool to collect information and feedback from community partners and make outreach materials available.

C-9 Basin Cost Estimate

Structure Enhancement and Pump Station (M2B)	
S-29 Structure Refurbishment	\$12,856,352
Forward Pump (2550 cfs)	\$111,669,000
Forward Pump Backup Generator Facility	\$11,919,000
Structure Tie Back (Flood Barrier)	\$2,769,000
Design & Construction Management	\$21,812,000
Real Estate	\$16,000,000
Total Pump Station Cost	\$177,025,352
Storage (M2B)	
Distributed Storage (~250 Acre-feet)	\$38,860,000
Design & Construction Management	\$5,829,000
Total Storage Cost	\$44,689,000
Canal Improvements (M2C)	
Raise Canal Banks (to 7.5 feet NGVD29)	\$7,119,000
Widen Canal (approx. 40,000 linear feet by ~40-50 feet, with nature-based solutions enhancements along the canal bank)	\$53,860,000
Widen Canal (approx. 40,000 linear feet by 75 feet)	\$53,860,000
Design & Construction Management	\$17,227,000
Total Canal Improvements Cost	\$132,066,000
Stormwater Green Infrastructure / nature-based solutions (BRIC Proposal)	
Pickwick Lake and Living Shoreline	\$1,500,000
Total Cost Estimate for C-9 Basin	\$355,280,352

Note: The cost assumptions for the FPLOS Phase II M2 Alternatives are planning level estimates and will be refined as the project’s designs advance.

C-9 Canal Widening and Enhancement with Nature-Based Features

The FPLOS study results for the C-9 Basin recommended widening a portion of the C-9 Canal to enhance conveyance and storage capacity. This project was identified as a future need within the basin. Due to the opportunity to provide co-benefits (social environmental and water quality) along with flood risk reduction, the project was recommended for opportunistic implementation where conditions such as right of way and land ownership allow. Adding a forward pump station at the S-29 Structure increased the level of service. However, constrictions in the western portion of the canal limit the effectiveness of the forward pump station. The full level of service improvements was found to be achievable by installing a forward pump station at the S-29 Structure and widening a portion of the canal (40-75) feet wider depending on the section. This component of the C-9 resiliency project includes the following features:

- Widening approximately seven miles of the C-9 Canal to increase storage and conveyance capacity.
- Constructing a mosaic of ecotones (wetland, terrestrial, and aquatic, depending on topography) adjacent to the C-9 Canal. A combination of features such as constructed wetlands, living shoreline, bioswales, and vegetated buffers will be used to increase flood resilience, create additional stormwater storage, restore floodplain connectivity, reduce erosion of the canal banks, enhance water quality, and increase fish and wildlife habitat. Increased evapotranspiration in the constructed wetland can contribute to reductions in peak flood stages and durations.
- Constructing access roads along the banks of the C-9 Canal to improve operations and maintenance of the canal as well as increase the potential for public access for recreational purposes.
- Connecting the wetland to the C-9 Canal using gated culverts, low water crossings, etc. This will increase floodplain connectivity, increase the ability to store water, improve water quality, including dissolved oxygen levels, and improve fish and wildlife habitat.
- Constructing structural or nature-based measures at the outfalls of 8-10 secondary canals to treat runoff before it enters the C-9 Canal and improve basin resiliency.
- Constructing temporary pump pads at secondary canal outfalls. The pads would make it easier to deploy temporary pumps during and after extreme events.

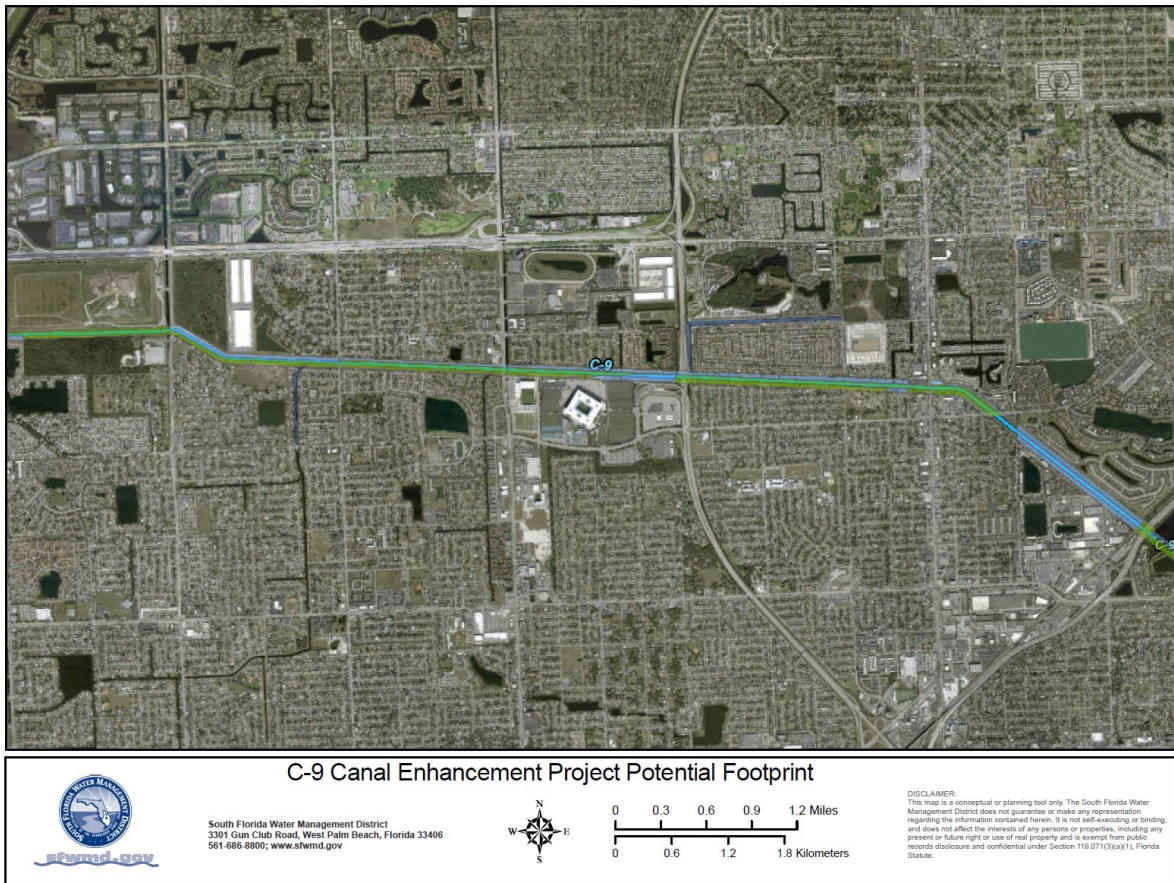

Figure 9-9: Potential project footprint for C-9 Enhancement project.

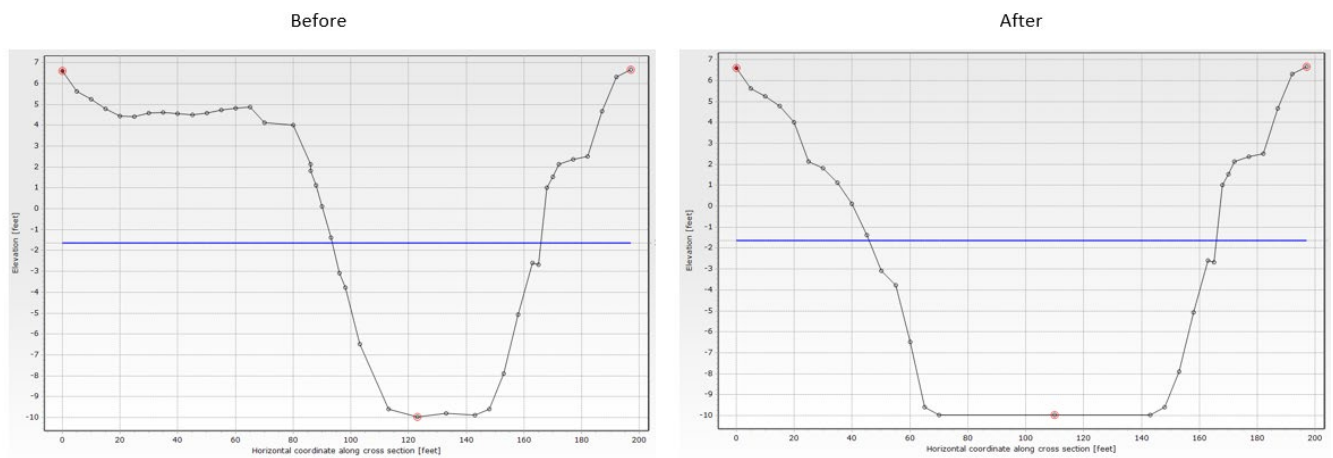

Figure 9-10: Typical canal cross-section before and after widening.

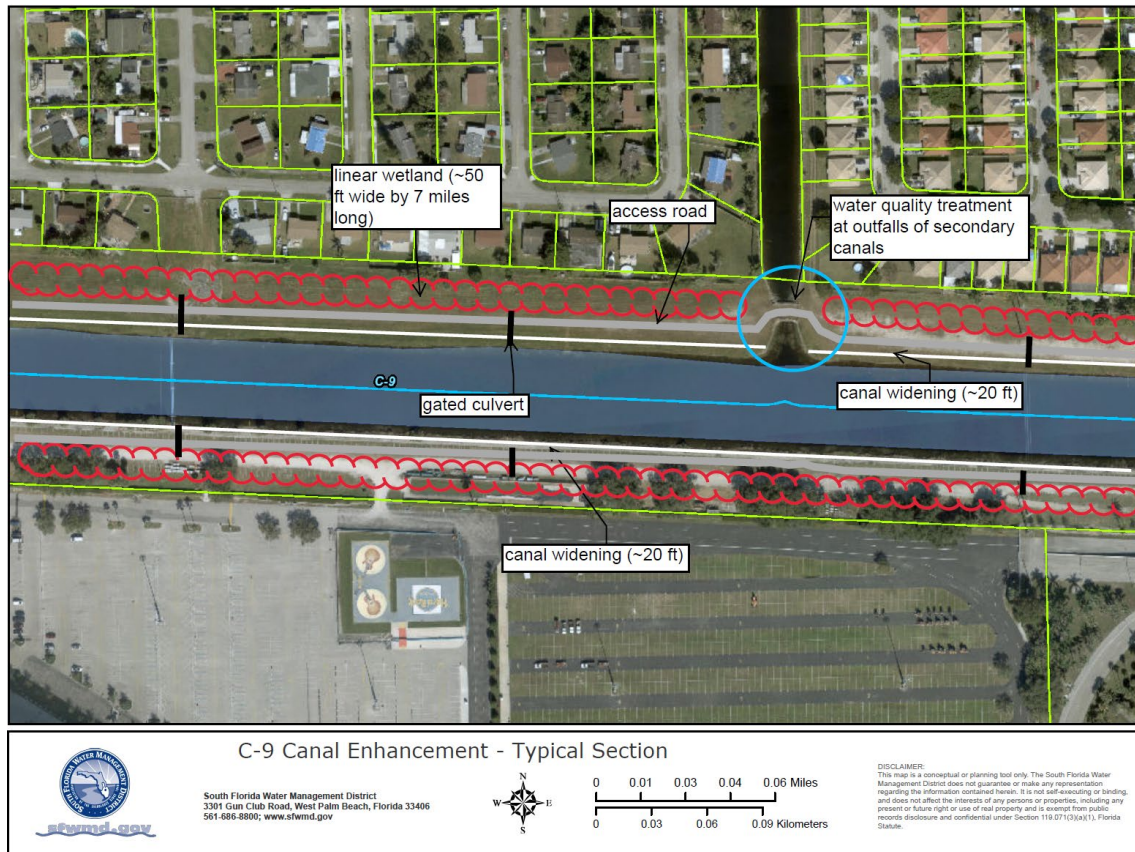

Figure 9-11: Typical section of the C-9 Canal Enhancement project showing potential project features

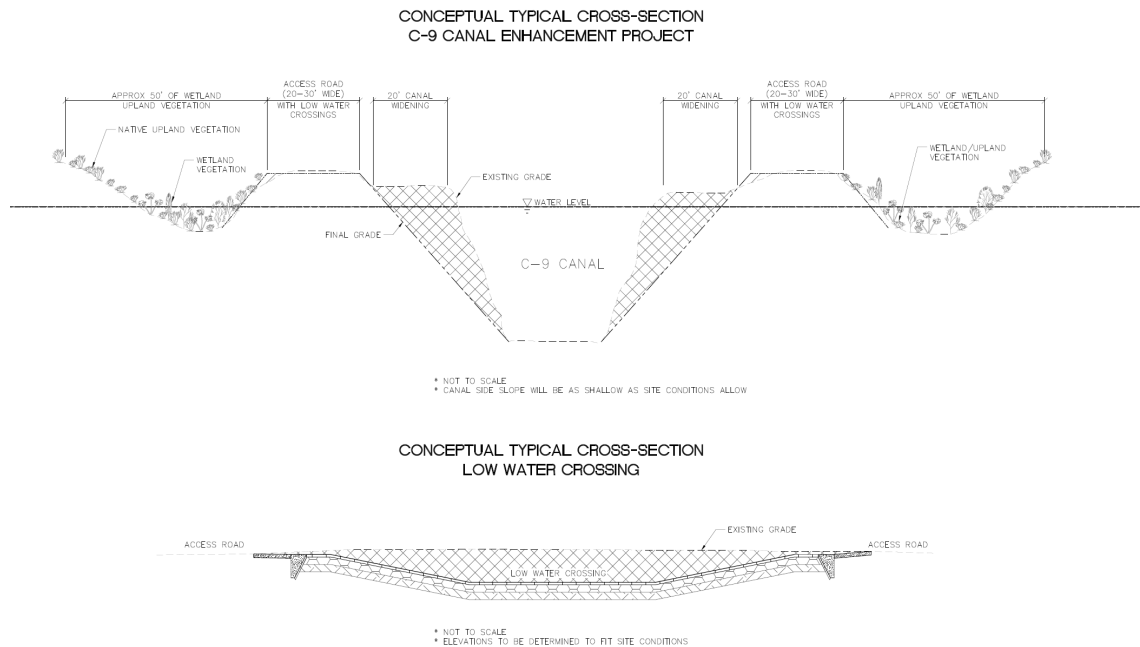

Figure 9-12: Typical cross-section of the C-9 Canal Enhancement project showing potential project features

S-27 Coastal Structure and C-7 Basin Resiliency

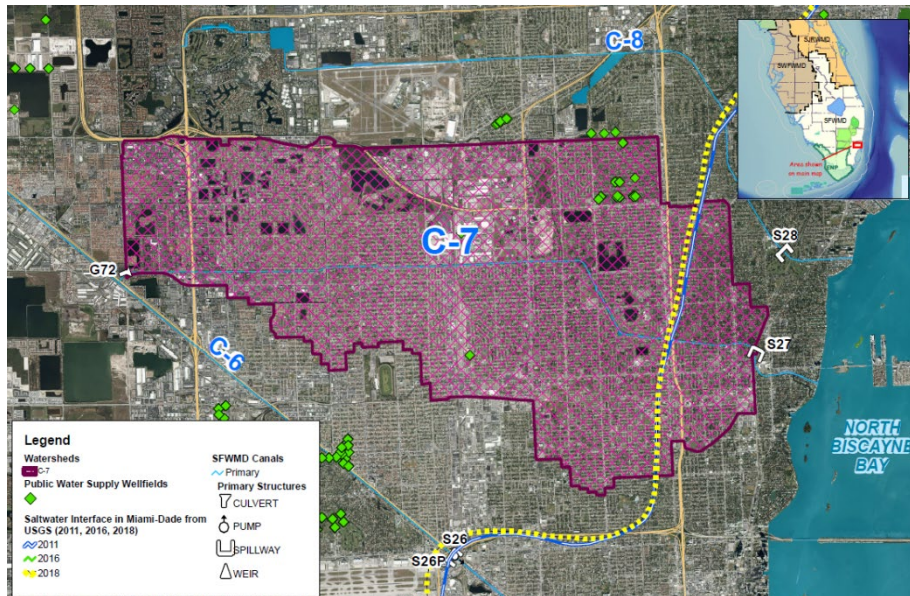

Figure 9-13: Map of C-7 Basin.

This resiliency project is mainly tied to the District’s mission to provide flood control, water supply protection, and ecosystem restoration. S-27 is a reinforced concrete, gated spillway, with discharge controlled by two vertical lift gates with a discharge capacity of 2,800 cfs. S-27 is a gravity structure, and the designed

discharge capacity is achieved when the gradient between the head and tailwater is sufficient to pass the flow. The operation of the gates is automatically controlled. The structure is in the City of Miami near the mouth of the C-7 Canal, about 700 feet from the shore of Biscayne Bay. The C-7 Basin has a population of about 270,000 people within 32 square miles in the northeastern portion of Miami-Dade County (Figure 9-13). The area drained by the C-7 Canal is fully developed with primarily residential and commercial uses. The C-7 Canal is the central flood control feature that receives and conveys basin flood waters by gravity through the S-27 Coastal Structure to sea. This structure was designed to 1) maintain optimum water control stages upstream in C-7 (Little River Canal), 2) release the design flood (75 percent of the Standard Project Flood) without exceeding the upstream flood design stage, 3) restrict downstream flood stages and discharge velocities to non-damaging levels, and 4) prevent saltwater intrusion during periods of high tides.

Percent of Population Impacted

One hundred percent of the population currently living in the C-7 basin, estimated at 254,000 people (2020 Census), will either directly or indirectly benefit from this project. The overall flood protection levels of service and water supply protection from saltwater intrusion are expected to improve. Flood modeling results from the C-7 Basin Flood Protection Level of Service Study, as detailed in this proposal, demonstrate basin-wide benefits.

Community-Wide Benefits

SFWMD and Miami-Dade County have been shifting to incorporate a wider range of co-benefits (social, environmental, operational) into their projects to consider equity community-wide. In the context of the proposed project, “community-wide” refers to the historical, cultural, and recreational values that South Florida residents share. This project is aligned with the SFWMD Sea Level Rise and Flood Resiliency Plan and Miami-Dade County’s goals of promoting resilience in a way that goes beyond environmental sustainability (<https://www.miamidade.gov/global/management/strategic-plan/home.page>) The County encourages jurisdictions to take a holistic approach for resilience efforts across four broad dimensions: Leadership and Strategy, Economy and Society, Health and Wellbeing, and Infrastructure and Environment. Their vision is “Delivering excellent service today and tomorrow.” The SFWMD, as the agency responsible for the primary control system, works closely with the County and local jurisdictions to instill these values, particularly with respect to preparing for disasters and extreme events.

Impacts to Lifelines

This project will reduce direct and indirect flood impacts on Community Lifelines, residents, businesses, public services, infrastructure, and natural systems through three key lifelines: Food, Water, Shelter, Transportation, and Energy. Food, Water, Shelter - The proposed project significantly reduces the threat to property. Under the lifeline subcategory of shelter, the project increases the level of protection for over 80,527 primary homes across the area. Without the project, it would take months for residents whose homes may be significantly damaged to stabilize their living situation. Given the level of damage expected, residents would be displaced while repairs to homes occurred. Many of the basin's single-family homes are on septic tank systems. The septic tank systems east of I95 are particularly vulnerable to sea level rise. In recent years, several properties in this basin have had to retrofit their septic system due to system failure. Alleviation of flooding would minimize future failures.

Transportation

The S-27 Structure is bordered by U.S. 1 to the east and SR934 to the south. These roads are key evacuation routes and connectors for the region. The project would alleviate flooding and allow these main arteries to function and be more easily accessible during extreme events.

Safety and Security

In addition, 118 critical assets would be protected under the proposed project. These include Airports (2), Fire Stations (9), Hazardous Waste Transport Facilities (7), Heliports (1), Hospitals/Medical Facilities (12), Law Enforcement Centers (11), and Public Schools (76). The proposed project removes a portion of utility infrastructure from the floodplain.

Impacts to Disadvantaged Communities

To ensure forty percent (40%) of the overall project benefits flow to disadvantaged communities that are marginalized, underserved, and overburdened by environmental stressors, the District used data available through the Climate and Economic Justice Screening Tool (CEJST) and the Centers for Disease Control and Prevention (CDC) Agency for Toxic Substances and Disease Registry (ATSDR) Social Vulnerability Index (SVI). Based on these data, ninety-four percent (94%) of the population within the project impact area were identified as socioeconomically disadvantaged and will receive equal access to community-wide benefits from the implementation of this resiliency project. These benefits are mainly related to flood risk reduction measures, environmental benefits, and the opportunities created for education, recreation, and development. The CEJST identifies forty-six percent (46%) of the population within the project impact as disadvantaged under the Climate Change category. The climate change category quantifies and considers the percent low-income population and higher education non-enrollment as well as expected population, building, and agricultural loss rates above pre-determined thresholds. The CDC identifies sixty-seven percent (67%) of the population within the project impact areas as having an SVI greater than 0.8 or higher, the highest vulnerability ranking, and twenty-seven percent (27%) of the population within the project impact area as having an SVI between 0.6 and 0.8, the second highest vulnerability ranking. The CDC/ATSDR SVI ranks each census tract on 16 social factors, including poverty, lack of vehicle access, and crowded housing, and groups them into four related themes.

Project Scope

The proposed project consists of flood mitigation and enhancement strategies at C-7 Basin, known as Litter River, in Miami-Dade County, to build flood resiliency and increase protection against saltwater intrusion. Specifically, the project includes:

- Enhancing major components of the S-27 Structure and converting the gate opening system to a more robust mechanism, upgrading the existing gates with elevated, corrosion-resistant stainless-steel gates, enhancing and elevating the control building, and adding a corrosion control system to the structure.
- Building a new forward pump station that will convey flood waters to tide when downstream water elevations are too high to allow gravity flow. The design of the proposed forward pump station will be adaptable and will include the ability to easily add additional pump capacity in the future as conditions continue to change.
- Constructing a tie-back levee/salinity barrier to provide flood and storm surge protection and supporting the required function of the spillway gates and pump for the selected scenario of a 100-year event with a three-foot sea level rise.

- Building an approximately 2-acre flow-through wetland/stormwater detention area to reduce local runoff on the W.H. Turner High School property (owned by Miami-Dade County Public Schools). This project feature will increase the ability to leverage partners and enhance outreach activities and emphasize community engagement. This stormwater detention area will be incorporating Biosorption Activated Media (BAM), an innovative stormwater best management practice in South Florida that has been deployed across agencies and in varied use cases and has consistently reduced harmful nutrients such as Nitrogen, Phosphorus, and other contaminants in stormwater. BAM is a patented unique combination of recycled tire crumb, silt, clay, and sand that is optimized for inert filtration and reactive filtration and to provide an ideal habitat for microbes to facilitate biosorption & biological uptake.
- Installing 1,500 linear feet of living shoreline along the C-7 Canal Bank to assist in reducing bank erosion and improve aesthetics and storm resiliency. The flow-through wetland/stormwater detention area and living shoreline features will be incorporated into the W.H. Turner High School curriculum for environmental science students. In addition, a shaded gathering area, a community garden, educational signage, and outdoor classroom amenities for public use and to increase community engagement will be incorporated into the project.

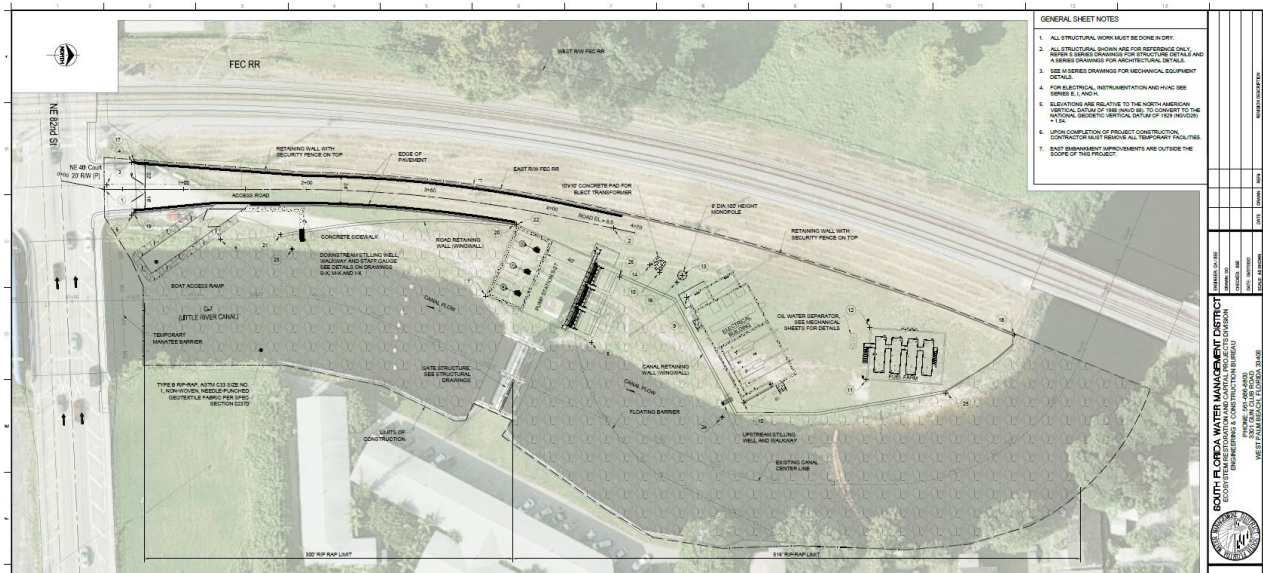

Figure 9-14: Site plan at S-27 Structure.

Reducing Risk and to What Level

Extensive land development and population increases within the basin have already exceeded the original design assumptions of the C-7 Canal and S-27 Structure. Significant changes in climate conditions and sea level rise have also impacted the area and are limiting flood protection operations. These risks and their potential impacts are multifaceted and involve flood hazards driven by storm surges, high tides, and extreme rainfall. This project will reduce flooding risk by reducing peak canal stages, bank exceedances, and overland flood inundation throughout the C-7 Basin for the 5-year, 10-yr, 25-yr, and 100-yr storm events and under different sea level rise scenarios, as demonstrated by hydrology and hydraulics model simulations. The project consists of local and regional flood mitigation strategies that reduce flood risk and enhance resiliency. These mitigation strategies will increase the resilience of the entire C-7 Basin. A range of critical assets, including fire stations, emergency shelters, and medical facilities, support several Community Lifelines and a variety of cultural, historical, and environmental resources in the basin. Additionally, the County has a high Building Code Effectiveness Grading Schedule (BCEGS) score of 2, which shows a commitment to reducing risk through strong building code adoption and enforcement activities.

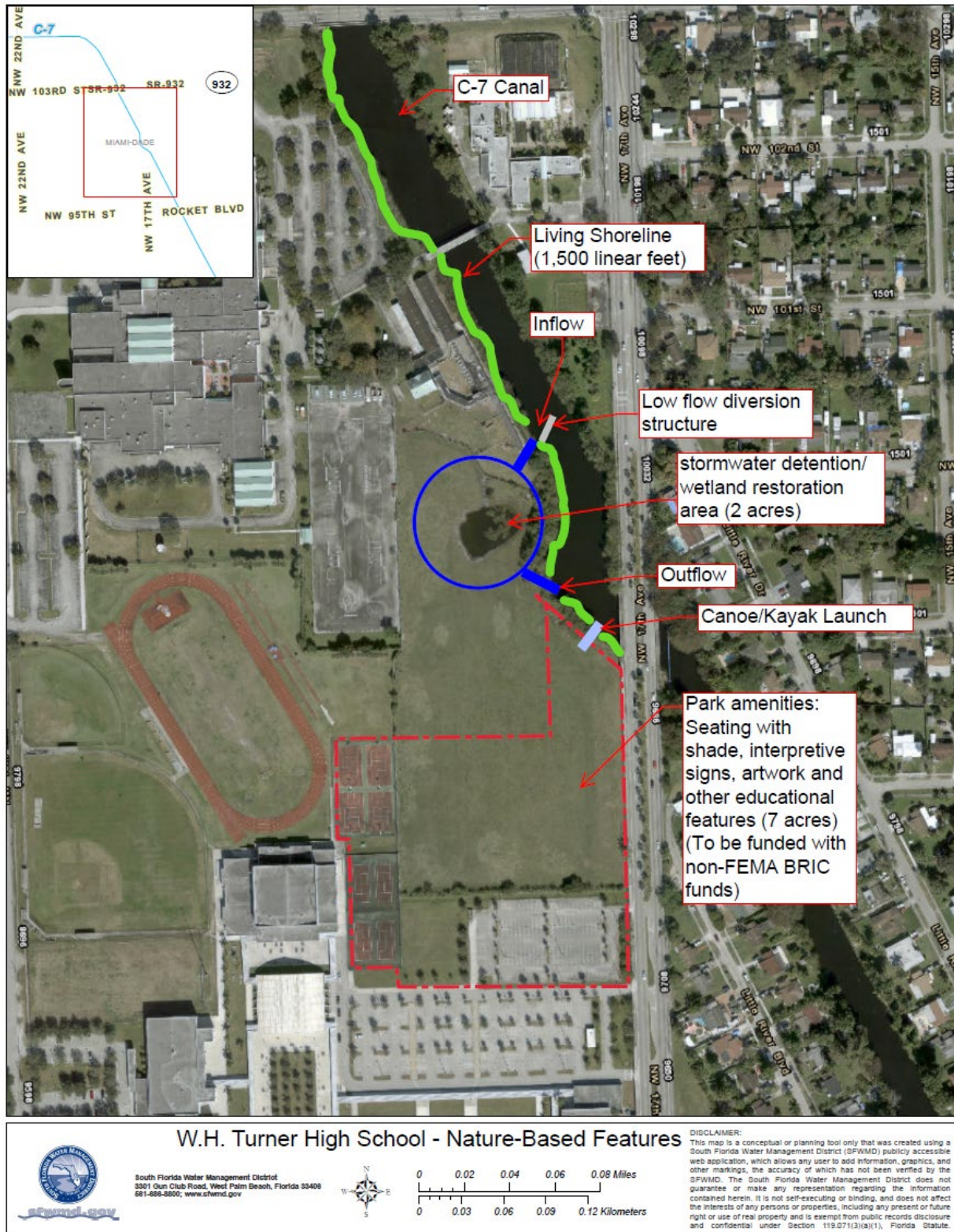

Figure 9-15: Nature-based features at W.H. Turner High School

Increase Resilience

The project components to increase resilience include enhancements to the S-27 Structure and the addition of a forward pump and a tie-back levee. The pump will maintain basin discharge capacity while sea levels rise. The new levee and increased elevation of the flood control gates and service bridge will help prevent overtopping and reduce saltwater intrusion risk. A significant aspect of this project includes the construction of demonstration project-level nature-based features at W.H. Turner Technical High School in partnership with Miami-Dade County Public Schools. The proposed components include building a flow-through wetland/stormwater detention area and installing a living shoreline to reduce bank erosion and indirectly enhance water quality and aquatic habitat. The overall strategy to reduce runoff in this densely urbanized basin includes the implementation of a series of distributed storage solutions. This project can serve as an example regionally, as nearby jurisdictions are looking to implement similar measures. The project will also be incorporated into the school curriculum for environmental science students, adding an important educational component.

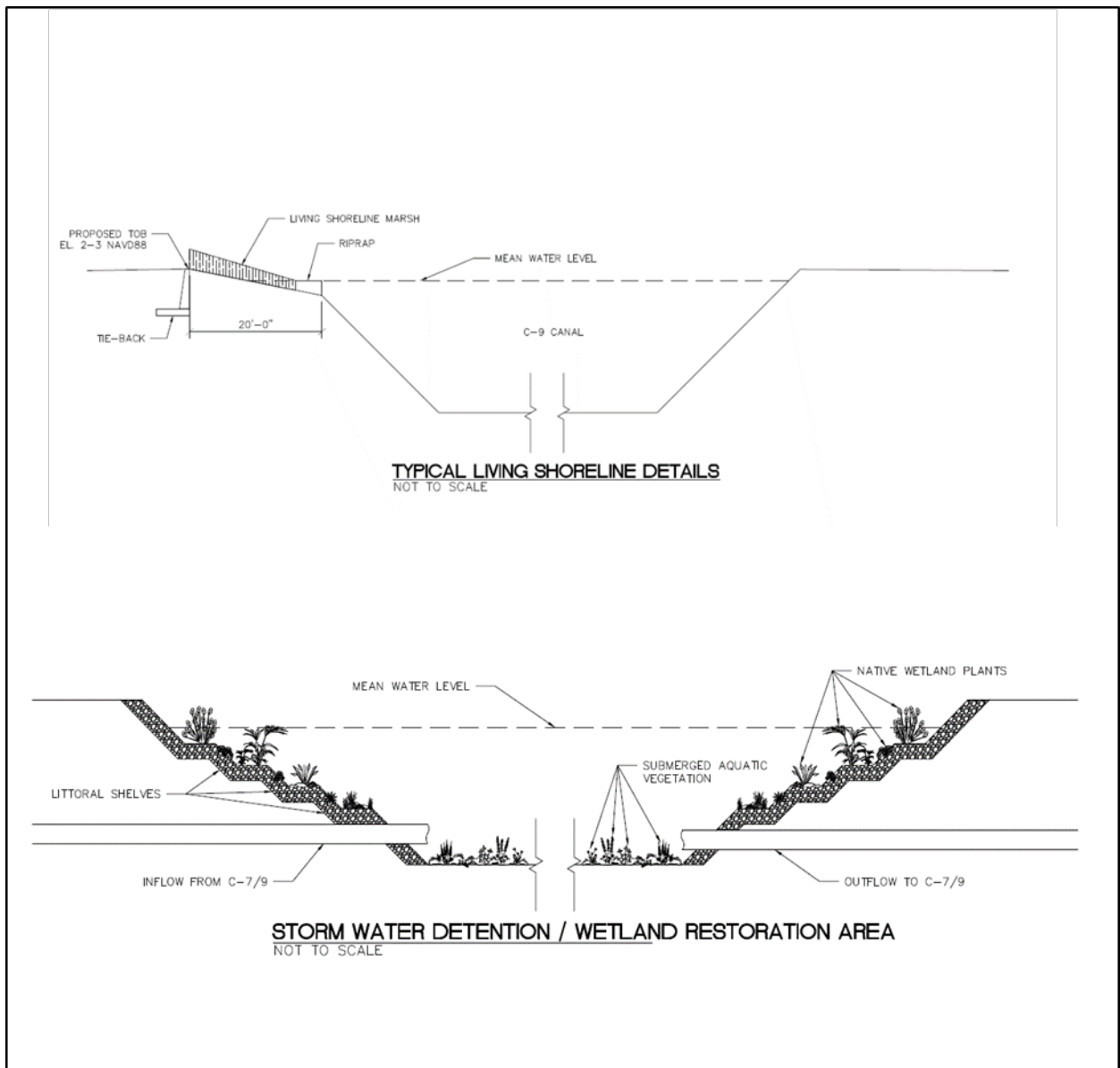

Figure 9-16: Typical living shoreline detail and stormwater detention area/wetland restoration area

Ancillary Benefits

Beyond enhancing the flood protection level of service, the project aims to maximize the risk reduction benefits and co-benefits of nature-based solutions and improve the C-7 Basin's water quality and ecological functions. Benefits include short and long-term environmental, economic, and social advantages that improve a community's quality of life, emphasize community engagement, and increase recreational value in the project area (kayaking, canoeing, wildlife observation, and fishing). Ancillary benefits also include improved fish and wildlife habitat from the implementation of the living shoreline features, improved land value due to reduced flood risk and enhanced aesthetics, prevention of canal bank

erosion, water quality benefits from the implementation of the flow-through wetland/stormwater detention area and increased opportunities for education and recreation (outdoor classroom activities).

Leveraging Innovation

This project will introduce green infrastructure features that have not been used previously in this area. While Miami-Dade County is eager to pilot linear parks, living shorelines, and expand Greenways and Blueways, this project will be one of the first opportunities in this basin. The County conducted stakeholder engagement to share the approaches and gather feedback. The community most enthusiastically supported the green infrastructure approaches.

Outreach Activities

A comprehensive public outreach process is embedded in the SFWMD Sea Level Rise and Flood Resiliency Plan – Annual Update and the Flood Protection Level of Service Program (FPLOS), along with the and the Miami-Dade Sea Level Rise Strategy, to ensure equal opportunity for all members of South Florida communities to participate in the planning and decision-making process. The public and key stakeholders contributed to informing the identification of priority adaptation strategies through several workshops and public comments.

S-27 Cost Estimate

Structure Hardening	\$5,642,523
Construction of 1400 cfs Forward Pump at S-27 Structure	\$67,200,000
Forward Pump Backup Generator	\$6,720,000
Structure Tieback Levee	\$2,000,000
Design & Construction Management	\$12,234,378
Real Estate	\$10,000,000
Total Cost for S-27	\$103,796,902
Adjusted 2023 Cost	\$125,370,188
Design and Permitting of Green Infrastructure	\$200,000
Construction of Green Infrastructure	\$1,300,000
Total Cost with Green Infrastructure	\$126,870,189

S-26 Coastal Structure Resiliency

This resiliency project is mainly tied to the District's mission to provide flood control and water supply protection. S-26 is a two-bay, reinforced concrete gated spillway located in the City of Miami at the NW 36th Street crossing of the Miami (C-6) Canal, between NW North River Drive and NW South River Drive, northeast of the Miami International Airport.



The structure consists of two 14.1 feet high by 26.0 feet wide gates with a discharge capacity of 3,470 cfs. The discharge from the structure is controlled by two hydraulically driven cable-operated vertical lift gate mechanisms. The gates can either be remotely operated from the District Control Room or controlled on-site. To maintain flood protection for the C-6 basin, a 600 cfs. pump station was added to the S-26 spillway as part of the Miami-Dade County Flood Mitigation Program. The S-26 is the outlet to tide for the C-6 basin. The structure maintains optimum water control stages upstream in the C-6 Canal. It was designed to pass 100% of the Standard Project Flood (SPF) without exceeding the upstream flood design stage and restricts downstream flood stages and discharge velocities to non-damaging levels, and prevents saltwater intrusion during periods of extreme, high tides. The structure is maintained by the Miami Field Station.

The purpose of this project is to build resiliency, restore the design discharge of the S-26 Structure and decrease flood impacts within the C-6 Basin due to sea level rise, climate change, and land use changes in the basin. The project's conceptual design is finalized. The final design will be based on a simulation of the combined regional and local hydraulic measures in the C-6 Basin. The S-26 structure will be enhanced by raising the bridge, converting the gate opening system to a more robust mechanism, replacing the existing gates with taller corrosion-resistant stainless-steel gates and replacing the control building with an elevated control building, and adding a corrosion control system to the structure. Flood barriers will be constructed around the coastal structure to tie it back to higher land. The design of a forward pump station will be adaptable and will include the ability to easily add additional pumps in the future as environmental conditions change. The current design includes a pumping capacity of 1735 cfs.

There is an urgent need to identify and purchase lands in this area to accommodate future structure modifications and pump station sizing.

In 2023, the District is replacing existing pumps at this location as part of the normal operations and maintenance program. The pump capacity will not be increased as part of this maintenance because the existing control building and structure cannot support increasing the pump size. One important consideration at this site is that the system needs to be fully operational during construction.

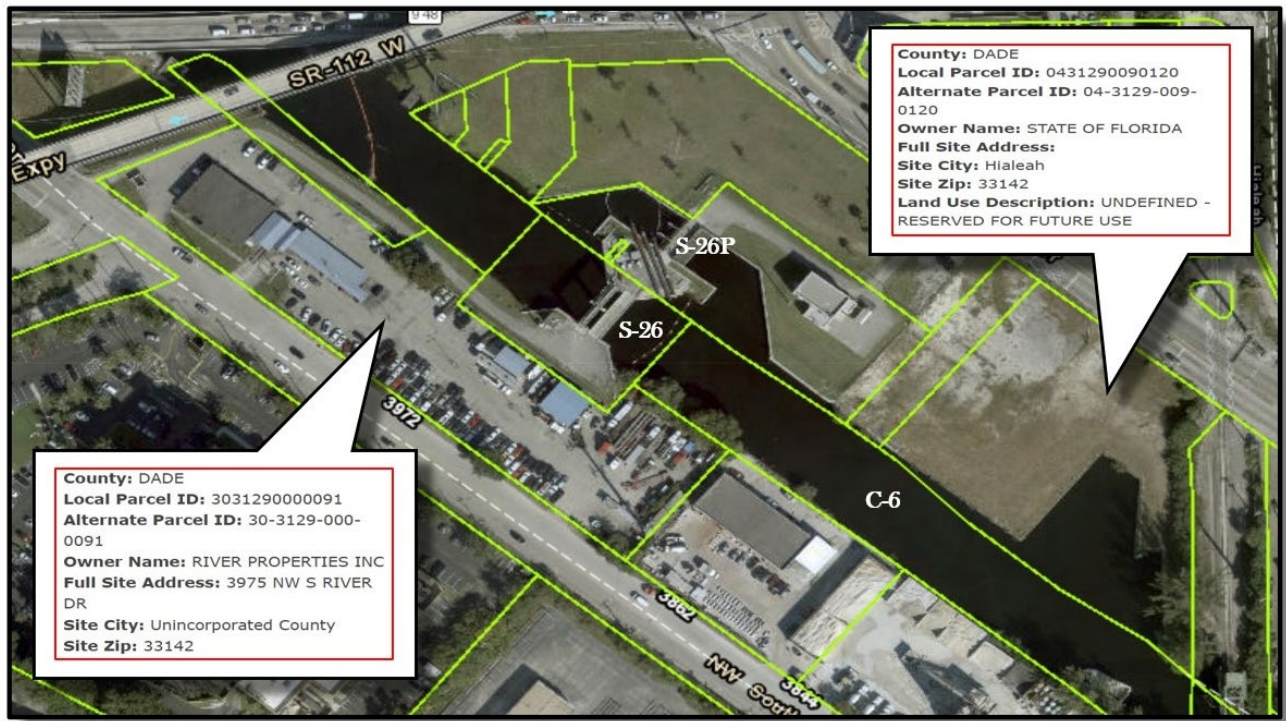

Figure 9-17: Land Needs for S-26 Structure Enhancements

The entire population currently living in the C-6 Basin, estimated at 223,766, will directly or indirectly benefit from this project. The total number of critical assets vulnerable to flooding under current and future conditions in the C-6 Basin is 226. These include airports, faith-based facilities, fire stations, waste management facilities, hospitals and medical facilities, law enforcement centers, and schools. Public schools have a vital role during emergency storm evacuations and post-storm recovery efforts, serving as shelters for displaced residents and emergency response staging areas. Overall flood protection levels of service are expected to increase in the entire basin with project implementation, as well as water supply protection from saltwater intrusion.

The project will provide 20-40 years of protection against sea level rise, depending on the scenario (Intermediate Low or NOAA Intermediate High). The peak canal stage can be reduced by 15% with each

500 cfs increase in forward pumping capacity. The pump station facility will have a useful life of approximately 50 years.

A total cost estimate to harden this Coastal Structure to address flooding, sea level rise, and other related risks to vulnerable communities in the Basin is presented below.

S-26 Cost Estimate

Structure Enhancement	\$ 7,101,519
Forward Pump (1735 cfs)	\$83,280,000
Forward Pump Backup Generator Facility	\$ 8,328,000
Structure Tie Back (Flood Barrier)	\$ 2,000,000
Design, Implementation & Construction Management	\$15,106,428
Real Estate	\$ 2,404,512
Total	\$118,220,458
2023 Adjusted Cost	\$ 144,858,126

G-57 Coastal Structure Resiliency



This resiliency project is mainly tied to the District's mission to provide flood control and water supply protection. G-57 is a reinforced concrete, gated spillway with discharge controlled by two stem-operated, vertical lift gates measuring 6 feet high by 14 feet wide. The discharge capacity at G-57 is 375 cfs. The operation of the gates is automatically controlled so that the gate operating system opens or closes the gates in accordance with the operational criteria. The structure is located on the Old Pompano Canal

just east of Cypress Road. This structure maintains upstream water control stages in Old Pompano Canal. The G-57 Structure was designed to 1) release the design flood without exceeding the upstream flood design stage, 2) restrict downstream flood stages and channel velocities to non-damaging levels, and 3) prevent saline intrusion. G-57 is serviced by the Fort Lauderdale Field Station. The SFWMD FPLOS developed advanced H&H models to evaluate system operations under changed current and future conditions and recommended infrastructure investments in critical locations. Recent observations and FPLOS model results show that the G-57 Structure needs adaptation. The FPLOS results and recent observations show the G-57 Coastal Structure is no longer providing the design level of service, which impacts the overall flood protection level of service in the C-14 Basin. The flood protection level of service in the C-14 Basin is currently equivalent to a five-year rainfall/flood event recurrence interval. The level of service is reduced to a less than five-year event under a two-foot sea level rise scenario.

The entire population currently living in the C-14 Basin, estimated at 302,629, will directly or indirectly benefit from this project. The number of critical assets vulnerable to flooding under current and future conditions at C-14 Basin is 57. These include faith-based facilities, fire stations, hospitals and medical facilities, law enforcement centers, recreational facilities, and schools. Public schools have a vital during emergency storm evacuations and post-storm recovery efforts, serving as shelters for displaced residents and emergency response staging areas. Overall flood protection levels of service are expected to increase in the entire basin, as well as water supply protection from saltwater intrusion contamination with project implementation.

Enhancing the G-57 structure will restore discharge capacity by adding a forward pump to convey flood waters when the downstream water elevations preclude gravity flow. These modifications will protect flood-prone areas within the C-14 Basin. The proposed project will provide 20-40 years of protection

against sea level rise, depending on the scenario (NOAA Intermediate Low or NOAA Intermediate High). The peak canal stage can be reduced by 15% for each 500 cfs increase in pump capacity.

The purpose of this project is to build resiliency, restore the design discharge of the G-57 Structure and decrease flood impacts within the C-14 Basin due to sea level rise, climate change, and land use changes in the basin. The project's conceptual design is finalized. The final design will be based on a simulation of the combined regional and local hydraulic measures in the C-14 Basin. The G-57 structure will be enhanced and hardened by raising the bridge, converting the gate opening system to a more robust mechanism, replacing the existing gates with corrosion-resistant stainless-steel gates and increased height, replacing the control building with a hardened and elevated control building, and adding a corrosion control system to the structure. Flood barriers will be constructed around the coastal structure to tie it back to higher land. The design of a forward pump station will be adaptable and will include the ability to easily add additional pumps in the future as environmental conditions change.

The design life for the facility is 50 years, with consideration for mechanical equipment being rehabilitated or replaced over the design life. The engines may require at least one major overhaul during the design life, while the pump materials will be designed to provide long service life. The structural and architectural design of the pump stations will include elements that will require minimum maintenance and repair over the design life.

A total cost estimate to harden this Coastal Structure to address flooding, sea level rise, and other related risks to vulnerable communities in the Basin is presented below. The estimate includes modifications to the existing structure and control building, as well as an additional forward pump. The supplementary pumping capacity will extend the conveyance performance for additional years as sea levels rise, delay out-of-bank flooding, and reduce canal peak stages. Placeholder funds to tie the structure to higher land elevations and to purchase real estate for the project are included. Negotiations with private property owners for land purchase will initiate upon funding confirmation.

G-57 Cost Estimate

Structure Enhancement	\$ 5,316,285
Forward Pump (200cfs)	\$10,312,500
Forward Pump Backup Generator Facility	\$ 1,031,250
Structure Tie Back (Flood Barrier)	\$ 2,000,000
Design, Implementation & Construction Management	\$ 2,799,005
Real Estate	\$ 7,000,000
Total	\$28,459,040
Adjusted 2023 Cost	\$ 33,394,620

S-22 Coastal Structure Resiliency

This resiliency project is mainly tied to the District’s mission to provide flood control and water supply protection. S-22 is a two-bay, reinforced concrete gated spillway located in C-2 (Snapper Creek) Canal, about 7,000 feet from the mouth of Biscayne Bay and about ten miles southwest of downtown Miami. The C-2 Canal has an open channel connection with the C-4 Canal, west of the intersection of Turnpike and Miami SW 8th Street. The structure has two (2) 15.0 feet high by 17.7 feet wide gates and a discharge capacity of 1905 cfs. The gates are operated by an electric-driven cable drum. The gates can either be remotely operated from the District Control Room or controlled on-site. The purpose of S-22 is to permit the release of flood runoff from the tributary basin, prevent over-drainage, and prevent saltwater intrusion during periods of extreme, high tides. The structure maintains optimum stages upstream in the C-2 Canal. The structure is maintained by the Miami Field Station.



The project consists of enhancing the S-22 Coastal Structure and installing forward pumps to increase its resiliency and maintain basin discharge levels while sea levels rise. The SFWMD has developed advanced H&H models to evaluate system operations under changed current and future conditions and recommended infrastructure investments in critical locations. Recent observations and model results show that the S-22 Structure needs adaptation.

The FPLOS Assessment for the C-2 Basin will be available in 2023. A similar study to assess the impacts of sea level rise at tidal structures was conducted. The Low-lying Tidal Structure Assessment Susceptibility to sea level rise and Storm Surge report models show the level of service of the S-22 structure is equivalent to a 100-year event recurrence interval under current (sea level) conditions. The structure does not meet the design level of service under a 0.5-foot sea level rise scenario beyond a ten-year event and would not meet the design level of service under a one-foot sea level rise scenario for all return periods (2yr, 5yr, 10yr, 25yr, 50yr, 100yr).

Enhancing the S-22 Structure will restore discharge capacity by adding a forward pump to convey flood waters when downstream water elevations preclude gravity flow. These modifications will protect flood-prone areas within the C-2 Basin (population 289,878). The project will provide 20-40 years of protection

against sea level rise depending on the scenario (NOAA Intermediate Low or NOAA Intermediate High). The peak canal stage can be reduced by 15% for each 500cfs increase in pump capacity.

The purpose of this project is to build resiliency, restore the design discharge of the S-22 Structure and decrease flood impacts within the C-2 Basin due to sea level rise, climate change, and land use changes in the basin. The project's conceptual design is finalized. The final design will be based on a simulation of the combined regional and local hydraulic measures in the C-2 Basin. The S-22 structure will be enhanced and hardened by raising the bridge, converting the gate opening system to a more robust mechanism, replacing the existing gates with corrosion-resistant stainless-steel gates and increased height, replacing the control building with a hardened and elevated control building, and adding a corrosion control system to the structure. Flood barriers will be constructed around the coastal structure to tie it back to higher land. The design of a forward pump station will be adaptable and will include the ability to easily add additional pumps in the future as environmental conditions change. The proposed design includes a pumping capacity of 1000 cfs.

The design life for the facility is 50 years, with consideration for mechanical equipment being rehabilitated or replaced over the design life. The engines may require at least one major overhaul during the design life, while the pump materials will be designed to provide long service life. The structural and architectural design of the pump stations will include elements that will require minimum maintenance and repair over the design life.

The entire population currently living in the C-2 Basin, estimated at 289,878, will directly or indirectly benefit from this project. The number of critical assets vulnerable to flooding under current and future conditions at C-2 Basin is 300. These include faith-based facilities, fire stations, hospitals and medical facilities, law enforcement centers, recreational facilities, and schools. Public schools have a vital role during emergency storm evacuations and post-storm recovery efforts, serving as shelters for displaced residents and emergency response staging areas. Overall flood protection levels of service are expected to increase in the entire basin, as well as water supply protection from saltwater intrusion contamination.

A total cost estimate to harden this Coastal Structure to address flooding, sea level rise, and other related risks to vulnerable communities in the Basin is presented below. The estimate includes modifications to the existing structure and control building, as well as an additional forward pump. The supplementary pumping capacity will extend the conveyance performance for additional years as sea levels rise, delay out-of-bank flooding, and reduce canal peak stages. Placeholder funds to tie the structure to higher land elevations and to purchase real estate for the project are included. Negotiations with private property owners for land purchase will initiate upon funding confirmation.

S-22 Cost Estimate

Structure Enhancement	\$ 5,997,785
Forward Pump (1000cfs)	\$47,625,000
Forward Pump Backup Generator Facility	\$ 4,762,500
Structure Tie Back (Flood Barrier)	\$ 2,000,000
Design, Implementation & Construction Management	\$ 9,057,792
Real Estate	\$ 7,000,000
Total	\$76,443,078*
Adjusted 2023 Cost	\$92,414,986

*May need to be replaced rather than refurbished; costs may be higher.

S-37A Coastal Structure Resiliency



This resiliency project is mainly tied to the District's mission to provide flood control and water supply protection. This structure is a reinforced concrete, gated spillway with discharge controlled by two stem-operated vertical lift gates. The structure has a discharge capacity of 3,890 cfs. The operation of the gates is automatically controlled so that the gate operating system opens or closes the gates in accordance with the operational criteria. The structure is located on C-14, 150 feet east of Dixie Highway and

just east of the F.E.C. Railroad. The S-37A Structure was designed to 1) maintain optimum upstream water control stages in C-14; 2) release the design flood (40% and 60% of the Standard Project Flood from the western and eastern portions of the drainage basin, respectively) without exceeding the upstream flood design stage, 3) restricts downstream flood stages and channel velocities to non-damaging levels; and 4) prevent saltwater intrusion during periods of extreme, high tides. S-37A is maintained by the Fort Lauderdale Field Station. A total cost estimate to harden this Coastal Structure to address flooding, sea level rise, and other related risks to vulnerable communities in the Basin is presented below. The estimate includes modifications to the existing structure and control building, as well as an additional forward pump. The supplementary pumping capacity will extend the conveyance performance for additional years as sea levels rise, delay out-of-bank flooding, and reduce canal peak stages. Placeholder funds to tie the structure to higher land elevations and to purchase real estate for the project are included. Negotiations with private property owners for land purchase will initiate upon funding confirmation.

S-37A Cost Estimate

Structure Enhancement	\$ 6,240,444
Forward Pump (2000 cfs)	\$81,761,744.58
Forward Pump Backup Generator Facility	\$ 10,453,117
Structure Tie Back (Flood Barrier)	\$ 2,000,000
Design, Implementation & Construction Management	\$ 15,068,300
Real Estate	\$7,000,000
Total	\$122,523,638
Adjusted 2023 Cost	\$ 149,094,074

G-58 Coastal Structure Resiliency



This resiliency project is mainly tied to the District’s mission to provide flood control and water supply protection. G-58 is a four-barrel corrugated metal pipe culvert located on Arch Creek immediately downstream from the Florida East Coast Railroad bridge. Features include one 60-inch culvert and three 72-inch culverts. The discharge capacity of this structure is 300 cfs. The G-58 Structure was designed to maintain optimum upstream water control stages in Arch Creek, 2) release the design flood (60% of the Standard Project Flood) without

exceeding the upstream flood design stage, 3) restrict downstream flood stages and discharge velocities to non-damaging levels, and 4) prevent saltwater intrusion during periods of extreme, high tides. G-58 is serviced by the Miami Field Station.

A total cost estimate to harden this Coastal Structure to address flooding, sea level rise, and other related risks to vulnerable communities in the Basin is presented below. The estimate includes modifications to the existing structure and control building, as well as an additional forward pump. The supplementary pumping capacity will extend the conveyance performance for additional years as sea levels rise, delay out-of-bank flooding, and reduce canal peak stages. Placeholder funds to tie the structure to higher land elevations and to purchase real estate for the project are included. Adjacent lands are owned by the State of Florida, which will result in reduced real estate costs.

G-58 Cost Estimate

Structure Enhancement	\$ 6,136,884
Forward Pump (75cfs)	\$ 4,125,000
Forward Pump Backup Generator Facility	\$ 412,500
Structure Tie Back (Flood Barrier)	\$ 2,000,000
Design, Implementation & Construction Management	\$ 1,901,157
Real Estate	\$ 3,000,000
Total	\$17,575,542
Adjusted 2023 cost	\$20,927,917

S-123 Coastal Structure Resiliency



This resiliency project is mainly tied to the District's mission to provide flood control and water supply protection. S-123 is a fixed crest, reinforced concrete, gated spillway, with discharge controlled by two cable-operated, vertical lift gates measuring 12.7 feet high by 25.0 feet wide. The discharge capacity at this structure is 2,300 cfs. The operation of the gates is automatically controlled so that the gate hydraulic operating system opens or closes the gates in accordance with the operational criteria. The

structure is located near the mouth of C-100 below the junction of C-100, C100A, and C-100B and about 600 feet from the shore of Biscayne Bay. The S-123 Structure was designed to 1) maintain optimum water control stages upstream in Canals C- 100, C-100A, and C-100B, 2) release the design flood (40 percent of the Standard Project Flood) without exceeding the upstream flood design stage, 3) restrict downstream flood stages and discharge velocities to non-damaging levels, and 4) prevent saltwater intrusion during periods of extreme, high tides. The structure is maintained by Miami Field Station.

A total cost estimate to harden this Coastal Structure to address flooding, sea level rise, and other related risks to vulnerable communities in the Basin is presented below. The estimate includes modifications to the existing structure and control building, as well as an additional forward pump. The supplementary pumping capacity will extend the conveyance performance for additional years as sea levels rise, delay out-of-bank flooding, and reduce canal peak stages. Placeholder funds to tie the structure to higher land elevations and to purchase real estate for the project are included. Adjacent lands are owned by the State of Florida, which will result in reduced real estate costs.

S-123 Cost Estimate

Structure Enhancement	\$ 6,533,070
Forward Pump (1150 cfs)	\$55,200,000
Forward Pump Backup Generator Facility	\$ 5,520,000
Structure Tie Back (Flood Barrier)	\$ 2,000,000
Design, Implementation & Construction Management	\$10,387,960
Real Estate	\$ 7,000,000
Total	\$86,641,030
Adjusted 2023 Costs	\$ 104,958,469

S-20F Coastal Structure Resiliency

Inspection Summary/Issue Identification			
FY20 Update to FY15019 – (Updated 1-31-20)			
S-20F Major Half-Life Refurbishment		Date: 1-31-2020	
Structure Type: Spillway	Field Station / Contact: Homestead / Sean Smith	Priority Score: 17.02	Priority Level: 2
Inspector Information			
Lead Inspector: Tim Kunard	Inspection Date: 1-6-20	Phone: 561-582-6305	
Previous Inspection Date: 2-12-15		Previous Inspector: Gary Dunmyer	
F/S Superintendent: Sean Smyth		F/S Bureau Chief: Jesus Carrasco	
Signature: <i>[Signature]</i>		Signature: <i>[Signature]</i>	
Structure Details			
Description: Spillway	# Gates: 3	# Pumps: 0	# Barrels: 0
			Lifting Mechanism: Hydraulic

Figure 1 – Aerial image of the S20F Structure site



This resiliency project is mainly tied to the District’s mission to provide flood control and water supply protection. S-20F is a three-bay, reinforced concrete gated spillway located on the L-31E Levee at its junction with C-103 (Mowry) Canal, about 2,000 feet from the shore of Biscayne Bay and 190 feet east of SW 320th Street, approximately 8.7 miles southeast of the City of Princeton in eastern Miami-Dade County. The structure consists of three 13.0 feet high by 25.0 feet wide gates and has a discharge capacity of 2,900 cfs. Discharge from the structure is controlled by three hydraulically driven cable-operated vertical lift gates. The gates can either be remotely operated from the District Control Room or controlled on-site. The S-20F Structure was designed to 1) maintain

optimum stages upstream along the C-103 Canal, 2) restrict downstream flood stages and discharge velocities to non-damaging levels, and 3) prevent saltwater intrusion during periods of extreme, high tides. The structure is maintained by the Homestead Field Station.

A total cost estimate to harden this Coastal Structure to address flooding, sea level rise, and other related risks to vulnerable communities in the Basin is presented below. The estimate includes modifications to the existing structure and control building, as well as an additional forward pump. The supplementary pumping capacity will extend the conveyance performance for additional years as sea levels rise, delay out-of-bank flooding, and reduce canal peak stages. Placeholder funds to tie the structure to higher land elevations and to purchase real estate for the project are included. Adjacent lands are owned by the United States of America and are part of Biscayne National Park, which will result in reduced real estate costs.

S-20F Cost Estimate

Structure Enhancement	\$ 7,312,238
Forward Pump (725 cfs)	\$36,975,000
Forward Pump Backup Generator Facility	\$ 3,697,500
Structure Tie Back (Flood Barrier)	\$ 2,000,000
Design, Implementation & Construction Management	\$ 7,497,710
Real Estate	\$ 7,000,000
Total	\$64,482,4450
Adjusted 2023 Cost	\$77,703,413

S-21 Coastal Structure Resiliency



This resiliency project is mainly tied to the District’s mission to provide flood control and water supply protection. S-21 is a reinforced concrete gated spillway with three cable-operated vertical lift gates located near the mouth of C1 at its junction with L31E and about 3,500 feet from the shore of Biscayne Bay. Each gate measures 10.7 feet high by 27.8 feet wide. The discharge capacity of S-21 is 2,560 cfs. The operation of the gates is automatically controlled so that the hydraulic

operating system opens or closes the gates in accordance with the operational criteria. The S21 Structure was designed to 1) maintain optimum water control stages upstream in C1, 2) restrict downstream flood stages and discharge velocities to non-damaging levels, and 3) prevent saltwater intrusion during periods of extreme, high tides. The gates can be remotely controlled by either the on-site controls or from the SFWMD Control Room. The operation of the gate is automatically controlled so that the gate opens or closes in accordance with the operational criteria.

A total cost estimate to harden this Coastal Structure to address flooding, sea level rise, and other related risks to vulnerable communities in the Basin is presented below. The estimate includes modifications to the existing structure and control building, as well as an additional forward pump. The supplementary pumping capacity will extend the conveyance performance for additional years as sea levels rise, delay out-of-bank flooding, and reduce canal peak stages. Placeholder funds to tie the structure to higher land elevations and to purchase real estate for the project are included. Adjacent lands are owned by Miami-Dade County and are part of a county park, which will result in reduced real estate costs.

S-21 Cost Estimate

Structure Enhancement	\$ 7,328,487
Forward Pump (640 cfs)	\$32,640,000
Forward Pump Backup Generator Facility	\$ 3,264,000
Structure Tie Back (Flood Barrier)	\$ 2,000,000
Design, Implementation & Construction Management	\$ 6,784,873
Real Estate	\$ 7,000,000
Total	\$59,017,360
Adjusted 2022 Cost	\$70,981,354

S-21A Coastal Structure Resiliency

This resiliency project is mainly tied to the District's mission to provide flood control and water supply protection. S-21A is a reinforced concrete, two-bay, gated spillway located near the mouth of the C-102 canal (Princeton) at its junction with the L-31E Levee, about a mile from the shore of Biscayne Bay and immediately east of SW 97th Avenue. The structure consists of two 11.8 feet high by 20.8 feet wide gates and has a discharge capacity of 1300 cfs. The discharge from the structure is controlled by two hydraulically driven cable-operated vertical lift gates. The gates can be remotely controlled by either the on-site controls or from the SFWMD Control Room. The operation of the gate is automatically controlled so that the gate opens or closes in accordance with the operational criteria. Upstream of S-21A, the C-102 canal has an open junction with the L-31E canal on its north bank. The southern junction is controlled by a gated project culvert. A new pump station (S-705) is scheduled to be constructed at this junction as part of the Biscayne Bay Coastal Wetlands Project. The structure is maintained by Homestead Field Station.



A total cost estimate to harden this Coastal Structure to address flooding, sea level rise, and other related risks to vulnerable communities in the Basin is presented below. The estimate includes modifications to the existing structure and control building, as well as an additional forward pump. The supplementary pumping capacity will extend the conveyance performance for additional years as sea levels rise, delay out-of-bank flooding, and reduce canal peak stages. Placeholder funds to tie the structure to higher land elevations and to purchase real estate for the project are included. Adjacent lands are owned by Miami-Dade County, which will result in reduced real estate costs.

S-21A Cost Estimate

Structure Enhancement	\$ 6,288,289
Forward Pump (650 cfs)	\$33,150,000
Forward Pump Backup Generator Facility	\$ 3,315,000
Structure Tie Back (Flood Barrier)	\$ 2,000,000
Design, Implementation & Construction Management	\$ 6,712,993
Real Estate	\$ 7,000,000
Total	\$58,466,282
Adjusted 2023 Cost	\$ 70,303,527

G-93 Coastal Structure Resiliency

This resiliency project is mainly tied to the District's mission to provide flood control and water supply protection. G-93 is a two-bay, reinforced concrete gated spillway with two single-stem vertical lift gates measuring 5.0 feet high by 10.0 feet wide on the C-3 (Coral Gables) Canal, west of Southwest 57th Ave (Red Road or SR959) in the City of Coral Gables. This structure has a discharge capacity of 640 cfs. The C-3 Canal has an open connection to the C-4



Canal just east of the Palmetto Expressway and continues about 4.1 miles downstream of G-93 through highly urbanized South Miami areas before discharging to Biscayne Bay at Sunrise Harbor. The original structure, G-97, was replaced in January 1990 by G-93. The structure maintains optimum upstream water control stages; it was designed to pass 40% of the Standard Project Flood (SPF) plus a small discharge from the C-4 basin without exceeding the upstream flood design stage and restricts downstream flood stages and discharge velocities to non-damaging levels; and it prevents saltwater intrusion during periods of high tides. The structure is maintained by Miami Field Station.

A total cost estimate to harden this Coastal Structure to address flooding, sea level rise, and other related risks to vulnerable communities in the Basin is presented below. The estimate includes modifications to the existing structure and control building, as well as an additional forward pump. The supplementary pumping capacity will extend the conveyance performance for additional years as sea levels rise, delay out-of-bank flooding, and reduce canal peak stages. Placeholder funds to tie the structure to higher land elevations and to purchase real estate for the project are included. Adjacent lands are owned by Miami-Dade County and are part of Coral Gables Wayside Park, which will result in reduced real estate costs.

G-93 Cost Estimate

Structure Enhancement	\$ 4,231,301
Forward Pump (320 cfs)	\$16,960,000
Forward Pump Backup Generator Facility	\$ 1,696,000
Structure Tie Back (Flood Barrier)	\$ 2,000,000
Design, Implementation & Construction Management	\$ 3,733,095
Real Estate	\$ 7,000,000
Total	\$35,620,397
Adjusted 2022 Cost	\$ 42,203,088

S-25B Coastal Structure Resiliency



This resiliency project is mainly tied to the District's mission to provide flood control and water supply protection. S-25B is a two-bay, reinforced concrete gated spillway located in the City of Miami immediately east of the Northwest 42nd Avenue (Le Jeune Road) crossing of the C-4 (Tamiami) Canal, east of Miami International Airport. The structure consists of two 11.9 feet high by 22.8 feet wide gates with a discharge capacity of 2000 cfs. The gates are controlled

by two hydraulically driven cable-operated vertical lift gate mechanisms. The gates can either be remotely operated from the District Control Room or controlled on-site. Structure S-25B controls flow from the C-4 canal to the Miami Canal downstream of S-26. The structure maintains optimum stages upstream in the C-4 Canal. It was designed to pass 100% of the Standard Project Flood (SPF) for the eastern portion of the C-4 basin without exceeding the upstream flood design stage and restricts downstream flood stages and discharge velocities to non-damaging levels; and it prevents saltwater intrusion from the Miami Canal during periods of extreme, high tides. This structure also includes a forward pump station. The S-25B Forward Pump station is a reinforced concrete, electric pump station, with discharge controlled by three 200 cfs pumps. These pumps were added to the gravity structure S-25B in 2002 to maintain discharges from the land side to the seaside of the structure when gravity capacity is limited or the gates need to be closed due to the threat of saltwater intrusion. The pumped water flows into the 120-foot box culvert that runs under and along the edge of a golf course south of the S-25B spillway and discharges downstream (east) of S-25B into the C-4 Canal. The culvert is 10 feet high by 8 feet wide and consists of segmental sections with bell and spigot-type connections. The pumps can either be remotely operated from the District Control Room or controlled on-site. This structure is operated in coordination with the adjacent S-25B spillway. The structure is maintained by Miami Field Station.

A total cost estimate to harden this Coastal Structure to address flooding, sea level rise, and other related risks to vulnerable communities in the Basin is presented below. The estimate includes modifications to the existing structure and control building, as well as an additional forward pump. The supplementary pumping capacity will extend the conveyance performance for additional years as sea levels rise, delay out-of-bank flooding, and reduce canal peak stages. Placeholder funds to tie the structure to higher land elevations and to purchase real estate for the project are included. Adjacent lands are owned by Miami-Dade County, which will result in reduced real estate costs.

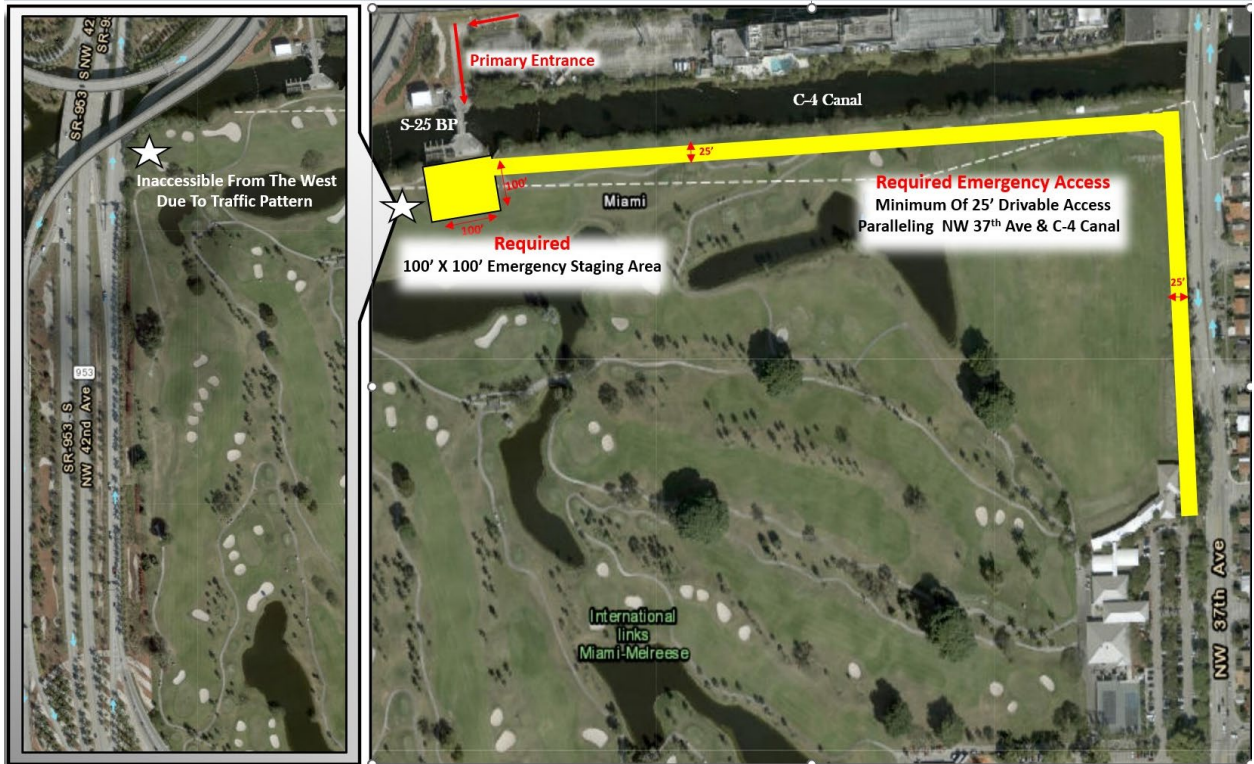

Figure 9-18: Real Estate Needs for S-25

S-25B Cost Estimate

Structure Enhancement	\$ 6,465,811
Forward Pump (1000 cfs)	\$48,000,000
Forward Pump Backup Generator Facility	\$ 4,800,000
Structure Tie Back (Flood Barrier)	\$ 2,000,000
Design, Implementation & Construction Management	\$ 9,189,872
Real Estate	\$ 7,000,000
Total	\$77,455,683
Adjusted 2023 Cost	\$ 93,660,490

G56 Coastal Structure Resiliency

This resiliency project is mainly tied to the District's mission to provide flood control and water supply protection. G-56 is a reinforced concrete gated spillway, with discharge controlled by three cable-operated vertical lift gates. This structure has a discharge capacity of 3,760 cfs. The gates are operated on-site or remotely from the District Control Room. The new structure was completed in 1991 to replace the old Deerfield Lock Structure. The structure is located near the mouth of the Hillsboro Canal, about two miles west of Deerfield Beach. This structure maintains optimum water control stages in the Hillsboro Canal. It passes flood flows while limiting the upstream stage, downstream stage, and channel velocity. G56 is serviced by the Fort Lauderdale Field Station.



A total cost estimate to harden this Coastal Structure to address flooding, sea level rise, and other related risks to vulnerable communities in the Basin is presented below. The estimate includes modifications to the existing structure and control building, as well as an additional forward pump. The supplementary pumping capacity will extend the conveyance performance for additional years as sea levels rise, delay out-of-bank flooding, and reduce canal peak stages. Placeholder funds to tie the structure to higher land elevations and to purchase real estate for the project are included. Negotiations with private property owners for land purchase will initiate upon funding confirmation.

G-56 Cost Estimate

Structure Enhancement	\$ 8,859,343
Forward Pump (1880 cfs)	\$90,240,000
Forward Pump Backup Generator Facility	\$ 9,024,000
Structure Tie Back (Flood Barrier)	\$ 2,000,000
Design, Implementation & Construction Management	\$16,518,501
Real Estate	\$ 7,000,000
Total	\$133,641,844
Adjusted 2023 Cost	\$162,769,468

G-54 Coastal Structure Resiliency



This resiliency project is mainly tied to the District’s mission to provide flood control and water supply protection. G-54 is a reinforced concrete gated spillway located on the North New River Canal about 0.9 miles west of the intersection of I-595 and Florida’s Turnpike, west of Fort Lauderdale. The structure consists of three 9.5 feet high by 16 feet wide gates with a discharge capacity of 1,600 cfs. The discharge from this structure is controlled by hydraulically driven cable-operated vertical lift gates. The gates can either be remotely operated from the District Control Room or

controlled on-site. Construction of G-54 was completed in 1992 to replace the old Sewell Lock Structure. This structure maintains optimum water control stages in the North New River canal. It passes watershed flows or regulatory releases from Water Conservation Area (WCA)-2 while limiting the upstream stage and channel velocity. G-54 is serviced by the Fort Lauderdale Field Station.

A total cost estimate to harden this Coastal Structure to address flooding, sea level rise, and other related risks to vulnerable communities in the Basin is presented below. The estimate includes modifications to the existing structure and control building, as well as an additional forward pump. The supplementary pumping capacity will extend the conveyance performance for additional years as sea levels rise, delay out-of-bank flooding, and reduce canal peak stages. Placeholder funds to tie the structure to higher land elevations and to purchase real estate for the project are included. Negotiations with private property owners for land purchase will be initiated upon funding confirmation.

G-54 Cost Estimate

Structure Enhancement	\$ 8,023,036
Forward Pump (800 cfs)	\$40,000,000
Forward Pump Backup Generator Facility	\$ 4,000,000
Structure Tie Back (Flood Barrier)	\$ 2,000,000
Design, Implementation & Construction Management	\$ 8,103,455
Real Estate	\$7,000,000
Total	\$ 69,126,492
Adjusted 2023 Cost	\$ 83,451,585

S-25 Coastal Structure Resiliency

This resiliency project is mainly tied to the District’s mission to provide flood control and water supply protection. S-25 is a single barrel, corrugated metal pipe culvert with a reinforced-concrete headwall and operating platform on the upstream (west) side. The structure is in the C-5 (Comfort) Canal, at the exit ramp from the East-West Dolphin Expressway (SR 836) and the crossing of Northwest 27th Avenue in the City of Miami. The structure consists of one 9.1 feet high by 8.3 feet wide gate with a discharge capacity of 320 cfs. S-25 can either be remotely operated from the District Control Room or controlled on-site. S-25 maintains an optimum upstream stage in C-5 Canal; it was designed to pass 1-in-10 flood without exceeding the upstream flood design stage and restricts downstream flood stages and discharge velocities to non-damaging levels; and it prevents saltwater intrusion during periods of extreme, high tides. The structure is maintained by Miami Field Station.



A total cost estimate to harden this Coastal Structure to address flooding, sea level rise, and other related risks to vulnerable communities in the Basin is presented below. The estimate includes modifications to the existing structure and control building, as well as an additional forward pump. The supplementary pumping capacity will extend the conveyance performance for additional years as sea levels rise, delay out-of-bank flooding, and reduce canal peak stages. Placeholder funds to tie the structure to higher land elevations and to purchase real estate for the project are included. Negotiations with private property owners for land purchase will be initiated upon funding confirmation. A portion of the needed property is owned by the Florida Department of Transportation, which may reduce land acquisition costs.

S-25 Cost Estimate

Structure Enhancement	\$ 3,695,352
Forward Pump (160 cfs)	\$ 8,800,000
Forward Pump Backup Generator Facility	\$ 880,000
Structure Tie Back (Flood Barrier)	\$ 2,000,000
Design, Implementation & Construction Management	\$ 2,306,303
Real Estate	\$ 7,000,000
Total	\$24,681,654
Adjusted 2023 Cost	\$ 28,748,435

S-33 Coastal Structure Resiliency



This resiliency project is mainly tied to the District's mission to provide flood control and water supply protection. S-33 is a reinforced concrete, gated spillway with discharge controlled by a cable-operated, vertical lift gate that is 9.0 feet high by 20.0 feet wide. The structure has a discharge capacity of 920 cfs. The gates can be remotely controlled by either the on-site controls or from the SFWMD Control Room. The operation of the gate is automatically controlled so that the gate opens or closes in accordance with the

operational criteria. The structure is located on C-12 about 1/2 mile east of State Road 7. This structure maintains optimum upstream water control stages in C-12; it passes the design flood (50% of the Standard Project Flood) without exceeding the upstream flood design stage and restricts downstream flood stages and channel velocities to non-damaging levels, and it prevents saltwater intrusion into the area west of the structure. S-33 is maintained by the Fort Lauderdale Field Station.

A total cost estimate to harden this Coastal Structure to address flooding, sea level rise, and other related risks to vulnerable communities in the Basin is presented below. The estimate includes modifications to the existing structure and control building, as well as an additional forward pump. The supplementary pumping capacity will extend the conveyance performance for additional years as sea levels rise, delay out-of-bank flooding, and reduce canal peak stages. Placeholder funds to tie the structure to higher land elevations and to purchase real estate for the project are included. Negotiations with private property owners for land purchase will initiate upon funding confirmation.

S-33 Cost Estimate

Structure Enhancement	\$ 4,237,616
Forward Pump (230 cfs)	\$12,650,000
Forward Pump Backup Generator Facility	\$ 1,265,000
Structure Tie Back (Flood Barrier)	\$ 2,000,000
Design, Implementation & Construction Management	\$ 3,022,892
Real Estate	\$ 7,000,000
Total	\$30,175,509
Adjusted 2023 Cost	\$ 35,505,876

S-20G Coastal Structure Resiliency

This resiliency project is mainly tied to the District’s mission to provide flood control and water supply protection. S-20G is a reinforced concrete gated spillway located near the mouth of the Military Canal at its junction with the L-31E Levee, about 2,300 feet from the shore of Biscayne Bay. The structure is located immediately north of SW 301 Street, approximately 8 miles east of the City of Homestead in eastern Miami-Dade County. The structure consists of a 12.3 feet high by 25.8 feet wide gate. The discharge capacity of S-20G is 900 cfs. The structure is controlled by a hydraulically driven cable-operated vertical lift gate. The gate can either be remotely operated from the District Control Room or controlled on-site. The operation of the gate is automatically controlled so that the hydraulic operating system opens or closes the gate in accordance with the operational criteria. Upstream of S-20G, the Military Canal does not have open junctions with the L-31E levee, and both junctions are controlled by gated (flashboard riser) project culverts (L-31E PC-17&18). The northern junction is controlled by Project Culvert L-31E PC-17, which controls flow between the C-102 (S-21A) basin and the Military Canal (S-20G) basin. The southern junction is controlled by Project Culvert L-31E PC-18, which controls flow between the C-103 (S-20F) basin and the Military Canal (S-20G) basin. The structure maintains optimum stages upstream in the Military Canal and restricts downstream flood stages and discharge velocities to non-damaging levels, and it prevents saltwater intrusion during periods of extreme, high tides. S-20G is maintained by Homestead Field Station.



A total cost estimate to harden this Structure to address flooding, sea level rise, and other related risks to vulnerable communities in the Basin is presented below. The estimate includes modifications to the existing structure and control building, as well as an additional forward pump. The supplementary pumping capacity will extend the conveyance performance for additional years as sea levels rise, delay out-of-bank flooding, and reduce peak stages. The District owns adjacent lands, which will eliminate real estate acquisition costs.

S-20G Cost Estimate

Structure Enhancement	\$ 4,084,410
Forward Pump (225 cfs)	\$12,375,000
Forward Pump Backup Generator Facility	\$ 1,237,500
Structure Tie Back (Flood Barrier)	\$ 2,000,000
Design, Implementation & Construction Management	\$ 2,954,536
Real Estate	\$ 7,000,000
Total	\$29,651,446*
Adjusted 2023 Cost	\$34,861,279

*May need to be replaced rather than refurbished; costs may be higher.

S-13 Coastal Structure Resiliency



This resiliency project is mainly tied to the District’s mission to provide flood control and water supply protection. S-13 is a pump station with a gated spillway that can control flow that bypasses the pumps. The structure is in C-11 (South New River Canal), about 300 feet west of U.S. Highway 441 and 5.5 miles southwest of Fort Lauderdale. It is a reinforced concrete structure with a concrete block superstructure. The pump station has a capacity of 540cfs at a 4-foot static head and is powered by a

diesel engine. The gated spillway features a 16-foot wide by 11-foot-high vertical liftgate, which is raised or lowered by means of stem hoists. Operation of the gate is normally controlled automatically but may be controlled manually during emergencies or for servicing. Other equipment includes a 5-ton manually operated overhead bridge crane for general maintenance. The purpose of the structure is to release flood runoff from, prevent over-drainage of, and saltwater intrusion into the agricultural area served by C-11 (South New River Canal) west of the structure. The spillway and pump station were designed to move surplus water from agricultural areas in the western portion of the basin at a rate of 3/4 inch per day while keeping water levels in the canal west of the structure at optimum water control stages. The agricultural areas have almost completely converted to residential and commercial use. This structure is maintained by the Fort Lauderdale Field Station.

A total cost estimate to harden this Coastal Structure to address flooding, sea level rise, and other related risks to vulnerable communities in the Basin is presented below. The estimate includes modifications to the existing structure and control building. The current site contains 3.5 acres. There is no additional room to expand, which will eliminate land acquisition costs.

S-13 Cost Estimate

Structure Enhancement	\$32,269,673
Forward Pump	\$ -
Forward Pump Backup Generator Facility	\$ -
Structure Tie Back (Flood Barrier)	\$ 2,000,000
Design, Implementation & Construction Management	\$ 5,140,451
Real Estate	\$ -
Total	\$39,410,124
Adjusted 2023 Cost	\$48,474,453

S-36 Coastal Structure Resiliency

This resiliency project is mainly tied to the District’s mission to provide flood control and water supply protection. S-36 is a reinforced concrete, gated spillway with discharge controlled by a cable-operated, vertical lift gate that is 14.0 feet high by 25.0 feet wide. The structure has a discharge capacity of 1,090 cfs. Operation of the gate is automatically controlled so that the gate electric motor opens or closes the gate in accordance with the seasonal operational criteria. The structure is located on C-13, west of Oakland Park. The S-36 Structure was designed to 1) maintain optimum water control stages upstream in C-13, 2) release the design flood (50 percent of the Standard Project Flood) without exceeding the upstream flood design stage, 3) restrict downstream flood stages and discharge velocities to non-damaging levels, and 4) prevent saltwater intrusion during periods of extreme, high tides. S-36 is maintained by the Fort Lauderdale Field Station.



A total cost estimate to harden this Coastal Structure to address flooding, sea level rise, and other related risks to vulnerable communities in the Basin is presented below. The estimate includes modifications to the existing structure and control building, as well as an additional forward pump. The supplementary pumping capacity will extend the conveyance performance for additional years as sea levels rise, delay out-of-bank flooding, and reduce canal peak stages. Placeholder funds to tie the structure to higher land elevations and to purchase real estate for the project are included. It can only expand south into property owned by the City of Oakland Park, which will reduce acquisition costs.

S-36 Cost Estimate

Structure Enhancement	\$ 4,619,722
Forward Pump (275 cfs)	\$14,442,500
Forward Pump Backup Generator Facility	\$ 1,444,250
Structure Tie Back (Flood Barrier)	\$ 2,000,000
Design, Implementation & Construction Management	\$ 3,375,971
Real Estate	\$ 7,000,000
Total	\$32,882,443
Adjusted 2023 Cost	\$ 38,835,405

S-197 Coastal Structure Resiliency

This resiliency project is mainly tied to the District's mission to provide flood control and water supply protection. S-197 is a four-barrel cast-in-place concrete box culvert with four vertical slide gates measuring 10.0 feet x 10.0 feet. The structure has a discharge capacity of 2,400 cfs. S-197 is located upstream of the mouth of the C-111, about three miles from the shore of Manatee Bay and 750 feet east of U.S. Highway 1. The gates are manually operated by the field station. Real-time stage data are available through telemetry. The S-



197 maintains optimum water control stages upstream in the C-111 Canal, prevents saltwater intrusion during high tides, and blocks reverse flow during storm surges. This structure usually remains closed to divert discharges from S-18C overland to the panhandle of the Everglades National Park. S-197 is opened for flood control when the overland flow capacity, with S-197 closed, is insufficient. This structure is maintained by the Miami Field Station.

A total cost estimate to harden this Coastal Structure to address flooding, sea level rise, and other related risks to vulnerable communities in the Basin is presented below. The estimate includes modifications to the existing structure and control building, as well as an additional forward pump. The supplementary pumping capacity will extend the conveyance performance for additional years as sea levels rise, delay out-of-bank flooding, and reduce canal peak stages. Placeholder funds to tie the structure to higher land elevations and to purchase real estate for the project are included. Adjacent lands are owned by the District and Miami-Dade County, which will reduce land acquisition costs.

The Biscayne Bay and Southeastern Everglades Ecosystem Restoration (BBSEER) Project is formulating plans to restore parts of the South Florida ecosystem in freshwater wetlands of the Southern Glades and Model Lands, the coastal wetlands and subtidal areas, including mangrove and seagrass areas, of Biscayne Bay, Biscayne National Park, Manatee Bay, Card Sound, and Barnes Sound. As part of project formulation, management measures being proposed as part of modeling alternatives under discussion include the removal of the S-197 Coastal and backfilling of the lower C-111 canal from S18-C to S-197. As final alternatives are formulated, the flood protection level of service in the project influence area will be maintained.

S-197 Cost Estimate

Structure Enhancement	\$ 6,358,510
Forward Pump (600 cfs)	\$30,600,000
Forward Pump Backup Generator Facility	\$ 3,060,000
Structure Tie Back (Flood Barrier)	\$ 2,000,000
Design, Implementation & Construction Management	\$ 6,302,776
Real Estate	\$ 7,000,000
Total	\$55,321,286
Adjusted 2023 Cost	\$ 66,435,182

S-20 Coastal Structure Resiliency



This resiliency project is mainly tied to the District’s mission to provide flood control and water supply protection. S-20 is a reinforced concrete, gated spillway located on L-31E about three miles from the shore of Biscayne Bay. The structure has a discharge capacity of 450 cfs, with discharge controlled by a cable-operated, vertical lift gate that is 11.4 feet high by 16.8 feet long. Operation of the gate is automatically controlled so that the gate’s hydraulic

operating system opens or closes the gate in accordance with the seasonal operational criteria. The S-20 Structure was designed to 1) maintain optimum water stages in the upstream agricultural area, 2) release the design flood (40 percent of the Standard Project Flood) without exceeding the upstream flood design stage, 3) restrict downstream flood stages and discharge velocities to non-damaging levels, and 4) prevents saltwater intrusion during periods of extreme high tides. The structure is maintained by the Homestead Field Station.

A total cost estimate to harden this Coastal Structure to address flooding, sea level rise, and other related risks to vulnerable communities in the Basin is presented below. The estimate includes modifications to the existing structure and control building, as well as an additional forward pump. The supplementary pumping capacity will extend the conveyance performance for additional years as sea levels rise, delay out-of-bank flooding, and reduce canal peak stages. Placeholder funds to tie the structure to higher land elevations and to purchase real estate for the project are included. Adjacent lands are owned by the District and Florida Power & Light, which may reduce land acquisition costs.

S-20 Cost Estimate

Structure Enhancement	\$4,198,152
Forward Pump	\$6,187,500
Forward Pump Backup Generator Facility	\$618,750
Structure Tie Back (Flood Barrier)	\$2,000,000
Design, Implementation & Construction Management	\$1,950,660
Real Estate	\$7,000,000
Total	\$21,955,062*
Adjusted 2023 Cost	\$ 25,394,727

*May need to be replaced rather than refurbished; costs may be higher.

Remaining Water Control Structures Resiliency

These resiliency projects link to the District’s mission to provide flood control and water supply protection. Additional water control structures are vulnerable to SRL and other changing conditions. As estimated projections are realized in the future, there will be the need to enhance the remaining structures not detailed in this Plan to increase their resiliency and maintain operational performance. Figure 9-19 below illustrates four sea level rise scenarios and inundation levels expected to occur by the end of this century and the location of critical water control structures that integrate the C&SF System and Big Cypress Basin in relation to these scenarios.

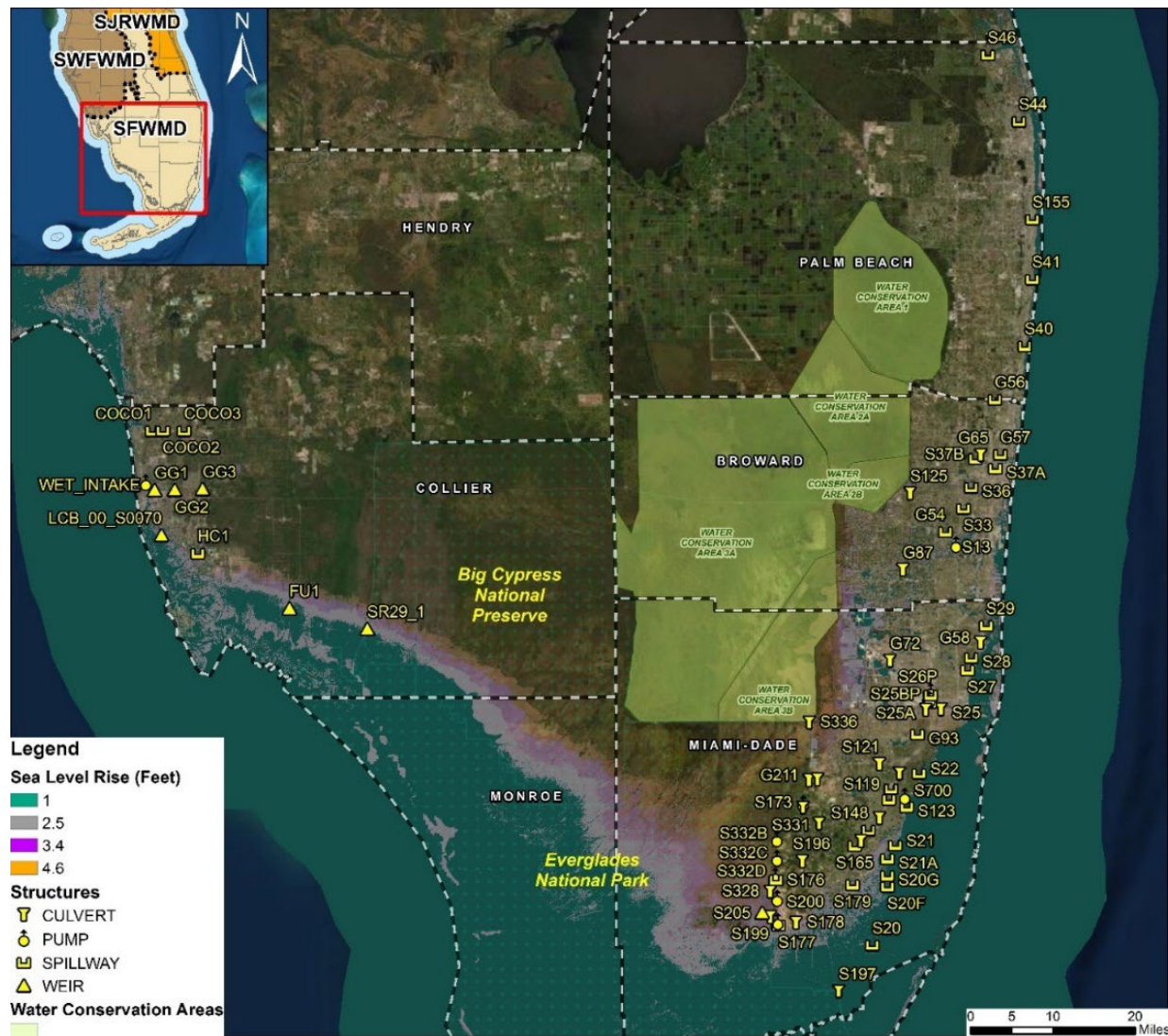

Figure 9-19: Potential Impacts of Rising Sea Levels on Water Control Structures

Initial placeholder costs are being proposed for structures identified to be within the inundation scenarios illustrated in Figure 9-19 above. These structures have not yet been assessed through H&H Models and will be refined during future modeling efforts and pre-design stages. The proposed costs are estimated to

enhance Coastal Structures identified in Table 9-6, to address flooding and other related risks to vulnerable communities at the respective basin level due to land development and changed climate conditions, including sea-level rise. The enhanced structure's capacity will extend its performance for additional years as seas rise, delay out-of-bank flooding, and reduce canal peak stages. These investments will need to be combined with additional upstream and downstream solutions to be characterized as part of FPLOS Phase II Adaptation Strategies and detailed as part of future design phases. Additional project costs detailed below were estimated for project recommendations from FPLOS Phase I Studies, as summarized in Appendix A.

Table 9-6: Remaining Coastal Structures and Placeholder Costs

Coastal Structures	Basin Name	Area (Acres)	Structure Enhancement Overall Estimated Costs (Placeholder)
G211	8.5 SQ. MILE AREA	4764.33	\$ 34,376,000.00
S119	C-100 WEST	16660.17	\$ 34,376,000.00
S148	C-1 WEST	32624.60	\$ 34,376,000.00
S155	C-51 EAST	47012.34	\$ 34,376,000.00
S165	C-102 WEST	8405.92	\$ 34,376,000.00
S178	C-111 AG	17563.47	\$ 34,376,000.00
S179	BD-C103 CENTRAL/WEST	22685.71	\$ 34,376,000.00
S200	FROGPOND DETENTION AREA	1727.37	\$ 34,376,000.00
S331	L-31NS	16838.66	\$ 34,376,000.00
S332B	NDA	2788.98	\$ 34,376,000.00
S332C	SDA	2473.26	\$ 34,376,000.00
S332D	S332D DETENTION AREA	3155.06	\$ 34,376,000.00
S37B	C-14 WEST	32246.98	\$ 34,376,000.00
S40	C-15	39423.02	\$ 34,376,000.00
S41	C-16	39812.66	\$ 34,376,000.00
S44	C-17	22357.07	\$ 34,376,000.00
S46	C-18 / CORBETT	65735.53	\$ 34,376,000.00
			\$ 34,376,000.00
COCO1	COCOHATCHEE	17628.52919	\$ 34,376,000.00
COCO2	COCOHATCHEE	17628.52919	\$ 34,376,000.00
COCO3	COCOHATCHEE	17628.52919	\$ 34,376,000.00
FU1	BIG CYPRESS BASIN	135740.3529	\$ 34,376,000.00
G65	C-14 EAST / C-14 WEST, POMPANO CANAL	36493.85798	\$ 34,376,000.00
G72	C-7 / C-6	54651.027	\$ 34,376,000.00
G737	FROGPOND	1727.365874	\$ 34,376,000.00
G87	C-11 EAST / WEST, C-9 EAST / WEST	122772.61089	\$ 34,376,000.00
GG1	GOLDEN GATE MAIN	71253.58016	\$ 34,376,000.00
GG2	GOLDEN GATE MAIN	71253.58016	\$ 34,376,000.00
GG3	GOLDEN GATE MAIN	71253.58016	\$ 34,376,000.00
HC1	HENDERSON – BELLE MEADE	47538.70388	\$ 34,376,000.00
LCB_00_S0070	EAST NAPLES	7390.151115	\$ 34,376,000.00
S118	C-100 WEST	16660.16722	\$ 34,376,000.00

Coastal Structures	Basin Name	Area (Acres)	Structure Enhancement Overall Estimated Costs (Placeholder)
S120	C-100 WEST	16660.16722	\$ 34,376,000.00
S700	C-100 EAST/C-100 WEST	25085.83454	\$ 34,376,000.00
S125	C-13 WEST, NORTH NEW RIVER CANAL WEST	33206.587	\$ 34,376,000.00
S149	C-1 WEST	32624.5955	\$ 34,376,000.00
			\$ 34,376,000.00
S195	C-102 WEST	8405.921685	\$ 34,376,000.00
S173	L-31NS, L-31 NCC	16923.28842	\$ 34,376,000.00
S176	L-31NS	16838.65942	\$ 34,376,000.00
S177	C-111 AG	17563.46884	\$ 34,376,000.00
S199	C-111 AG	17563.46884	\$ 34,376,000.00
S194	C-31NS, C-102 EAST / C-102 WEST	31884.239	\$ 34,376,000.00
S196	L-31NS, BD-C103 CENTRAL / WEST, BD-C103 EAST, NO-CANAL	46488.84507	\$ 34,376,000.00
S121	C-2	33654.88486	\$ 34,376,000.00
S205	S332D DETENTION AREA	3155.062	\$ 34,376,000.00
S328	S332D DETENTION AREA	3155.061629	\$ 34,376,000.00
S205	S332D DETENTION AREA	3155.061629	\$ 34,376,000.00
S33	C-12W	4780.585242	\$ 34,376,000.00
S173	L-31NCC	84.628584	\$ 34,376,000.00
S336	L-29 CC	225.026396	\$ 34,376,000.00
S338	L-29 CC, C-1 EAST / C-1 WEST	38089.795396	\$ 34,376,000.00
S125	C-13 WEST	15322.8794	\$ 34,376,000.00
S700	C-100 EAST / C-100 WEST	25085.83454	\$ 34,376,000.00
S79, S79_LOCK	WEST CALOOSA HATCHEE	349589.7829	\$ 34,376,000.00
SR29_1	BARRON RIVER	29690.7493	\$ 34,376,000.00
TOTAL			\$ 1,890,680,000.00

Self-Preservation Mode at Critical Structures, Coastal Structures Enhancement, and Storm Surge Protection



This resiliency project is mainly tied to the District’s mission to provide flood control and water supply protection.

Implementation of self-preservation mode at water control structures means building or retrofitting structures with systems that make the structure and its operation more resilient. A self-preservation mode system includes a backup system that can be programmed to operate the structure appropriately and independently without

the direct control of water managers. Adding self-preservation mode capabilities to critical water control structures will allow water managers to manage the system for flood control, water supply, environmental restoration, and saltwater intrusion prevention, even when communication with the structure is lost due to weather or other circumstances.

Currently, in advance of storm onslaught, storm surge modeling predictions are compared to the finished floor elevations of the coastal structures to determine which finished floor elevations are below the predicted surge elevation. District staff then disable the power and backup generator with the structure gates fully open to avoid permanent damage to the electrical system, which could occur if the structure were energized during the predicted storm surge event. This so-called “structure lockout” is performed with the gates open to reduce the risk of damage to the structure and so that storm-generated runoff can pass through the structure even if the gates are no longer operational. However, this procedure also allows smaller storm surge events to pass through the structure and propagate upstream when it could have potentially been blocked by closing the gates.

Manually operated structures require that decisions to release water be made long before storm impacts affect a given area. Water releases from non-automated structures must be done while it is safe for staff to visit the site to implement pre-storm operations. Automated structures allow water managers to delay water releases until they are warranted, which can help to avoid over-draining the area upstream, particularly when storm conditions do not occur as originally predicted. Structures with self-preservation mode capabilities can mitigate the consequences of a change in a storm’s path because they allow more flexible operational strategies. Structures with self-preservation mode capabilities can preserve

environmentally sensitive lands and prevent damage to stormwater treatment areas caused by over-draining the area unnecessarily. Structures with self-preservation mode capabilities can also help avoid prolonged drought conditions that can occur when water is released late in the wet season in anticipation of a storm that does not materialize.

Once self-preservation features are added to critical structures, gates will continue to be operable during the initial onslaught of the storm, well after it is no longer safe for personnel to travel to the site to manually disable the power and backup generator. Additionally, adding an independent system override to the gate controls and/or a pre-hurricane-initiated program to the local Remote Terminal Unit (RTU) and/or Backup Controller (BUC) so that the structure will operate as desired even if communications are lost. For example, if the tailwater stage reaches a specific pre-determined high elevation, the structure will shut itself off by going into a lockdown mode that first opens all gates and then shuts off commercial power and disables the generator.

SELF-PRESERVATION MODE FOR COMBATting STORM SURGE DAMAGES AND SALTWATER INTRUSION AT COASTAL WATER CONTROL STRUCTURES

- Maximizing the operational capacity at critical water control structures
- Determination of elevation to extend gates to prevent reverse flow during a non-storm related extreme high tide or minor storm
- Optimizing the time to open and close gates before storm surge inundates critical equipment and/or damages the structure
- Avoiding unnecessary lockouts

The coastal structures were originally intended to provide a barrier to reduce saltwater intrusion without increasing flood risk from rainfall in the basin. They were not designed to provide robust storm surge protection; however, some surge protection can be achieved during less significant events. Therefore, the ability to operate structure gates for an extended period into a storm event is desirable. In many cases, the tops of structure gates can be extended to maximize the ability to protect against storm surges. The elevation for self-preservation mode to begin the lockdown procedure should be higher than a non-storm related extreme high tide which may already result in reverse flow over the closed gates, but low enough to allow time for all gates to open fully before the storm surge inundates critical equipment that could be damaged due to pressure on closed gates. The infrastructure to accomplish this must be hardened such that it is not susceptible to damage from windblown debris and/or storm surge. The lockdown would be lifted manually by District staff sent to the site to evaluate any damage to the mechanical and electrical systems after the all-clear has been issued after a storm event. Like the current pre-storm lockdown, after

the storm has passed, if damage has occurred, the gates would remain open or be operated by alternate means (portable generator, crane, other temporary measures) until repairs have been completed.

The District will prioritize the implementation of a self-preservation mode system that will enhance electrical components and sensors in critical coastal structures to maximize operational capacity and minimize the time gates need to be locked in the open position, given anticipated storm surge scenarios. Considering recently observed and projected increases in frequent storm surges/ high tailwater conditions, maximizing the operational flexibility of coastal structures is necessary for optimal flood control and prevention of saltwater intrusion. Implementing self-preservation mode infrastructure is a relatively inexpensive investment that can pay dividends. The majority of District controlled structures already have backup generators (the most expensive component), and therefore they only need automation components such as hardened sensors, communication equipment, and computer systems added.

Other strategies that the District considers to be related to the self-preservation concept include maximizing the operation of the secondary flood control system, increasing the ability to transfer water between basins and also optimizing the operation of stormwater treatment areas (STAs), and enhancing automation so that drawdowns can be avoided when not necessary.

STAs depend on certain hydrologic conditions (water levels) to optimize nutrient removal because aquatic plants require a certain water level range to grow and thrive. When the water level in an STA is kept within the optimal range, the STA can operate most efficiently. Drastic changes in water level can severely impact the efficiency of an STA and can even cause aquatic vegetation to die, thus turning an STA into a nutrient source instead of a nutrient sink. Adding remote control and automation to the pump stations that control water levels in STAs helps to ensure that water levels are kept at their optimal range even when a power failure occurs at the pump station and avoid unnecessary drawdown operations when storm prediction is highly uncertain.

Maximizing the operation of the secondary flood control system is another way to increase the resiliency of the C&SF System. For instance, the primary system (C&SF Project) may be operating at maximum efficiency, but if a secondary water control structure is clogged with debris or has suffered a power outage, flooding upstream of the secondary structure can occur. The District is committed to partnering with the entities that operate secondary water control systems to make modifications to the secondary systems that increase the resiliency of the entire flood control system.

Another strategy that is promising for making the C&SF Project more resilient is increasing connectivity between basins. Having the ability to move water from a flooded basin to an adjacent basin that can

handle additional water could be a very effective tool that does not require discharging to the tide. With increased connectivity between basins, water managers could have powerful additional tools for operating the system to optimize flood control efforts.

Table 9-7 summarizes the self-preservation actions needed at each prioritized C&SF structure, and initial estimated costs to implement additional programming costs, and backup controller instrument and platform; install backup controller and other automation features; modify gates for added high tide protection against reverse flow, according to the number of gates in each selected coastal structure; modify structure by adding seals and additional needs. In FY2023, this project was awarded 100% of funding needs through FDEP Resilient Florida Program, and a contract is currently under negotiation.

Table 9-7: Modifications and costs needed to harden coastal structures.

ID	Name	Additional Programming; Storm Resilient Back Up Controller instrument and platform	Install Backup Controller and other automation features	Modify gates for added high tide protection against reverse flow	Modify Structure by adding seals*	Control Panel Upgrades / Hardening
1	S-123 (2)	\$150,000.00		\$100,000.00	\$50,000.00	
2	S-22 (2)	\$150,000.00		\$100,000.00		
3	S-27 (2)	\$150,000.00		*4		
4	S-28 (2)	\$150,000.00		*4		
5	S-21 (3)	\$150,000.00		\$150,000.00	\$75,000.00	
6	S-25 (1)	\$150,000.00		\$50,000.00		
7	S-20 (1)	\$150,000.00		\$50,000.00		
8	S-20F (3)	\$150,000.00		\$150,000.00		
9	S-20G (1)	\$150,000.00		\$50,000.00		
10	S-21A (2)	\$150,000.00		\$100,000.00		
11	S-25B (2)	\$150,000.00		\$100,000.00		
12	S-26 (2)	\$150,000.00		\$100,000.00		
13	S-29 (2)	\$150,000.00		*4		
14	S-197 (4)	\$25,000.00				
15	G-56 (3)	\$150,000.00		\$150,000.00		
16	COCO1		\$175,000.00			
17	GG-1		\$175,000.00			
18	HC1		\$175,000.00			
19	COCO2		\$175,000.00			
20	GG2		\$175,000.00			
21	COCO3		\$175,000.00			
22	GG3		\$175,000.00			
23	S487, S486, S488					\$3,050,000.00
24	G-420					\$600,000.00
25	G-57, S-381					\$300,000.00
26	Manatee Gates*2					\$5,000,000.00
27	S140, S7					\$1,000,000.00
28	S-179*3					\$500,000.00
*1 This option will replace the need to raise the heights						
*2 G-36, S-127, S-131, S-33, G-93, S-123, S-22, S-25, S-25B, S-26, S-27, S-28, S-29, S-20F, S-20G, S-21, S-						
*3 Gate Hoist Conversion						
*4 Gates modifications are included in the major refurbishment proposals for these Coastal Structures						

L-8 FEB / G-539 Pump Resiliency Upgrades

This resiliency project is mainly tied to the District’s mission to provide flood control and water supply protection. The L-8 Flow Equalization Basin (FEB) consists of a 3,000 cubic feet per second (cfs) inflow structure and a 450 cfs outflow pump station G-539. The L-8 FEB is located along the L-8 Canal in Palm Beach County and receives flows from the C-51 West and S-5A drainage basins that were previously routed to STA-1W and STA-1E for treatment prior to discharging into Water Conservation Area 1. The S-5A and S-319 Pump Stations continue to provide the existing level of flood protection to the S-5A Basin and the C-51 West Basin, with the FEB, adding an additional 45,000 acre-feet of storage capacity that reduces flows to tide during storm events or sending water south when the system is at capacity by attenuating peak flows. This project includes the refurbishment of a regionally significant asset, the G-539 pump and the L-8 FEB, to reduce the impacts of flooding and sea level rise throughout the C-51 and S-5A drainage basins by enhancing the pump operation that will attenuate peak flows of tide during storm events, providing stormwater management to areas beyond a single municipality boundary. This project replaces the six existing electrical submersible pumps configured in 2 pumping stages to reduce the total static head on each pump. Replacement pumps will ensure the reliability and resiliency of flood protection and flood attenuation.

This project will enhance the reliability of the G-539 pump, resulting in reduced flood risks and increased water management flexibility. The project consists of the replacement of six existing electrical submersible pumps configured in two pumping stages (total static head reduction). The L-8 FEB receives flows from C-51 West and S-5A drainage basins and adds 45,000 acre-feet of storage capacity that reduces flows to tide during storm events or sends water south when the system is at capacity, which allows for peak flow attenuation benefits. Self-Preservation Mode will also be implanted so that the control room will be able to monitor each engine of the pump station. Replacement pumps will ensure the reliability and resiliency of flood protection. Water supply protection benefits are also expected through the operation of the C-51 reservoir.

Current efforts from the Flood Protection Level of Service Program (FPLOS) to develop a comprehensive assessment and understand the frequency and severity of flooding in the project impact area, in Palm Beach County, for current and future scenarios are undergoing. Extreme rainfall events (i.e., Irma, September 2017; May 2020 Storm; Tropical Storm Eta, November 2020) have caused flooding conditions of different magnitude across Palm Beach County, and flood reports display different degrees of severity, from ankle-deep flooding to 2 feet. The L8 FEB G539 Pump project is key to improving flood attenuation and helping reduce the vulnerability of communities in the C-51 East and C-51 West Basins. In FY2023, this project was awarded 100% of funding needs through FDEP Resilient Florida Program, and a contract is currently under negotiation.

L-8 FEB / G-539 Pump Resiliency Upgrades	\$8,000,000
--	-------------

Hardening of S-2, S-3, S-4, S-7, S-8 Engine Control Panels – Building Resiliency in Water Management South of Lake Okeechobee

The S2, S3, S7, and S8 pump stations were built in the 1950s, and S4 was built in 1975. The purpose of the S2, S3, and S4 structures is to pump water into Lake Okeechobee via the Hillsboro and NNR Canals, the Miami Canal, and L-D1, C-20, C-21 and Industrial Canals, respectively, from the agricultural area south of the structure. The S7 and S8 provide a hydraulic gradient for discharges from STA-3/4.

The pump engine monitoring panels and equipment at these pump stations are at the end of their useful service life, limiting the capacity of the pump station operator to take critical actions necessary to prevent the failure of a pump engine. Replacement parts for the existing monitoring equipment/control panel are not available. The District routinely performs inspection reports to assess the immediate enhancement needs. This project is one of the priority needs established to increase the resiliency of water resources in this region.

Failure of S2, S3, S4, S7, and S8 structures to pump water exceedances to Lake Okeechobee will result in cascading effects downstream, such as the increase in the water levels in canals, reduction in infiltration capacity, wet antecedent conditions in watersheds and higher water tables that are likely to increase flooding conditions in urban areas in Palm Beach and Broward Counties. Floodwaters are likely to propagate across the agricultural areas towards WCA 2A or 3A, ultimately reaching the C11 and C9 urbanized areas or the Everglades National Park.

With the goal of increasing flood resiliency within its impact area, this proposed project is to replace all engine control panels in these five pump stations with modern and standardized equipment and to install equipment to implement new emergency shutdown features. These pump stations are critical features of the stormwater infrastructure and need to be upgraded. The pump engine needs enhancements to reduce flooding risks and increase water management flexibility. The engine control panel updates will improve the efficiency and reliability of these structures. Finally, this project will reduce the risk of compound flooding across Palm Beach and down South in Broward County.

In FY2023, this project was awarded 100% of funding needs through FDEP Resilient Florida Program, and a contract is currently under negotiation.

Hardening Of S-2, S-3, S-4, S-7, S-8 Engine Control Panels – Building Resiliency in Water Management South of Lake Okeechobee	\$17,000,000
---	--------------

JW Corbett Wildlife Management Area Hydrologic Restoration and Levee Resiliency

Background



This resiliency project is mainly tied to the District’s mission to provide flood control, water supply protection, and ecosystem restoration. In August of 2012, Tropical Storm Isaac brought unprecedented rainfall to areas of central Palm Beach County, resulting in widespread flooding in the area. As part of the State’s response to the Storm, the Indian Trail Improvement District’s (ITID) Corbett Levee was identified as an area of critical concern for berm

failure due to localized slope failures, excessive seepage, and the formation of boils (seepage pathways).

In September 2012, the SFWMD was directed by the Governor’s Office to immediately convene a multi-agency working group to develop a plan for strengthening the Corbett Levee to meet current USACE and South Florida Water Management District standards and to increase the level of flood protection in the area for over 40,000 residents. The project was designed and constructed by the District following the latest engineering and construction technologies. The first phase of the project included strengthening and upgrading 2.6 miles of levee along the north side of ITID, starting east of the ITID Reservoir. However, the remaining eastern levee section of 3.7 miles has not been constructed due to a lack of funding.

Therefore, the project is currently not meeting its full flood protection and habitat enhancement potential.

Corbett Wildlife Management Area

Corbett Wildlife Management Area (Corbett WMA), upstream of the Levee, consists of approximately 60,000 acres of cypress swamp, pine flatwoods, sawgrass marsh, and hardwood hammocks adjacent to the L-8 canal and upstream of the C-51 canal. The Corbett WMA is home to many wildlife species, including deer, turkey, and feral hogs that draw hunters, as well as threatened and endangered species like the red-cockaded woodpecker, Everglade snail kite, gopher tortoise, and indigo snake. Other notable species that are frequently encountered include bobcats, sandhill cranes, and numerous wading birds and waterfowl.

The Corbett WMA has been held at artificially low water levels for years, resulting in fish and wildlife habitat loss. Additionally, holding water levels at lower elevations requires increased discharge of stormwater into the regional system, thereby diminishing the capacity for flood control in areas adjacent to and downstream of the Corbett WMA. Completion of construction of the Corbett Levee would allow water managers to restore a more natural hydroperiod and therefore improve wildlife habitat within the

Corbett WMA while simultaneously increasing the resilience, storage capacity, and functionality of the flood control system. This is particularly beneficial to create wildlife corridors and habitat connectivity within the C-18 Basin and nearby areas close to Lake Okeechobee.

Loxahatchee River Watershed Restoration Project

The Loxahatchee River Watershed Restoration Project (LRWRP) will restore 10,000 acres of existing disturbed wetlands in the J.W. Corbett Wildlife Management Area (WMA), Loxahatchee Slough, Pal-Mar East, Cypress Creek Natural Area, and Kitching Creek. Specifically, the LRWRP will restore 1,642 acres of wetlands within the J.W. Corbett WMA.

Completion of the Corbett Levee will provide flood protection to adjacent residential communities and ecological benefits that are consistent with the planning objectives of the LRWRP. The planning objectives include restoring water flows to the National Wild and Scenic Northwest Fork of the Loxahatchee River, increasing the natural area extent of wetlands within the watershed, restoring connections between natural areas to improve hydrology and natural storage, and restoring native plant and animal abundance and diversity within the natural areas of the Loxahatchee River Watershed.

The Corbett Levee will retain additional freshwater within the J.W. Corbett WMA that can be used to supplement the C-18W Reservoir and ASR well system to provide additional flow to the Loxahatchee River. The Corbett Levee will also enhance storage capacity in J.W. Corbett WMA, which will improve hydroperiods for wetland communities. An improved hydroperiod will benefit wetland habitat and function, which further strengthens the connectivity between adjacent natural areas within the LRWRP.

Flood Protection

In addition, the completion of this project will address excess flooding due to the impacts of climate change, such as an increase in the number and intensity of tropical cyclones. The urban areas adjacent to the Corbett Levee highly rely on the ability of the inner canal system to drain water to the M-O canal. Flooding conditions as a result of channel overbank flow diminish the drainage capacity of the system, exacerbating flood inundation depth and extent across the basin. For instance, rainfall impacts from Tropical Storm Isaac were well beyond the design capacity of the berm that existed prior to the construction of the Corbett Levee. Finishing this project would increase the District's operational flexibility and therefore improve the system's resiliency to flooding.

The proposed final section of the levee is approximately three miles long. In addition, the project proposes the concurrent construction of a 0.6 N/S levee portion that is part of the CERP Loxahatchee Project - C18-W Impoundment Project (L-101W, 0.6-mile segment from the east end of ITID's M-O

Canal to 100th Ln North) to allow full operational change to JW Corbett WMA. Total project costs below include the 0.6-mile segment, which will be built as a separate project. Without the north-south segment, the operational changes to Southeast JW Corbett WMA will be limited. IN FY2023, Palm Beach County was awarded 100% of funding needs through FDEP Resilient Florida Program, and the contract is currently under negotiation, including an interagency agreement with the District for the construction of the project.

Bahiagrass Pilot Study

Landscape turf represents a major draw on Florida’s water resources, and it requires intensive maintenance such as mowing and fertilization. Bahiagrass requires very little supplemental irrigation and fertilization. This proposed pilot study would be located on the Corbett Levee. The goals of the study are:

- Retain the persistence and resilient nature of bahiagrass.
- Improve the color and density of bahiagrass to increase its utilization in landscapes and therefore reduce the need for fertilization and irrigation.
- Increased seed yield during fewer months of the year to increase seed production and reduce the price of seed.
- Reduce the rate of leaf elongation to reduce the need for mowing.
- Produce seed heads only in June, July, and August to concentrate seed production times and reduce the need for mowing.

To accomplish these goals, both traditional methods of plant breeding and more advanced genetic technologies/gene editing would be used.

Corbett WMA Hydrologic Restoration and Levee Resiliency Cost Estimate

JW Corbett Wildlife Management Area Hydrologic Restoration and Levee Resiliency	\$13,000,000
---	--------------

C-29, C-29a, C-29b and C-29c canal conveyance improvement

This resiliency project is mainly linked to the District’s mission to provide flood control. The C-29, C-29A, C-29B, and C-29C Canals are part of the Lake Hart basin in Orange and Osceola counties. The C-29 canal is 1.1 miles long and connects Lake Hart with Lake Mary Jane. The direction of flow in the C-29

canal is generally from Lake Mary Jane to Lake Hart. C-29A canal, which is 1.5 miles long, connects Lake Hart with the downstream Ajay Lake, the C-29B canal connects Ajay Lake with Fells Cove, and the C-29C canal connects Fells Cove with the downstream East Lake Tohopekaliga.



The S-62 structure in the C-29A canal at the outlet

of Lake Hart regulates the lakes, Hart and Mary Jane. The regulation schedule ranges between 59.5 feet and 61.0 feet NGVD and the design discharge of the structure is 450-640 cfs. Lake Ajay, Fells Cove, and East Lake Tohopekaliga are regulated by the S-59 structure located in the C-31 canal at the outlet of Lake Tohopekaliga. The lakes are maintained between 54.5 and 59.0 feet NGVD. As a result of Hurricane Ian's heavy rainfalls, equivalent to more than 200-year recurrence frequency for the region, water levels at Lake Mary, Lake Hart, and Ajay Lake stayed above the safe development line stages for approximately 20 days, as illustrated above, showing Lake Hart Stages. A total of 75 cfs of temporary pumping capacity was operated at Lake Hart during Hurricane Ian's response.

As part of response actions, it is recognized that canal conveyance capacity needs to be closely reassessed, and appropriate mitigation measures need to be developed. Overall recommended strategies include widening, deepening the canal, and/or elevating the canal banks and providing appropriate canal benches and berms. The currently proposed measures for improving conveyance at C-29, C29-A, C29-B, and C29-C canals include dredging the canal for deepening and widening, adhering to the 1:3 slope, up to the existing extension of the District’s right of way. Canal bank stabilization is not included in this initial

project recommendation and respective cost estimates. Canal bank stabilization will be done in a future phase of this project, with an estimated cost of up to \$5M per mile.

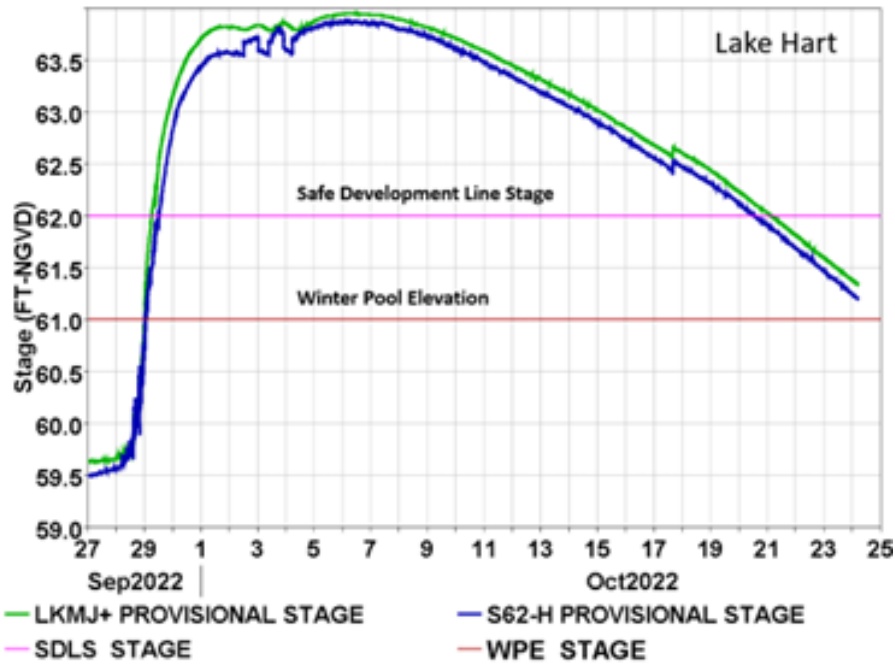

Lake Hart Water Stages resulting from Hurricane Ian's heavy rain fall event.

Figure 9-20: Lake Hart Water Stages

C-29, C-29A, C-29B AND C-29C Canal Conveyance - Cost Estimate

C-29 Dredging (0.5 miles widening and deepening)	\$ \$1,279,270
C-29A Dredging (1.41 miles widening and deepening)	\$ 3,249,152
C-29B Dredging (1.06 miles widening and deepening)	\$ 2,499,975
C-29C Dredging (0.77 miles widening and deepening)	\$ 1,851,267
Total Construction Cost	\$ 8,879,664

S-59 Structure enhancement and C-31 canal Conveyance Improvements

This resiliency project is mainly tied to the District’s mission to provide flood control. The S-59 structure is a gated spillway on the C-31 canal at the outlet of East Lake Tohopekaliga in Osceola County in the Upper Kissimmee Chain of Lakes. The structure can be remotely operated from the SFWMD Operations control center. The structure has a design capacity of 590-820 cfs and is operated to maintain optimum stages in the upstream C-31 Canal and in East Lake Tohopekaliga. The structure is operated in accordance with USACE Master Water Control Manual for Upper and lower Kissimmee basins, focusing on the East Lake Tohopekaliga Regulation

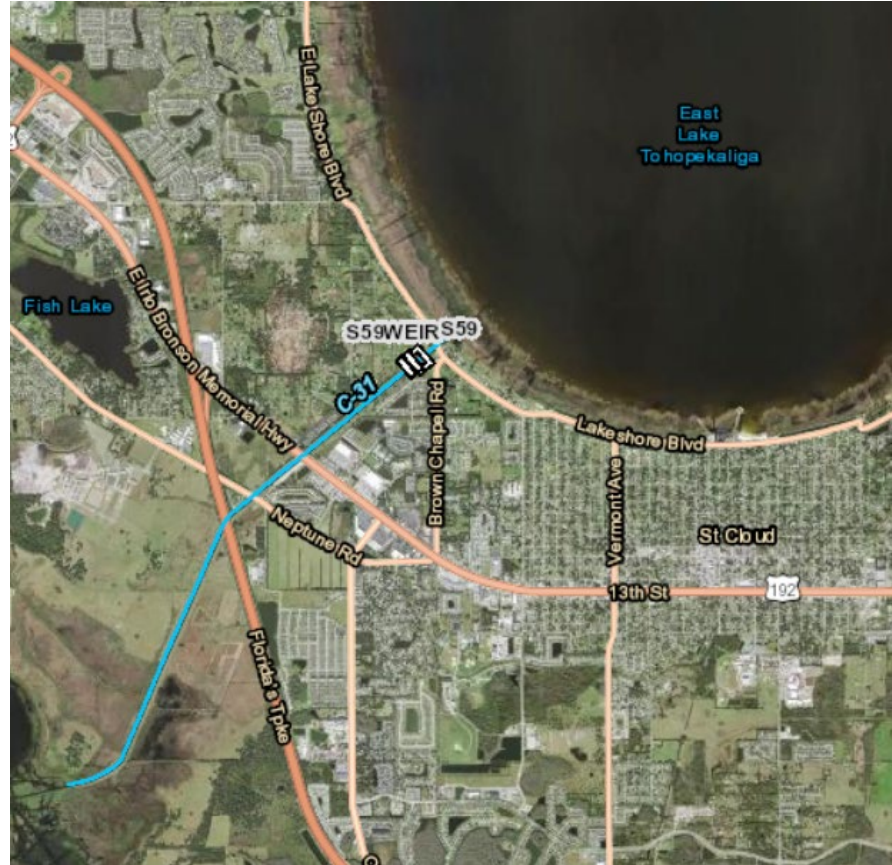

Schedule, which ranges between 55.0-58.0 feet NGVD. The C-31 canal is 3.9 miles long and connects East Lake Tohopekaliga to the downstream Lake Tohopekaliga to the south. The C-31 canal design elevations are 52.0-55.0 feet NGVD. The two major sources of inflow to Lake Tohopekaliga are Shingle Creek and C-31 Canal.

As a result of Hurricane 2022 Ian’s heavy rainfall, equivalent to more than 200-year recurrence frequency for the region, water levels at East Lake Toho stayed above the safe development line stage of 59 feet NGVD for approximately 25 days. During Hurricane Ian, temporary pumps were deployed to facilitate the conveyance between East Lake Toho and Lake Toho for the period of 10/01/22 to 10/31/22, with daily flow rates as high as 290 cfs.

As part of response actions, it is recognized that this structure needs to be upgraded to include an additional gate to address the single-gate vulnerability issue, along with an improved erosion protective

measure that would not constrain the capacity at this structure and canal conveyance improvements. The currently proposed measures include removing the existing structure and adding 2 (two) gated spillways and enhancement of the sheet pile weir with a more robust stilling basin with flow deflector and associated rip rap. Such design would remove major structure capacity limitations and potentially can result in a structure that has no maximum Allowable Gate Openings (MAGOs) constraints. Additionally, conveyance improvement along the C-31 conveyance is being proposed, especially as C-31 enters Goblet Cove in West Lake Toho and includes canal dredging (deepening) and riprap augmentation. The Osceola Parkway expansion project includes widening the Partin Settlement Rd near C-31 Canal, and Coordination with FDOT is recommended.

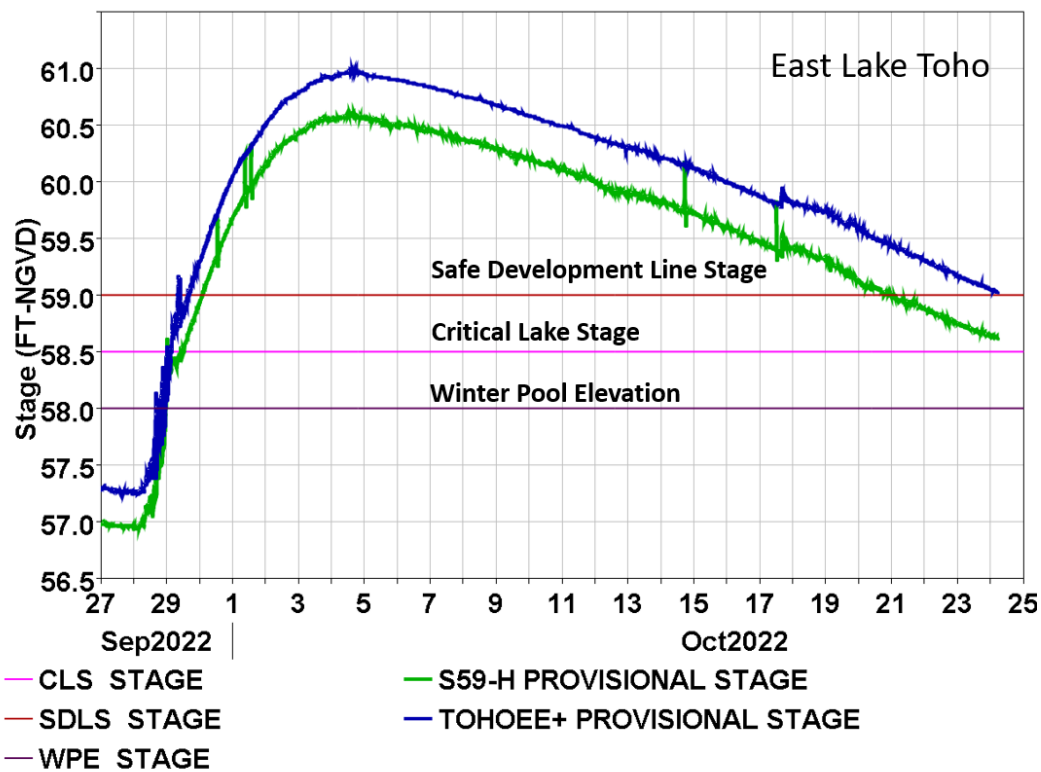

East Lake Toho Water Stages resulting from Hurricane Ian's heavy rainfall event.

Figure 9-21: East Lake Toho Water Stages

Erosion Control at S-59 and C-31 Conveyance Improvements Cost Estimate

Demolish old Structure and Build a New Spillway	\$23,731,532
S-59 Electrical Work	\$743,497
C-31 Canal Widening, Including Rip Rap Work	\$8,412,576
Total Construction Cost	\$32,887,605
Total Construction Cost	\$39,308,208

S-58 Structure Enhancement and Temporary Pump

This resiliency project is mainly tied to the District’s mission to provide flood control. The S-58 culvert structure with two barrels is located in Osceola County on the C-32C canal, 3700 feet downstream from Lake Trout, connecting Lakes Trout and Joel. Flow is south to north in the C-32C canal, and the structure maintains stages in the range 62.0 – 64.0 feet NGVD in accordance with the Lake Alligator Regulation schedule. The structure, which has a design discharge of 160 cfs, was originally designed to pass sufficient discharge during dry periods to maintain downstream stages and water supply demands. S-58 Structure is currently the only structure in the main canals in this region that does not have the ability for remote operation.

As a result of Hurricane Ian’s heavy rainfall, equivalent to more than 200-year recurrence frequency for the region, water levels at Alligator Lake stayed near the safe

development line stage of 65 feet NGVD for approximately 3 days. During Hurricane Ian, temporary pumps were deployed to facilitate the discharge to Alligator Lake for the period of 10/01/22 to 10/12/22, with daily flow rates as high as 316 cfs.

As part of response actions, it is recognized that this structure needs to be upgraded along with the need to augment the S-58 structure with a pad for a temporary pump station to alleviate flood conditions between Lakes Myrtle and Alligator. The region is under intense land development and a rapidly growing population that needs to be provided with compatible flood control and operation capacity. The currently

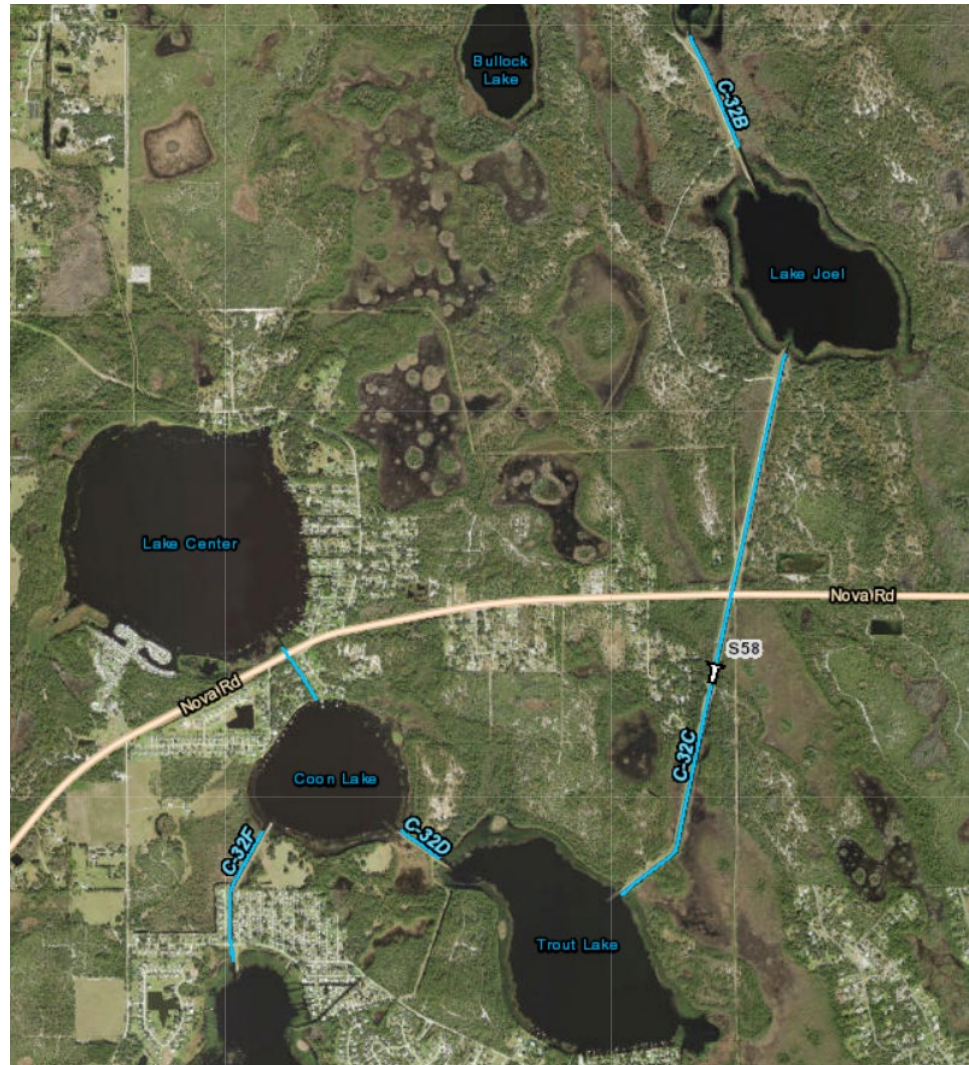

proposed measures include removing the existing structure and adding 2 (two) gated spillways with fully remote operation capability, along with the permanent installation of pump platforms to make temporary pump deployment quicker/easier and the purchase of two-way temporary pump(s) to have on hand for deployment. Pump capacity should take into consideration canal limitations downstream, as C-32 Canal might not be able to handle more than 250cfs. Platforms should be constructed in a way that allows pump deployment from both directions.

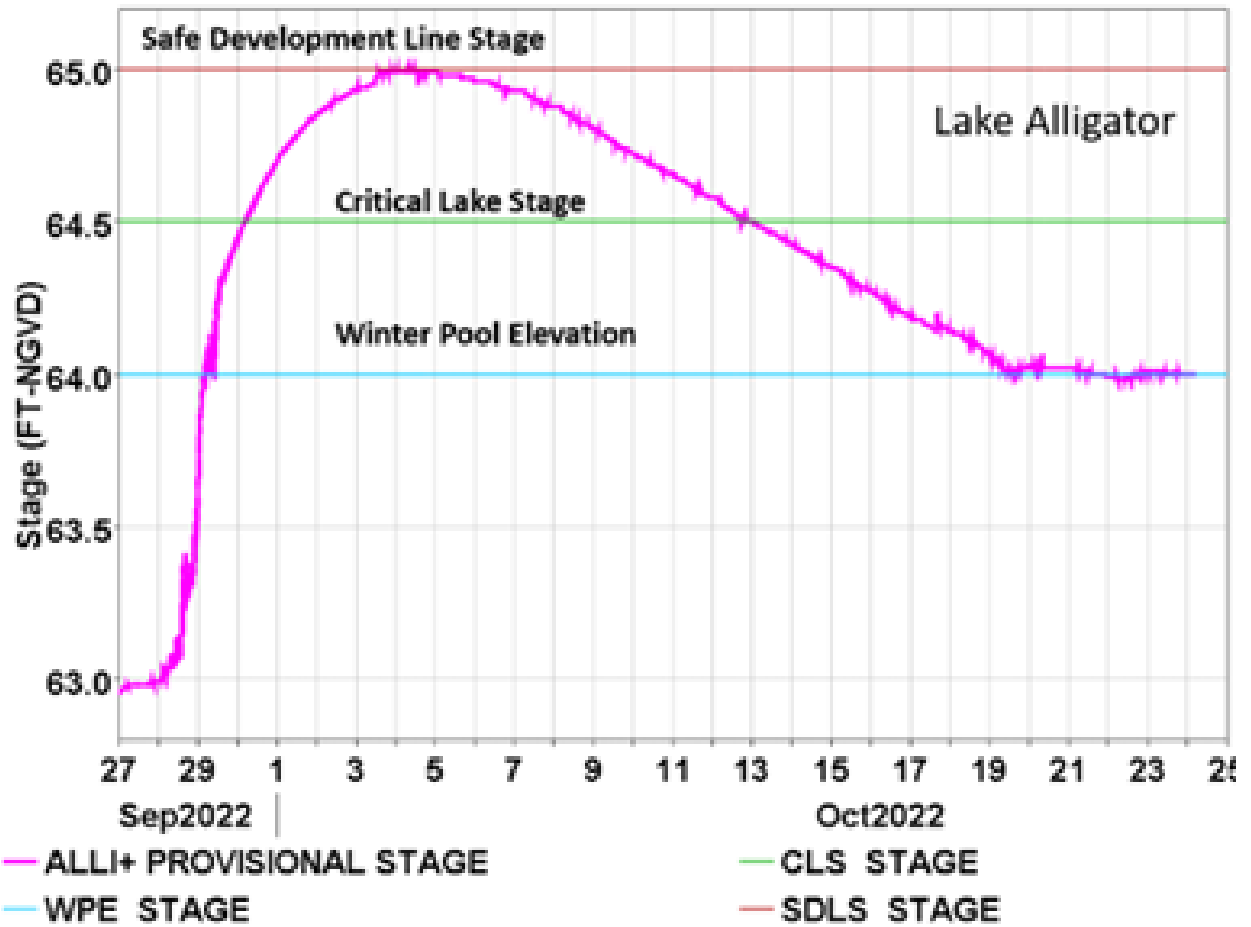

Lake Alligator Water Stages resulting from Hurricane Ian's heavy rainfall event.

Figure 9-22: Lake Alligator Water Stage

S-58 Structure Enhancement Cost Estimate

Removal of the existing structure	\$4,568,189
Addition of 2 (two) gated spillways with fully remote operation capability	\$31,346,062
Purchase of two-way temporary pump(s) and permanent installation of pump platforms	\$6,631,180
Total Project Cost	\$42,545,431

S-61 Spillway enhancement and erosion control

This resiliency project is linked to the District's mission to provide flood control. The S-61 lock is 90 feet by 30 feet with two pairs of gates and permits passage of vessels between Lake Tohopekaliga and other canals/lakes downstream all the way to Kissimmee River. It is operated for flood control when the Lake Toho stage exceeds 48.5 feet NGVD. The S-61 lock was not designed for flood control purposes; however, it is used to supplement the S-61 spillway flow capacity to pass floodwater during major storms and emergency response. This is a delicate operation that must be closely monitored and appropriately coordinated with the U.S. Army Corps of Engineers.

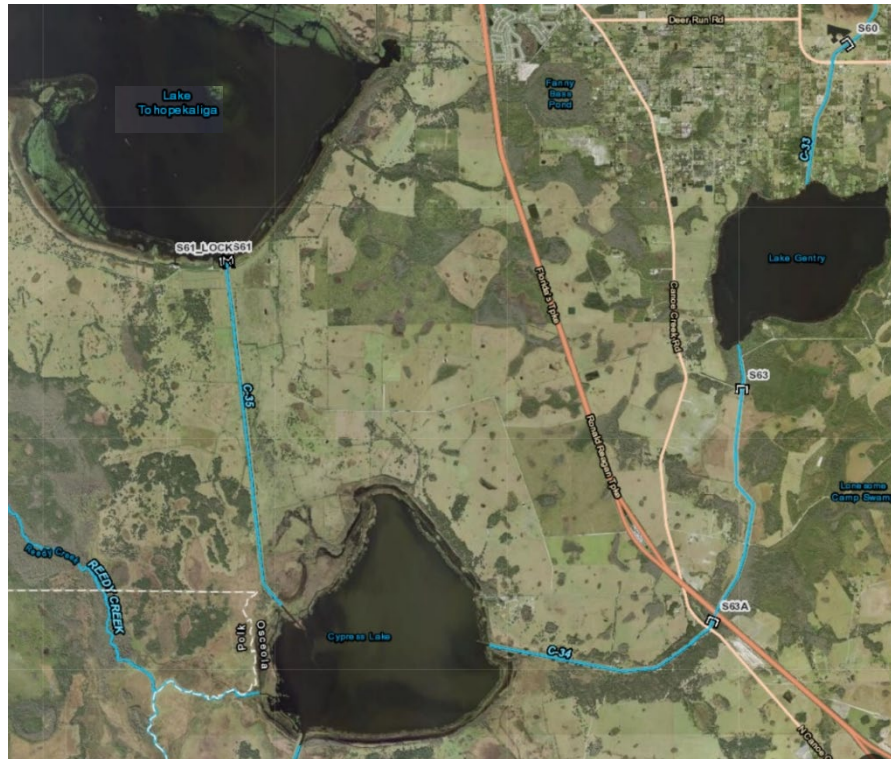

In 2017, during and after Hurricane Irma (when the lock was used for flood control operations), the scour hole downstream of this lock increased to seven (7) feet. Further erosion damage was observed during emergency response operations from Hurricane Ian.

As part of response actions, it is recognized that this navigational lock needs to be augmented with the enhancement of the S-61 Spillway to handle flood control operations during emergency events, as well as to continue serving navigation purposes. The currently proposed measures include the construction of two new gated spillways to allow for improved conveyance/discharge capacity. After completion of the new spillway, demolition of the existing spillway will be performed, and rebuild the peninsula. Canal enhancement will allow for flow to be directed to the new structure, along with proper erosion control measures and sloped rip rap on the south side of the structure.

Additionally, the area downstream of the S-61 Lock needs to be redesigned and repaired with appropriate erosion protection measures.

S-61 Spillway Enhancement Cost Estimate

Existing S-61 Demolition and Removal	\$4,568,189
New S-61 Two (2) Gated Spillway, including Canal Excavation	\$31,346,062
Repairing The Scour Hole in S-61 Boat Locks	\$4,113,361
Total Project Cost	\$40,027,611

Corbett Levee water control structures

This resiliency project is mainly tied to the District's mission to provide flood control and ecosystem restoration. Several existing culverts that pass through the L-8 Levee are currently owned, operated, and maintained by Florida Fish and Wildlife Conservation Commission (FWC), which could create a flood risk if failure were to occur. During Hurricane Ian, a partial failure of one of these structures occurred, requiring an emergency response to block the free flow of water from the adjacent property through the damaged culvert into the L-8. This temporary protective measure provides an earthen berm around the structure to block water from entering the L-8. The remaining culverts owned by FWC were also exhibiting failure modes with depressions in the levee crown adjacent to the structure and the initiation of failure in the sandbag wing walls.

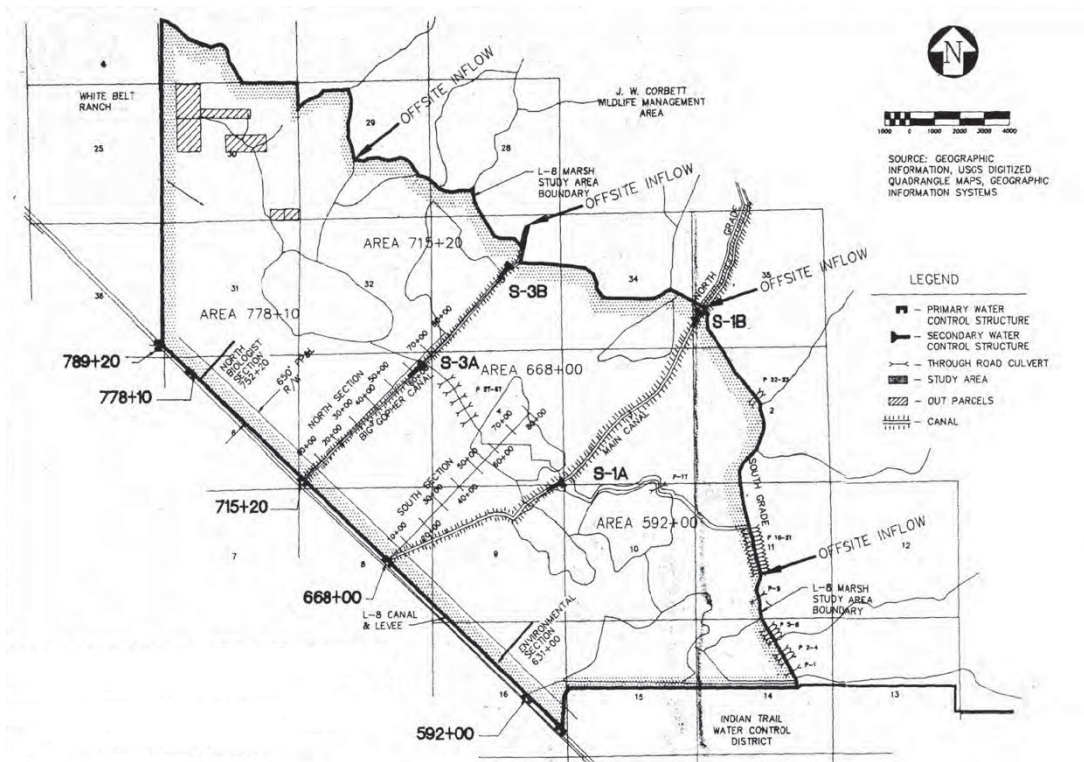

Therefore, it no longer allows normal discharge into the L-8. This could have a negative impact on the environment due to excessive stages in the adjacent property but also increases the flood risk by the potentially higher stages creating increased pore pressure against the L-8 Levee, which could then lead to higher seepage and, ultimately, the potential for a breach of the Levee if backward erosion piping were to occur. The replacement of these culverts is critical to resume normal operations and reduce these flood risks. As the entity responsible for the maintenance of the L-8 levee, it is beneficial for SFWMD to replace these and other similar structures to protect the levee and manage the appropriate stages with controlled discharges into the L-8. SFWMD is currently taking over ownership, maintenance, and operational responsibilities, which would warrant the replacement water control structures be designed to

the District's current standards, which meet the minimum life expectancies of 75-100 years rather than structures that may require replacement at 25–30-year intervals.



Note that several of these structures had originally been installed as small spillways during the construction of the L-8 but were replaced by the FWC culverts when it was identified that higher stages upstream were desired to provide environmental benefits. Returning these to the responsibility of SFWMD will continue to provide the intended environmental benefit while mitigating risks of flooding that

could be caused by the failure of the structures. The recommended project includes demolishing the existing ones and replacing the existing culverts with five new water control structures and associated riprap/erosion control. Each new structure will have a conveyance capacity of approximately 600-800 cfs. Additional work will be performed at the 9-mile road using the 60-inch lime rock.

Corbett Water Control Structures Cost Estimate

Project Construction Cost for Box Culvert 1	\$3,440,946
Project Construction Cost for Box Culvert 2	\$2,280,743
Project Construction Cost for Box Culvert 3	\$3,440,946
Project Construction Cost for Box Culvert 4	\$3,440,946
Project Construction Cost for Box Culvert 5	\$1,403,153
Construction Cost (9) Miles Road Repair at Corbett Levee	\$3,764,542
Total Project Cost	\$17,771,277

Big cypress basin microwave tower

This resiliency project is mainly tied to the District’s mission to provide flood control and water supply protection. A new Microwave Tower and Electronic Equipment Shelter will be located in Immokalee, Collier County, near Lake Trafford. This new tower is required to complete communications for flood control operations for the western spur and bring reliability and resiliency to the Big Cypress Basin area. This important project will help make flood control efforts in the Big Cypress Basin more resilient during storms and hurricanes. Currently, communications are through cell phone towers which can go offline during storm events. This leaves the District without communications and hinders operations.

Cost Estimate

Microwave Tower construction	\$7,400,000
------------------------------	-------------

L-31E Levee Improvements

This resiliency project is mainly tied to the District's mission to provide flood control and water supply protection. The proposed strategy consists of the enhancement of the L-31E Levee.

Addressing coastal structures' vulnerability to sea level rise and storm surge is a high priority in South Florida. Funding will be used to harden L-31E Levee, a



component of the 72-year-old Central and Southern Florida Project, to address storm surge risks and sea level rise vulnerability. The L-31E Levee is one of the priority projects on the District's CIP list.

Funds are needed to advance resiliency strategies to reduce the vulnerability of communities upstream of the L-31E Levee. Future modeling efforts will determine additional resiliency needs at other levee structures based on the determination of what cross-sectional change a vulnerable levee would need to provide more protection from storm surges and sea level rise.

L-31E Levee Storm Surge Study

A storm surge study was performed on the L-31E Levee to determine the level of resiliency of the levee as it currently exists, as well as to determine the levee crest elevation required to effectively counteract sea level rise and storm surge. The study was performed using a combination of ADCRIC/SWAN and Delft3D models of Biscayne Bay, information from previous studies, and using the FEMA/Taylor Engineering study of 391 synthetic storms. The L-31E Levee has six concrete spillway structures and twelve culverts. The following modeling scenarios were run as part of the storm surge study:

- No Levee and Present-day sea level
- Existing Levee Crest with open gates and present-day sea level
- Existing levee crest with closed gates and present-day sea level
- Non-overtopping levee with closed gates and present-day sea level
- Non-overtopping levee with closed gates and Sea Level Rise (SLR) + 1 foot
- Non-overtopping levee with closed gates and Sea Level Rise (SLR) + 2 foot
- Non-overtopping levee with closed gates and Sea Level Rise (SLR) + 3 foot

The study recommendations are summarized as follows:

1. Start planning and define goals for the levee, integrated with additional efforts being advanced in the region, including:
2. Return period, time horizon, sea level.
3. Start design considerations using the following:
4. 100-year surge elevation
5. Non-overtopping levee simulation
6. Present-day and Future sea level scenarios, starting at a 2ft increase.
7. Add freeboard according to FEMA and USACE guidance.
8. Gate opening has a negligible impact on crest elevation.
9. Edge effects need to be evaluated.
10. Take into consideration wave overtopping and inland drainage.

The next steps will be to draft a Project Definition Report (PDR) and Work Order Scope of Work (SOW) to request the design of an increased levee crest elevation to at least four feet along the entire levee based on the chart in Figure 9-23. The 100-year return period will be the target, plus an additional two feet per FEMA to get the levee certified. The current FEMA maps underpredict surge because the L-31E levee was neglected: the L-31E Levee adds approximately two feet to the 25-year surge and more than one foot to the 100-year surge. The L-31E Levee as-builts suggest that the levee was built with an average crest elevation of 7.5ft NGVD. The District proposes to raise the levee two feet from the current average elevation and another two feet per FEMA requirements above the 100-year return period. A rough estimate projected that approximately between \$39M to \$45M will achieve this design goal. Final design plans will provide the final recommended elevation, which might differ from the recent Study recommendation, as well as additional project features. A PDR will be developed with collaboration between the Engineering and Construction Bureau and the Resiliency Team to determine the most effective scope of work to bring the levee to a robust resiliency level for future generations. The remaining studies and the design of the levee crest elevation will be performed by a consultant.

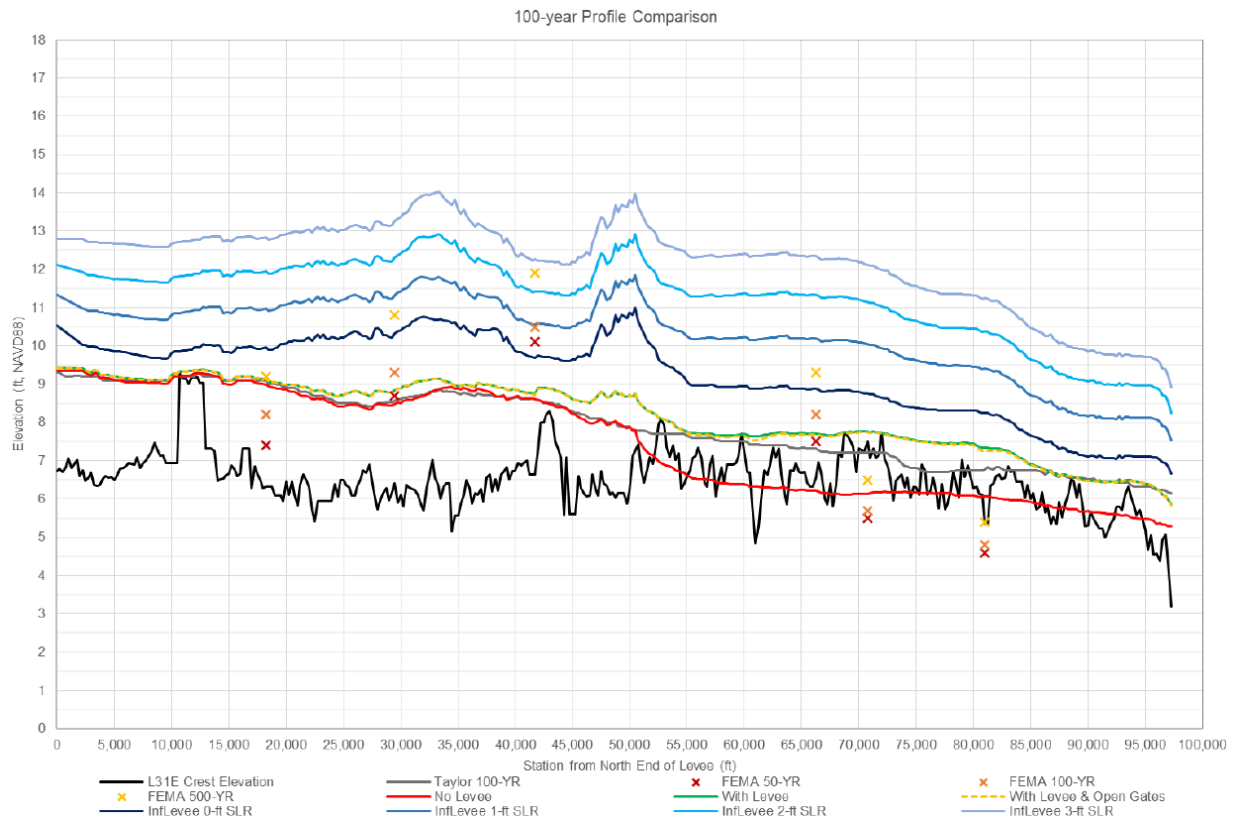

Figure 9-23: 100-Year Profile for Levee Crest Elevation Consideration

Areas of Influence

The area of influence on the south and west side of the levee is agricultural land that will need protection during storm surges and sea level rise. Going north along the levee, the Homestead Air Reserve Base is an area of influence that will need protection during storm surges and sea level rise. Further North is a mostly residential area, and they also will need protection; however, in that area of influence, the impact will be major when it comes to raising the levee crest elevation as the levee elevation coincides with the actual road. One possible solution might be to decommission two to four miles of the levee in that area. These areas of influence are depicted with the red diamonds in Figure 9-24 below. The following canals will also be affected by the levee under sea level rise: C-103, G95, C102, and C-1 since they drain the inland areas west of the levee. All these areas of influence will need to be examined closely in the additional modeling that will need to be performed to successfully design a levee crest elevation increase.

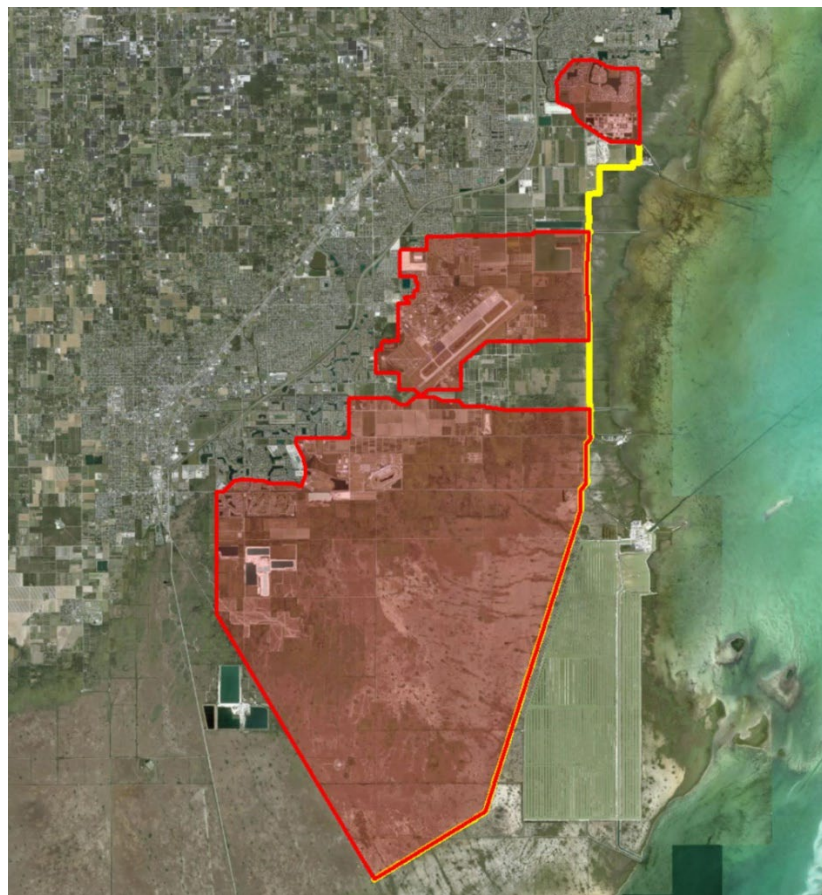

Figure 9-24: Location of L31E Levee (yellow) and area of influence (red).

L-31 Levee Cost Estimate

L31E Levee Improvements	\$39M - \$45M
-------------------------	---------------

Directing Coastal Ecosystem Resilience Phase 2: the Everglades mangrove migration assessment (EMMA)

This resiliency project is mainly tied to the District’s mission to provide flood control, water supply protection, and ecosystem restoration. EMMA is designed to capture the adaptive foundational resilience of the coastal wetlands within the SFWMD, with an emphasis on nutrient-depleted mangroves. The term “adaptive” means that this resiliency project will demonstrate the ability of coastal wetlands to adapt to rising sea levels via enhanced soil elevation change. This pilot study will evaluate and implement the ability of coastal communities to shift to foundational plant communities that are more resilient to higher water depths and salinities, which in turn, are able to accrete more peat, capture more sediments, sequester more carbon, and keep up with sea level rise. This is a foundational project because it is focused on the plant communities, such as mangrove swamps and sawgrass plains, that are endemic to the historical and extant ecology of Florida. Resilience is the ability of the foundational communities to shift rates of productivity, community structure, and spatial extent in the face of sea level rise, to minimize wetland conversion to open water habitats and maximize shoreline retention. EMMA is focused upon the hydrologic attributes needed to enhance, restore and preserve wetland function and extent, and as such, has direct relevance to water management, hydrological models, planning, and decision making.

EMMA is a large-scale landscape field manipulation of sediment and dredge material, with the potential to be incorporated into the USACE Beneficial Use Program ([The Role of the Federal Standard in the Beneficial Use of Dredged Material from U.S. Army Corps of Engineers New and Maintenance Navigation Projects \(PDF\)](#)), in the scrub mangrove ecosystem of the Model Lands, which is owned by Miami-Dade County, and is not subject to the WQ or soil nutrient constraints associated with the Everglades Forever Act. The results of EMMA will have implications for and application to all coastal wetlands of Florida that are vulnerable to sea level rise.

EMMA would take advantage of the new Thin Layer Placement (TLP) technology associated with distributing dredge spoil across an existing wetland to add elevation and, when needed, additional soil phosphorus (Berkowitz et al. 2019, VanZomeren et al. 2018). Beneficial uses of dredged material such as TLP will build landscape resiliency by improving soil aeration in the root zone, thereby increasing redox potentials (Eh), plant productivity, and soil accretion and by supplying a medium for greater carbon sequestration, which allows coastal wetlands to keep pace with sea level rise (DeLaune et al. 1990, Baustian et al. 2015).

Goals and Objectives

Changes in water management, in concert with sea level rise, have caused coastal wetlands to subside, tidal creeks to fill in (Meeder et al. 2018)), peat to collapse (Wilson et al. 2019), and plant communities to

shift to slow-growing, transgressive, open water habitats (Meeder et al., 2018). Peat collapse causes rapid declines in soil surface elevation (Chambers et al. 2019), converting wetlands from a vegetated state to an open water state (Cahoon et al. 2003; McKee et al. 2011; Baustian et al. 2012; Voss et al. 2013; Wilson 2018). In South Florida, peat collapse has been observed in sawgrass (*Cladium jamaicense*) peat marshes and coastal mangroves, which are highly organic (>85%), and depend on inputs of organic material to maintain and raise soil elevation, as they receive little inorganic sediment input (Rejmankova and Macek 2008, Chambers et al. 2019). Since changes in soil surface elevation in mangrove and sawgrass peat marshes is largely a function of primary productivity, there is growing concern that saltwater intrusion will increase coastal marsh degradation.

Without intervention, the current trajectory of sea level rise will result in significant land loss and loss of stormwater protection. Intervention that promotes accretion rates that act to maintain or outpace sea level rise in key coastal communities (e.g., those adjacent to historic tidal creeks) will result in a myriad of ecosystem and socio-economic benefits. The goal of this pilot project is to advance the understanding of biological versus physical controls on the capacity of coastal wetlands to persist under increased sea level rise. The objectives are to:

1. Develop demonstration scale evidence that supports managed wetland transgression to include sediment augmentation via a TLP strategy.
2. Evaluate the adaptive resilience of coastal mangroves to phosphorus enrichment in combination with enhanced soil elevations.

Study Design

The study will consist of three assessment locations (Figure 9-25) – the Charly Site located on the southeastern tip of the C-111 canal, the Pocket Site located along the C-111 Canal just west of the S-197 structure, and the Baby EMMA Site located just west of U.S. Highway and north of the C-111 Canal. Peat accumulation and mangrove plant growth will be measured along transects that have been elevated by TLP in comparison to mangroves that have been locally spiked with elevated phosphorus. The multifactorial design (Figures 9-26 through 28) will divide each transect into control transects and TLP treatment transects to document the costs and benefits of TLP and help establish the protocols for the effective beneficial use of dredge materials in coastal habitats. Project implementation monitoring, as detailed below, will be conducted to measure changes in soil surface elevation, quantify belowground and aboveground biomass production, and track observable changes in water quality and exchange fluxes between surface water and groundwater in the spaces between sediments – inside and outside of the study

area. It should be noted that all EMMA sites will have special sediment capture fences in place to retain sediments and prevent downstream turbidity plumes.



Figure 9-25: EMMA Assessment Locations (From left to right: Charly Site and Pocket Site)

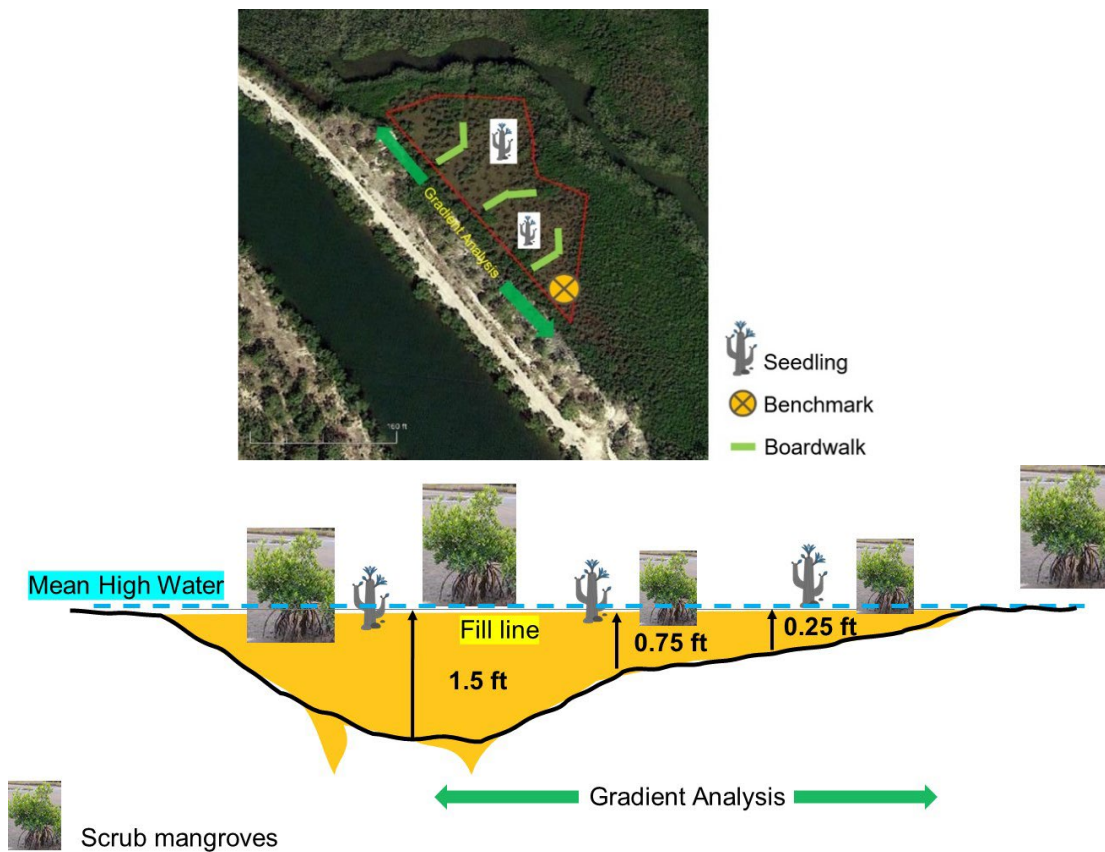

Figure 9-26: Pocket Site study design

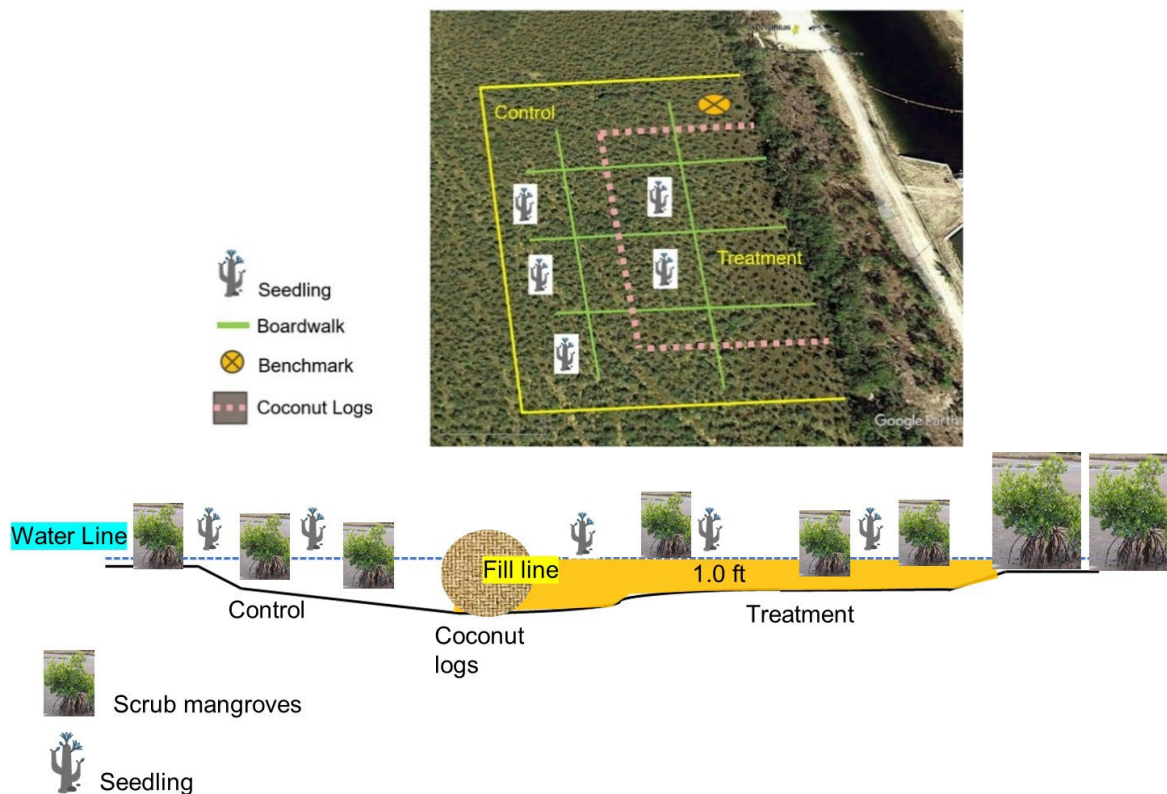

Figure 9-27: Pocket Site study design.

Permanent Benchmarks and Soil Elevation Surveys

Permanent benchmarks will need to be installed in and around the study area to preserve relevance to SL and sea level rise. Six Class “B” (Stainless Steel rod driven to refusal) NGS stability standard monuments will be established. The work will include but is not limited to processing the data, Quality Assurance, describing, typing, and reconnaissance. If no published NGVD 29 elevations were available at the site, NGVD 29 elevations would be derived from the NAVD 88 elevations by means of applying a site-wide, uniform datum shift, or offset value, of -0.456 meter (-1.496 feet). The sense of the algebraic sign of this value is NAVD 88 elevation minus NGVD 29 elevation. This value will be obtained from the NGS VERTCON model and was computed by both the NGS VERTCON Online web site (<http://www.ngs.noaa.gov/TOOLS/Vertcon/vertcon.html>, accessed May 2007, version 2.0) and by means of the software CORPSCON version 6.0.1 (which itself uses the NGS-developed VERTCON software).

The horizontal datum for this survey will be the North American Datum of 1983 (NAD 83). Soil Elevation surveys will be conducted using real-time kinematics referenced to the 1988 North American Vertical Datum (NAVD88) with Trimble R8 global navigation satellite system receiver equipment (Trimble Inc., Sunnyvale, CA, USA) with a horizontal accuracy of ± 1 cm and a vertical accuracy of ± 2 cm. Soil elevations will be set out with respect to the North American Vertical Datum of 1988 (NAVD

88) and the National Geodetic Vertical Datum of 1929 (NGVD 29). NAVD 88 elevations will be determined by differential leveling from benchmarks.

Sediment Elevation Table (SET)

The SET is an extremely accurate and precise leveling device designed to sit on a permanent benchmark pipe or rod and measure changes in elevations in inter-tidal and sub-tidal wetlands (Boumans and Day 1993, Cahoon 1995). Once installed on the benchmark, the SET establishes a constant reference plane with respect to the benchmark, allowing for repeated measurements of the sediment surface (Cahoon et al. 2002). Changes in the elevation of the soil surface over time will be measured using the surface elevation table–marker horizon (SET–MH) methodology, which has been widely used and recommended for monitoring intertidal surface-elevation trajectories in coastal wetlands (Cahoon 1995).

Biotic Monitoring: Above and belowground biomass

Mangroves are considered ‘bottom heavy plants’ as they invest much of their biomass into their root system (Komiyama et al., 2008, 2000). Mangroves have two kinds of root systems adapted to the anoxic and saline conditions of mangrove habitats: aerial roots that grow above the soil surface and belowground roots. Belowground root biomass in mangroves generally contributes up to 60% of the total tree biomass (Khan et al., 2009; Komiyama et al., 1987; Tamooch et al., 2008). It is critical that the below ground processes in this pilot study is understood. At each plot, duplicate root cores (that is, sampling units; 0–45 cm depth; shallow root zone) will be randomly collected using a PVC coring device (10.2 cm diameter 94.5 cm length). Roots will be sorted into diameter size classes of less than 2 mm, 2–5 mm, and greater than 5 mm (fine, small, and coarse roots, respectively). Each root sample will be oven-dried at 60 °C to a constant mass and weighed.

Composition, tree density, and basal area in tall and scrub mangroves will be quantified through measurements of the species and diameter at 1.3 m height (DBH) of all trees rooted within a designated study plot, which will be 154 m² (radius of 7 m). Similarly, due to the lower density of the scrub mangroves, tree density, and biomass will be measured in six 2 m radius plots. The diameter of trees of *R. mangle* will be measured at the main branch, above the highest prop root. In scrub mangroves, the diameter of the main branch of the tree will be measured at 30 cm from the ground (D30).

Water and Soil Analysis

Soil carbon and nutrients: At each plot, soil samples for bulk density and nutrient concentration will be collected using a peat auger consisting of a semi-cylindrical chamber of a 6.4 cm radius attached to a cross handle. Soil cores will be systematically divided into depth intervals of 0–15 cm, 15–30 cm, 30–50

cm, and 50–100 cm. Root and soil samples will be analyzed for Total Carbon, Total Nitrogen, and Total Phosphorus.

Porewater turbidity and salinity, and soil chemistry, may change during this study and may accretion rates as they relate to belowground and aboveground biological production. Interstitial chemistry and physical properties will be analyzed by extracting water from the ground at 30 cm using a syringe and an acrylic tube. The syringe was rinsed twice before obtaining a clear water sample, from which salinity was measured using a YSI-30 multiprobe sensor.

Surface water chemistry. To monitor possible impacts on water quality downstream from TLP, surface water samples will be analyzed to identify any changes to physical and chemical properties over time.

Schedule and Costs:

Total costs, shown below, do not reflect the current efforts to integrate this pilot study with (1) funding from the USACE Regional Sediment Management (RSM) Division to locate and distribute TLP spoil materials or (2) funding from the National Science Foundation, given to FIU for its Long-Term Ecological Research (LTER) to address the dynamics of ecosystem change in South Florida due to climate change. The exact amounts of the USACE and the FIU LTER combined contributions to EMMA and the creation of an adaptive foundational resilience protocol are not yet known and will need to be negotiated.

EMMA Cost Estimate

Everglades Mangrove Migration Assessment	\$2,760,000
--	-------------

Directing Coastal Ecosystem Resilience Phase 1: the Mangrove Experimental Manipulation exercise (MEME)

In order for the coastal wetland landscape to adapt to the impacts of increasing salinity and inundation with increasing sea level rise (in the absence of restored freshwater flows), marsh species must maintain productivity levels that enable the rate of positive soil elevation change to increase at a greater rate than SL (e.g., wetland adaptive capacity). In this experiment, the overarching hypothesis that increased phosphorus availability and sediment elevation will confer the greatest adaptive capacity in a marl-forming coastal marsh (the greatest increase in annual and long-term soil elevation rate relative to the rate of sea level rise) will be tested. We further hypothesize that given the same environmental conditions (phosphorus and elevation), sawgrass species will support the same adaptive capacity as low-density red mangrove species. At a higher density of red mangroves, it is postulated that the degree of adaptive capacity will outpace that conferred by sawgrass and low-density red mangrove. To improve coastal wetland ecosystem function degraded by saltwater intrusion, this experiment will help elucidate environmental factors limiting positive wetland soil elevation change and illuminate optimum approaches for enhancing the ecological resilience of coastal Everglades sawgrass and low-productivity mangrove wetlands.

The site is located within an area of the South Florida Water Management District, at approximately 25°17'25.02" N, 80°26'51.10" W, immediately north of the C111 canal and west of US1 (Figure 9-28).

The experimental plots support treatments of phosphorus, sediment elevation, and sawgrass with different red mangrove densities.

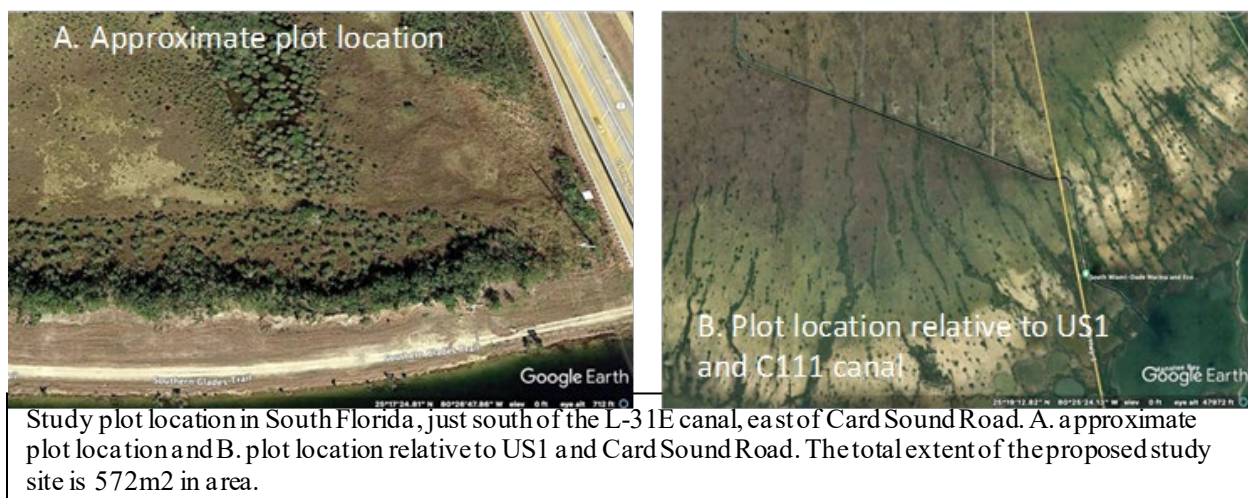
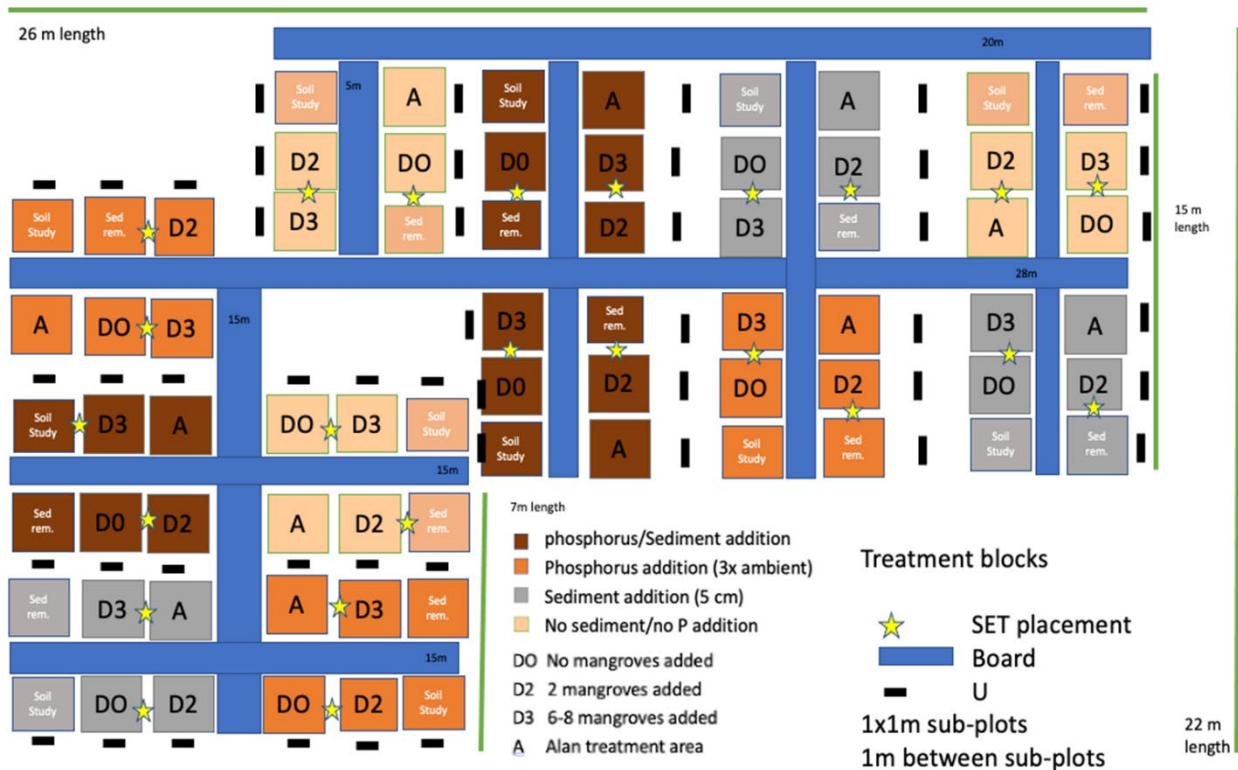

Figure 9-28: Study plot locations.

This pilot study uses small 1-meter test plots to assess a number of approaches that could enhance the flood protection and ecological diversity of the coastal mangroves in the face of sea level rise. The distribution of these plots within a scrub mangrove community along the C-111 canal, just west of FL Highway 1, is shown in Figure 9-29. MEME manipulations are replicated and include three treatments: a planting treatment, a soil addition treatment, and a phosphorus addition treatment. Due to this multi-factorial design, MEME requires some 60 plots.



MEME study design. Legend for the above MEME Study (*NA = No Amendment; S = Shallow (amendment +/-5cm); M=Moderate (+20-25cm); D = Deep (+50cm)

Figure 9-29: MEME and MEME Study Design.

Many of the techniques and analyses identified as part of EMMA are also part of MEME. These include SETs, soil nutrient changes, soil elevation changes, plant growth, and plant recruitment. Primary response variables include soil elevation and surface accretion; porewater salinity, dissolved nutrients, carbon (C) and sulfide; sawgrass and red mangrove aboveground standing biomass (non-destructive technique; belowground biomass and root productivity; periphyton biomass and accumulation; water level and hydroperiod; and soil and plant tissue C, nitrogen and phosphorus. A continuous water level and salinity monitoring gauge will be deployed. Shallow 2.5cm diameter PVC samplers, installed to sample soil porewater at 15 cm below the soil surface, will be installed in each sub-plot. Secondary response variables

include leaf and root decomposition rates. Red mangrove saplings will be planted at 2 saplings per meter squared and 6 per meter squared.

MEME Cost Estimate

Mangrove Experimental Manipulation Exercise	\$375,000
---	-----------

South Miami-Dade Curtain Wall



This resiliency project is mainly tied to the District’s mission to provide flood control, water supply protection, and ecosystem restoration. The South Miami-Dade Curtain Wall Project is being implemented by the District in the southern part of its water management system, adjacent to southwest Miami-Dade County developed areas and Everglades National Park. Curtain Walls are in-ground groundwater and seepage barriers that help to limit water flow in South Florida’s porous aquifer. The South Miami-Dade Curtain Wall Project will increase the District’s ability to manage water levels in Water Conservation Area 3A in Everglades National Park. Benefits associated with these established engineering features include flood protection, water supply maintenance, saltwater intrusion prevention, and ecosystem restoration by improving water

flow to Florida Bay and other estuaries. More specifically, this project will help prevent seepage of water from Everglades National Park while keeping the water in the park to support restoration goals and promote flow south toward Florida Bay instead of seeping eastwards towards developed areas of South Dade where such seepage contributes to a reduction in flood protection level of service.

Extensive hydrologic and hydraulic modeling efforts allowed the District to evaluate the most effective alternatives in terms of the alignment, depth, and extension of these proposed barriers and associated impacts. Feasibility Assessments developed since this project was first conceptualized describe project alternatives in combination with the current and future condition operations of the C&SF water management features and CERP projects in the region. This project has been positively received in many of the public meetings that have been held and are of interest to private, public, local, state, and federal stakeholders in the region.

The Curtain wall project has been advanced in waves starting from planning studies in 2015 and 2018 to demonstrate the effectiveness of the feature as a solution that reduces flood risk while simultaneously

enhancing restoration benefits. The recent modeling effort completed by the District in 2018 demonstrated the benefit of the curtain wall for both restoration and flood control. Several curtain wall configurations were examined. Figure 9-30 illustrates three different scenarios; a 27-mile South a 19-mile scenario, from Structure S-331 to Structure S-177, including a portion of the 8.5 Square Mile Area (Las Palmas Community) in unincorporated Miami-Dade County; a 19-mile North scenario, from Structure S-335 including all of the 8.5 Square Mile area; and a 31-mile Full Extent scenario from Structure S-335 to Structure S-177. The 27-mile South scenario, with gaps in the curtain wall, was recommended for more detailed study and implementation because it provided the best outcome for restoration and flood control while mitigating impacts to Biscayne Bay, Taylor Slough, and water supply.

More detailed work to support the design of the regional curtain wall was initiated in 2020 as part of a detailed public planning process, which was later suspended to allow for the expedited, detailed look for the limited curtain wall adjacent to the 8.5 SMA, and then the continuation of that wall as part of CEPP to connect to the L31N levee. Both these initial reaches are either completed or nearing completion Figure 9-30 illustrates the alignment options along which geotechnical exploration was undertaken as part of the public planning process. The hydrogeologic information gathered from geotechnical borings and geophysical logs was necessary to improve the model representation of the underlying geology of the possible wall alignment and provide important design information. The actual alignment and depth of the wall, as well as the designed gaps to avoid adverse impacts on Taylor Slough, will be determined when the public planning process is re-engaged. The information garnered from the currently implemented sections of the wall and from the additional hydrogeologic data acquisitions will ensure the layout of the remainder of the curtain wall sections addresses stakeholder concerns (including water supply, saltwater intrusion, flows to Biscayne Bay, etc.) and is cognizant of future conditions, including planned projects in the region. The modeling and tools developed for this study will be made available through the Statewide Model Management System for interested parties.

The results of the H&H modeling, illustrated in Figure 9-31, demonstrate the flood control and restoration improvements resulting from the 27-mile South scenario. Wetter conditions were observed in Everglades National Park, and drier conditions were observed in the eastern developed areas and in the South Dade agricultural areas demonstrating improved restoration and flood protection conditions, respectively.

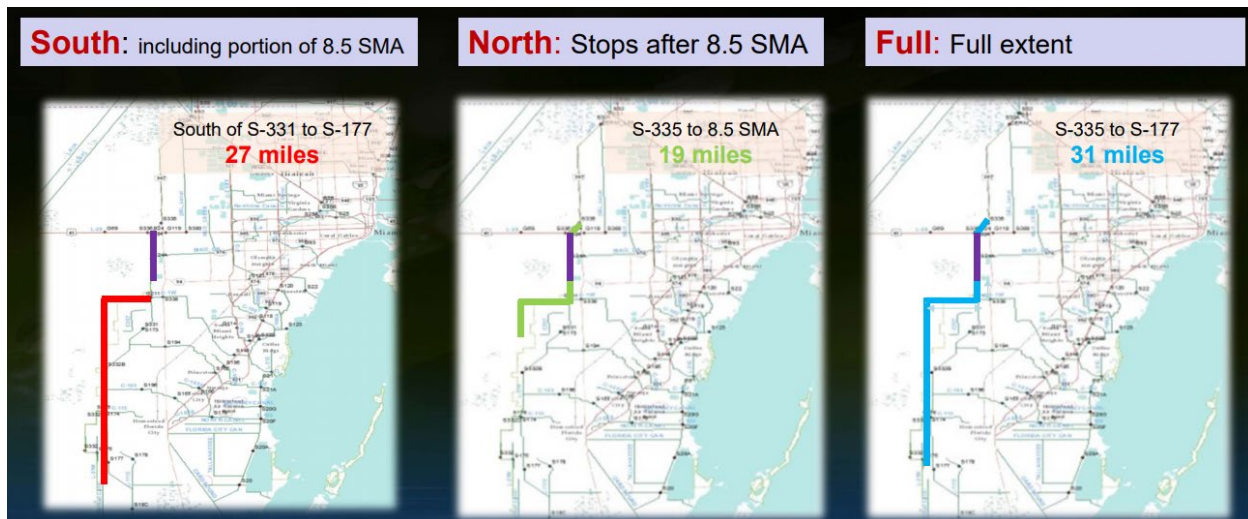

Figure 9-30: Location and extension of three curtain wall configuration scenarios (2018)

Results of all three scenarios also show increased average annual overland flows to Shark River Slough, during wet and dry seasons, compared to the No Wall scenario, as illustrated in Figure 9-31 and Table 9-8 below. Flows to Taylor Slough also improved with the Full and South wall scenarios. Successfully intercepting and redirecting flows back into Everglades National Park reduces the availability of regional water to Biscayne Bay; therefore, ongoing studies and future opportunities to ensure flow to Biscayne Bay are maintained or enhanced are being advanced as part of parallel efforts. The Biscayne Bay Southeastern Everglades Ecosystem Restoration Project (BBSEER) is being advanced in collaboration with the USACE with the goals of making progress towards restoration of depth and duration of freshwater at Biscayne Bay, as well as ecosystem structure and function with improved native plant and animal abundances and diversity. The study recommended additional data collection and more rigorous modeling, which was authorized and funded by the Governing Board in 2020. The project public planning process that engages stakeholders and partner agencies is ongoing.

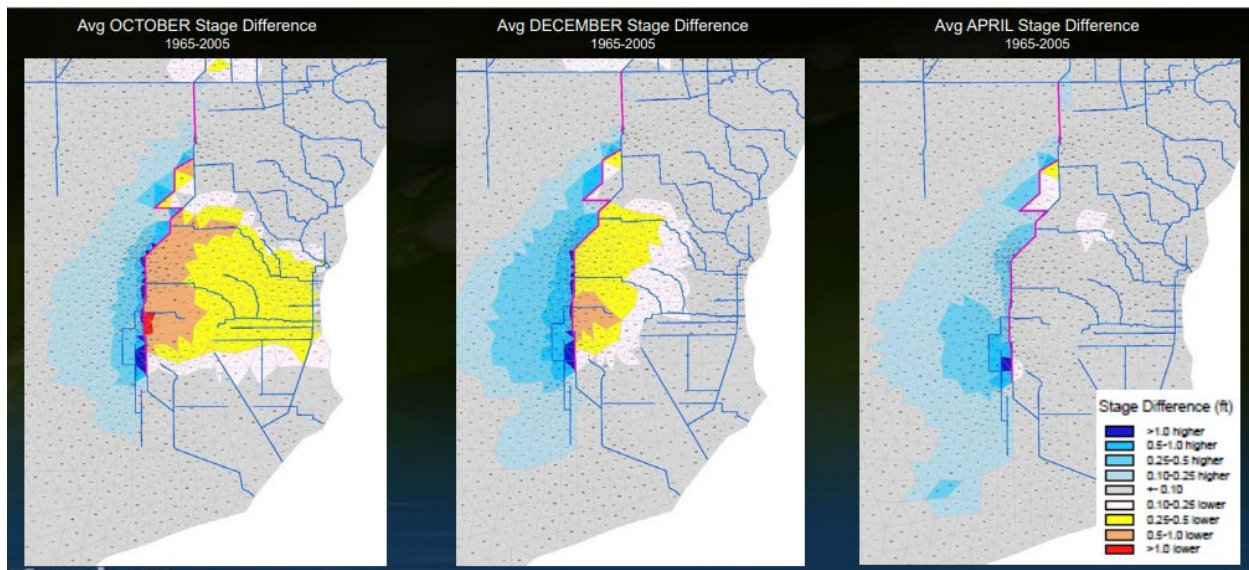

Figure 9-31: H&H modeling results illustrating the average water stage difference with and without the full extent curtain wall scenario.

Table 9-8: Average Annual Overland Flows to Shark River Slough during wet and dry seasons for three curtain wall scenarios compared to the no-wall scenario.

	No Wall	South Wall	North Wall	Full Wall
Shark River Slough	833	890	873	884
Wet Season (Jun-Oct)	466	501	486	491
Dry Season (Nov-May)	367	389	387	393
Taylor Slough	85	109	82	99
Wet Season (Jun-Oct)	61	74	59	69
Dry Season (Nov-May)	24	35	23	30
Biscayne Bay	927	874	897	889
North Bay	561	534	571	570
Central Bay	120	114	121	121
South Bay	246	226	205	198

In March 2021, the SFWMD Governing Board approved the construction of the initial phase of the South Miami-Dade Curtain Wall Project / Seepage Cut-off wall, which consists of a 2.3-mile-long, 26-inch wide curtain wall along the 8.5 Square Mile Area (Las Palmas Community) in unincorporated Miami-Dade County, along the C-358 Canal and the L-357W Levee. The 8.5 Square Mile Area Curtain Wall is nearing completion. The total costs for the initial 2.3 miles - \$15M is fully funded with State Funds in a multiyear project. The project was bid on a per unit length basis to allow the continuation of the wall subject to additional funding.

In August 2002, the SFWMD Governing Board approved the construction of additional 4.9 miles of seepage cut-off wall along the L-357W Levee from the end of the 2.3-mile segment to the junction with the L-31N Levee, as part of the Central Everglades Planning Project (CEPP). This additional project continues to minimize seepage from Everglades National Park (ENP) and mitigate regional flooding in urbanized areas downstream.

The additional new funding will facilitate the construction of incremental curtain wall sections, increasing the ability of water managers to address high water events in Water Conservation Areas and the Central Everglades, promote flows to Florida Bay, and better utilize assets built for achieving restoration goals and providing flood mitigation.

The cost estimates below propose to incrementally build the curtain wall assuming five to ten miles every three to five years at an average cost of \$8M-\$10M per mile escalated for inflation for the out years. The final design of the full wall will be established at the end of the public planning process and may exceed the total miles recommended in the initial study. Additional project refinement and confirmation of the final extension of the seepage wall will be defined based on further model analyses and monitoring efforts.

South Miami-Dade Curtain Wall Cost Estimate

Implementation Timing	Amount*	Incremental Strategy
Immediate Needs (FY22-FY25)	\$75,000,000	Construction of 5-10 Miles
Near Term (FY25-FY28)	\$75,000,000	Construction of 5-10 Miles
Intermediate-Term (FY28-FY31)	\$75,000,000	Construction of 5-10 Miles
Long Term (FY31-FY34)	\$75,000,000	Construction of 5-10 Miles

*Cost in 2020 dollars will be adjusted for future years, assuming 7.5 Miles

Renewable Energy Projects

Solar Canopy at District Headquarters



Among renewable energy projects, the District is proposing the installation of a solar canopy in the District Headquarters parking lot. Fleet vehicles could be parked under the canopy to keep them protected from the elements. The solar canopy would use net-metering to offset a portion of the energy usage and carbon footprint at District Headquarters. Electric vehicle charging stations could also be installed to utilize power generated by the solar canopy.

Floating Solar Panel Pilot Project

A floating solar panel pilot project on Lake Freddy at District Headquarters would help to offset energy costs. Floating solar panels have a lifespan of 25+ years and are designed to withstand hurricane-force wind conditions. Additional benefits include increased energy production due to the cooling effect of water (in some cases 10+%), neutral or positive environmental impact, improved water quality, and reduced algal blooms due to the shading of the water column.



Total Amount of Funding Request	Duration
\$ 885,674	1 year

Solar Panel Installations at C-43 and C-44

In addition, the District is initiating coordination with Florida Power and Light to potentially install solar panel facilities at the C-43 and C-44 Reservoir adjacent lands with the goals of reducing energy costs at these facilities as well as offsetting carbon emissions from existing and new proposed pump stations that rely on non-renewable sources. Different options are under consideration, including both smaller 2–5-megawatt projects to power local energy needs and solar farms up to 75 megawatts to generate power to the grid, using District lands.

Total Amount of Funding Request	Duration
C-43 Solar Panel Installation Costs (2-5MW: \$8,000,000 – 10,000,000)	1 year
C-44 Solar Panel Installation Costs (2-5MW: \$8,000,000 – 10,000,000)	1 year

10: Priority Planning Studies

Summary

Various planning projects and efforts are being prioritized as part of the District's Resiliency Program. These studies are an integral part of providing South Florida with a robust and resilient flood infrastructure, now and in the future. Planning projects help support the South Florida Water Management District's (SFWMD or District) Resiliency mission by coordinating scientific data and research needs to ensure the projects are founded on the best available science.

Hydrometeorological monitoring has played an important role in managing the water control system in South Florida. Through its DBHYDRO tool, the District stores and makes hydrologic, water quality, and hydrogeologic data available to the public and partner agencies. Continuing efforts to enhance monitoring are important to combat a changing climate and increasing sea levels. Science and data are required to build a resilient water management system and infrastructure that addresses current and future impacts. Hydrometeorological data such as seawater level, air temperature, incoming solar radiation, rainfall, and evapotranspiration rate can provide trends that can help with the prediction of climate change. Due to the relatively slow process of climate change, monitoring stations must be of high quality and structurally stable to minimize environmental disturbances to the station. In this context, the District is implementing a set of water and climate resilience metrics to track and document shifts and trends in District-managed water and climate data. These efforts support the assessment of current and future climate condition scenarios and District resiliency investment priorities. As part of the District's communication and public engagement, the effort will provide information to stakeholders, and public and partner agencies, while supporting local resiliency strategies. Key planning projects are detailed below to support the continued monitoring and metrics development.

In addition to observed and projected data analysis and monitoring processes, hydraulic and hydrologic modeling efforts are fundamental in evaluating the effectiveness of the District's flood control assets which include canals, structures, and pump stations. Modeling efforts help to determine if the flood control system meets and will continue to meet flood protection needs. The Flood Protection Level of Service (FPLOS) Program is being implemented at a regional and local scale using a suite of tools and performance indicators for evaluating structures and canals in selected watersheds, as well as a framework for establishing the level of service at each basin. The program incorporates input from meetings and workshops with local planning and stormwater management efforts, stakeholders, and resource managers. The results provide support for local flood vulnerability assessments based on the latest modeling tools and most advanced dynamic H&H models, simulating existing drainage

infrastructure to determine flood inundation scenarios, the necessary integration between surface and groundwater systems, and tidal/storm surge and rainfall scenarios for current and future conditions. Modeling efforts also include future conditions groundwater modeling to evaluate sea level rise (SLR), the saltwater intrusion monitoring network, and climate change impacts that may influence future water use vulnerability.

Recurring funding needs to continue to advance Phase I - Assessments and Phase II Adaptation Studies in priority basins annually, as well as groundwater/water supply modeling efforts, are detailed below.

FPLOS Adaptation and Mitigation Planning (Phase II Studies)

FPLOS Phase II studies will build upon previously developed FPLOS Phase I water management (H&H) models to identify feasible flood adaptation and mitigation solutions in critical basins. The results of these studies will help develop recommendations for regional and local integrated strategies and priority infrastructure investments, and

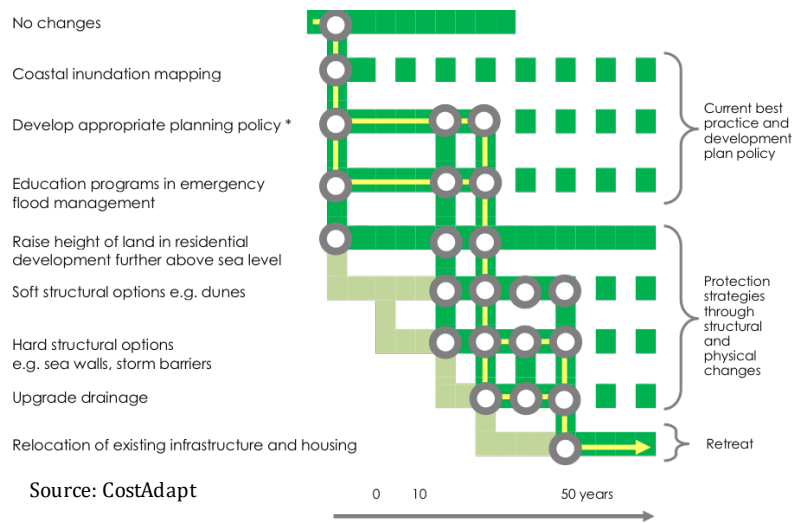

operational changes that may be required to ensure continued long-term performance of the at-risk parts of the system. When the FPLOS assessment (Phase I Studies) identifies a deficiency in the flood control system, a detailed public planning study is initiated to identify appropriate resilient adaptation strategies. This public planning approach ensures the agency, in collaboration with partners and stakeholders, determines the best local and regional solutions that are not limited to the primary system. The comprehensively evaluated and coordinated course of action, based on robust technical assessments, will ensure that the District’s flood protection systems maintain their level of service in response to population growth, land development, SLR, and climate change.

It is crucial that this phase of the FPLOS program be properly funded, preferably with recurring funds, because it identifies projects that are ready to design and build, both for the District and for local stakeholders that are responsible for secondary and tertiary flood control assets. Results from this phase may (on a project-by-project basis) provide recommendations for cost-share opportunities with Federal, state, or local partners. A constant stream of properly, regionally evaluated project features across the

three tiers of the flood control system will position the region well to compete for state and Federal funds for flood control and flood resilience infrastructure.

An adaptation pathway approach is incorporated into the Phase II studies to support the definition of an implementation strategy for the recommended projects (sequences and combinations of flood adaptation and mitigation strategies). If an individual flood mitigation alternative is not able to achieve the specified target of a predetermined performance criterion, additional mitigation strategies are triggered, setting up a plan on how multiple strategies can be implemented over time.

In FY23, Phase II Studies were completed for the C-9 and C-8 Basins in Broward and Miami-Dade counties. The C-7 Pilot Phase II Study is under initiation. The Program's annual budget is \$2M, with at least one new start every year. Design costs are not included as part of this phase and will be completed upon funding confirmation for each individual recommended flood adaptation project.

Total Amount of Funding Request	Duration
\$2,000,000	Yearly - recurring

FPLOS Assessment (Phase I Studies)

FPLOS Phase I Studies have been ongoing for the past eight years. These studies identify and prioritize long-term infrastructure improvement needs in response to population growth, land development, SLR, and climate change. The requested funding will be used to advance the development of water management (H&H) models to evaluate the flood protection system operations under changed current and future conditions. This phase identifies issues in the flood control system in 8- to 10-year cycles through a comprehensive, regional approach to addressing flood risks, intensified by SLR. Phase I

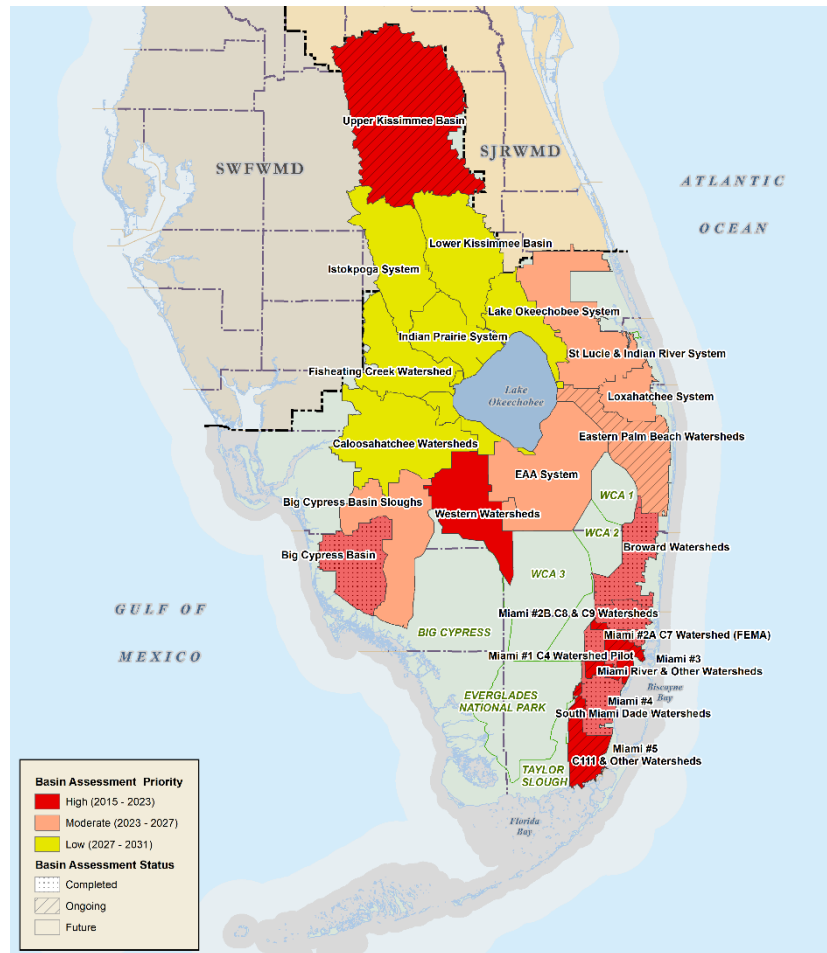

studies also properly characterize flood vulnerability, risks to critical assets, and potential co-benefits of integrated solutions. This effort is integrated into the District’s Capital Improvement Program to ensure its structures, pumps, and canals are functioning as designed and will remain operational under future climate conditions.

This cost estimate detailed below is for full funding, which will allow the FPLOS program to meet its planned schedule of two new assessments each year, to meet the goal of cycling through all District basins every 8 to 10 years. All FPLOS H&H models, input data, and output results developed as part of assessment and adaptation planning efforts are being and will continue to be stored in the [statewide model management system](#).

Total Amount of Funding Request	Duration
\$2,000,000	Yearly - recurring

Water Supply Vulnerability Assessment

The SFWMD is conducting a Water Supply Vulnerability Assessment aimed at understanding how future development and climate conditions impact the regional water supply. As an initial effort, SFWMD is developing the East Coast Surficial Groundwater Model (ECSM) to be density-dependent, allowing for SLR scenarios to be incorporated into the model simulations. Additionally, SFWMD has contracted Florida International University (FIU) and the US Geological Survey (USGS) to develop future conditions rainfall, evapotranspiration (ET), and temperature datasets to support scenario formulation for the ECSM model runs and other regional modeling.

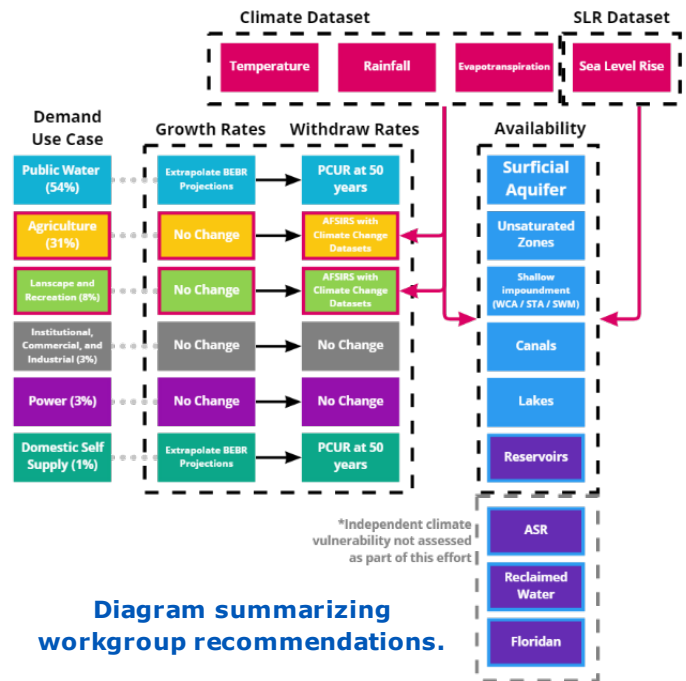

SFWMD created an internal workgroup with representation from various bureaus to develop an approach for identifying and assessing vulnerabilities. Initial scenarios, modeling assumptions, input data selection and limitations, research, scope, time, and cost were considered in the development of the proposed approach. The following illustrations summarize a subset of initial recommendations and assumptions that are integrated into the proposed approach. More detailed information on the approach and next steps are described in the upcoming report: Water Supply Vulnerability Assessment – Scoping (Appendix C).

To properly analyze the effects of climate change, including SLR, each of the water availability sources will be analyzed as independent “buckets,” and model outputs will highlight the effects of select parameters. Initial scenario formulation proposes less and more conservative estimate ranges, with degrees of warming, dryness, and sea level rise, along with growth scenario ranges. The outputs of these scenario runs should allow SFWMD to understand how future conditions may impact source characteristics, water management operations, and overall water availability. Future iterations may include the analysis of water management strategies and their effects.

The vulnerability assessment will be in addition to the 5-year update to the Lower East Coast Water Supply Plan, anticipated to be completed in 2024, and other upcoming water supply plan (WSP) efforts.

The assessment will therefore be based on WSP methodologies by independently analyzing climate effects on growth rates, withdrawal rates, and available water supply sources. Public water supply and domestic self-supply's 20-year growth rates are currently being extrapolated to 50 years through an ongoing contract with the University of Florida's Bureau of Economics and Business Research. Respective withdrawal rates will be calculated using the 20-year per capita use rate. Agriculture, landscape, and recreational withdrawal rates will include projected temperature, rainfall, and ET rates at 50 years. The surficial aquifer and other fresh water sources will incorporate SLR in its boundary conditions, and all surface water and unconfined groundwater will incorporate future temperature, rainfall, and ET conditions. The Water Supply Vulnerability Analysis will be conducted in an open public process with periodic updates and public meetings throughout the process. Notifications will be sent at the appropriate time. The funding request is to support modeling scenarios formulation and development, followed by the analysis and reporting of results.

Total Amount of Funding Request	Duration
\$1,200,000	Four Years – One time

Water and Climate Resiliency Metrics - Web Tool Implementation

As part of a series of resiliency initiatives to address changing conditions, the District has established an initial set of water and climate resilience metrics District-wide. These science-based metrics were developed with the goal of tracking and documenting trends and shifts in water and climate data. The metrics support the assessment of current and future climate condition scenarios and related operational



decisions that inform vulnerability assessments, adaptation planning, and decision-making in support of the determination of District resiliency investment priorities. As part of the District’s communication and public engagement priorities, this effort informs stakeholders, the public, and partner agencies about the District’s resiliency efforts while supporting local resiliency strategies.

The Water and Climate Resiliency Metrics are an important step towards planning for the future with consideration of long-term observed trends and their impacts on the District’s mission. The initial set of selected water and climate resiliency metrics are currently being automated for publication through an interactive web portal, providing navigation to different locations District-wide and access to real-time data. The portal generates alternative mapping, chart, and graph options to display and communicate trend results supported by a story map.

This webtool provides real-time updates of observed data and automated trend analyses for eight of the fifteen prioritized Water and Climate Resiliency Metrics. Real-time automation minimizes rework and reprocessing of trend analysis for the selected metrics based on the best available data and is integrated into the District’s existing database tools, DBHydro. Currently, DBHYDRO Insights automation is completed for tidal elevations, groundwater levels and chlorides, and evapotranspiration. Additional story maps finalized include regional rainfall, salinity in the Everglades, estuarine and mangrove inland migration, and soil subsidence. Water Quality automation and story maps are projected to be completed in FY2023.

This funding request will be used to incorporate new metrics, continue automation and finalize additional story maps. In addition, funding will support continued integration between DBHydro and the ESRI-based Resilience Metrics Hub featuring story maps and web tools for analyzing and sharing data, as well as the development of the Water and Climate Resiliency Metrics Phase II – Development of Future Projections.

Total Amount of Funding Request	Duration
\$300,000	Three Years – One Time

Hydrometeorological Data Monitoring

This funding request for hydrometeorological monitoring will be used for establishing key baseline monitoring stations and evapotranspiration monitoring for Lake Okeechobee and the rainfall monitoring network, focusing on specific resiliency needs. Future additional data needs will continue to be identified and validated through the Water and Climate Resiliency Metrics Project.

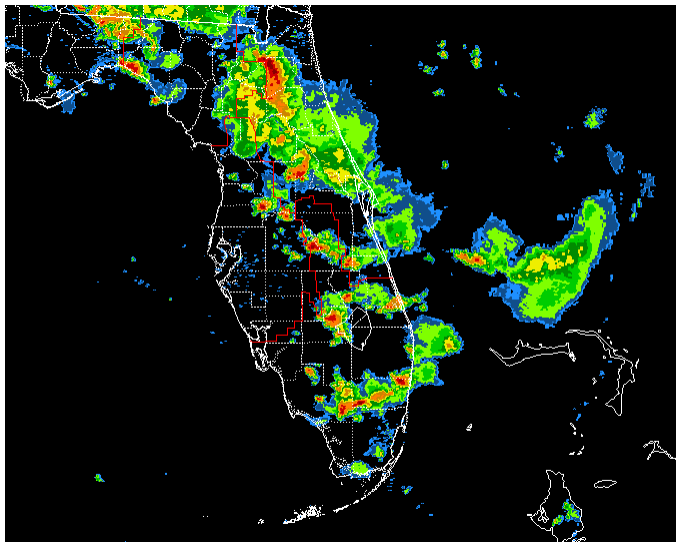

Hydrometeorological monitoring has played an important role in managing water control systems in South Florida. Stage, flow, and rainfall data are used daily in SFWMD’s Operations and Control Center. District weather stations, Florida Agricultural Weather Network stations, and National Oceanic and Atmospheric Administration stations have been used to calibrate/verify the Geostationary Operational Environmental Satellite estimate of incoming solar radiation. Incoming solar radiation is the most important factor that drives evapotranspiration and therefore is vital for the generation of reference evapotranspiration and potential evapotranspiration estimates for all of Florida at the resolution of 2 km by 2 km grids.

With proper support from the Resiliency program, rainfall analyses, such as temporal and spatial distribution and trend analysis, can be strengthened and conducted at more frequent intervals, including sub-daily analyses. Rain gauge stations can be added to the network to address the coverage disparity identified by the Rain Gauge Network Optimization study. A properly distributed rain gauge network will benefit radar rainfall estimates and climate change trend analysis. Additionally, the National Hurricane Center in Miami has been using the meteorological data from the District’s weather stations for hurricane prediction. More accurate data would benefit these efforts as well.

Building resilient water management systems and infrastructure requires science and data. Time series hydrometeorological data such as seawater level, air temperature, incoming solar radiation, rainfall, and evapotranspiration rate can provide input for trend analyses used for the prediction of climate change.

Total Amount of Funding Request	Duration
\$300,000	Four Years – One Time

Statewide Regional Climate Projections

Statewide Regional Climate Projections are being developed by the Florida Flood Hub and in coordination with the Florida Department of Environmental Protection (FDEP), USGS, academia, Water Management Districts, Regional Planning Councils, Florida Department of Transportation, and other partner agencies to capture conditions/mechanisms of rainfall and other related climate variables. Determination of future extreme rainfall conditions (both wet and dry conditions) is key for evaluating potential impacts from climate change to the operation of District infrastructure and mission implementation. The District has a specific interest in the determination of future rainfall scenarios as part of FPLOS Phase I Assessments and the Water Supply Vulnerability Assessment.

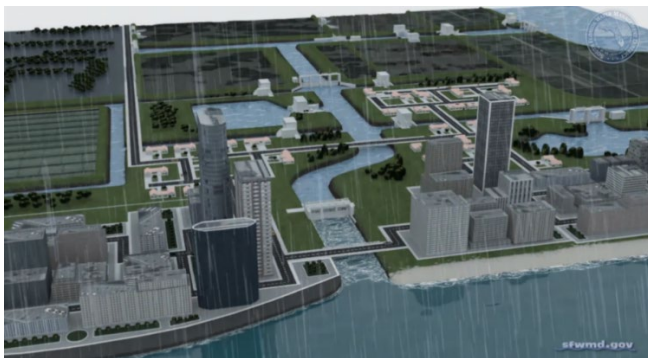

The District, the U.S. Geological Survey, Florida International University (FIU), and local governments have been working over the past six-plus years to evaluate global and regional climate models to estimate future extreme rainfall conditions. In May 2019, the District and FIU organized a Workshop to define a strategy for the development of uniform rainfall

scenarios in Florida. As part of the short-term workshop recommendations, the District, in partnership with USGS and FIU, assessed the best available downscaled climate datasets and published the “Extreme Rainfall Change Factors for Flood Resiliency Planning in South Florida” at the [Water and Climate Metrics Hub](#). The Florida Flood Hub has partnered with the same team to extend these projections statewide, which was recently initiated in FY2023 under the technical supervision of an established working group with representatives from all the partner agencies listed above. A parallel long-term effort is being conducted, as recommended in the 2019 Workshop because the use of available climate datasets for estimating future rainfall in Florida shows biases in extreme rainfall, which are relatively large when comparing past observations with the climate model’s historical data. The Statewide Regional Climate Projections modeling effort will be better suited to capture conditions/mechanisms of rainfall occurrences in South Florida, including contributions from tropical storms and sea breeze, as well as Florida shelf and ocean dynamics and other important climatic processes. Advancing a statewide, regional climate projections model will reduce future rainfall uncertainty estimates in Florida. The financial contribution from SFWMD to this project, in support of the Florida Flood Hub, is summarized below.

Total Amount of Funding Request	Duration
\$150,000	Three Years – One Time

Enhancing Tidal Predictions (SFWMD, University of Miami Rosenstiel School of Marine and Atmospheric Science)

Local near-future tidal predictions are being developed in partnership with the University of Miami (UM) Rosenstiel School of Marine and Atmospheric Science (RSMAS) to capture tidal conditions influenced by global and local variables. Establishing accurate near-future tidal conditions is key for evaluating potential impacts due to SLR on the operation of the District’s coastal structures and mission implementation. Accurate tidal predictions will improve water management response and response timing, ultimately reducing flood disaster risks and benefiting communities in South Florida.

NOAA tidal predictions, which are available for any site well into the future, are limited by current model inputs. These tidal predictions use sea-level information from 1983-2001, a historical period that does not account for the roughly six-inch rise in sea level observed in South Florida in the last 20 years.

Furthermore, these tidal predictions are produced using a course seasonal average of tides and lack inputs representing current weather or oceanic conditions.

In 2022, UM RSMAS completed improvements to current tidal predictions by accounting for more recent changes in sea-level rise and including adjustments for surface pressure forecasts (weather elements such temperature, wind velocity and direction, humidity, rainfall, cloud formation, sunshine, thunder and lightning over a geographic area) to address the limitations of current tidal predictions. Moreover, the improved prediction model includes a multiple linear regression that accounts for various additional relevant parameters, such as oceanic waves. The updated model has been run and validated for NOAA’s Virginia Key Tide Station (and its U.S. global weather model (GFS) output is available for up to 10 days in the future.

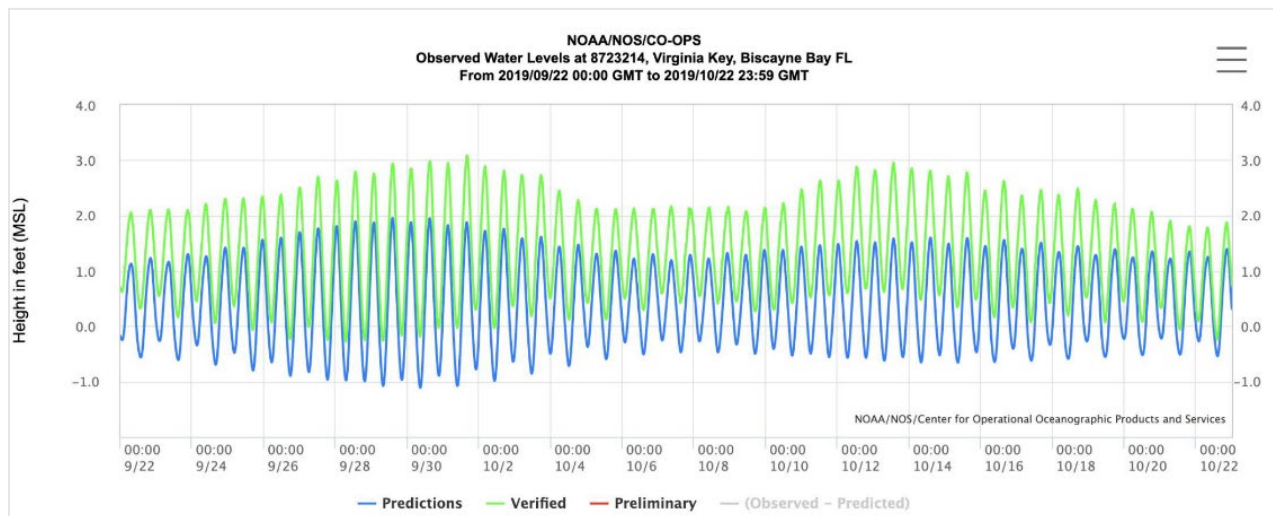

The District is partnering with UM RSMAS to build on current efforts and refine the model for use at additional tide stations along South Florida’s east coast: Port Everglades, Lake Worth, Key West, Vaca Key, and Naples. Near-future tidal predictions based on the latest available data and best available science would provide water managers at the SFWMD and local agencies with more accurate and necessary information to respond to variable weather conditions now and in the future.

Total Amount of Funding Request	Duration
\$ 65,000	2 Years – One time

Flooding Observation Survey and Notification System

Identification and documentation of high-water marks and other flood observations are critical to understanding flood depth and extent and provide observations necessary to validate simulation models attempting to replicate flood occurrence. Identifying where to record and measure high-water marks is a challenge. Flood observations during events can be used to inform high-water mark collection as well as provide an early warning of emerging issues that require investigation to mitigate during an event.

Compilation of flood distribution, depth, and extent over time will inform understanding of trends in flood occurrence and the effectiveness of mitigation efforts. Although there are local initiatives to collect such information, there are no regional or statewide tools that can be leveraged at the local level to assist in early notification or inform high-water mark collection. A regional system of collection and notification would provide local tools to assist local agencies in responding to and documenting flood occurrences within their jurisdiction. It would provide a repository for evaluating flood occurrence over time and could be leveraged to model and develop mitigation measures to address increasing flood occurrence. At a regional level, such tools can be used to assess regional trends and better inform understanding of the response of regional and local systems to rainfall and mitigation measures.

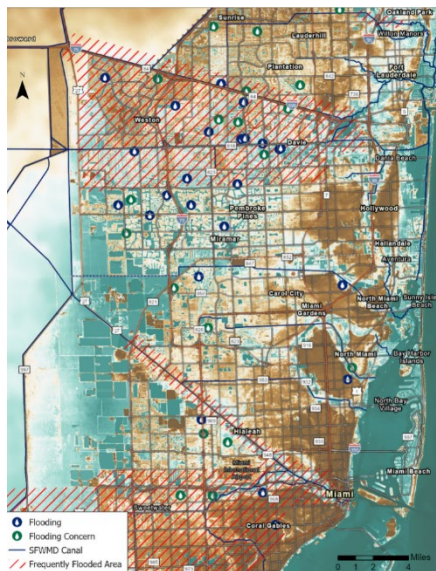

The development of a regional flood observation and reporting system is proposed to standardize and centralize flood observation information. Once established, this repository can serve as the basis for the development of other regional and statewide tools to assist in the compilation and standardization of flood evaluation and be used to validate local and regional modeling tools for design and implementation and mitigation measures.

Although regional monitoring networks provide critical information for the evaluation of hydrologic trends, a repository of ground observations is needed to understand how these trends impact the effectiveness of local and regional stormwater management systems and how mitigation measures are improving those conditions. This proposal is to establish cloud-based regional flood data collection tools and a repository for the standardization of flood observation and high-water mark data to evaluate flood occurrence over time and mitigation measure effectiveness.

Total Amount of Funding Request	Duration
\$1,000,000	Four Years – One Time

Evaluating the Performance of the SFINCS Hazard Model to Support and Accelerate the FPLOS and SEFL Regional Adaptation Planning Efforts

Following the recently finalized collaborative development of the South Florida Water Management District Flood Impact Assessment Tool (SFWMD-FIAT) tool and partnership meetings between the District, Miami-Dade County, Broward County, and Deltares, this project description summarizes regional modeling challenges and proposes an evaluation of a new tool to address these challenges. The FPLOS and regional adaptation planning efforts experience various modeling challenges: First, integration of coastal and inland flood modeling is currently lacking. As a result, the studies do not consider compound flooding. Second, the comprehensive MIKE flood models used by the District and Broward County yield reliable and high-resolution results, but this comes at an expense: run times for individual scenarios amount to nine hours. As a result, detailed probabilistic flood hazard modeling is not feasible. As an alternative, the District and Broward County work with a representative set of scenarios/conditions using a deterministic approach. As an additional consequence, the studies can model only a relatively small subset of the many identified scenarios, introducing decision-making uncertainties. Finally, only model experts can use the modeling tools, and the tools miss an adequate translation to support planning. Herein, Miami-Dade County relies on the modeling work of the District to inform and support its planning efforts.

The USGS and Deltares recently improved and applied the Coastal Storm Modeling System, COSMOS, to the southeast Atlantic coast, including South Florida, as part of their coop. The improvement included setting up and validating the compound flood model SFINCS (Super-Fast Inundation of Coastal Systems), a physics-based, reduced complexity model with typical runtimes of seconds to a couple of minutes for individual hydrometeorological events depending on the spatial scales. The SFINCS flood hazard model is also part of the Community Flood Resilience Support System (CFRSS), recently developed by Deltares in partnership with the Department of Homeland Security. The CFRSS helps address all the above-listed challenges and supports the DHS in its mission to accelerate climate adaptation nationwide. The system application to Charleston, the pilot community, is promising.

The SFINCS and the CFRSS tool could, for example, support the FPLOS program as quick scan tools to evaluate all scenarios of interest quantitatively. Then, based on the results, scenarios for detailed assessments using the comprehensive Mike models can be selected and implemented, reducing uncertainty in decision-making. However, this use requires an additional performance evaluation of the SFINCS model. For instance, validation of the available SFINCS model in the COSMOS modeling system for South Florida focused on the near-shore water levels. Therefore, the proposal is to thoroughly

assess the performance of SFINCS in simulating regional flood extents and water depths by comparing the model inputs, outputs, and computational times with the MIKE models and readily available field observations used to calibrate and verify the MIKE models. The costs for this in-depth performance evaluation are approximately \$75,000 and include updating the SFINCS model application as needed and possible within the scope and available budget. The latter will be determined in collaboration with the District. In FY2023, a workgroup was established with representatives from SFWMD, Deltares, USGS, FIU, the University of Miami, and the University of California Irvine to support the development of this project and additional parallel efforts currently in development for the support of flood adaptation planning.

Total Amount of Funding Request	Duration
\$75,000	1 Year

Green Infrastructure Flood Mitigation Strategies - Associating Water Quality Benefits in the Little River Watershed

In partnership with Miami-Dade County and Florida International University, this project proposed the integration of scientific research and coastal water management challenges to develop actionable information for the resilience of coastal environments in the face of climate change, SLR, and land-use development. The overall goal is to identify nature-based features that can be evaluated for flood protection and water quality benefits in consultation with stakeholders to improve watershed restoration planning.



To enhance regional adaptive capacity for addressing the increasing challenges of flood and water quality protection, a more comprehensive approach to watershed management is needed. This project proposes to address the overarching question: What are the flood mitigation and water quality benefits of cumulative “green elements” of the Community Rating System (CRS) program and other

nature-based features with and without gray flood mitigation approaches? By planning for restoration and enhancement of natural functions that can improve flood protection and water quality benefits within the watershed in a coordinated effort across agencies, supported by the expertise of local academic and NGO collaborators, it facilitates enhancing socio-ecological resilience in the face of SLR and land-use change.

Quantifying flood mitigation and water quality benefits through comprehensive watershed restoration planning is a key outcome of the project. Comparing FPLOS performance metrics, water quality benefits (specifically, TP, TN, and TSS load reductions), and averted economic damage across the diverse set of watershed restoration scenarios will support flood protection planning with quantifiable environmental, societal, and economic benefits assessed by this project. It is expected that future funding opportunities will result in the construction of immediately feasible CRS/Low Impact Development features and zoning/code changes to enable more transformational CRS/Low Impact Development features to be constructed across the C-7 and other basins in South Florida.

Total Amount of Funding Request	Duration
\$450,000	Three Years – One Time

Waterways Impact Protection Effort (Project WIPE-Out)

The project is to assist the District in finding and piloting innovative technologies that can protect the health of water systems upstream and downstream of District conveyance structures. Currently, waterways and canals act as a channel that collects and moves contamination that flows in from basins. This contamination ranges from dissolved nutrients to large debris and eventually makes its way into water bodies, such as Biscayne Bay and the ocean and their natural inhabitants. These water bodies are an essential part of South

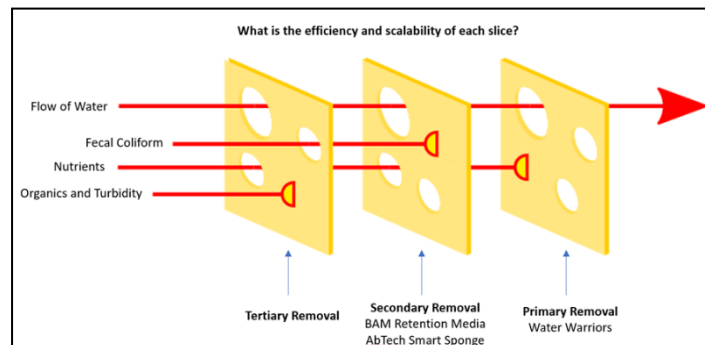

Florida and the global ecosystem. Protecting the health of these unique and fragile ecosystems will require testing different strategies and configurations until a suite of solutions is identified to be scaled across the region as the District advances the implementation of priority resiliency projects.

The WIPE-Out project is part of an overall protection strategy that utilizes a “Swiss cheese” model of hazard and risk management. This model is used across industries from aviation to healthcare and follows the principle of layered defenses, where each layer can block risks, ultimately preventing hazards from taking place. To manage nutrient loads and eutrophication, the proposed multi-layered approach takes the form of multiple locations and technologies of nutrient removal with the goal of eventually scaling appropriate solutions until contaminants are contained within the ideal limits. Future iterations may look at the reductive effects of incorporating nature-based solutions.

Project WIPE-Out will be implemented in partnership with Miami-Dade County and target nutrient removal via two strategies: The WIPE-Out Tech Test and the WIPE-Out Incubator. SFWMD and Miami-Dade County received funding for this project in FY23 through FDEP Innovative Tech Grant. The WIPE-Out Tech Test will identify a selection of promising technologies with scaling potential to pilot in The Little River (C-7 Canal), a culturally and ecologically important canal that has been called ground zero for the challenge of removing



Trash build-up in the C-7 Canal.

contaminates. Every year the District removes more than 200 tons of trash from the Little River, which costs the District over \$100,000. The WIPE-Out Incubator will be a multi-year effort that is focused on creating local capacity through developing nutrient removal ideas

in partnerships with various agencies, universities, and business partners. The incubator will assist in launching new startups and potentially scalable treatment technologies by providing them with a real-world location to test their technology, free monitoring, venture-building courses and programming, and access to non-dilutive seed capital, potential investors, and clients.

Total Amount of Funding Request	Duration
\$3M to \$4M	1.5 - 3 years -One Time

Future Conditions District Internal resources for Regulation

The District’s Regulation Division is proposing the development of an internal tool that will give staff quick access to critical information and resources relevant to both Environmental Resource Permitting analyses and Water Use Permitting analyses as a first step in the District’s initiatives for enhancing regulation standards to account for future climate conditions and for building resiliency into projects. Criteria currently used by the Regulation Division for evaluating permits, such as rainfall and groundwater levels, are subject to change because of non-stationary future climate projections and trends that have already been observed. This information is being incorporated into the Water and Climate Resilience Metrics Hub (Resiliency Metrics Hub (arcgis.com)) to group key parameters that will serve this purpose.

Total Amount of Funding Request	Duration
\$ 150,000	3 Years – One time

Carbon Storage Monitoring and Reporting

To establish routine reporting on carbon uptake and storage totals associated with ecosystem restoration efforts, it is necessary to collect appropriate data for individual restoration projects. This will enable a better representation of their associated mitigation benefits and estimation of resilience benefits. The following data are needed:

- Soil carbon characteristics: To capture short-term and long-term carbon storage, soil bulk density and carbon concentration should be measured at multiple depth increments.
- Soil accretion: To capture soil surface changes and vertical accretion, surface elevation tables, and feldspar marker horizons should be used to monitor soil building and erosion.
- CO₂ and CH₄ gas dynamics: To capture the direction (into the ecosystem or out to the atmosphere) of gas movement and determine the net uptake of carbon at the landscape scale, eddy flux towers should be used to measure the uptake and release of carbon gasses (carbon dioxide and methane).

The District is actively investigating the potential for using satellite, radar, and lidar imagery to capture changes in plant biomass and land cover, as well as to detect changes in land subsidence and topography at the regional scale. Satellite and radar imagery can help the District to effectively track changes in vegetation over time, differentiate between various land cover types, estimate the amount of green biomass present in an area, and determine the potential for carbon uptake. These technologies would also support the detection of changes in land elevation over time and aid in the mapping of topography in both urban and managed natural areas across the region.

In the context of carbon monitoring, exploring the latest scientific publications on the use of satellite and radar imagery can provide a complementary approach to enhance the District's current planning projects for carbon monitoring. Bringing these additional data and analyses would further improve the accuracy and efficiency of carbon monitoring. SFWMD is currently analyzing several relevant scientific publications listed below to explore the full potential of these technologies.

- [NASA Satellites Help Quantify Forests' Impacts on Global Carbon Budget – Climate Change: Vital Signs of the Planet](#): Developing an approach that integrates satellite, laser, and field data can enhance the accuracy of global forest vegetation and carbon stock estimates, thereby facilitating a better understanding of carbon removal rates in forest landscapes moving forward.
- [The Vegetation of Everglades National Park: Final Report \(Spatial Data\) - data.doi.gov](#): An accurate and comprehensive vegetation map of Everglades National Park created using color-infrared aerial imagery from 2009, providing a valuable baseline to measure the effectiveness of

restoration efforts associated with the Comprehensive Everglades Restoration Plan (CERP). The geospatial dataset generated from this imagery will enable the monitoring of changes in vegetation and help gauge the response to hydrologic modifications resulting from the implementation of the CERP.

- [A Remote Sensing Technique to Upscale Methane Emission Flux in a Subtropical Peatland - Zhang - 2020 - Journal of Geophysical Research: Biogeosciences - Wiley Online Library](#): Developed a remote sensing approach to model CH₄ emission flux in the subtropical Everglades wetland by upscaling using Landsat data and in situ model inputs to account for hydrological seasonality.
- [Quantifying net loss of global mangrove carbon stocks from 20 years of land cover change | Nature Communications](#): Used Synthetic Aperture Radar (SAR) global mosaic datasets to estimate the net changes in the global mangrove carbon stock resulting from land cover change between 1996 and 2016 to quantify proportional changes in carbon stock during processes of mangrove loss and gain due to deforestation and forestation.
- [Global hotspots of salt marsh change and carbon emissions | Nature](#): Conducted a global analysis using Landsat imagery from 2000 to 2019 to quantify salt marsh ecosystem loss, gain, and recovery due to landward migration and extreme weather disturbances and estimated the impact of those changes on blue carbon stocks.

By employing these measurements across District restoration projects, accurate assessments of carbon capture and storage associated with different SFWMD and partner agencies' ecosystem restoration efforts can be made. These efforts can be leveraged to demonstrate carbon uptake potential and provide better estimates of their contribution to climate resiliency.

The objective of this proposed project is to establish ongoing monitoring and reporting mechanism for highlighting the benefits of the District's restoration efforts associated with carbon uptake potential. The project costs listed below do not account for expenses related to acquiring satellite, radar, or lidar data, as well as the necessary ground data monitoring required to verify the accuracy of remotely sensed data. The expenses associated with these supplementary efforts will be included in the budget at a later stage after an approach for expanding the project to include the additional work is selected.

Total Amount of Funding Request	Duration
\$1,250,000 - \$2,330,000	3 Years – One time

Designing Wetland Habitat Enhancement and Flooding Improvements for Charlotte Harbor Flatwoods Project

This resiliency planning project links to the District's mission to provide flood control and ecological restoration. The Designing Wetland Habitat Enhancement and Flooding Improvements for Charlotte Harbor Flatwoods project is a Florida Fish and Wildlife Conservation Commission proposal supported by the District coordinated Charlotte Harbor Flatwoods Initiative (CHFI) and part of the South Florida Water Management District's (District) priority projects included in this Resiliency Plan. The CHFI is a multi-agency and community partnership which has been planning and implementing projects for the hydrological restoration of 85,000 acres in the Charlotte Harbor Flatwoods region since 2010. Partners include FDEP, Southwest, and South Florida Water Management Districts, Florida Fish and Wildlife Conservation Commission (FWC), U.S. Fish and Wildlife Service, Florida Department of Transportation, Lee and Charlotte counties, City of Cape Coral, Coastal and Heartland National Estuary Partnership, and other community stakeholders. More on the CHFI is available at <https://chnep.wateratlas.usf.edu/charlotte-harbor-flatwoods-initiative/>.

Benefits:

- • Reduced erosion and regional flooding,
- • Minimized saltwater intrusion by rehydrating the land to increase groundwater recharge.
- • Increased wetland water storage, depths, and duration for habitat enhancement.
- • Improved flows to Charlotte Harbor's tidal creeks, mangroves, and seagrass beds.
- • Decreased nutrient runoff pulses to estuary, reducing harmful algal blooms and protecting fisheries.

The project area includes Yucca Pens Wildlife Management Area (WMA), part of the largest remaining hydric pine flatwoods in southwest Florida, and its tidal creeks that flow into Charlotte Harbor. The WMA's coastal wetlands are within northern Lee and southern Charlotte Counties. The proposed project will deliver the final design and permitting for a large-scale restoration that will improve the hydrology of > 8,000 acres of wetlands, increasing the coastal resiliency of Cape Coral and substantially improving habitat for protected species. The design will build upon a preliminary conceptual model prioritized by Florida's Deepwater Horizon Program and funded in 2019 through Natural Resource Damage Assessment. that simulates appropriate timing and quantity of water flows required to improve wetland

habitat conditions, minimize erosion and offsite flooding, improve groundwater recharge, and reduce the risk of wildfires. Additional modeling using future land use data, predicted population increase, climate change impacts, and SLR, as well as confirmed and potential future land acquisition and restoration projects, was finalized in Sep. 2022.

Specifically, ditch blocks in smaller ditches would increase storage and surface water hydrology. The re-establishment of connections to several tidal creeks to the west of Yucca Pens would be accomplished with low water fords installed through existing off-highway vehicle ruts and ditches in Yucca Pens. This will restore flows from Yucca Pens to Charlotte Harbor at several locations rather than as a point source from the City of Cape Coral’s man-made Gator Slough Canal. An approximately 4.5-mile-long groundwater seepage barrier at the southern boundary of Yucca Pens along Gator Slough Canal will reduce wet season surface water drawdowns and raise groundwater levels in Yucca Pens. All would protect aquifer recharge and reduce the potential for saltwater intrusion with SLR.



The total project costs are around \$650,000, and a full proposal has been submitted to the Coastal & Heartland National Estuary Partnership in December 2022 and may include matching funds from FDEP and FWC. The project duration is 3 years.

Total Amount of Funding Request	Duration
\$650,000	3 Year

Upper Kissimmee Basin Flood Study, Adaptation Planning, and Project Recommendations

This resiliency planning project links to the District's mission to provide flood control. This is a long-identified need to address flood risk reduction in the Upper Kissimmee Basin and mitigate the effects of flooding under conditions that are like what was experienced during Hurricane Ian in the region. First submitted for consideration in 2015 under the name Central and Southern Florida Hydrologic Model Updates and Infrastructure Improvement, this multiphase project is currently ranked #12 in the most recent Osceola County Local Mitigation Strategy project list. Led by SFWMD, this project would involve and benefit Osceola County, the City of Kissimmee, the City of St Cloud, Deseret Ranches, Sunbridge, SFWMD, and St. Johns River Water Management District. The project will be implemented in 3 phases which can be immediately expedited.

Phase 1 of this project includes updating the current SFWMD integrated watershed model for the CS&F system to address unaccounted-for drainage flows from outside the SFWMD boundaries. Phase 2 includes a level of service impact analysis of adaptation and mitigation measures, including operational changes and nature-based and structural infrastructure modifications on flood risk. This phase will recommend, for implementation, a suite of cost-effective and practical adaptation projects. Phase 3 consists of the necessary permitting, design, and construction activities to implement the recommended projects.

The FPLOS Phase I study currently ongoing in the Upper Kissimmee Basin (UKB), SFWMD will complete a model update and an assessment of the flood control system, initiate and complete preparation of the tools for evaluation of potential adaptation strategies, using integrated hydrologic and hydraulic modeling and accounting for projections in future growth/land development in the region and climate patterns. The first Phase is a modeling update to allow a robust assessment of the vulnerability of the system to flooding. The model will also help verify and confirm benefits and fine-tune the operation of identified no-regret strategy projects proposed for immediate implementation.

Working with local government and partner agencies, initiate the UKB FPLOS Phase II study to explore systemwide adaptation and mitigation strategies. Identify components of the regional adaptation that can be fast-tracked for implementation immediately while the project continues to determine longer-term strategies and projects to ensure an adequate level of service within the region consistent with the Central and Southern Florida (C&SF) Flood Control project.

As soon as they are determined, initiate design, permitting, and agency coordination activities to implement the early identified projects.

Following the conclusion and approval of Phase 2, Mitigation and Adaptation Planning Study, initiate design, permitting, and agency coordination activities to implement the long-term flood protection strategy for the Upper Kissimmee region. These may include non-SFWMD projects to be funded and executed by local government and other partners.

Phase 3 consists of Environmental Impact Studies and Federal approval permitting and implementation of structural and operational modifications.

Upper Kissimmee Basin Flood Study Cost Estimate

Total Amount of Funding Request	Duration
\$3,000,000	

A Surface Elevation Table Network To Monitor Accretion and Address Impacts from Climate Change

Introduction

Between the 1780s and 1980s, Florida lost 9.3 million acres of wetlands (Caffey and Schenayder 2003). Wetlands are critical components of Florida’s landscape due to the many ecological services they provide. For instance, mangrove and marsh systems sequester nutrients and sediment in water runoff, produce and store carbon in above-and below-ground biomass, fuel various food webs, serve as nurseries for many fishery species, and constitute habitat for migratory birds, diamondback terrapins, bald eagles, dolphins, manatees, and many other species (Mitch and Gosselink 2000). Current models suggest that another 20% of coastal wetlands may be lost due to climate change (Webb et al. 2013) through the direct effects of rising sea levels and increases in flooding depths, hydroperiods, and storm intensity. Over the long term, rising seas threaten to erode or sink large parts of Florida’s coastal zone (Church et al. 2001, Sklar et al. 2021). However, the many projects associated with Everglades restoration (i.e., CERP) have the ability to increase freshwater, brackish, and saline wetland resilience by enhancing wetland accretion and carbon capture.

In the Everglades, mangroves and marshes have the capacity to maintain elevation via vertical accretion primarily driven by belowground biogenic processes such as root production and decomposition. In some other areas, elevation change may be dependent on inputs of sediment from rivers and storms (Cahoon 2006). However, in Florida, there is insufficient data to indicate where wetlands have the capacity to maintain elevation and how much mangroves and marshes have the capacity to store carbon. Therefore, to better understand the hydrological drivers of carbon capture and to better predict the effects of SLR as part of a general resiliency program, long-term soil elevation change, and accretion rates are needed.

This accretion monitoring program, like the one built into MEME (see Figure 5-1), will study the processes that affect wetland accretion, determine, and compare the rates at which they accrete, compare rates of accretion in differing habitat types and geographical locations, and increase the knowledge of such functions to a level needed to formulate an accurate representation, via multivariant statistical or deterministic models, of the physical and biotic processes involved in elevation change. This, in turn, will permit the District to identify the drivers (i.e., salinity, flow, structure operations, storms, nutrients, etc.) that dominate elevation change, carbon capture, and resilience.

Formulation

This monitoring program constitutes a critical piece of a broader, long-term effort by various state and federal agencies and universities to enhance wetland resilience, sequester carbon, address the potential

effect of climate change, and restore the Everglades. The strategy is to integrate the District, USGS, and FIU surface elevation tables (SETs) into this larger effort and insert new SET sites where most appropriate. To accomplish this objective, the four-phased approach described below is recommended.

1. First phase is to identify and map all known SET locations in the Greater Everglades, including Big Cypress and the Stormwater Treatment Areas and identify geographical gaps in monitoring coverage.
2. The second phase is to install SETs where coverage is poor or absent. These sites will include regions that appear to maintain high accretion rates and sites that can be used as general indicators of large landscapes.
3. The third phase is to monitor the SETs and measure changes in elevation, vegetation structure, and soil composition in relation to changes in sea level, hydroperiods, nutrient inputs, and water management.
4. The fourth phase is to analyze cause-and-effect interactions via multivariate and/or mechanistic models to determine where physical processes dominate elevation change and where biotic processes predominate,

Goal and Objectives

The goal of this monitoring is to determine how water management, restoration, climate change, and SLR will impact accretion, carbon sequestration, and wetland resilience.

Objectives:

1. Compare rates of elevation change and accretion between inland marsh, STA's, coastal marsh, and mangrove habitats
2. Compare rates of elevation change and accretion with local rates of SLR, salinity, hydroperiods, depths, flow, and landscape characteristics.
3. Determine primary drivers of the biotic and physical processes that are linked to accretion and elevation change.

Project Design and Methodologies

An array of SETs and marker horizons (MH) will be installed and monitored in wetland habitats across the Greater Everglades. The network of SET-MH will allow researchers the opportunity to study the impacts of water management, restoration, climate change, and SLR on a large regional scale. This program will integrate into one database that is already funded and installed by the District, the FCE-LTER program at FIU, Everglades National Park, USGS, and NOAA. Data for the entire network,

District, and Federally funded sites will be combined and analyzed by structural, multivariant, or mechanistic equation modeling.

Hypotheses:

1. Rates of elevation change will differ between marsh and mangrove habitats; and with differing soil types (for example, mainly organic vs primarily sand/silt, etc.).
2. The biotic and physical processes of elevation change will produce differing rates of accretion and will differ with anthropogenic inputs such as water management and nutrients.
3. Rates of elevation change and accretion can be enhanced to improve carbon storage, accretion, and climate change resilience.

Surface Elevation Table technology, coupled with marker horizons of inert material such as feldspar, has been used effectively in numerous wetlands to measure the rates of elevation gain and loss over a fine scale (Cahoon et al. 2002 a,b). In Rookery Bay, southwestern Florida, SLR is approximately 2-4 mm/yr (Cahoon and Lynch 1997). Elevations there, measured by SET, have largely kept pace with SLR, although the mangrove fringe forest dominated by *Rhizophora mangle* has lagged behind the *Avicennia germinans* dominated basin forest (Boumans et al. 2002). One study at Shark River, Everglades National Park, found that despite Hurricane Wilma depositing 3.7 cm of new sediment, 10 mm of elevation was lost a year after the storm (Whelan et al. 2009). Over longer periods of time, the increasing CO₂ concentrations associated with climate change may stimulate plant growth and partially offset losses caused by changes in hydroperiod (Cherry et al. 2009).

Due to Florida's variable soil types, tidal ranges, and dominant vegetation, understanding long-term changes in wetland soil elevation change requires study over many sites and years. Further, the ability of wetlands to keep pace with SLR that are currently transitioning from marsh to mangrove at the temperate/subtropical boundary is entirely unknown. To address these data gaps, a more regional scale approach is needed.

The Rod-SET is now the preferred deep SET and will be used here. SET installation and construction details are given by (Cahoon et al. 2002a,b, <http://www.pwrc.usgs.gov/set/>). Both deep (>2 m) and shallow RSETs (collectively termed SET hereafter) will be installed at each site to allow investigation of physical as well as biological (root zone) processes. SET installation and use are illustrated in Fig. 1 from D. Cahoon's USGS website listed above.

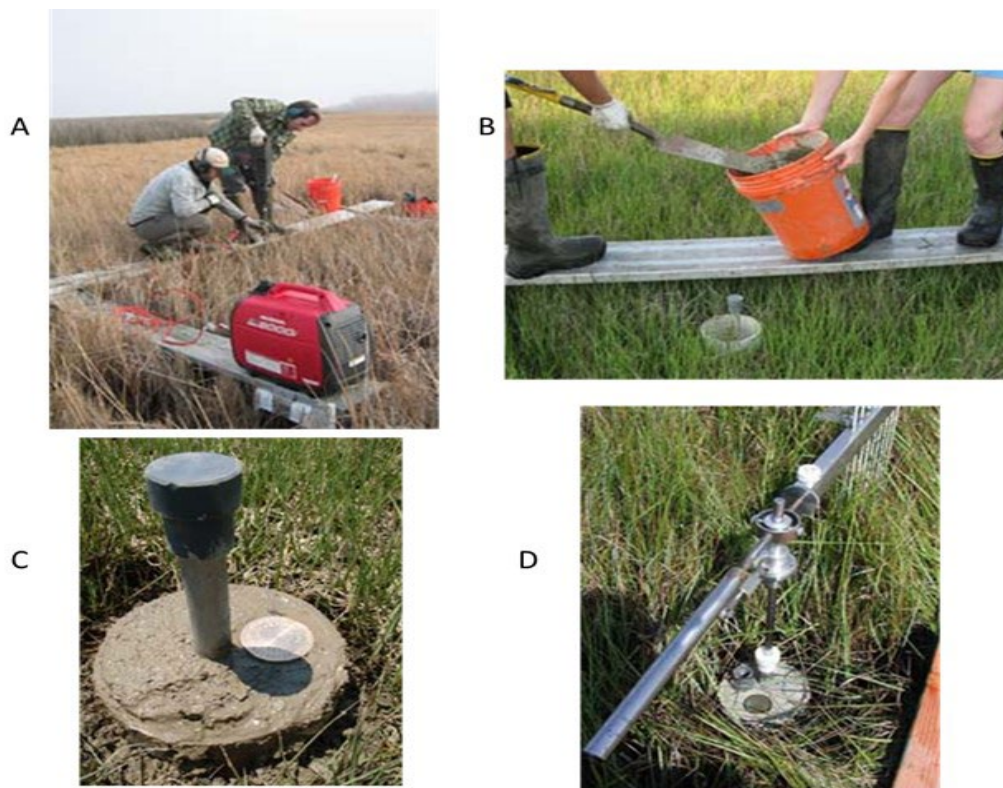

A. Driving rods after constructing the platform. B. Cementing collar and receiver. C. View of a completed receiver with a brass marker. D. SET arm attached to receiver for first readings. Pictures from: <http://www.pwrc.usgs.gov/set/>

Figure 10-1: SET Installation.

Expected Results, Applications, and Benefits

The sites proposed for SET installation in this program will improve the understanding of wetland soil accretion and erosion throughout the greater Everglades. These new SETs will be designed and installed in a way that will tie into the already existing, but currently not centrally coordinated, SET sites in the state. Ultimately, this system will tie into a large national network such as the NOAA Sentinel Site program. Currently, there is a coordinated effort establishing a SET monitoring network in the Gulf of Mexico, Texas through the Panhandle of Florida, and Mid-Atlantic states, Virginia to Georgia. The establishment of the Florida monitoring network could then be added to the existing Gulf Coast and Mid-Atlantic networks to provide a standardized monitoring network from Virginia to Texas.

Flux Towers

The Flux tower monitoring plan described below was developed in partnership with the Everglades Foundation and Florida International University. Flux towers are micrometeorological towers that use eddy covariance methods to determine the exchange rates of carbon dioxide, methane, water vapor, and

energy between the biosphere and the atmosphere. Sensors are placed on the tower above the surrounding vegetation in the mixing zone for wind current eddies between the vegetation and atmosphere. The sensors allow the tower to capture the full profile of atmospheric conditions from the top of the vegetation canopy to the ground. Data collected by these sensors can be used to measure carbon storage (or emission) rates of a particular ecosystem.

Although wetland ecosystems are important globally for their capacity to sequester and store carbon (C) (Aselmann and Crutzen, 1989; Whiting and Chanton, 1993), many wetlands are at risk due to anthropogenic pressure, shifts in climate, and SLR (Spencer et al., 2016). In one of the most dynamic wetland complexes in the world, the Florida Everglades, changes in freshwater supply and accelerated rates of SLR are stressing ecosystems. Particularly striking shifts in ecosystem structure and function occurring on the Everglades landscape include peat collapse (Chambers et al., 2014), the establishment of non-native species (Doren et al., 2009), inland encroachment of coastal woody species (Davis and Ogden, 1994), and the expansion of a low productivity zone along the coast called the “white zone” (Ross et al., 2000). The severity of these changes is further exacerbated by anthropogenic impacts on the quantity, quality, and timing of freshwater discharge and shifts in disturbance regimes.

The subtropical Everglades landscape was created by strong spatial and temporal gradients of water flow that formed a unique network of upland freshwater and coastal wetland ecosystems. The hydrology and disturbance regime in the Everglades region developed a rich diversity of communities that have variable capacities to capture and sequester carbon. Like other coastal wetland ecosystems, primary productivity, respiration, and other processes in the carbon cycle change in response to climate, inundation regime, and salinity.

In the greater Everglades region, the use of the eddy covariance method to measure fluxes of CO₂, CH₄, H₂O, and energy is recommended. Long-term eddy covariance studies by scientists at FIU include 15 years of CO₂ and 8 years of CH₄ data in a marl prairie (TS/Ph-1) and freshwater marsh (SRS-2), 6 years of data from a mangrove scrub (TS/Ph-7), and 18 years of CO₂ and 5 years of CH₄ from the tall riverine mangrove forests (SRS-6). The network includes two recently established research sites in the estuary (Bob Allen; 2 years of CO₂) and at the ecotone between freshwater marl prairies and the mangrove scrub (SE-1; 3 years of CO₂ and CH₄). Towers operated by the USGS were recently incorporated into the greater Everglades micronet and include a pine upland (PU), cypress swamp (CS), and dwarf cypress (DC) to create a transect that extends from upland ecosystems to coastal wetlands and the ocean.

Everglades flux towers are currently managed by independent groups of investigators that contribute data to the FCE-LTER and Ameriflux. While funding streams are currently independent, investigators

collaborate to coordinate equipment assistance and data processing assistance. Scientists at FIU and at the District are currently looking for funds to organize support efforts to ensure long-term maintenance of towers, equipment updating, and data processing for towers in coastal mangroves and in Shark River Slough, as well as identifying locations for new towers (e.g., an STA).

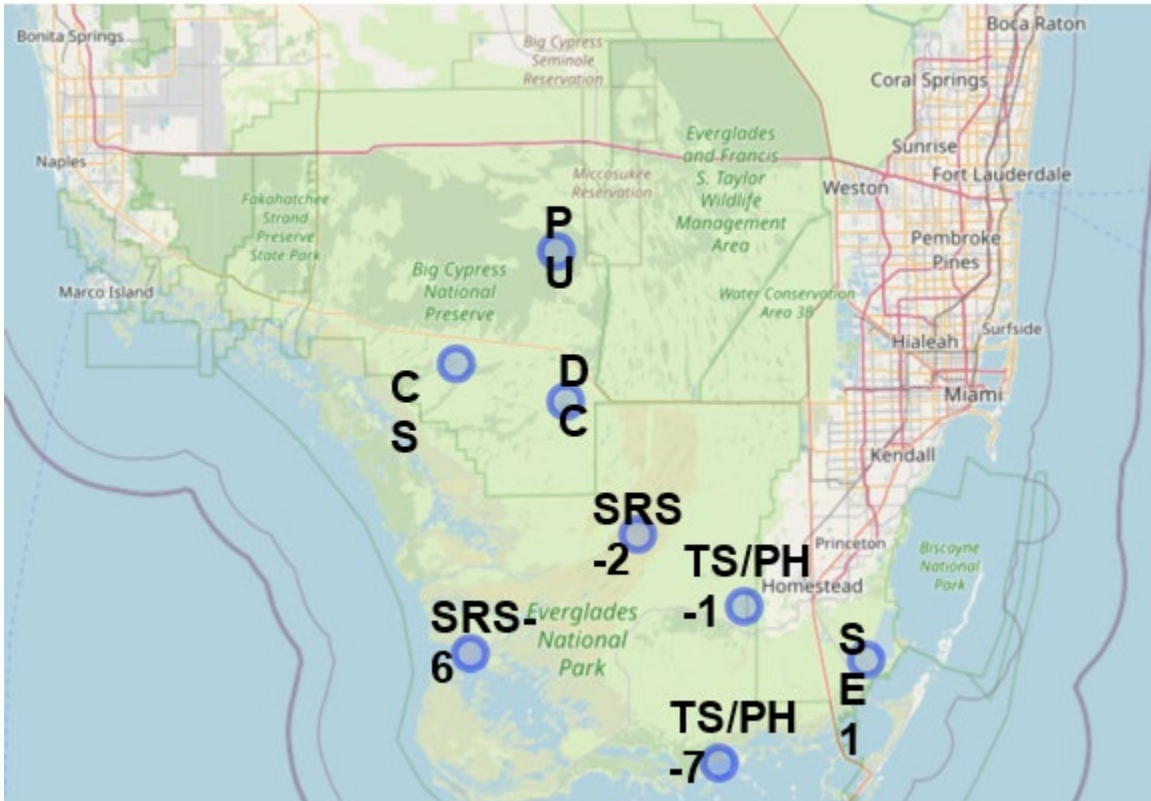

Figure 10-2: Everglades eddy covariance tower sites.

Table 10-1: Covariance Towers, principle investigators, permit and network association.

Tower	Investigators	ENP Permit	Network Association
SRS6	Tiffany Troxler	EVER-2019-SCI-005	FCE-LTER
TS/Ph-7	Edward Castenada Sparkle L. Malone	EVER-2019-SCI-0055	FCE-LTER
TS/Ph-1	Steven F. Oberbauer	EVER-2019-SCI-0055	FCE-LTER/Ameriflux
SRS-2	Gregory Starr	EVER-2021-SCI-0035	FCE-LTER/Ameriflux
SE-1	Christina Staudhammer	NA	FCE-LTER/Ameriflux
DC	Barclay Shoemaker	NA	FCE-LTER/Ameriflux
PU	Andrea Daniels		
CS	Sparkle Malone		

The existing towers are managed by various groups of investigators, though they have similar setups and are all associated with the Florida Coastal Everglades Long-term Ecological Research (FCE-LTER).

Cost estimates

Flux Towers - Instrumentation

Tower instrumentation requires upgrades and replacement every 5-10 years (Table 5-2). The current priority for instrumentation is to add methane analyzers to TS-PH-7, PU, and CS. In addition to the \$90K needed to add methane to towers, an annual instrumentation budget of \$30K is necessary to replace equipment.

Table 10-2: Major instrumentation for the eddy covariance method.

Description	Instrument Used	Estimate
Shortwave/Longwave (<i>pyranometer</i>) solar radiation/terrestrial	CNR4-L net radiometer	\$28,000
Wind speed /direction	<u>05103-L Wind Monitor</u>	
Air temp and RH	<u>RAD10E</u>	
Sonic anemometer- 3D wind speed and direction		
Incoming PAR density- LI-250Q	Quantum sensor	\$1,200
LI-7500		\$78,527
LI-7700		
CR1000		\$5,000
CR3000		
	Total per tower	\$112,727

Major instrumentation for the eddy covariance method include radiation, gas analyzers, and sonic anemometers. These costs represent the cost of deploying one flux tower. Scientists at the District and FIU are in the process of determining how many towers are needed and where they should be deployed.

Personnel Support

To support fieldwork for the maintenance of all tower sites, a full-time technician (\$65K/ per year) will be available to assist all investigators in data collection and uploading to a general server. Data processing will be done by the Malone Disturbance Ecology Lab through the partial support of a postdoctoral scholar who will assist with data processing and research (\$50K/ year).

Table 10-3: Total annual budget for the Greater Everglades Carbon Project

Description	Category	Estimate
LI-7700; CH4 analyzer	Equipment	90K* onetime
Repairs and replacements	Equipment	30K
Personnel	Field Technician	65K
Personnel	Data Processing	50K
Total		145,000 /Year + 90K

*Overhead is not included in current estimates.

Soil Accretion Monitoring

It is difficult to define a total, comprehensive cost for monitoring accretion because the total number of new SET-MH sites is not yet known. However, personal experience indicates that an additional 16 sites are likely the maximum needed to capture the full suite of habitats, hydrological conditions, and water management options. This would include 2 sites in the ENP, 6 sites in WCA-3, 2 sites in WCA-2A, 3 sites in an STA, and 3 sites in Big Cypress. It may be possible to acquire significant data with only 10 additional SET-MH sites. These costs below assume that the District FTE contribution is limited to 0.4 FTE per year.

Phase 1: \$75,000

Phase 2 and Phase 3:

Average Installation Labor and Equipment Cost per station: \$30,000.

Average Annual Labor, Lab and Field Monitoring Cost per station: \$20,000

Year 1 Total Cost for 16 sites: \$480,000

Year 1 Total Cost for 10 sites: \$300,000

Year 2 Annual Monitoring Cost for 16 sites: \$320,000

Year 2 Annual Monitoring Cost for 10 sites: \$200,000

The Total for 5 years of monitoring is between \$1.0 and \$2.0 million.

Total Cost for 6 years (5-yr of monitoring) for 16 sites: \$2,080,000

Total Cost for 6 years (5-yr of monitoring) for 10 sites: \$1,000,000

Phase 4: \$175,000

Total Cost Range: \$1,250,000 -- \$2,330,000

Final Comments and Next Steps

In coordination with the Florida Department of Environmental Protection, other State and Federal Agencies, and local governments, the District is making infrastructure adaptation investments that are needed to continue to successfully implement its mission. This plan presents a comprehensive list of priority resiliency projects with the goal of reducing the risks of flooding, SLR, and other climate impacts on water resources and increasing community and ecosystem resiliency in South Florida. This list of projects was compiled based on vulnerability assessments that have been ongoing for the past decade. These assessments utilize extensive data observations and robust technical hydrologic and hydraulic model simulations to characterize current and future conditions and associated risks.

The list of priority resiliency projects includes investments needed to increase the resiliency of the District's coastal structures, including structure enhancement recommendations and additional SLR adaptation needs. These projects represent urgent actions to address the vulnerability of the existing flood protection infrastructure. Project recommendations also comprise basin-wide flood adaptation strategies that are based upon other FPLOS recommendations and water supply and water resources of the State protection efforts. Important planning projects are also presented to continuously advance vulnerability assessments and scientific data and research to ensure the District's resiliency planning and projects are founded on the best available science and advanced technical analyses.

Through collaboration with local municipalities, Counties, Regional Climate Compacts, and State and Federal Agencies, the projects being proposed in this Plan are discussed and integrated into regional strategies to promote resiliency, which include other structural and non-structural adaptation and mitigation measures, flood-proofing, road elevations, relocation, other local drainage improvements, shoreline stabilization, living shorelines, beach restoration, ecosystem restoration, water resources protection, and others.

Among the next steps for the implementation of the project recommendations included in this plan, the District continues to seek funding alternatives at the State and Federal levels. At the State level, in May 2021, Governor Ron DeSantis signed Florida Senate Bill 1954, which created the Resilient Florida Program, providing significant funding to support flooding and SLR resiliency projects throughout the State. In May 2022, Governor DeSantis approved House Bill 7053, which established further efforts toward Statewide Flooding and Sea Level Rise Resilience. In January 2023, Governor DeSantis signed Executive Order 23-06 to direct funding and strategic action to continue to support the Resilient Florida

Program. The District was recently awarded approximately \$19 million from this program to support project implementation, with additional funding also being awarded in partnership with Palm Beach County.

At the Federal level, Federal Emergency Management Agency (FEMA) mitigation and adaptation funding is under consideration, and the District is working to finalize a grant agreement with FDEM for the \$50 million award recommendation received from FEMA Building Resilient Infrastructure and Communities (BRIC) Program for the C-8 Basin Resiliency Project. In addition, the District and USACE initiated the C&SF Flood Resiliency Study to recommend adaptation strategies to build flood resiliency in the Communities served by the C&SF Systems. This study was initiated in the Fall of 2022 under the existing authority of the Flood Control Act of 1970 – Section 216 and is currently leveraging advanced hydrologic, hydraulic, and/or hydrodynamic models, representing surface water systems and associated operational rules, as well as groundwater and ocean/coastal water interaction developed under the South Florida Water Management District’s Flood Protection Level of Service (FPLOS) Program and USACE’s South Atlantic Coastal Study (22). The Section 216 Study focuses on the highly vulnerable infrastructure that can reduce the most immediate flood risk to changing hydrodynamic and climate conditions and the resilience aspects of such infrastructure and is being conducted in coordination with stakeholders, Federal agencies, State, Tribal, and local officials. USACE and the SFWMD are 50/50 cost-sharing partners. The results of this study will allow the immediate authorization of subsequent design and construction phases, and the Final Chief’s Report is estimated to be finalized by May 2026.

Finally, the District is committed to continue promoting regional coordination and partnership opportunities by holding proactive discussions, leveraging technical knowledge, and exchanging information. The SFWMD Resiliency Public Forum was kicked off in December 2022 to promote collaboration on water management initiatives related to resiliency and further engage partners on the impacts of changing climate conditions and water management implications, now and into the future. This forum, which meets quarterly, will continue to foster a constructive environment to discuss tangible asset-level solutions and support decision-making on water resource management.

References

1. **South Florida Water Management District.** Resiliency Coordination Forum. *South Florida Water Management District - Our Work*. [Online] 2023. <https://www.sfwmd.gov/our-work/resiliency-coordination-forum>.
2. Flood Protection Level of Service (LOS) Analysis for the C-4 Watershed. West Palm Beach, Florida, United States : Hydrology and Hydraulics Bureau, May 19, 2016. p. 384.
3. **ADA Engineering.** Flood Protection Level of Service for the Basins C7, C8 and C9: Identification and Mitigation of Sea Level Rise Impacts. *Deliverable 3.4.1 Final Report - Flood Protection Level of Service Provided by Existing District Infrastructure for Current (2015) Sea Level Conditions and Three Future (2065 Sea Level Rise Scenarios for the C7 Basin)*. Doral, Florida, United States : South Florida Water Management District, June 2017.
4. **Parsons.** Flood Protection Level of Service Provided by Existing District Infrastructure for Current (2015) Sea Level Conditions and Three Future (2065) Sea Level Scenarios for Golden Gate Watershed - Final Report. *Flood Protection Level of Service in Golden Gate, Cocohatchee, Henderson-Belle Meade, and Faka Union Watersheds*. West Palm Beach, Florida, United States : South Florida Water Management District, October 26, 2017. p. 1294.
5. **Taylor Engineering, Inc.** Flood Protection Level of Service - Existing Infrastructure for Current and Future Sea Level Conditions in the C8 and C9 Watersheds. *Final Comprehensive Report Deliverables 5.2*. s.l., Tampa, Florida : South Florida Water Management District, January 2021.
6. **U.S. Geological Survey.** Development of Projected Depth-Duration-Frequency Curves (2050-89) for South Florida. *Scientific Investigations Report 2022-5093*. Reston, Virginia : s.n., 2022.
7. **South Florida Water Management District.** Future Extreme Rainfall Change Factors for Flood Resiliency Planning in South Florida Web Application. *Resilience Metrics Hub*. [Online] May 26, 2022. <https://sfwmd-district-resiliency-sfwmd.hub.arcgis.com/apps/0616cf4890424ec8bd8a0f901dee7cf0/explore>.
8. **U.S. Geological Survey.** Change factors to derive projected future precipitation depth-duration-frequency (DDF) curves at 174 National Oceanic and Atmospheric Administration (NOAA) Atlas 14 stations in central and south Florida. *ScienceBase Catalog*. [Online] April 1, 2022. <https://www.sciencebase.gov/catalog/item/62420146d34e915b67eae181>.
9. **UN Environment-DHI, UN Environment and IUCN 2018.** *Nature-Based Solutions for Water Management: A Primer*. 2020.
10. **Office of Everglades Restoration Initiatives.** Restoring America's Everglades. [Online] [Cited: August 18, 2023.] <https://www.evergladesrestoration.gov/>.
11. **U.S. Army Corps of Engineers.** Ecosystem Restorations. *Jacksonville District*. [Online] [Cited: August 18, 2023.] <https://www.saj.usace.army.mil/Missions/Environmental/Ecosystem-Restoration/>.
12. **South Florida Water Management District.** CERP Project Planning. [Online] [Cited: August 18, 2023.] <https://www.sfwmd.gov/our-work/cerp-project-planning>.

13. **U.S. Army Corps of Engineers.** Integrated Delivery Schedule. *Jacksonville District*. [Online] [Cited: August 18, 2023.] <https://www.saj.usace.army.mil/Missions/Environmental/Ecosystem-Restoration/Integrated-Delivery-Schedule/>.
14. **Sklar, F.H., et al.** The Everglades: At the Forefront of Transition. 2019.
15. **Sweet, W. V., et al.** Global and Regional Sea Level Rise Scenarios for the United States. *NOAA Technical Report NOS CO-OPS 083*. Silver Spring, Maryland : National Oceanic and Atmospheric Administration, 2017.
16. **Ross, M. S., et al.** The Southeast Saline Everglades revisited: 50 years of coastal vegetation change. s.l. : *Journal of Vegetation Science*, 2000. Vols. 11:101-112.
17. **Sklar, F. H., et al.** Coastal Ecosystem Vulnerability and Sea Level Rise (SLR) in South Florida: A Mangrove Transition Projection. s.l. : *Frontiers in Ecology and Evolution*, May 25, 2021. Vols. Volume 9 - 2021 | <https://doi.org/10.3389/fevo.2021.646083>.
18. **South Florida Water Management District.** Salinity in the Everglades. *Resilience Metrics Hub*. [Online] August 18, 2023. <https://sfwmd-district-resiliency-sfwmd.hub.arcgis.com/apps/salinity-in-the-everglades/explore>.
19. —. DBHYDRO. [Online] https://my.sfwmd.gov/dbhydroplsql/show_dbkey_info.main_menu.
20. —. Flood Mitigation and Adaptation Projects. *Build Community Resilience*. [Online] [Cited: August 21, 2023.] <http://www.buildcommunityresilience.com/SFWMD/FPLOS/c8c9/>.
21. —. Flood Mitigation and Adaptive Projects. *Build Community Resilience*. [Online] August 18, 2023. <https://www.buildcommunityresilience.com/SFWMD/FPLOS/c8c9/#>.
22. **Merriam-Webster.** Dictionary. [Online] August 17, 2023. <https://www.merriam-webster.com/thesaurus/resilience>.
23. **South Florida Ecosystem Restoration Task Force.** Restoring, preserving, and protecting the South Florida Ecosystem. *National Park Service and Office of Everglades Restoration Initiatives*. West Palm Beach, Florida, United States : South Florida Ecosystem Restoration Task Force, May 27, 2022.

Glossary of Terms

Term	Definition
BRIC	Baseline Resilience Indicators for Communities
C&SF	Central & Southern Florida
CEJST	Climate and Economic Justice Screening Tool
CEQ	Council on Environmental Quality
CIP	Capital Improvement Plan
CIP	Capital Improvement Program
District	South Florida Water Management District
EAL	Expected Annual Loss
EJ	Environmental Justice
EMMA	Everglades Mangrove Migration Assessment
FAS	Floridan Aquifer System
FEMA	Federal Emergency Management Agency
FIAT	Flood Impact Assessment Tool
FPLOS	Flood Protection Level of Service
HVRI	Hazards Vulnerability & Resilience Institute
MH	Marker Horizons
NOAA	National Oceanographic and Atmospheric Association
NRI	National Risk Index
NWS	National Weather Service
RSMAS	Rosenstiel School of Marine and Atmospheric Science
SETs	Surface Elevation Tables
SFWMD	South Florida Water Management District
SIP	Structure Inspection Program
SJRWMD	St. Johns River Water Management District
SLR	Sea Level Rise
STAs	Stormwater Treatment Areas
TMDLs	Total Maximum Daily Loads
UM	University of Miami
USACE	U.S. Army Corps of Engineers
USDA	U.S. Department of Agriculture
USGS	U.S. Geological Survey
WCA	Water Conservation Area

APPENDIX A – FPLOS PHASE I – INITIAL PROJECT RECOMMENDATIONS

ID	Type	Project Name	Status	Sub-Basin	Mitigation Strategy ID	Comment
A1	Canal Bank Elevation	Raise canal banks at selected locations on the C-14 Canal	Consultant	C-14 Basin	BC_2.3	As part of the PM #1 analysis presented in Deliverable 4.2A, Taylor Engineering compared peak canal stages with canal bank elevations. Although the C-14 Canal is predicted to mostly contain the 100-year return period design storm within its banks for all three sea level rise scenarios simulated, there are a few localized locations of exceedance. Of the three locations with significant bank exceedance levels, only one is predicted to directly result in inundation of developed lands, which was the metric used to identify deficiencies in this study. The FPLOS Report shows the location proposed for canal bank improvements. The proposed bank improvement would involve raising about 1200 linear ft of the 1700 ft section shown on the north side of the canal to form a more elevated continuous embankment.
A2	Dredging	C-14 Canal dredging in areas with significant head loss	Consultant		BC_2.4	One potential way to reduce stages in the C-14 Canal would be to dredge the canal in areas with significant head loss. The canal bottom profile can be compared to the canal design bottom elevation to identify areas with sediment accumulation. Based on the 25-year design storm simulation results, there is a predicted head loss of about 0.60 ft to 0.74 ft (decreasing as SLR increases) over the 9400 ft stretch of canal between the Sunshine WCD PS1 outfall and South State Road 7, and 1.0 ft to 1.23 ft (decreasing as SLR increases) over the 13500 ft stretch of canal between South State Road 7 and Structure S-37B. These areas could benefit from dredging if the existing canal conditions have deteriorated compared to the design conditions. Regardless of whether the existing canal conditions in these areas have deteriorated compared to design, it is possible that deepening the canal to improve conveyance could reduce peak canal stages. Dredging in areas with significant head loss may reduce or eliminate the need to raise the embankment shown in Figure 2, which could be analyzed in the next phase of this FPLOS study. Although dredging in areas with significant head loss could reduce peak canal stages, it is unlikely enough to eliminate the need for the addition of pumps or gates on the secondary system in the North Lauderdale area.

ID	Type	Project Name	Status	Sub-Basin	Mitigation Strategy ID	Comment
A3	Canal Bank Elevation	Raise canal banks on the Cypress Creek Canal (C-14)	Consultant	C-14 East Basin	BC_3.2	If, in the future SLR scenarios, it is no longer feasible or cost effective to maintain stages in the primary canals at acceptable levels, it may be necessary to consider raising the levees along the primary canal to reduce overland flooding as a result of bank exceedance. However, this strategy alone would not reduce flooding as a result of elevated stages in the primary canal inhibiting gravity-driven discharge from the secondary system. Therefore, this mitigation strategy could be implemented as necessary in select locations that would still experience bank exceedance after Structure S-37A Improvements (mitigation strategy 1) have been implemented, which can be determined through future model simulations.
A4	Dredging	C-14 Canal dredging in areas with significant head loss	Consultant		BC_3.3	One potential way to reduce stages in the Cypress Creek Canal would be to dredge the canal in areas with significant head loss. The canal bottom profile can be compared to the canal design bottom elevation to identify areas with sediment accumulation. Based on the 10-year design storm simulation results, there is a predicted head loss of about 0.3 ft over the 1 mile stretch of canal between W Palm Aire Drive and FL-845 (Powerline Road) and 0.2 ft over the 3500 ft stretch of canal between FL-845 and the Train Tracks Bridge.
A5	Canal Bank Elevation	Raise canal banks along the C-13 Canal	Consultant	C-13 WEST BASIN	BC_5.2	If, in the future SLR scenarios, it is no longer feasible or cost effective to maintain stages in the primary canals at acceptable levels, it may be necessary to consider raising the levees along the C-13 Canal
A6	Canal Bank Elevation	Raise North New River Canal Banks at Select Location(s)	Consultant	NORTH NEW RIVER WEST BASIN	BC_7.3	If, in the future SLR scenarios, it is no longer feasible or cost effective to maintain stages in the primary canal at acceptable levels, it may be necessary to consider raising the canal levees to reduce overland flooding as a result of bank exceedance. For the North New River Canal, only one instance of bank exceedance was predicted during the future condition simulations (upstream and downstream 124th Ave (N Flamingo Rd)), which was the primary deficiency that impacts the assigned flood protection level of service. Raising the segment of canal embankment identified in Deliverable 4.2B would increase the level of service and is likely a very feasible project to implement. The proposed bank improvement would involve raising about 2800 linear ft of

ID	Type	Project Name	Status	Sub-Basin	Mitigation Strategy ID	Comment
						the 3600 ft section shown on the north side of the canal to form a more elevated continuous embankment. It is possible that this strategy would not be required if Structure G-54 follows salinity control operations discussed in Section 8.1, which future modeling simulations can address.
A7	Dredging	North New River Canal dredging in areas with significant head loss	Consultant		BC_7.4	One potential way to reduce stages in the North New River Canal would be to dredge the canal in areas with significant head loss. The canal bottom profile can be compared to the canal design bottom elevation to identify areas with sediment accumulation. Based on the 25-year design storm simulation results, there is a predicted head loss of about 0.3 ft to 0.83 ft (decreasing as SLR increases) over the 3 mile stretch of canal between Hiatus Rd and N University Dr (FL-817), and 0.14 to 0.46 ft (decreasing as SLR increases) over the 7000 ft stretch of canal between N University Dr and Structure G-54. These areas could benefit from dredging if the existing canal conditions have deteriorated compared to the design conditions. The head loss through the North New River Canal should be analyzed again after the salinity control operations discussed in Section 8.1 have been included in future model simulations. Dredging in areas with significant head loss may eliminate the need to raise the embankment, which could be analyzed in the next phase of this FPLOS study.
A8	Dredging	Improve C-11 conveyance capacity / operation modification	Consultant	C-11 WEST BASIN	BC_8.2	One potential way to reduce the duration of flooding is to increase the conveyance capacity of the C-11 Canal so that the pump has less "down-time". Based on standard operating criteria, the S-9/S-9A Pump Station reduces discharge when the headwater drops below 1.0 ft NGVD29 and may turn off completely if the water elevation drops below 0.0 ft NGVD29 until the minimum pool elevation is re-established. Increasing channel conveyance capacity could increase the water level upstream of the pumps which would allow them to stay at peak discharge longer, as well as reducing upstream water levels. One potential way of improving canal conveyance is to dredge the primary canal (back to design condition in areas with significant head loss of sediment deposition) or deepen the canal beyond design conditions. Based on the future condition simulations,

ID	Type	Project Name	Status	Sub-Basin	Mitigation Strategy ID	Comment
						this strategy would not likely reduce peak flood depths as the pumps are at peak capacity during those times. However, it could reduce the duration that the primary canal is elevated, ultimately reducing the duration of flooding.
A9	Pumps	Structure S-13 Improvements Option 1	Consultant	C-11 EAST BASIN	BC_9.1	Structure S-13 is the tidal outfall structure for the C-11 East Basin and is composed of a pump station and an underflow gate. Regardless of gate position, water will bypass this structure at an elevation of 8.0 ft NGVD29 (SFWMD H&H Bureau, 2020), which was not predicted to occur based on District-provided storm surge data. However, the S-13 peak tailwater used for the 100-year SLR3 scenario is within 0.04 ft of bypassing/overlapping the structure. The S-13 underflow gate closes whenever the tailwater elevation gets within 0.1 ft of the headwater elevation. Under future condition sea level rise, the S-13 tailwater stage will often exceed the headwater stage, which forces the underflow gate to remain closed, which significantly reduces the discharge. Structure improvements would involve re-building or modifying the S-13 structure to include more (or larger) forward pumps and increase the heights of the platform to reduce the potential for overtopping/bypass. Due to the low elevation of the C-11 East Basin, sea level rise will likely make a gravity structure such as the S-13 underflow gate impractical. Although the gate is still able to discharge at times during the simulated sea level rise design storms, it does so with upstream water level elevations that cause flooding. Therefore, to reduce flooding and increase FPLOS, increased pump capacity is required.
B1	Canal Improvements (New Canal, Extension, Widening, Realignment)	Canal re-alignment	Consultant	C-2 East	C2_1.2	<p>The tidal section of the Snapper Creek Canal from the S22 structure to the Biscayne Bay is primarily within the R Hardy Matheson County Preserve, and is currently a straight line from the structure to the Bay; however, the historical channel followed a more natural path, winding northeast, splitting and rejoining along the way to the coast, as shown in Figure 2-3 (Miami-Dade County, 2012). This natural pathway may have reduced the wave energy coming from storm surge and tidal surge.</p> <p>By increasing the number of bends in the existing canal and/or re-aligning the canal to follow a more natural</p>

ID	Type	Project Name	Status	Sub-Basin	Mitigation Strategy ID	Comment
						<p>pathway, the wave energy should be reduced, and storm related surge may be less intense at the S22 structure. Some examples of these canal re-alignments are shown in Figure 2-4 A and B. Any changes to the mangrove and coastal vegetation communities may require habitat restoration and/or wetland mitigation.</p> <p>Canal conveyence capacity for the section of the Snapper Creek Canal downstream of the S22 structure will require further evaluation and modeling to determine the effects on downstream stages.</p> <p>In addition, canal and shoreline stablization can be implemented using living shoreline techniques along the areas highlighted in purple in panel C of Figure 2-4. Living shorelines utilize natural edging to increase stability along coastlines (NOAA, 2015). Since this area is already a mangrove habitat, stabilization here may mean adding oyster beds and breakwater habitats to reduce erosion and impact to these mangrove habitats.</p>
B2	Canal Bank Elevation	Raising canal embankments in problem areas	Consultant	C-2 Central (Upland)	C2_2.1	<p>Raising the elevation of the canal banks will help reduce overtopping of embankments from the canals to the overland elevations during the peak of the storm events. For the C2 Watershed there are several locations where raising the embankments can provide immediate relief during extreme rainfall and surge events with high canal stages. To review the deficiency of these embankment heights, a comparison was made with the 2022 Miami-Dade County Flood Criteria map, which is based on a 10-year, 24-hour storm event, 2060 scenario with SLR. Figure 2-5 shows the difference of the modeled embankment elevations minus the Miami-Dade Flood Criteria (MDFC) map elevations. In the figure, embankment elevations that are less than a foot above the MDFC are colored with greens and blues, and therefore less urgent in their potential upgrades. Reds and oranges are more urgent, as these embankment locations are much lower than the MDFC. The following areas (also indicated in the figure with yellow dashed lines) may benefit from embankment improvements:</p> <ol style="list-style-type: none"> 1. Snapper Creek Canal <ol style="list-style-type: none"> a) Low sections along SW 117th Ave on the eastern

ID	Type	Project Name	Status	Sub-Basin	Mitigation Strategy ID	Comment
						embankment from Coral Way to N Snapper Creek Dr b) Low Sections along N Snapper Creek Dr on the north embankment and along the south embankment c) Low portion from S.R. 826 to Ludlam Glade Canal d) Low section upstream of SW 57th Ave Bridge near SW 88th St e) Low section upstream of S22 structure 2. SW 60th St Canal – southern embankment from SW 127th Ave to the Turnpike 3. SW 144th Ave Canal – full canal 4. Westwood Lakes Canal – full canal
B3	Distributed Storage	Temporary storage in parks/golf courses	Consultant		C2_2.2	To provide additional storage within the watersheds, Miami-Dade County parks or golf courses can potentially be used as emergency temporary storage. A majority of these parks are at lower elevations than average grade. Green infrastructure can be implemented at these parks to allow for recreational use during dry periods while also being able to provide storage during storm events. The C2 Watershed has few non-urban areas and recreational areas that may be considered for use as temporary storage areas during extreme rainfall events. As previously mentioned, the Miccosukee Country Club along SW 60th St Canal is in-line with the secondary canal and may already have naturally lower embankments that likely provide some floodplain storage. However, this golf course could be enhanced to provide additional dry detention, and/or regraded to allow the canal to overflow onto the natural areas. A map of the Miami-Dade County Parks, municipal parks, and golf courses are provided for the C2 and C3W watersheds in Figure 2-6. Some parks have also been identified in the C2 Watershed that can provide a similar service. These include: 1. Tamiami Park – although this park is in the C4 Watershed, this location could take overflow from Snapper Creek on the west side across NW 117th Ave 2. Kendall Indian Hammocks Park – this large park is not adjacent to any canal, but additional connections could be considered and/or storm drain pipes can provide canal connections 3. Boys and Girls Club of Miami fields – these fields are located at the Snapper Creek Canal and the Don Shula

ID	Type	Project Name	Status	Sub-Basin	Mitigation Strategy ID	Comment
						Expressway 4. West Matheson Hammock Park and others – several natural areas in the South Miami/Pinecrest area are adjacent to the Snapper Creek Canal and may provide additional storage due to their naturally low topography (includes Dante Fascell Park, Banyan Drive Park, Red Road Linear Park, etc.)
B4	Storage areas	Acquire storage in western mining lakes with water control structures in Bird Drive Extension Canal to convey water to storage facilities	Consultant	C-2 Western (Rock Mines)	C2_3.1	As part of the Central Everglades Restoration Plan (CERP), the area shown in Figure 2-13 was proposed to have an above-ground impounded recharge area of 2,877 acres, providing 11,500 ac-ft of storage. The goals were to 1) reduce seepage from Everglades National Park, 2) recharge groundwater east of Krome Avenue, 3) increase C4 peak flood attenuation, 4) allow water supply deliveries to the South Dade Conveyance System, and 5) increase spatial extent of wetlands. This project, known as the Bird Drive Recharge Area, was screened out as the concept as envisioned in the Yellow Book was “not feasible” due to the high cost/low benefit ratio (SFWMD, 2011). In terms of flood control, it was stated that the flood attenuation benefits were diminished due to the C4 Emergency Detention Basin. As shown in the FPLOS scenario analysis, during the 100-year/72-hour current condition simulation the C4 detention basin reaches capacity (i.e. max water level of 8.44 ft-NAVD or 10 ft-NGVD), and during the 25-year/72-hour the detention basin reaches capacity for the future SLR conditions, as further discussed in Section 7.1. In addition, the Bird Drive Recharge Area could provide flood relief for multiple basins such as the C2, C3W, C4, and C5 basins. This area should be reevaluated as a flood control option, similar to the C4 Detention Basin. This area is directly adjacent to the Bird Drive Extension Canal. Additional structures can be added to the Bird Drive Extension Canal to provide operational flexibility.
B5	New Structure (Spillway)	Additional salinity structure or storm surge/tidal barrier at the end of the C-3 Canal (potentially with navigational accessibility)	Consultant	C-3 East	C3_1.2	G93, the salinity structure for the C3 Canal, is over 4.1 miles from the outlet at Biscayne Bay. The downstream area of G93 passes through the Biltmore Golf Course and through highly urbanized South Miami and Coral Gables. An additional salinity structure could be added closer to Biscayne Bay to limit the effect of storm surge and/or SLR on the C3 and C3W Basins, while also

ID	Type	Project Name	Status	Sub-Basin	Mitigation Strategy ID	Comment
						<p>providing more discharge capacity for the G93 structure. A potential location for this structure is the area around Cocoplum Circle, near Ingraham Park, as shown in Figure 3-3. There is an existing Cocoplum Road Pedestrian Bridge that could tie-in with the design and capabilities of a new salinity structure.</p> <p>While this structure could significantly reduce impacts from SLR and storm surge in Coral Gables all the way to Red Road, a standard sluice gate implemented at this location would eliminate recreational and commercial navigation upstream. However, implementation of a miter gate would maintain the canal as a navigable until the gates are closed during high tide events. Miter gates consist of a pair of gates, anchored to reinforced concrete abutments at either river bank, that swing out and meet at an angle pointing toward the upstream direction. Because of this design, the gate would only be operable when the tides are higher than the canal levels (as indicated at G93_T) and could not be used to control flows out of the system. A miter gate would also limit the impacts to wildlife that currently uses the channel, i.e. manatees and fish.</p>
B6	Canal Bank Elevation	Raising C-3 canal embankments in problem areas	Consultant	C-3 Central (Upland)	C3_2.1	<p>Raising canal banks will help reduce overtopping of embankments from the canals to the overland elevations during the peak of the storm events. For the C3W and C3 Watersheds areas primarily near and just downstream of the G93 structure would benefit from higher bank elevations. To review the deficiency of these embankment heights, a comparison was made with the 2022 Miami-Dade County Flood Criteria map, which is based on a 10-year, 24-hour storm event, 2060 scenario with SLR. Figure 3-4 shows the difference of the modeled embankment elevations minus the Miami-Dade Flood Criteria (MDFC) map elevations. In the figure, embankment elevations that are less than a foot above the MDFC are colored with greens and blues, and therefore less urgent in their potential upgrades. Reds and oranges are more urgent, as these embankment locations are much lower than the MDFC. The following areas may benefit from embankment improvements:</p> <ol style="list-style-type: none"> 1. Coral Gables Canal

ID	Type	Project Name	Status	Sub-Basin	Mitigation Strategy ID	Comment
						<p>a. Low section at intersection with the C4 Canal b. Low section upstream of G93 structure c. Low sections downstream of where the canal diverges to US1 (this does not include the Biltmore golf course, which can be used for emergency storage during high storm events)</p>
B7	Distributed Storage	Temporary storage in parks/golf courses	Consultant		C3_2.2	<p>Because the C3W basin is entirely within the eastern and highly urbanized portion of Miami-Dade County, there is no land readily available for regional storage. To provide additional storage within the C3W Watershed, Miami-Dade County parks or golf courses can potentially be used as emergency temporary storage. A majority of these parks are at lower elevations. Green infrastructure can be implemented at these parks to allow for recreational use during dry periods while also being able to provide storage during storm events. A map of the Miami-Dade County Parks, municipal parks, and golf courses are provided for the C2 and C3W watersheds in Figure 2-6. For example, A.D. Barnes Park is located upstream of G93 and could potentially be used for temporary storage to limit the amount of water coming out of the basin during a storm event. This is critical for the C3W Basin as there is a significant amount of urbanized area downstream of G93 and discharging too much water from the watershed in a short amount of time can contribute to flooding in the C3 Watershed. Downstream of the G93 structure, the Coral Gables Canal can utilize the low embankments of the Biltmore Golf Course to provide additional floodplain storage during high intensity rainfall events. Topography in these golf courses or parks must be reviewed to ensure that new connections to the canal floodplain do not create new paths to structures or residences nearby. Some park facilities may need to be elevated and berms may be required to control the flooding extent.</p>
B8	Canal Bank Elevation	Raising canal embankments in problem areas	Consultant	C-4 Central (Upland)	C4_2.1	<p>Raising canal levees will help reduce overtopping of embankments from the canals to the overland elevations during the peak of the storm events. For the C4 Watershed there are several locations where raising the embankments can provide immediate relief during extreme rainfall and surge events with high canal stages. To review the deficiency of these embankment heights, a</p>

ID	Type	Project Name	Status	Sub-Basin	Mitigation Strategy ID	Comment
						<p>comparison was made with the 2022 Miami-Dade County Flood Criteria map, which is based on a 10-year, 24-hour storm event, 2060 scenario with SLR. Figure 4-3 shows the difference of the modeled embankment elevations minus the Miami-Dade Flood Criteria (MDFC) map elevations. In the figure, embankment elevations that are less than a foot above the MDFC are colored with greens and blues, and therefore less urgent in their potential upgrades. Reds and oranges are more urgent, as these embankment locations are much lower than the MDFC. The following areas may benefit from embankment improvements:</p> <ol style="list-style-type: none"> 1. Snapper Creek Canal Extension between NW 25th St and NW 74th St 2. Northline Canal – between Snapper Creek Canal Extension and the Palmetto Expy 3. NorthlineNS_C4 – along the Palmetto Expy from the Northline Canal to the Dolphin Expy 4. SW97Ave_North_Canal – near Fontainebleau community 5. Coral Way Canal – along SW 24th St 6. C4 Canal – between SW142nd Ave and SW 122nd Ave 7. S4 Canal – near S25B structure and the International Links golf course
B9	Distributed Storage	Temporary storage in parks/golf courses	Consultant		C4_2.2	<p>To provide additional storage within the watersheds, Miami-Dade County parks or golf courses can potentially be used as emergency temporary storage. A majority of these parks are at lower elevations. Green infrastructure can be implemented at these parks to allow for recreational use during dry periods while also being able to provide storage during storm events. The C4 Watershed has many non-urban areas and recreational areas that may be considered for use as temporary storage areas during extreme rainfall events. A map of the Miami-Dade County Parks, municipal parks, and golf courses are provided for the C4 watershed in Figure 4-4. Golf courses that are in-line with the secondary canals may already have naturally lower embankments or may require embankment degradation to promote overbank spilling in controlled areas. There are no golf courses within the C4 Watershed, however, immediately</p>

ID	Type	Project Name	Status	Sub-Basin	Mitigation Strategy ID	Comment
						<p>downstream and south of the S25B structure is the International Links golf course, which may already be providing some floodplain storage during extreme events, and may be potentially improved to increase this floodplain storage in conjunction with improvements to the S25B structure such as tie-back levees.</p> <p>Parks can also be used for temporary floodplain storage during large storm events by degrading the canal embankments and creating what is essentially a dry detention area connected to the canal. There are very few large parks within the watershed, however, the following may be utilized for temporary storage:</p> <ol style="list-style-type: none"> 1. FPL Linear Park – a utility easement that runs parallel to Mud Creek Canal 2. Tamiami Park – adjacent to the Coral Way Canal 3. Carlos Arboleya Camping and Picnic Ground – adjacent to the C4 Canal and Lake Mahar <p>In either strategy, topography in these golf courses or parks must be reviewed to ensure that new connections to the canal floodplain do not create new paths to structures or residences nearby.</p> <p>While not listed as a park, an additional utility easement is located just west of the connection between the C4 Canal and Coral Way Canal, shown in Figure 4-5. Low embankments at this location along the C4 Canal have been identified in the modeling and already experiences overtopping during the current conditions 100-year/3-day storm event. However, additional storage may be possible farther away from the canal within this easement.</p>
B10	Pumps	S-380 Structure Upgrades (Pumps)	Consultant	C-4 Western (Rock Mines)	C4_3.1B	<p>The following recommendations should be considered:</p> <ol style="list-style-type: none"> 2) Potential upgrades for this purpose include installing a backflow pump and raising the structure elevation. In addition, the northern levee along the C4 Canal within the Pennsuco wetlands region could be degraded to be below the top of the S380 structure to provide additional overflow to the wetlands area with increasing normal discharge from the wetlands to the C4 Canal.
B11	Storage areas	Acquire storage areas in western mining lakes (Central Lake Belt Storage Area)	Consultant		C4_3.3	<p>Another option to provide more storage in the C4 Watershed is to connect and utilize the mining lakes west of the Turnpike as storage and emergency detention. Within the C4 Watershed, there is over 6,000</p>

ID	Type	Project Name	Status	Sub-Basin	Mitigation Strategy ID	Comment
						<p>acres of existing mine lakes that have completed their operations and are currently serving no additional purpose. These open pits could be utilized as additional storage by constructing embankments and seepage walls to contain additional flood waters pumped in from adjacent canals such as Mud Creek Canal, Snapper Creek Extension Canal, etc.</p> <p>Central Lake Belt Storage Area (Figure 4-10) was identified by the SFWMD and USACE as a CERP project. This project includes a combined above and in-ground 5,200 acre reservoir. The initial purpose of this reservoir is for water supply but it could also be used for storage during the wet season. An STA is also proposed on the western side of the storage area. During storm events, water can be routed to the Central Lake Belt Storage Area, that will be kept at low levels during the wet season, and can be managed to include pre-storm drawdown. Following the storm event, water from the storage area can be routed through the STA to increase the water quality prior to discharge to WCA3 or Biscayne Bay. This can work in coordination with the current structures located along the Northwest Wellfield Canal, or additional structures can be considered along the Snapper Creek Extension Canal that runs parallel to the Turnpike. As mentioned in the CERP plan, this would require seepage barriers to prevent horizontal losses to the groundwater.</p>
B12	Canal Bank Elevation	Raising Comfort Canal Southfork embankments in problem areas	Consultant	C-5 Central (Upland)	C5_2.1	<p>Raising canal levees will help reduce overtopping of embankments from the canals to the overland elevations during the peak of the storm events. For the C5 Watershed, the entire Comfort Canal Southfork has low embankments where there are residential units. Figure 5-3 shows the low embankments for the comfort canal for all locations with the canal stage profile for the 25-year/72-hour storm.</p> <p>Analysis has shown that while the low embankments present an immediate threat to the neighboring streets and houses during a high-intensity storm, the proximity to the canal also provides faster drainage and a quick retreat of water levels after the storm has passed. Therefore, to retain this drainage capacity, while</p>

ID	Type	Project Name	Status	Sub-Basin	Mitigation Strategy ID	Comment
						<p>providing protection against higher canal stages, the canal embankments must be raised in coordination with adding municipal pumps to the areas that would be lower than the canal stages, and therefore could not gravity drain.</p> <p>Additionally, increases to the peak stages are mainly due to tidal influence with +2 and +3 ft of SLR, and improvements to the tidal control structure S25 may decrease stages in the canal by reducing overtopping and backflow into the watershed from tide. This means that the minimum design height of the canal embankments should be re-evaluated under future conditions with the improvements to S25 implemented.</p>
B13	New Structure (Culvert)	Improvements to S-25A to allow inter-basin connection with C-4 Canal (Box Culvert Structure)	Consultant	C-5 Western (Rock Mines)	C5_3.1	<p>Currently, the S25A structure is kept closed during the wet season, and is opened in the dry season when water levels in Comfort Canal recede, in an effort to control salinity. The structure is a single-barreled, manually operated, gated culvert located at NW 45th Ave, as shown in Figure 5-5.</p> <p>Analysis has shown that the effects of pumping into the C4 Impoundment can have far-reaching impacts throughout the system. Flows have been shown to reverse direction from the C2 Watershed at Snapper Creek and SW 132nd Ave, as well as in the C3W Watershed at the connection between the C4 Canal and Coral Gables Canal. This effect on the system may increase with additional stormwater storage capabilities that may be implemented in the future in both the C4 and C2 Watersheds, for example expanding the C4 Impoundment.</p> <p>Allowing the connection with the C5 Watershed to open under certain conditions may alleviate some of the higher stages in the canal that are impacting the low-lying basins. This project would require the creation of a new gated structure with remotely-operable gates and a larger flow capacity. Alternatively, uni-directional flap gates can be utilized to reduce operational procedures and keep the flow direction out of the C5 Watershed.</p>

ID	Type	Project Name	Status	Sub-Basin	Mitigation Strategy ID	Comment
B14	Levee/Flood Barrier	Measures at the mouth of Miami River (Floodwalls, sector gate)	Consultant	C-6 East	C6_1.2A	<p>The Miami-Dade Back Bay Coastal Storm Risk Management Feasibility Study (Back Bay Study) was conducted by the USACE to examine the impacts of and potential responses to storm surge damage in Miami-Dade County. From this study, a surge barrier, floodwalls, riprap, and a pump station were recommended for the Miami River (C6 Canal). The report states:</p> <p>The current alignment of the floodwall begins on SW 15th Rd near the intersection of Brickell Ave. and continues east towards Biscayne Bay. The transition to the Biscayne Bay occurs and turns north and continues along the shoreline to the mouth of the Miami River. Crossing the Miami River is where a proposed Sector Gate and possibly a Miter Gate will be configured to allow boat traffic. The wall continues north on land entering on Biscayne Blvd. The floodwall will follow Biscayne Blvd primarily on the east side to 13th St. where the floodwall will turn left and end at NE 2nd Ave. For the Tentatively Selected Plan, a pump station location either integrated with the Sector Gate or located off Brickell Ave. behind the First Presbyterian Church in the parking lot (USACE, 2020).</p> <p>A sector gate was considered for crossing the mouth of the Miami River because of the relatively easy and fast ability to open and close the gate, as well as its ability to span large widths and remain partially open for extended periods of time if needed. Based upon the navigable channel width of 150 ft, a 150 ft wide sector gate was examined as an option to cross the channel, as part of the Back Bay Study. The top of gate height was preliminarily estimated to be at Elevation 20.9 ft NAVD88 and the bottom of the gate foundation at -18.6 ft NAVD88. These elevations were selected in consideration of equipment systems requirements and potential scour or accretion. The main disadvantages of the sector gate are the large footprint of the structure itself, especially with the highly urbanized coast at the mouth of the Miami Canal, and the increased cost of construction.</p>

ID	Type	Project Name	Status	Sub-Basin	Mitigation Strategy ID	Comment
B15	Pumps	Measures at the mouth of Miami River (Pumps)	Consultant		C6_1.2B	<p>The Miami-Dade Back Bay Coastal Storm Risk Management Feasibility Study (Back Bay Study) was conducted by the USACE to examine the impacts of and potential responses to storm surge damage in Miami-Dade County. From this study, a surge barrier, floodwalls, riprap, and a pump station were recommended for the Miami River (C6 Canal). The report states:</p> <p>The current alignment of the floodwall begins on SW 15th Rd near the intersection of Brickell Ave. and continues east towards Biscayne Bay. The transition to the Biscayne Bay occurs and turns north and continues along the shoreline to the mouth of the Miami River. Crossing the Miami River is where a proposed Sector Gate and possibly a Miter Gate will be configured to allow boat traffic. The wall continues north on land entering on Biscayne Blvd. The floodwall will follow Biscayne Blvd primarily on the east side to 13th St. where the floodwall will turn left and end at NE 2nd Ave. For the Tentatively Selected Plan, a pump station location either integrated with the Sector Gate or located off Brickell Ave. behind the First Presbyterian Church in the parking lot (USACE, 2020).</p> <p>A sector gate was considered for crossing the mouth of the Miami River because of the relatively easy and fast ability to open and close the gate, as well as its ability to span large widths and remain partially open for extended periods of time if needed. Based upon the navigable channel width of 150 ft, a 150 ft wide sector gate was examined as an option to cross the channel, as part of the Back Bay Study. The top of gate height was preliminarily estimated to be at Elevation 20.9 ft NAVD88 and the bottom of the gate foundation at -18.6 ft NAVD88. These elevations were selected in consideration of equipment systems requirements and potential scour or accretion. The main disadvantages of the sector gate are the large footprint of the structure itself, especially with the highly urbanized coast at the mouth of the Miami Canal, and the increased cost of construction.</p>

ID	Type	Project Name	Status	Sub-Basin	Mitigation Strategy ID	Comment
B16	Canal Bank Elevation	Raising canal embankments in problem areas (Primary and Secondary)	Consultant	C-6 Central (Upland)	C6_2.1	<p>Raising canal levees will help reduce overtopping of embankments from the canals to the overland elevations during the peak of the storm events. For the C6 Watershed there are several locations where raising the embankments can provide immediate relief during extreme rainfall and surge events with high canal stages. To review the deficiency of these embankment heights, a comparison was made with the 2022 Miami-Dade County Flood Criteria map, which is based on a 10-year, 24-hour storm event, 2060 scenario with SLR. Figure 6-3 shows the difference of the modeled embankment elevations minus the Miami-Dade Flood Criteria (MDFC) map elevations. In the figure, embankment elevations that are less than a foot above the MDFC are colored with greens and blues, and therefore less urgent in their potential upgrades. Reds and oranges are more urgent, as these embankment locations are much lower than the MDFC. The following areas may benefit from embankment improvements:</p> <ol style="list-style-type: none"> 1. C6 Canal (Miami Canal) <ol style="list-style-type: none"> a. Low sections in Hialeah Gardens b. Low sections at W 21st St (or 934) c. Low sections on south side of canal near East Dr d. Low sections near S26 structure 2. NW 97th Ave Canal and extension – full canal 3. NW 87th Ave Canal – full canal 4. NW 58th St Canal – full canal 5. Dressels Dairy Canal West – canal east of the Doral Park Country Club 6. Dressels Dairy Canal – full canal 7. Northline Canal – full canal 8. Melrose Canal – full canal (Embankments within the golf course should remain low for additional floodplain storage)
B17	Canal Improvements (New Canal, Extension, Widening, Realignment)	Widen C-6 canal to improve conveyance capacity	Consultant		C6_2.2	<p>As discussed in Section 6.1.1, the peak flow at S26 for all current and future conditions falls significantly under the design discharge of 3,470 cfs. This correlates with Canal Conveyance Capacity Project – C6 Canal Study (C6 Report) which found that the design flows could not be conveyed through S26 while satisfying the water surface elevation criteria set by the original C&SF project (SFWMD, 2020). According to the C6 Report, the original</p>

ID	Type	Project Name	Status	Sub-Basin	Mitigation Strategy ID	Comment
						<p>design of the C6 Canal was not implemented completely, and continued urbanization now limits the scope of further implementation of the original plan, limiting the ability to discharge the design flow through S26. In the C6 Report, the District evaluated the current canal performance under current design storm conditions and similar to the results seen in the FPLOS effort, they observed that the C6 Canal could not pass the original design discharge and that water surface elevation design standards were violated at several locations for the 25-year storm. An additional hypothetical scenario was explored that found that increasing canal cross sections in the undeveloped area upstream in the C6 Canal helped decrease water surface elevations to meet the design guidelines. Additional investigation is needed to assess the improvement in canal capacity and bank overtopping with modifications to target channel cross sections.</p>
B18	Distributed Storage	Temporary Storage in parks/golf courses	Consultant		C6_2.4	<p>To provide additional storage within the watersheds, Miami-Dade County parks or golf courses can potentially be used as emergency temporary storage. A majority of these parks are at lower elevations. Green infrastructure can be implemented at these parks to allow for recreational use during dry periods while also being able to provide storage during storm events. The C6 Watershed has many non-urban areas and recreational areas that may be considered for use as temporary storage areas during extreme rainfall events. A map of the Miami-Dade County Parks, municipal parks, and golf courses are provided for the C6 watersheds in Figure 6-4.</p> <p>Golf courses that are in-line with the secondary canals may already have naturally lower embankments or may require embankment degradation to promote overbank spilling in controlled areas.</p> <ol style="list-style-type: none"> 4. Doral Park Country Club – greens along the Dressels Dairy West Canal 5. Doral Golf Course – greens do not align with the canal, but the canal could be routed through the golf course or released during storm events into the lakes 6. Miami Springs Golf Course – greens are along the Melrose Canal and would require degradation in some

ID	Type	Project Name	Status	Sub-Basin	Mitigation Strategy ID	Comment
						<p>locations</p> <p>Parks can also be used for temporary floodplain storage during large storm events by degrading the canal embankments and creating what is essentially a dry detention area connected to the canal.</p> <p>7. Doral Central Park – not adjacent to a canal, but could be used for overflow (potentially in connection to the Northline Canal through the Southern Command field)</p> <p>8. Miami Springs Dog Park and fields at Miami Springs Senior High School – adjacent to C6 Canal</p> <p>9. Springview Elementary School fields - adjacent to FEC Canal</p> <p>In either strategy, topography in these golf courses or parks must be reviewed to ensure that new connections to the canal floodplain do not create new paths to structures or residences nearby.</p> <p>Additional natural areas in this watershed include the cow pasture and agricultural area in the southwest corner of NW 41st St and NW 107th Ave in Doral, which remains largely undeveloped and is naturally low-lying, and the Hialeah Park Casino located at Palm Ave and E 21st St. The Hialeah Park about 200 acres and is elevated several feet above the surrounding neighborhood to the west, as shown in the topographic profile in Figure 6-5. These higher elevation areas are largely natural parks and paved parking lots. The potential for this parcel could be to provide controlled storage using the naturally high landscape as levees, or to simply degrade the natural areas to provide additional floodplain storage during high rainfall events.</p>
B19	Storage areas	Acquire storage areas in western mining lakes (North Lake Belt Storage Area) with conveyance structures connecting to C-6 Canal	Consultant	C-6 Western (Rock Mines)	C6_3.1	<p>An option to provide more storage in the C6 Basin is to connect the mining pits west of the Turnpike and south of the C6 Canal to the C6 Canal. This project was identified by the SFWMD and USACE as a CERP project, referred to as the North Lake Belt Storage Area (Figure 4-10). This project includes a combined above and in-ground 4,500 acre reservoir. The initial purpose of this reservoir is for water supply but can be used for storage during the wet season. An STA is also proposed on the northern side of the storage area. During storm events, water can be routed to the North Lake Belt Storage Area, that will</p>

ID	Type	Project Name	Status	Sub-Basin	Mitigation Strategy ID	Comment
						be kept at low levels during the wet season, and can be managed to include pre-storm drawdown. Following the storm event, water from the storage area can be routed through the STA to increase the water quality prior to discharge to WCA3 or Biscayne Bay. Additional structures can be added to the C6 Canal to provide operational flexibility.
C1	Canal Bank Elevation	Improvements in Primary Canals C-1W and C-1 (canal bank elevation)	Consultant	Watershed C-1	SMD_2.1A	<p>The improvements in Primary Canals C-1W and C-1 may include maintenance and dredging to provide an even bottom gradient from the west to the east and an upgrade of canal bank top elevations to eliminate overtopping.</p> <p>The canal profiles show exceedance of canal banks on multiple locations for design events with a return period greater than 5-yr and 10-yr and an increase of SLR. In addition, the report shows that there is a water divide in canal C-1W at approximate chainage 5.5 which suggests that the cross sections of the C-1W may require widening to allow flow to the west (to canal L-31N). Structure S-338 closes depending on the flooding conditions downstream in the C-1 basin. Opening of the structure may cause additional flooding. Any changes for flood operations to this structure will be dependent on downstream flood conditions, therefore additional analysis is recommended to provide a better understanding of effects of redirecting flow to the west.</p> <p>Improvements in Canals C-1W and C-1 will involve:</p> <ul style="list-style-type: none"> • Increase of canal bank elevation above the stage of the 25-yr 3-day design event within the Urban Development Boundary and at locations where flooding damages may occur as result of overtopping of the canal banks.
C2	Dredging	Improvements in Primary Canals C-1W and C-1 (dredging)	Consultant		SMD_2.1B	<p>The improvements in Primary Canals C-1W and C-1 may include maintenance and dredging to provide an even bottom gradient from the west to the east and an upgrade of canal bank top elevations to eliminate overtopping.</p> <p>Improvements in Canals C-1W and C-1 will involve:</p> <ul style="list-style-type: none"> • Maintenance of canals C-1W and C-1, and potential dredging to improve the canal bottom gradient and

ID	Type	Project Name	Status	Sub-Basin	Mitigation Strategy ID	Comment
						<p>minimize hydraulic losses</p> <p>Considering that dredging and changing the elevations of the original canal bottom profiles could be prohibitively expensive for the entire canal, additional hydrographic surveys of the C-1N and C-1 canals and cross sections are recommended (C-1W canal already has a detailed cross section survey which has been implemented in the model). The new hydrographic surveys will be used to update the model cross sections, and additional simulation are suggested to determine locations where the canal bottom profile or cross section configurations may cause head losses due to constriction or sedimentation and determine canal sections that may require deepening or widening.</p>
C3	New Structure (Spillway)	New tidal structure (<u>combination of pump and spillway</u>) at the Goulds Canal outfall to Biscayne Bay	Consultant		SMD_2.3	<p>Additional consideration should be given to future urbanization of the agricultural areas which are in the vicinity of Goulds Canal. Future land use which is marked as Agriculture.</p> <p>If the agricultural areas become developed, significant runoff contribution will be expected into Goulds Canal, which may additionally require a tidal structure to accommodate discharges from urbanized areas.</p>
C4	Levee/Flood Barrier	Improvements to elevation requirements of levees at the eastern boundary of the C-1 watershed (L-31E)	Consultant		SMD_2.7	<p>Levee overtopping caused by storm surge can result in significant backflow in the C-1 watershed and increased upstream flood potential. Therefore, raising the top of the levees up to the 25-yr 3-day design event storm elevation at locations on the C-1 Watershed Canal within the Urban Development Boundary would be necessary. Elevation improvements of all levees at the eastern boundary of the C-1 watershed to 7.5 ft (NAVD 88) plus the necessary freeboard would be required. For example, near Goulds Canal, the levee will require an upgrade with a recommended top of the levee of 7.5 ft. (NAVD 88) plus required freeboard (based on the peak stages for the 100-yr event and +3 ft SLR).</p>
C5	Canal Bank Elevation	Improvements in Primary Canals C-100B	Consultant	Watershed C-100	SMD_3.1A	<p>Increase of C-100B canal bank elevation above the peak stage of the 25-yr 3-day design event within the Urban Development Boundary and at locations where flooding damages may occur as result of overtopping of the canal banks.</p>

ID	Type	Project Name	Status	Sub-Basin	Mitigation Strategy ID	Comment
C6	Dredging	Dredging/Maintenance of Canals C-100A, C-100	Consultant		SMD_3.1B	Maintenance and dredging of canals C-100A and C-100B for selected locations to improve the canal bottom gradient at locations which potentially have negative bottom gradient or higher hydraulic losses than average
C7	Canal Bank Elevation	Improvements in Primary Canals C-102 and C-102N (Increase canal bank elevation)	Consultant	Watershed C-102	SMD_4.1A	Improvements in Primary Canals C-102 and C-102N may require maintenance and dredging to provide an even bottom gradient from west to east and an increase of canal bank elevations to eliminate overtopping. Considering that changing the original canal bottom profile design could be prohibitively expensive for the entire canal, additional hydrographic surveys of the cross sections are recommended. The hydrographic surveys can be used to update the model cross sections, and additional simulations are suggested to determine locations where canal bottom profile may cause head losses due to constriction or sedimentation. Improvements in Canals C-102 and C-102N involve: <ul style="list-style-type: none"> • Increase of canal bank elevation above the stage of the 25-yr 3-day design event within the Urban Development Boundary and at locations where flooding damages may occur as a result of overtopping of the canal banks.
C8	Dredging	Dredging/Maintenance Canals C-102 and C-102N	Consultant		SMD_4.1B	Improvements in Canals C-102 and C-102N also involve: <ul style="list-style-type: none"> *Maintenance of Canals C-102 and C-102N to ensure a consistent canal bottom gradient which will minimize the hydraulic losses.
C9	Levee/Flood Barrier	Retrofitting Levees (Extension between S-20G and S-21A)	Consultant		SMD_4.5	The top elevation of the L-31E levee between Structures S20G and S21A. The profile shows that the levee elevation can be overtopped at multiple locations for peak stages greater than 5.5-6.0 ft. Overtopping of Levee L-31E can result in significant backflow in the C-102 watershed, increased flooding potential upstream and considerably slower drainage of the flooded areas. Therefore, upgrading the levee to 7.5 ft NAVD plus required freeboard is recommended (7.5 ft NAVD is based on the headwater peak stages for the 100-yr design event and SLR +3.0 ft).
C10	Canal Bank Elevation	Improvements in Primary Canals C-103 and C-103N (Increase canal bank elevation)	Consultant	Watershed C-103	SMD_5.1A	The improvements in Primary Canals C-103 and C-103N considers improved maintenance and dredging at locations with high head losses to provide an even bottom gradient from west to east, and upgrades of the canal banks to eliminate overtopping. <ul style="list-style-type: none"> • An increase of C-103 canal bank elevation above the

ID	Type	Project Name	Status	Sub-Basin	Mitigation Strategy ID	Comment
						stage of the 25-yr 3-day design event, within the Urban Development Boundary and at locations where flooding damages may occur as a result of overtopping of the canal banks.
C11	Dredging	Dredging/Maintenance Canals C-103 and C-103N	Consultant		SMD_5.1B	In addition to the previous recommendation: <ul style="list-style-type: none"> • Maintenance of canals C-103 and C-103N to ensure consistent canal bottom gradient which will minimize the hydraulic losses. • An example of the canal profiles is provided in the FPLOS report Considering that dredging of the original canal bottom profile design could be prohibitively expensive for the entire canal, additional hydrographic surveys of the cross sections are recommended. The hydrographic surveys can be used to update the model cross sections, and additional simulation are suggested to determine locations where the canal bottom profile may cause head losses due to constriction or sedimentation
C12	Levee/Flood Barrier	Retrofitting Levees (Extension between S-20G and Florida City Canal)	Consultant		SMD_5.5	Overtopping of the levee can result in significant backflow in the C-103 watershed which will also result in considerably slower drainage and increased upstream flood potential. Therefore, upgrading the levee to 7.5 ft NAVD plus required freeboard are recommended. The top elevation of the L-31E levee between structure S20G and Florida City Canal. The profile shows that the levee elevation can be overtopped at multiple locations for peak stages greater than 5.0-6.0 ft.
D1	Canal Bank Elevation	L-31N Retrofitting and increase canal bank elevation (eastern canal bank)	Consultant	L-31NS	C111_1.1	Retrofitting and increasing the eastern canal bank elevation of L-31NS can provide significant reduction of flood extent and duration within the agricultural areas of the watershed and increase of the FPLOS rating to greater than the watershed 5-yr rating. While the SLR does not significantly increase the flood extent, the flood duration increased with SLR and rainfall return period.
D2	Pumps	New Pump at S-176	Consultant		C111_1.2	Installation of forward pump at structure S176 is recommended for additional analysis to increase the drainage capacity of this section of canal L-31N to compensate for the reduced hydraulic gradient between S176 and the outfall of canal C-111 for the conditions of SLR3.

ID	Type	Project Name	Status	Sub-Basin	Mitigation Strategy ID	Comment
D3	Canal Bank Elevation	C-111 Ag Retrofitting and increase canal bank elevation	Consultant	C-111 AG	C111_2.1	Retrofitting and increasing the low elevations of the eastern canal bank elevation of C-111 Ag can provide significant reduction of flood extent and duration within the agricultural areas of the watershed and increase of the FPLOS rating to greater than the current watershed 5-yr rating.
D4	Pumps	New Pump at S-177, S-178 and S-18C	Consultant		C111_2.2	Installation of forward pump at structure S177 is recommended for additional analysis to increase the drainage capacity of this section of canal C-111 in order to compensate for the reduced hydraulic gradient between S177 and the outfall of canal C-111 for the conditions of SLR3. Analysis will be provided for simultaneous pump operation at structures S176 and S177.
D5	Levee/Flood Barrier	Extension of Levee L-31E Southwest (Card Sound Rd and L-31E to S-197, approx 4miles)	Consultant	US1 Watershed	C111_3.1A	<p>The US1 Watershed has been assigned a no FPLOS rating considering that the watershed is unprotected from the south and there are no agricultural areas, and the urban areas small fraction (35 acres from total of 16,803 acres, mostly located on high ground). However, during storm surge, watershed US 1 is unprotected from the coast and the storm surge propagates considerably north thus creating potential flooding of Card Sound Road. Therefore, a potential extension of Levee L-31E from the junction with Card Sound Road to the boundary between watershed US 1 and C-111 South is recommended for analysis to determine protection from storm surge events and overtopping during high tide for future conditions of SLR</p> <p>Watershed US 1 discharges into Barnes Sound which is part of Florida Bay. Florida Bay is a large shallow estuary located on the southern tip of the Florida mainland, between the Florida Keys and the mainland. Barnes Sound is one of the interconnected bodies of water within Florida Bay, situated on the northeastern side of the bay. It is known for its diverse marine ecosystems and serves as a habitat for various marine species. Therefore, installing a levee which may interfere with the outflows to Barnes Sound.</p> <p>In the current conditions, the outflows to Barnes Sound</p>

ID	Type	Project Name	Status	Sub-Basin	Mitigation Strategy ID	Comment
						<p>play a vital role in sustaining the ecosystem and supporting life within the area. These outflows bring essential freshwater, nutrients, and sediments that contribute to the health and diversity of the ecosystem. However, with projected sea level rise (SLR) in the future, the availability of fresh outflows may become limited, posing challenges for the long-term sustainability of the ecosystem.</p> <p>To address this issue and ensure the continued ecological functioning of the area while protecting against the impacts of SLR, installing a levee with culverts and backflow prevention measures can provide an effective solution. By incorporating culverts, which are pipes or channels that allow water to pass through, it is possible to maintain the essential outflow of freshwater while preventing saltwater intrusion.</p>
D6	Levee/Flood Barrier	Upgrades and retrofitting of Levee L-31E	Consultant	MODEL LAND Watershed	C111_4.1	The watershed is surrounded by levees, with a small fraction of agriculture (205 out of 18,390 acres), and urban areas (52 acres from total of 18,390 acres, mostly located on higher ground). Upgrades and retrofitting of Levee L-31E are recommended to prevent overtopping of the levee and long retention times of flooded areas.

APPENDIX B WATER SUPPLY VULNERABILITY ASSESSMENT APPROACH

South Florida Water Management District

Water Supply Vulnerability Assessment Approach

Planning Assumptions and Scenario Recommendations for the Lower East
Coast Region



Contributors

Yitzy Rosenberg, District Resiliency	Alicia Magloire, Water Supply
Carolina Maran, District Resiliency	Anushi Obeysekera, Water Supply
Mark Elsner, Water Supply	Simon Sunderland, Water Use
Pete Kwiatkowski, Water Supply	Walter Wilcox, Hydrology & Hydraulics
Tom Colios, Water Supply	Jenifer Barnes, Hydrology & Hydraulics
Kris Esterson, Water Supply	Savanah Middlebush, Office of Counsel

Abbreviations

AFSIRS	Agricultural Field Scale Irrigation Requirements Simulation
AG	Agricultural (Demand)
ASR	Aquifer Storage and Recovery
BEBR	Bureau of Economic and Business Research
C&SF	Central and Southern Florida
CERP	Comprehensive Everglades Restoration Plan
DSS	Domestic Self Supply (Demand)
ECFM	East Coast Floridan Aquifer System Model
ECSM	East Coast Surficial Groundwater Model
ET	Evapotranspiration
FDACS	Florida Department of Agriculture and Consumer Service
FEB	Flow Equalization Basin
FIU	Florida International University
FPLOS	Flood Protection Level of Service
FSAID	Florida Statewide Agricultural Irrigation Demand
GCM	Global Circulation Model
GW	Groundwater
ICI	Institutional, Commercial, and Industrial (Demand)
LEC	Lower East Coast
LOSOM	Lake Okeechobee System Operating Manual
MGD	Million Gallons per Day
NOAA	National Oceanic and Atmospheric Administration
PCUR	Per-Capita Use Rate
PWR	Power (Demand)
PWS	Public Water Supply (Demand)
RAA	Regional Allocation Areas
REC	Recreation and Landscape (Demand)
RSM	Regional Simulation Model
SFWMM	South Florida Water Management Model
SLR	Sea Level Rise
STA	Stormwater Treatment Areas
SW	Surface Water
SWM	Surface Water Management
TAZ	Traffic Analysis Zones

USGS	United States Geological Survey
WCA	Water Conservation Area
WSP	Water Supply Plan

Contents

Executive Summary	1
Introduction and Background	2
Global and Local Context	2
The Need for an Assessment	3
Internal Workgroup	4
Water Use Category Growth and Withdrawal Rates.....	6
Public Supply Demand	6
Agricultural Demand	6
Landscape and Recreational Demand	7
Institutional, Commercial, and Industrial and Power Demands	7
Domestic Self Supply Demands	8
Future Climate Conditions	9
50-year Time Horizon	9
Sea Level Rise	9
Temperature, Rainfall and Evapotranspiration	11
Water Availability	13
System Overview	13
Models	16
Defining and Measuring Vulnerability	17
Availability Sources	18
Scenario Formulation.....	26
Expected Outcomes	28
Scenario Limitations and Timeline.....	28
Future Work	29
Future Scenarios	29
Not Assessed Availability Sources	31
Appendix A: Water Use Category Growth and Withdrawal Rates Workgroup Discussion	32
A.1: Water Use Category Growth Rates	32
A.2: Water Demands and Withdrawal Rates	39

Table of Figures

Figure 1. WSWA overall approach to incorporating climate change variable and future conditions	5
Figure 2. 2017 and 2022 Intermediate Low and High NOAA Sea Level Rise Projections for Key West.	10
Figure 3. Example tidal observational dataset offset for future SLR.	11
Figure 4. Summary of the adopted approach to modeling future climate scenarios.....	12
Figure 5. Time Series of gridded average tasmax for all climate models in the LOCA dataset, (b) Kernel Density Functions of tasmax for base and future periods.	12
Figure 6. Time Series of gridded average rainfall for all climate models in the LOCA dataset. Also shown is the SFWMM (2x2) average rainfall and smoothed PRCPTOT for each model.....	13
Figure 7. SFWMM Block Diagram.	13
Figure 8. System Vulnerability Block Diagram Legend.	14
Figure 9. Vulnerability Block Diagram highlighting climate influences, supply sources, and demand.	15
Figure 10. IDEF0 diagram legend for water availability sources.	17
Figure 11. Shallow Impoundment IDEF0 Diagram.	19
Figure 12. Unsaturated Zone IDEF0 Diagram.	20
Figure 13. Canals IDEF0 Diagram.	21
Figure 14. Lakes IDEF0 Diagram.	22
Figure 15. Reservoirs IDEF0 Diagram.	23
Figure 16. Surficial Aquifer IDEF0 Diagram.....	24
Figure 17. Diagram of the availability metrics and assumptions.....	25
Figure 18. Current climate scenario diagram.	27
Figure 19. SLR1, Climate Change 1, Less Conservative, and More Conservative scenario diagram.	27
Figure 20. Example assessment output comparing a theoretical source volume and demand for model runs A, E, and F.	28
Figure 21. Mitigation scenarios runs.	30
Figure 22. Example mitigation scenario output highlighting the effect of new supply sources.....	31
Figure 23. Public Supply growth rate options.	32
Figure 24. Agricultural growth rate options.	34
Figure 25. Recreational growth rate options.	35
Figure 26. Landscape growth rate options.	35
Figure 27. Industrial, Commercial, and Institutional growth rates options.	36
Figure 28. Power Generation growth options.	37
Figure 29. Domestic Self Supply growth options.....	38
Figure 30. Public Supply withdrawal rate options.	39
Figure 31. Agricultural demand options.	42
Figure 32. AFSIRS parameters and data sources.	43
Figure 33. Illustration of parameters reflected in AFSIRS.	43
Figure 34. Landscape and Recreation demand options.	45
Figure 35. Industrial, Commercial, and Institutional demand options.....	46
Figure 36. Power withdrawal rate options.	47
Figure 37. Domestic Self Supply withdrawal rate options.....	47

Executive Summary

The South Florida Water Management District (SFWMD or District) is conducting a Water Supply Vulnerability Assessment (WSVA) aimed at understanding how future development and climate conditions impact our regional water supply. SFWMD is developing a density-dependent groundwater model – the East Coast Surficial Model (ECSM) – which will initially be run with Sea Level Rise (SLR) scenarios. Additionally, SFWMD is developing future conditions rainfall, evapotranspiration (ET), and temperature datasets to support climate change scenario formulation for follow up ECSM simulations and other regional modeling.

The District created an internal workgroup with representation from various organizational units to develop an approach for identifying and assessing vulnerabilities. Initial scenarios, modeling assumptions, input data selection and limitations, scope, time, and cost were considered in the development of the proposed approach. Table 1 summarizes the majority of the initial recommendations and assumptions that are being integrated into the proposed approach.

To properly analyze the effects of climate change, including SLR, water demand and climate projections will be estimated, and each of the water availability sources will be analyzed as independent “buckets”, using selected metrics to assess vulnerability. Initial scenario formulation includes less and more conservative estimate ranges, with degrees of warming, dryness, and sea level rise, along with 2045 and 2075 growth scenario ranges. The outputs of these scenario runs should allow for SFWMD to understand how future conditions may impact overall water resources availability. Future iterations beyond this WSVA may include the analysis of adaptation strategies and their effects.

The WSVA will be build on the 2023 Lower East Coast Water Supply Plan (WSP) update, and other upcoming WSP efforts. Scenario runs A through C are planned to be included in the 2023 LEC Plan Update while the other scenario runs will be conducted after the 2023 LEC Plan Update as part of the WSVA. The assessment will be based on WSP methodologies by independently analyzing the effects of future climate conditions on growth rates, withdrawal rates, and availability of water supply sources. Public supply and domestic self-supply’s 20-year BEBR growth rates will be extrapolated to 50 years and their withdrawal rates will be calculated using the WSP per capita use rate. Agriculture, landscape, and recreational withdrawal rates will include projected temperature, rainfall, and ET rates at 50 years in the

Table 1. Summary of recommendations in the report.

WS Vulnerability Assessment Future Conditions Recommendations		
Water Demand Projections		
Water Use Category	Growth Rate	Withdrawal Rate
Public Supply	Extrapolate BEBR Med growth to 2075	PCUR at 50 years
Agriculture	LEC WSP 2045 Rate	AFSIRS with Climate Change Datasets
Landscape and Recreation	Proportional to Population Growth	Use rate at 50 years
Domestic Self Supply	Proportional to Population Growth	PCUR at 50 years
Institutional, Commercial, and Industrial	LEC 2045 WSP Rate	LEC 2045 WSP Rate
Power	LEC 2045 WSP Rate	LEC 2045 WSP Rate
Climate Projections		
Climate Conditions	Rainfall, Temperature, Evapotranspiration	Sea Level Rise
Datasets	Downscaled GCMs	2022 NOAA Inter Low, Inter High
Existing Availability Source Segmentation		
Availability Sources	Metrics	Assumptions
Surficial Aquifer	GW Levels, TDS, Flow Vectors, Zone Budgets	Canal Stages, Flows from RSM, Tidal
Shallow Impoundment	Storage, Water Depth, Overland Flow	
Unsaturated Zones	Storage	
Canals	Storage, Stages	Conveyance, Quality, Structure Operations
Lakes	Storage, Inflows/Stages	
Reservoirs	Storage	Seepage, Level of Service
Scenario Formulation		
Scenario Run	Growth Variable	Climate Variable
A (LEC WSP)	Base Condition	Current Climate
B (LEC WSP)	BEBR Med 2045	Current Climate
C (LEC WSP)	BEBR Med 2045	SLR1
D (WS Vuln)	BEBR Med 2045	Warmer and Drier
E (WS Vuln)	BEBR Med 2045	Warmer, Drier, & SLR1
F (WS Vuln)	BEBR Med 2045	Hot, Driest, & SLR2
G (WS Vuln)	BEBR Med 2075	Current Climate
H (WS Vuln)	BEBR Med 2075	SLR1
I (WS Vuln)	BEBR Med 2075	Warmer and Drier
J (WS Vuln)	BEBR Med 2075	Warmer, Drier, & SLR1
K (WS Vuln)	BEBR Med 2075	Hot, Driest, & SLR2

future. The ECSM will incorporate SLR as a boundary condition, and future temperature, rainfall, and ET conditions.

Water Supply Vulnerability Assessment Approach

Introduction and Background

The South Florida Water Management District (SFWMD or District) is conducting a Water Supply Vulnerability Assessment (WSVA) aimed at understanding how future development and climate change, including sea level rise, impact regional water supply, and how improvements to water management, water allocation rules, and to the regional system infrastructure can be prioritized to increase resilience.

The purpose of this report is to provide a summary of planning assumptions and scenario recommendations to serve as guidance to the WSVA implementation process for the LEC Planning Area, establishing an internally agreed upon approach, and assessment intention. The report is also intended to serve as a documented process for developing a vulnerability assessment that can be replicated in other planning regions and also by other agencies and stakeholders.

The report is structured into four main sections based on the proposed assessment approach: Water Use Category Growth and Withdrawal Rates, Future Climate Conditions, Availability Sources, and Scenario Formulation. The appendix contains additional details to support understanding of the thought process behind the summarized assumptions and recommendations.

Global and Local Context

Changing climate conditions impact water supply and demand across the region, at micro and macro scales. The District has incorporated qualitative summaries of the potential effects of climate change and future conditions on water supply as part of its Water Supply Plans (WSP) and other related initiatives to provide sustainable water supply for reasonable-beneficial water users while not causing harm to water resources and related natural systems. To improve upon these efforts, the District will be conducting a WSVA that will use advanced modeling to analyze the water supply vulnerability as a result of future climate conditions, including sea level rise (SLR) and increasing demands on those systems beyond the current WSP 20-year planning horizon.

The first WSVA will incorporate the SFWMD's Lower East Coast (LEC) water supply planning area, which includes Palm Beach, Broward and Miami-Dade counties and portions of Monroe, Collier, and Hendry counties.

The WSVA will look at how changes to temperature, rainfall, evapotranspiration (ET), SLR, and growth projections affect availability of various water sources for human uses while not harming water resources and related natural systems. The proposed assessment will help the District make informed decisions on its many water management responsibilities and support partner agencies in their planning needs.

South Florida's unique hydrogeologic, meteorological, and supply/demand system requires a dedicated vulnerability analysis to properly plan for future conditions. However, there are many interdependent complexities between management practices, stakeholder needs, and current and future physical conditions

that present challenges to the completion of a comprehensive vulnerability assessment. Therefore, as a preliminary approach, the proposed assessment is intentionally limited in scope and purpose to allow for future iterations based on lessons learned.

This is the first time that a dedicated South Florida water supply assessment will look at the combined effects of SLR, climate change variables and future growth in demands. Hence, there are no best practices or standardized procedures to rely upon. Additionally, due to the complexity and requirements of the models initially identified to conduct the proposed assessment, the criteria for success, as well as the modeling approach, were carefully considered in the assessment planning process. This report summarizes initial recommendations for the above-mentioned considerations and will serve as the basis for the concurrent assessment scoping. These considerations and recommendations are a result of eight months of internal workgroup discussions, with representation from Water Supply, Water Use, The Office of Counsel, Resiliency, and Hydrology & Hydraulics bureaus.

What follows is documentation on processes as well as the initial workgroup recommendations regarding approaches for assumptions for growth rates, withdrawal rates, climate variables, water availability, and model scenarios and plan for assessment execution.

The Need for an Assessment

Florida statutes requires that WSPs be based on at least a 20-year planning horizon and updated at least every five years. WSP provide a roadmap on how projected water demands can be met without causing harm to the water resources within the planning horizon. While 20-year planning periods serve as an adequate planning horizon to provide guidance to various water use studies, such as utility master planning, regional water resources development and natural resource protection studies, the 20-year planning horizon is not sufficient to evaluate the longer-term effects of climate change and SLR and anticipated potential adaptation and mitigation needs. WSPs consider climate change and SLR possible impacts, but are not formulated yet to adapt to the impacts of longer-term projected climate and growth.

The current WSP 5-year updates being developed by the District have a planning horizon of 2045. WSP, in general, base their emphasis and technical process on the paradigm of how water users can meet current and future demands for at least a 20 year planning horizon. For example, WSP use historic data and observations with 20-year demand projections in their scenarios. Consequentially, this categorizes availability of sources as entities to meet demands based on existing conditions rather than as systems with vulnerabilities that have evolving characteristics over longer time periods. As a result, there is a need for the development of an assessment outside of the WSP process that takes a dedicated look at each source's inherent vulnerabilities and understand the nature of and effects caused by each source's vulnerability characteristics as they change over longer time periods.

The proposed WSPA will look at the vulnerabilities inherent within each source as a function of its interactions with the hydrological system and using its features, demands, and climate parameters as inputs. This allows the District to assess vulnerability as an independent parameter, which can then be addressed through targeted adaptation and mitigation strategies that can increase the relevant source's resilience. Furthermore, the concept of water supply resiliency is best approached from a regional perspective, beyond the distinction of boundary lines -- either agency, permittees, or otherwise. The WSPA, like the WSPs, can provide an integrated systems perspective to vulnerability and resiliency.

Lastly, it's important to note that the assessment will be designed around usefulness for water supply planners, managers, and water users. For instance, given that infrastructure investments and their engineering designs are typically based on a 50-year lifespans as part of future planning efforts; a 50-year time horizon is being recommended.

Internal Workgroup

To incorporate input from the many organizational units within the Districts, an internal workgroup was created with representation from Resiliency, Water Supply, Water Use, Office of Counsel, and Hydrology & Hydraulics bureaus to develop the approach, decision variables, scope, and recommendations that will be used in the assessment. This group was selected and identified to ensure that all relevant business areas were represented, and their inputs were included in initial considerations for the proposed assessment. As part of these discussions, in-depth research was conducted, and the latest science and methodologies used by industry, academia, and similar agencies were presented. The workgroup met for a period of eight months to finalize its initial recommendations and discuss major assumptions.

The discussions were segmented into the following categories: Water Use Category Growth Rates and Withdrawal Rates, Climate Change Variables, and Sources of Water Availability. These categories were intentionally selected to match those referenced in the WSP to leverage existing modeling demands and assumptions and to serve as a supplement to the analysis conducted to support the WSP. However, these categories differ from the WSP in that they were discussed in relation to climate change. For instance, the workgroup discussed how the growth of Public Supply might be affected by climate change in a way that is not already captured using current WSP methodology.

Every additional changing variable introduces the need for further comparative model runs, which requires additional resources and scoping. Therefore, when possible and appropriate, the option of no change from WSP procedures was selected as the recommendation. It should be noted that all the variables discussed for this initial iteration of the WSPA are based on and applicable to the LEC planning area. Future iterations of a WSPA may necessitate different assumptions.

Figure 1 presents a schematic that highlights the overall approach taken by the District to incorporate climate change effects such as SLR and changing rainfall and ET patterns, and future growth conditions in the WSPA for the LEC planning area. The details of the discussions, the research presented, and the explanation for the recommendations that were made are documented below. The following sections are intentionally written as a documentation of the technical discussion process and initial proposed recommendations rather than conclusive suggestions. The process will adapt based on best available information and the knowledge gained as the WSPA progresses.

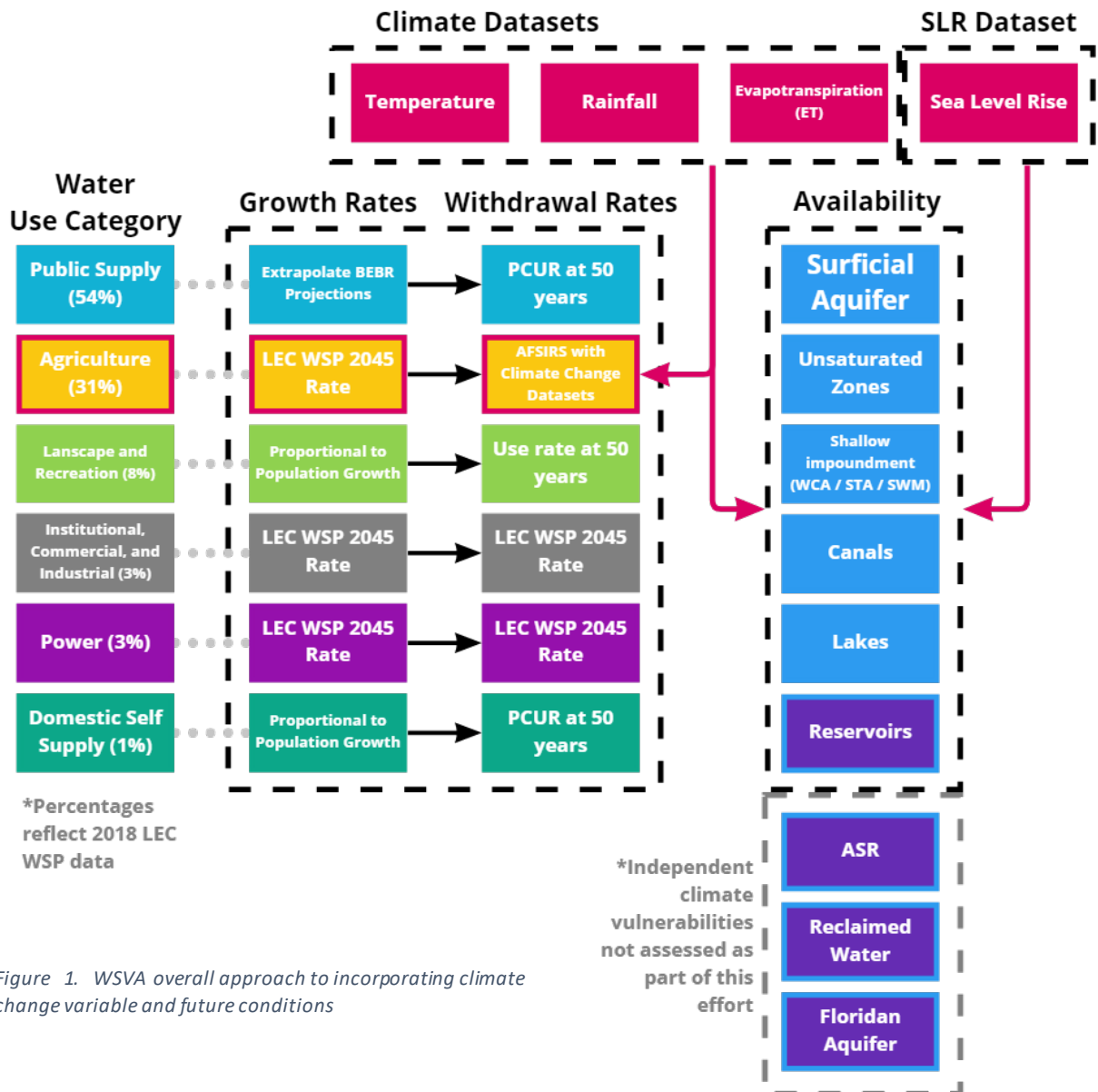

Figure 1. WSPA overall approach to incorporating climate change variable and future conditions

Water Use Category Growth and Withdrawal Rates

Projected water use demands are determined as a function of each water use category’s projected growth rate and their projected per unit withdrawal rates. The recommended approaches to project future growth and withdrawal rates for each of the water use categories - Public Supply, Agricultural, Landscape and Recreation, Institutional, Commercial, and Industrial, Power, and Domestic Self Supply – are summarized below. These water use categories, and overall proposed approach to estimate demands, leverage the methodology developed for the LEC WSP. See Appendix A: Water Use Category Growth and Withdrawal Rates for detailed workgroup discussion, relevant research, and major assumptions used in developing the approach for each water use category.

Public Supply Demand

Public Supply (PS) is defined as potable water supplied by water treatment plants with average gross (raw) pumpage of 0.10 million gallons per day (mgd) or greater. In the LEC, PS accounted for 49% of total demands in 2016, of which 94% came from fresh surface water and groundwater sources. In the LEC WSP, population growth and distribution is derived from multiple sources of information, including county-level data from the University of Florida Bureau of Economic and Business Research (BEER), sub-county data from traffic analysis zones, local data from local government comprehensive plans, and United States census data. This population is further divided into utility service area by using utility service area GIS coverages.

The PS withdrawal rate is calculated by applying a utility-specific per-capita use rate (PCUR), which is calculated in the LEC WSP by taking the monthly and yearly utility-specific finished water data reported to Florida Department of Environmental Protection (FDEP) and dividing it by the utility's estimated population (permanent residents) utility-served service area population. The most recent 5 years PCURs are averaged to develop an average utility-based PCUR, which is then applied to the utility-served population projections to calculate the projected demand at five-year increments for a 20-year planning horizon.

For the PS water demand estimation in the proposed WSPA, it is recommended that BEER's 20-year county level Medium projection be extrapolated out to 2075 to account for population growth, and that the PS withdrawal rate methodology adopted in the current WSP approach, as summarized above, is replicated for the 2075 estimated growth.

Agricultural Demand

Agricultural demand (AG) is defined in the LEC WSP as self-supplied water used for commercial crop irrigation, greenhouses, nurseries, livestock watering, pasture, and aquaculture. In the LEC, AG accounts for 37% of total demands in 2016 of which approximately 99% comes from sources considered in the proposed WSPA.

The WSP methodology for projecting agricultural growth is based on the irrigated agriculture growth maps generated by Florida Department of Agriculture and Consumer Services (FDACS) in the Florida Statewide Agricultural Irrigation Demand (FSAID) report. These reports are generated annually and contain parcel-level polygons of statewide agricultural lands (ALG) and agricultural irrigated lands (ILG) including crop type projected out to 25 years.

The AG water withdrawal rate is determined in the WSP using the Agricultural Field Scale Irrigation Requirements Simulation (AFSIRS) model (Smajstrla 1990). The FDACS irrigated crop acres, soil types, growing seasons, and irrigation methods are used as input data for the AFSIRS model. AG withdrawal rate estimates and projections are based on the typical commercially grown crop categories developed by the FDEP and water management districts for use in water supply plans. The demands of these crops are then calculated for an average rainfall year and a 1-in-10-year drought.

For the AG water demand estimation in the proposed WSPA, it is recommended that the AG growth rate adopts the current LEC WSP approach and utilizes the same estimated acreage. Although it is likely that these acreages will change as a result of climate change, there isn't an established process for projecting that change beyond the 25 years developed in FSAID. For the AG withdrawal rates, it is recommended that the AFSIRS approach adopted in the LEC WSP is applied with the simulation of future climate conditions.

Landscape and Recreational Demand

Landscape and Recreation demand (REC) is defined in the LEC WSP as self-supplied and reclaimed water used to irrigate golf courses, sports fields, parks, cemeteries, and large common areas such as land managed by homeowners' associations and commercial developments. In the LEC, REC accounts for 8% of total demands in 2016 of which approximately 71% comes from sources considered in the proposed WSVA assessment.

In the LEC WSP, growth in REC demands were increased proportionally with population growth. However, because golf is a unique use case that accounts for a significant portion of REC demand and is influenced by different parameters than other recreation and landscape uses, its growth is segmented from other REC demands and increases/decreases are done on a case-by-cases basis based on local best-available information.

While in the past REC withdrawal rates have been calculated using AFSIRS, the 2023 update to the LEC WSP will use water use data from the District's Estimated Annual Water Use Report. This methodology will likely follow a similar approach to PCUR developed for PS noted above.

For the REC water demand estimation in the proposed WSVP, it is recommended that the REC growth rate adopts the current LEC WSP approach and utilizes the same projected REC withdrawal rates.

Institutional, Commercial, and Industrial and Power Demands

Industrial, Commercial, and Institutional (ICI) demand is defined in the LEC WSP as self-supplied water associated with the production of goods or provision of services by industrial, commercial, or institutional establishments. In the LEC, ICI accounts for 3% of total demands in 2016 of which approximately 65% comes from sources evaluated in the proposed WSVA assessment.

Power Generation (PWR) demand is defined in the LEC WSP as self-supplied and reclaimed water used for cooling, potable, and process water by power generation facilities. In the LEC, PWR accounts for 2% of total demands in 2016 of which approximately 0% comes from sources considered in the proposed WSVA assessment (2018 LEC WSP). Power Generation facilities primarily use seawater, brackish groundwater, and reclaimed water to meet 100% of the demands.

ICI growth is captured on a case-by-case basis with the addition of known permits and population projections while PWR growth is captured exclusively on a case-by-case basis in consultation with power utilities, principally Florida Power and Light. Withdrawal rates are captured by WUP annual reports and not projected for WSPs.

For the ICI and PWR water demand estimation in the proposed WSVP, it is recommended that the ICI and PWR growth rate adopts the current LEC WSP approach and utilizes the same projected ICI and PWR withdrawal rates.

Domestic Self Supply Demands

Domestic Self Supply (DSS) demand is defined in the LEC WSP as potable water used by households served by small utilities (less than 0.10 mgd) or self-supplied by private household wells. In the LEC, DSS accounts for 1% of total demands in 2016 of which 100% comes from sources evaluated in the proposed assessment. It is assumed that approximately 50% of DSS wells are also used for irrigation. DSS projections are developed simultaneously with PS population estimates and projections and uses the same PCUR as PS.

For the DSS water demand estimation in the proposed WSVA, it is recommended that the DSS growth rate adopts the current LEC WSP approach and utilizes the same projected DSS withdrawal rates.

Future Climate Conditions

50-year Time Horizon

As stated above, the purpose of the WSPA is to understand how climate change may affect water supplies. The gradual nature of climate change makes it difficult to see its effects in the short term and at the same time it is in the short term that the most effective mitigation can take place. The proposed assessment is therefore looking beyond the typical 20-year planning horizon and modeling a water future that exists when the expected consequences will likely be felt and measurable. For this reason, the proposed WSPA will look at conditions in 50 years, or 30 years beyond that reviewed in the LEC WSP.

Similarly, adaptation and mitigation strategies that may be simulated as part of long-term modeling should not be evaluated beyond 50 years due to high levels of uncertainty. Infrastructure lifespans are usually 50 years and outputs of the model runs will be informative and helpful to infrastructure planners.

Furthermore, regional water supply projects, such as the C-51 reservoir, required permit applicants to submit 50-year demand estimates, which were required to financially justify the development of the reservoir.

Sea Level Rise

Sea Level Rise (SLR) will likely be one of the most critical effects of climate change on the region. While the effects of SLR on flooding are being studied as part of the District's Flood Protection Level of Service (FPLOS) program, the effects of SLR on water supply in South Florida have yet to be modeled and analyzed. To investigate these effects, the ECSM – a density-dependent groundwater model of the Surficial Aquifer System (SAS) is being developed, which will allow us to explicitly simulate saltwater movement, including that associated with SLR. The SLR projections will be included into the model application for the 50-year scenario.

There are many SLR projections based on different methodologies, data, and potential application. Section 380.093.(3).(d).3.b., F.S. associated with the Resilient Florida Program and the FDEP Sea Level Impact Projections (SLIP) assessments state, at a minimum, assessments should include the NOAA 2017 Intermediate High and Intermediate Low curves. In February 2022, NOAA published their latest update to the Sea Level Rise Scenario projections (NOAA Technical Report NOS 01), which is based on updated data and the latest methodologies. Table 2 and Figure 2 shows a comparison of the two projections, highlighting the 2022 projections lower ranges of uncertainty.

Table 2. The difference in the SLR projected height for Virginia Key, FL between NOAA 2017 and 2022 projections.

NOAA Curve/SLR (ft)	2017 (2040)	2022 (2040)	2017 (2060)	2022 (2060)	2017 (2080)	2022 (2080)
Intermediate Low	0.69	0.36	1.08	1.21	1.44	1.67
Intermediate	1.05	0.82	1.8	1.44	2.72	2.36
Intermediate High	1.41	0.92	2.56	1.87	4.1	3.38
High	1.77	1.02	3.38	2.3	5.61	4.46

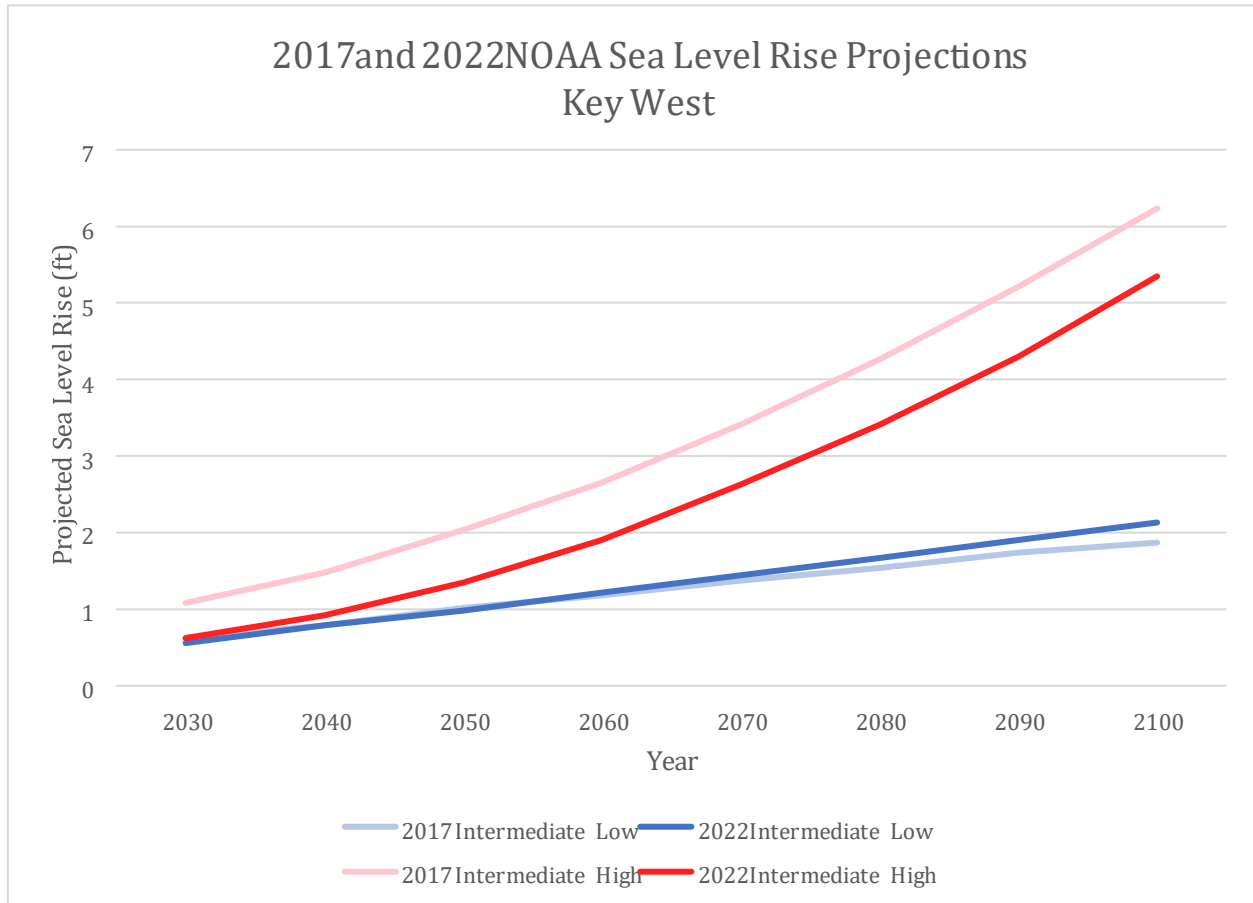

Figure 2. 2017 and 2022 Intermediate Low and High NOAA Sea Level Rise Projections for Key West.

Based on the updated 2022 NOAA projections, this vulnerability assessment will use the 2022 NOAA Intermediate Low and Intermediate High curves as the initial projected SLR scenario. The Florida Flood Hub, in coordination with FDEP Resilient Florida Program, is currently coordinating and leading a scientist workgroup in charge of proposing statewide SLR projections. To maintain approach consistency, the District will adopt Resilient Florida statewide recommendations, as applicable.

To incorporate SLR in the ECSM boundary conditions, a future conditions tidal dataset with daily maximum, minimum, and average elevations will be developed based on an observation dataset, offset per the selected 2022 NOAA curves. Figure 3 shows an example of how a tidal observation dataset may be offset to account for future SLR. The future conditions tidal dataset is currently under development and will undergo a thorough statistical analysis and review process before being incorporated into the WSVA modeling.

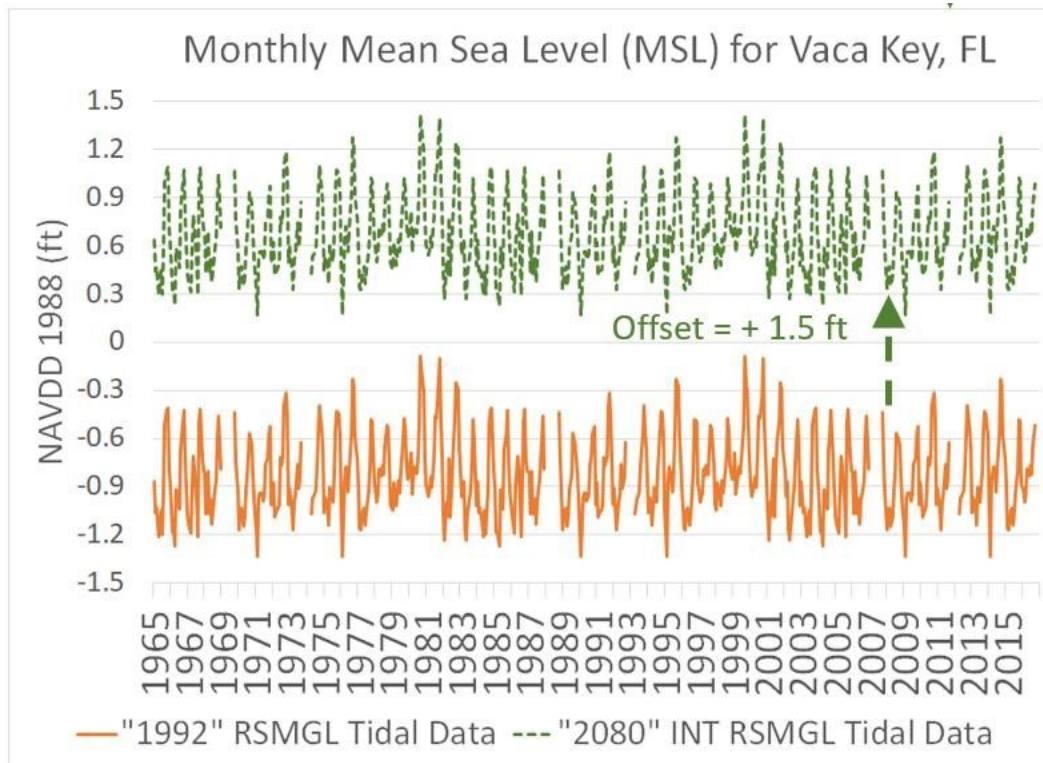

Figure 3. Example tidal observational dataset offset for future SLR.

Temperature, Rainfall and Evapotranspiration

Temperature changes and their effects on rainfall and evapotranspiration will likely have a major effect on water supply. In anticipation of this and other District resiliency efforts, the United States Geological Survey (USGS) and Florida International University (FIU) are partnering with the District to assess and develop suites of rainfall and ET datasets to be used for regional and subregional planning.

These datasets are designed around the premise that climate conditions are non-stationary and therefore incorporate evolving conditions. The non-stationary conditions use Global Circulation Models (GCM), which include empirical and physics-based models that incorporate elements of dynamics, chemistry, and biology of the atmosphere, biosphere, and the oceans as well as greenhouse gas emissions. These GCM have large scales (100km-250km) and therefore need to be downscaled to regional and subregional levels.

The preliminary projection ranges produced by FIU and USGS used statistically and dynamically downscaled datasets. Each of these downscaled datasets were statically analyzed and compared to each other and to observational data. The top ten best performing models with the highest correlation, low root means square error, and a Climate Performance Index (MCI) < 0 and a Model Variability Index (MVI) < 0 for each climate region were selected for the determination of scenario ranges. Figure 4 summarizes the approach used to develop the future climate datasets.

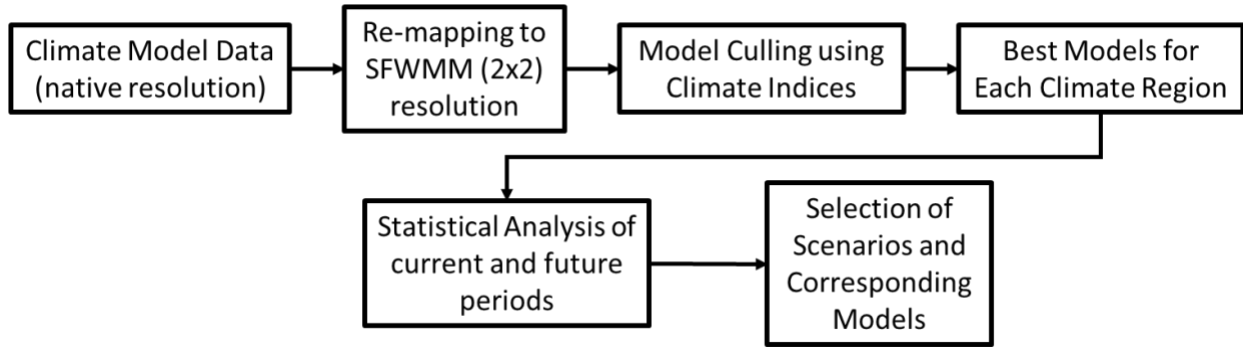

Figure 4. Summary of the adopted approach to modeling future climate scenarios.

While full ET projections require additional climatic variables such as wind speed and relative humidity, temperature is one of the primary drivers and an output of the produced datasets. Figure 5 shows that the average daily maximum temperature is expected to increase considerably. Higher temperatures especially at night result in greater water losses and therefore increased demands.

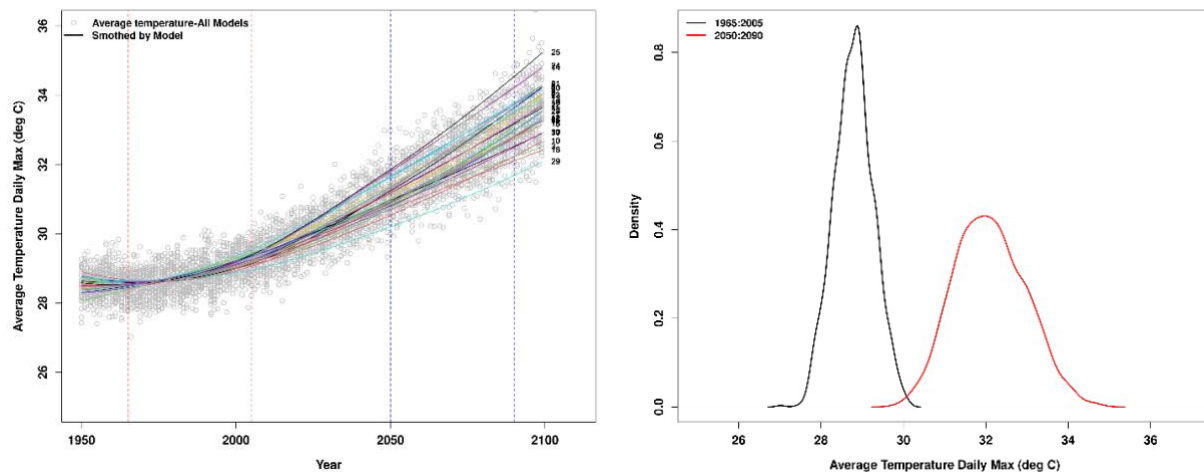

Figure 5. Time Series of gridded average tasmax for all climate models in the LOCA dataset, (b) Kernel Density Functions of tasmax for base and future periods.

Additionally, an overall decrease in annual total precipitation is initially predicted as shown in Figure 6 below.

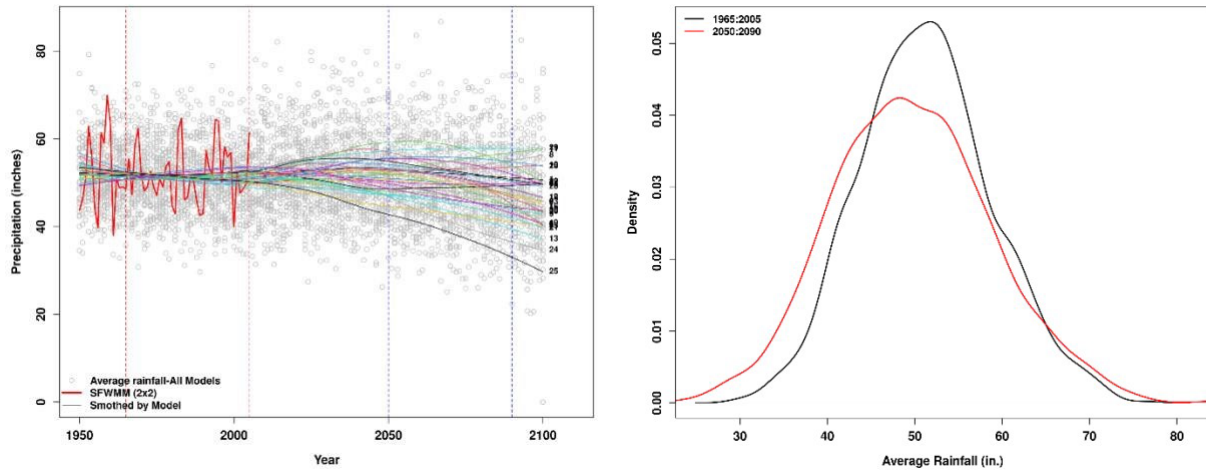

Figure 6. Time Series of gridded average rainfall for all climate models in the LOCA dataset. Also shown is the SFWMM (2x2) average rainfall and smoothed PRCPTOT for each model.

There will be further development and evaluations of the above summarized approach and their eventual datasets based on the model input needs. This development will likely result in future climate datasets that can be used throughout the District’s modeling efforts and will follow a thorough internal review process. Additional regional future conditions temperature, rainfall, and ET projections may be developed to fully address future climate scenario uncertainty and will depend on the regional groundwater and surface water model’s needs and outputs. The results will be updated and shared as they are developed.

Water Availability

System Overview

When assessing the vulnerability of water supplies due to climate change, there are many assumptions and simplifications that must be considered. By using the models and frameworks represented in the LEC WSP as a starting point, we can create an approach for how model outputs may be interpreted and used to understand system vulnerability. At the same time, we can analyze each element in the system as an independent entity with vulnerabilities related to its inputs, outputs, demands, management systems, and additional inherent characteristics.

The Block Diagram in Figure 7 shows how the interactions between the hydrologic system are modeled in the South Florida Water Management Model (SFWMM). For the proposed assessment, a similar simplified diagram was developed below to highlight the intricate hydrology of South Florida and how the influence of future climate conditions and demands will be analyzed and understood from a systematic vulnerability point of view. The System Vulnerability BlockDiagram in Figure 9 and its legend in Figure 8 is based on segmentation of the hydrologic characteristics as they are described in the LEC WSP. It should be noted that major assumptions regarding

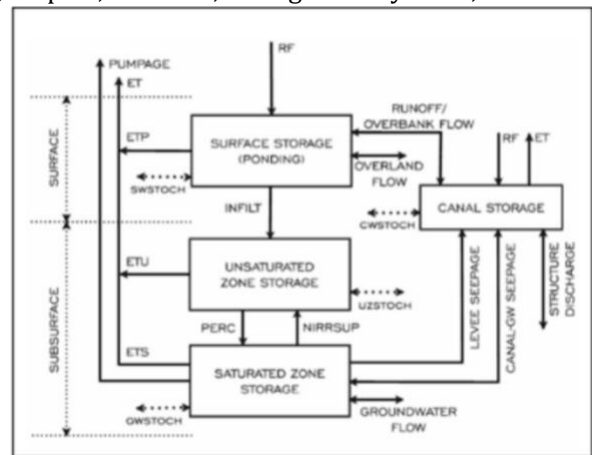

Figure 7. SFWMM Block Diagram.

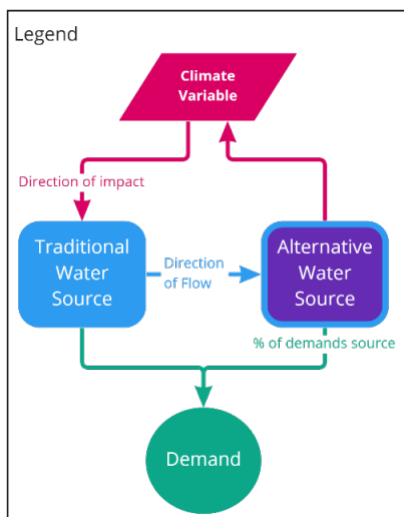

Figure 8. System Vulnerability

ecosystem demands and flood protection management are included in model development but not shown below.

The parallelograms represent the climate vulnerability variables that will be changing in the proposed assessment. The rectangles with the rounded edges represent water sources with blue fill representing traditional water sources and purple fill representing alternative water sources. The circles represent demands, and each color corresponds to a different demand use case. The connections with arrows indicate flow of water with blue representing regular water flows, red representing climate variable, and multi-color demands representing each source of demand with the associated percentage from source as indicated in the 2018 LEC WSP Demands.

Note: Shallow impoundments, unsaturated zones, canals, lakes, and reservoirs are combined as surface water for simplification of demand allocation. Additionally, SLR may have numerous cascading

Block impacts; however, we are still unsure of its effect on the overall supply and demand. SLR will be incorporated as boundary conditions and therefore doesn't have an arrow indicated direction of flow or impact.

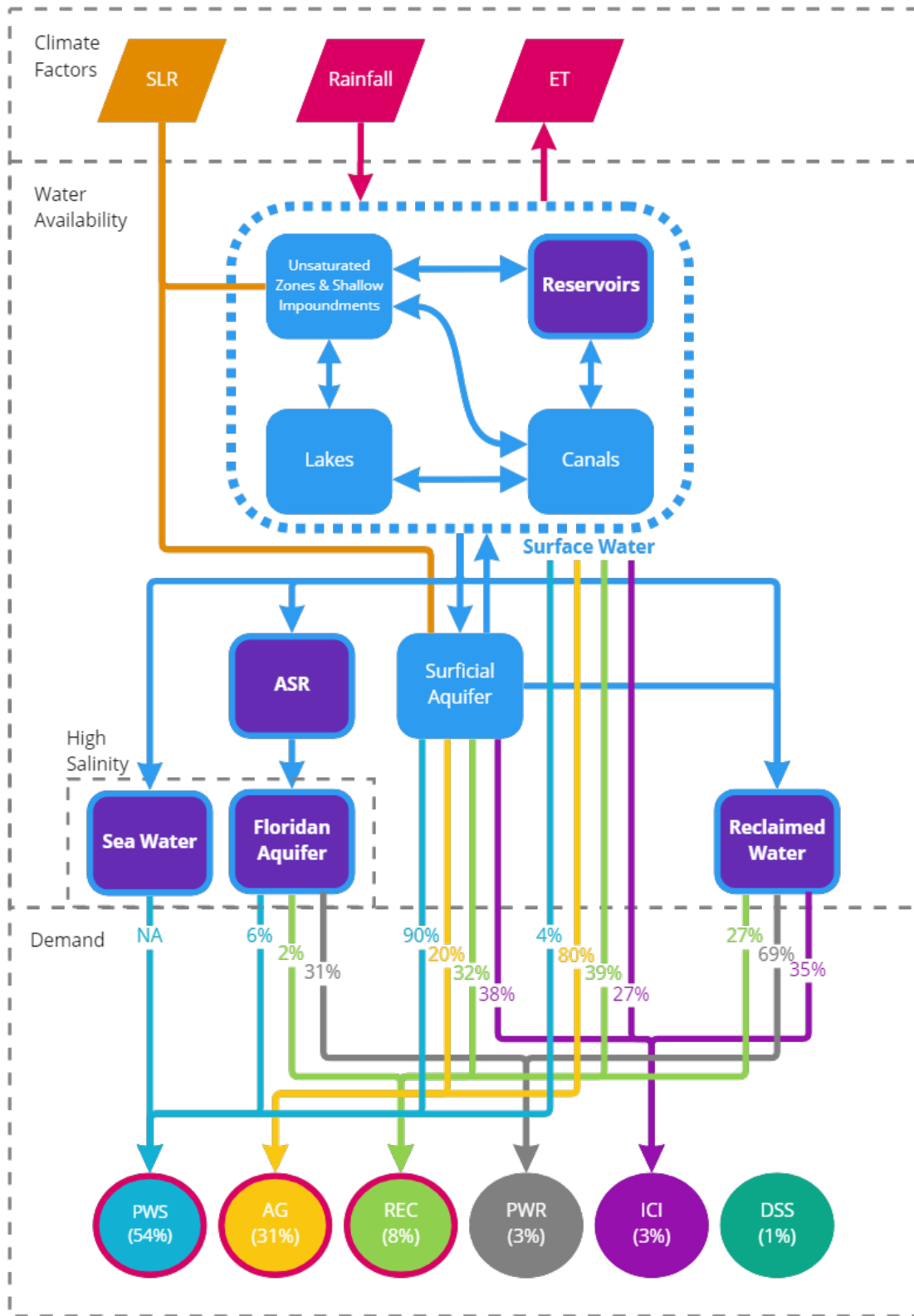

Figure 9. Vulnerability Block Diagram highlighting climate influences, supply sources, and demand.

Models

In the LEC, there are three major surface and groundwater water models to support the assessment of the regional water resources system: the East Coast Surficial Model (ECSM), the Regional Simulation Model (RSM), and the South Florida Water Management Model (SFWMM or 2-by-2). The ECSM, RSM, and SFWMM are all being recommended for the WSVA as they model different components of the system that need to complement each other to get comprehensive and accurate scenario runs. Various water sources and sinks, boundary conditions, and management systems may be captured in one model but not the other and so connections between them have to be established. As model simulations are developed, they need to be continuously checked and equilibrated. This iteration between models is a complex, time consuming, resource intensive, and essential process that ensures results are comprehensive and valid.

The ECSM is a regional model extending north to south from Vero Beach to Marathon and east to west from the Atlantic Coast to the L-2 Canal. While the ECSM is the primary model to be used for the WSVA, the RSM and SFWMM runs will be used to develop the boundary conditions for the ECSM including those related to structure operations and flows from Lake Okeechobee. The ECSM is a 5-layer model that uses daily stress periods with a 1,000 ft x 1,000 ft cell size grid to provide information on daily water levels, monthly total dissolved solids (TDS) concentrations, and 30-day average structure flows. The ECSM code is based on SEAWAT v 4.0 and uses specialized District packages among which are the wetland, routing, and data management packages. After calibration and peer review, ECSM will be used to simulate demands for the 2023 LEC WSP Update and then the WSVA.

The RSM simulates the coupled movement and distribution of groundwater and surface water in conjunction with the coordinated operation of canals and water control structures in South Florida. The RSM has two principal components, the Hydrologic Simulation Engine (HSE) and the Management Simulation Engine (MSE). These components allow for the simulation of management actions and their hydrologic responses. The HSE simulates natural hydrology, water control features, water conveyance systems and water control bodies. The HSE component solves the governing equations of water flow through both the natural hydrologic system and the man-made structures. The MSE component provides a wide range of operational and management capabilities to the RSM by implementing water control structure rules, canal stage maintenance levels and reservoir operating guidelines. Since there is not a single unique way that operations can be executed, the MSE is designed to provide a flexible, extensible expression of management simulation and optimization targets employing a suite of modern control algorithms.

The SFWMM is a regional-scale model that simulates the hydrology and the management of the water resources system from Lake Okeechobee to Florida Bay. It covers an area of 7,600 square miles using a mesh of 2x2 mile cells. In addition, the model includes inflows from the Kissimmee River, and runoff and demands in the Caloosahatchee River and St. Lucie Canal basins. The model simulates the major components of the hydrologic cycle in south Florida including rainfall, evapotranspiration, infiltration, overland and groundwater flow, canal flow, canal groundwater seepage, levee seepage and groundwater pumping. It incorporates current or proposed water management control structures and current or proposed operational rules. The ability to simulate water shortage policies affecting urban and agricultural water uses, and environmental needs in South Florida is a major strength of this model. The SFWMM simulates hydrology daily using observational climatic data periods which includes droughts and wet periods.

There are many other District models some of which are used for water supply purposes like the East Coast Floridan Aquifer System Model (ECFM). However, these models are not highlighted in this report as they will likely not be used to conduct the assessment.

Defining and Measuring Vulnerability

Defining and measuring water supply vulnerability are independent yet connected resiliency concepts. For this assessment, they are combined in that we are only able to measure the parameters that the models can capture, and therefore vulnerability is defined based on model output metrics. As the WSVAs are run, the assessment will further define the thresholds and perhaps additional metrics for each output. These thresholds will likely depend on various factors such as location, hydrologic context and impact, demand dependencies, or even the ease of implementing a particular adaptation or mitigation strategy. These vulnerability definitions and thresholds will be based on model outputs and were initially considered as part of workgroup selection of relevant recommended metrics.

To develop recommendations for analyzing source vulnerabilities, the workgroup segmented each of availability sources into “buckets” based on their hydrologic similarities, management systems, and modeling capabilities and to highlight the temporal and spatial stressors and stresses characteristic to each type of source. For example, the recommended outputs for the bucket representing canals are storage and stage. These are recommended based on the ability for the models to compute those metrics, their usefulness to water managers and planners, and their potential for assessing future demand and climate impacts among other considerations (see Canals). IDEF0 diagrams were developed for each source to facilitate workgroup discussion and their input assumptions and output recommendations are discussed below.

Figure 10 depicts how each bucket’s variables are defined. Blue arrows represent the flow of water and red arrows represent climate variables potentially impacting the respective source as part of the proposed assessment. Orange lines represent how each bucket is modeled and therefore potentially what its input requirements and output limitations are. Black lines represent District management systems that may be impacted as part of the vulnerability assessment. Lastly, the top right box contains the recommended output metrics that will be used to measure relative vulnerability and the bottom right box contains major model input assumptions identified by the workgroup.

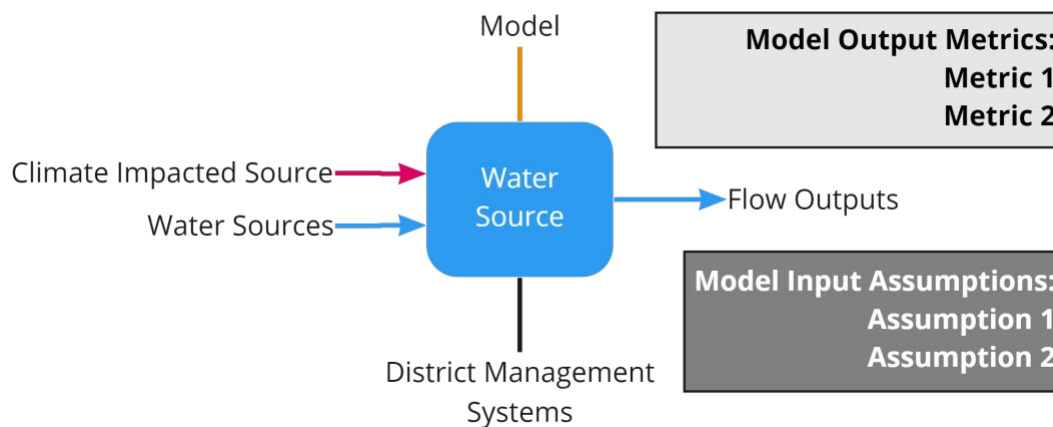

Figure 10. IDEF0 diagram legend for water availability sources.

Availability Sources

It is recommended that for the WSVAs the following be analyzed as independent and combined availability sources: shallow impoundments, unsaturated groundwater, canals, lakes, reservoirs, and the surficial aquifer. Future assessments may include analyzing the Floridan Aquifer, reclaimed water, seawater, and Aquifer Storage and Recovery (ASR).

Note: Environmental (ENV) water needs including supply to Everglades National Park and other water conservation areas are met via different assumptions and related management strategies such as Minimum Flows and Minimum Levels (MFL) and Restricted Allocation Areas (RAAs). These assumptions may not be called out specifically; however, they are incorporated as the assumptions carried over from adopting WSP methodologies. Additionally, all approved future Comprehensive Everglades Restoration Plan (CERP) projects that are part of the Integrated Delivery Schedule and are currently being modeled as part of the CERP Update effort, are suggested to be included as future condition simulation assumptions.

Shallow Impoundments

Shallow impoundments are all confined and unconfined surface water accumulation that is not otherwise segmented in the block diagram in Figure 9. This category includes vast swatches of wetlands, such as the Everglades National Park and Water Conservation Area or the Arthur R. Marshall Loxahatchee National Wildlife Refuge, as well as dispersed water management projects. These features will be represented in the ECSM layer 1 and likely simulated through the Wetlands Package.

The major features included in shallow impoundments are Water Conservation Areas (WCA), Stormwater Treatment Areas (STA), and Surface Water Management Areas (SWM). This bucket is currently modeled primarily by the SFWMM and the RSM. The District regulates this bucket as part of MFL and Water Use Permits (WUP) for some AG and REC demands. In addition to precipitation, water flows into shallow impoundments via urban and rural surface runoff, as well as from groundwater, canals, lakes, and reservoirs. Water flows out of shallow impoundments to canals to AG and REC Demand and to the Surficial Aquifer via recharge into the unsaturated and saturated zones of groundwater. Shallow impoundments do have associated losses via ET. The climatically impacted input parameters are SLR, rainfall, ET and AG and REC demands. The effects of SLR on shallow impoundments may be a result of SLR effects on higher groundwater elevations however this bucket will likely not have a SLR component beyond the indirect effects of SLR boundary conditions in the various models. Figure 11 shows an overview of the bucket representing shallow impoundments.

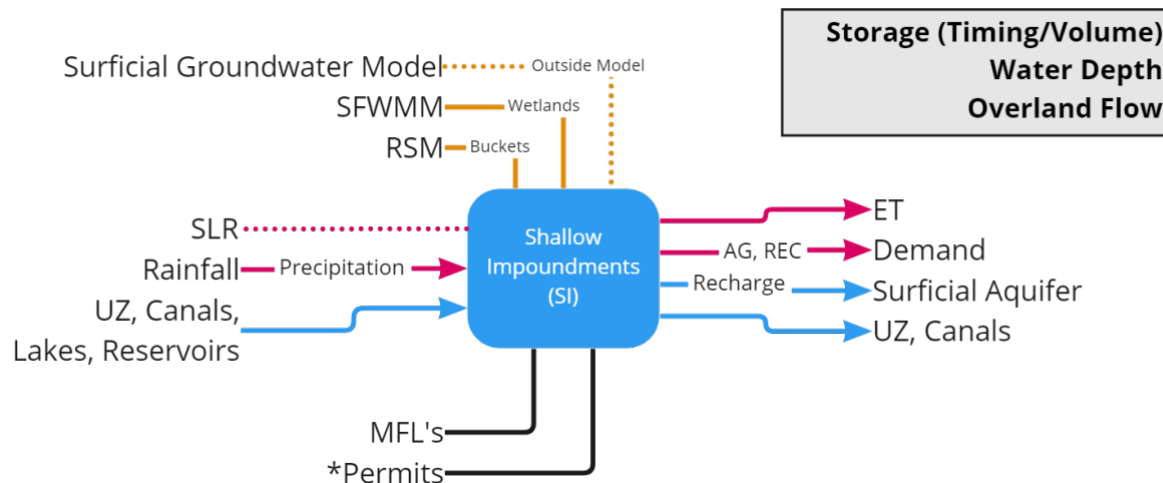

Figure 11. Shallow Impoundment IDEF0 Diagram.

Based on the above-mentioned inflows, outflows, and model constraints, and with a focus on how a vulnerability assessment may be used to assist with MFL and Permits, the following metrics were identified as model output variables: Storage, Water Depth, and Overland Flow rates. Storage will be assessed based on timing and volume and measuring what are the impacts of climate and demand input conditions. Pre-

established threshold values will assist in determining vulnerability. Water depth and overland flow are related to volume but as they relate to MFL triggers require their own independent analysis. The proposed assessment will aim to answer the question of if and when might a given climate change future condition trigger an MFL violation and/or a pre-determined vulnerability condition in addition to other questions.

Unsaturated Zones

The unsaturated zone (UZ) is characterized by many parameters that will likely have climate effects not featured in the proposed assessment such as changes in soil capacity and transmissivity. Included in the unsaturated zones are Lake Flirt Marl, Pamlico Sand, Miami Limestone, Fort Thompson Formation, and Key Largo Formation among others that will be represented in the ECSM layers 1, 2, and 3.

Unsaturated zones are currently modeled by the SFWMM and RSM. The District indirectly regulates the unsaturated zone mostly through withdrawal permits for some PWS, AG, REC, and DSS. The majority of PWS, AG, and REC demand is permitted through the saturated zones represented as the Surficial Aquifer however there is a close relationship between both zones. In addition to rainfall, water flows into the unsaturated zones via urban and rural surface runoff infiltration, and as direct infiltration from ponded water sources including shallow impoundments, canals, lakes, and reservoirs. Water flows out of the unsaturated zones to PWS, AG, REC, and DSS demand to the Surficial Aquifer via recharge and as losses via ET. The climatically impacted parameters are SLR, precipitation, ET and AG and REC demand. The effects of SLR on the unsaturated zones will be analyzed through the models. Rainfall and ET will be incorporated as through the above-mentioned datasets directly incorporated into the model, along with AFSIRS input withdrawal rates. Figure 12 shows an overview of the unsaturated zones bucket.

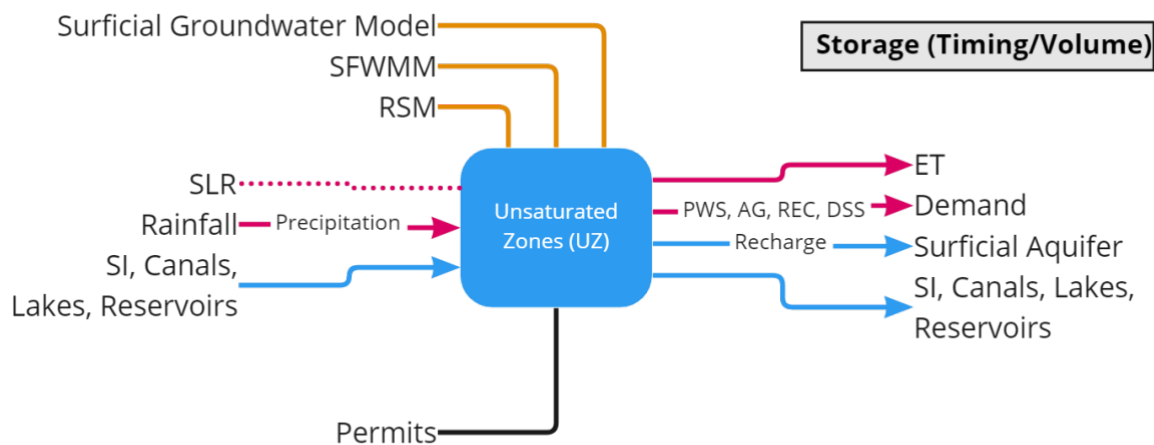

Figure 12. Unsaturated Zone IDEF0 Diagram.

Changes in storage, timing and volume were identified as model output variables based on the abovementioned inflows, outflows, and model constraints and with a focus on how a vulnerability assessment may be used to support permitting. It should be noted that soil capacity changes both in terms of storage potential and through porosity recharge rates will likely be affected by climate change; however, due to the lack of scientific consensus, uncertainty in approach, and modeling difficulty this change factor will not be incorporated into the proposed assessment. There is an additional planning project highlighted in the 2022 Resiliency Plan that may look at the climate change effects on those parameters.

Canals

South Florida's canals were primarily developed for flood protection and prevention of saltwater intrusion in 1948, as part of the Central and Southern Florida Project (C&SF Project) and act a major conduit of the regions' fresh water. Canal operations are tied to water management operation goals, established in specific operation manuals.

Canals are currently modeled by the ECSM, SFWMM, and RSM as part of WSP and many other District modeling efforts such as CERP and FPLOS. Water levels in the canals are impacted by structures operation, RAAs, MFLs, and a few AG withdrawal permits. In addition to rainfall, water flows into the canals via urban and rural surface runoff, infiltration from groundwater, and flows from shallow impoundments, secondary canals, lakes, and reservoirs. Water flows out of canals to tide, AG demand, to the Surficial Aquifer via recharge, as losses via ET, and into lakes and reservoirs. Figure 13 shows an overview of the unsaturated zones bucket.

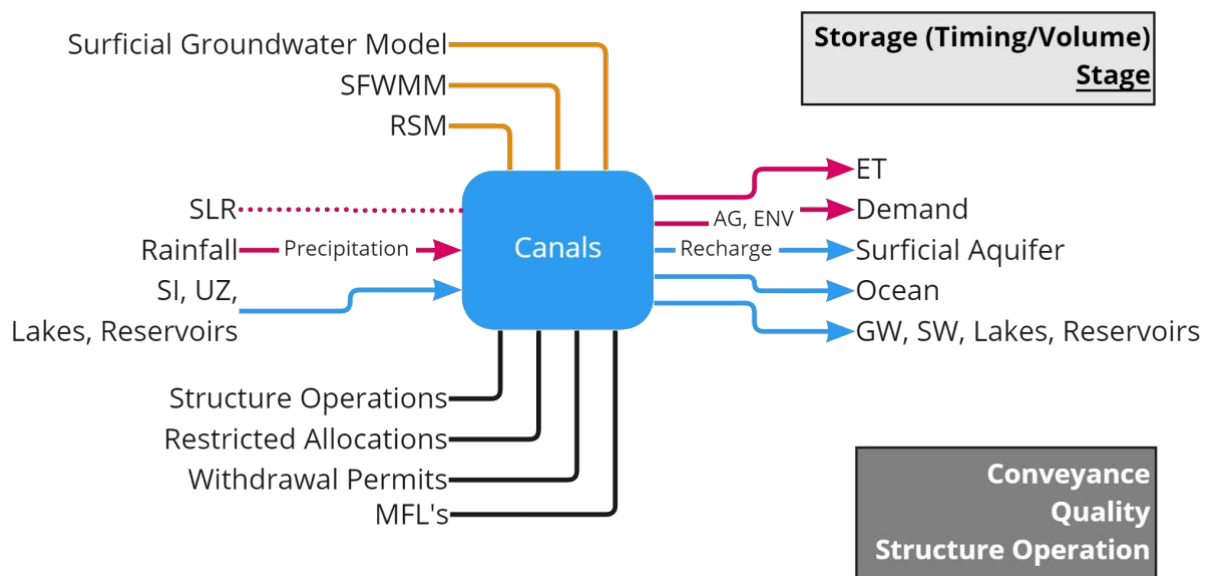

Figure 13. Canals IDEF0 Diagram.

The climatically impacted parameters are SLR, precipitation, ET, and AG demands and ENV needs. The effects of SLR on the canals is very important to consider as their stages are triggers from MFL and RAA. Additionally, they are used as withdraw limitation assumptions in the ECSM model runs. The effects of SLR will likely result in operational changes and structure enhancements first, which might have greater impacts than purely increasing or decreasing demand. Although unlikely, operations may also change because of water quality conditions to prevent downstream negative ecological affects. Furthermore, the canals are operated to prevent saltwater intrusion in addition to its primary flood protection objectives, as such their conveyance characteristics take precedent over storage and quality considerations. Therefore, maintaining conveyance and assumptions regarding quality and other structure operational decisions will be modeled as inputs rather than outputs.

To support decision making for operations, permits, and other regulatory procedures managed by the district, the stage of water in the canals as well as storage in terms of volume and timing are the expected vulnerability outputs. These outputs may take the form of time to trigger a particular structure operation, MFL, or RAAs.

Lakes

Small lakes and shallow impoundments may have similar functional and modeling characteristics, however, there are significant source demand differences such as the City of West Palm Beach's water supply from Lake Magnolia and Clear Lake, when compared to shallow impoundments, that are not a direct sources of water supply. Similarly, Lake Okeechobee's cubic mile of water is the heart of the surface water system in South Florida and its tributaries and distributaries are the supply and source for much of the regions fresh water. Many assumptions and modeling inputs are based on Lake Okeechobee's regulatory and hydrologic conditions.

Lakes, such as stormwater management lakes, are currently modeled by the ECSM, SFWMM, and RSM. Lake levels are impacted by operations of inflow and outflow structures, MFL, WUP and ERPs. Water flows into lakes via rainfall, urban and rural surface runoff, infiltration from groundwater, and through canals and outfalls. Water flows out of lakes via operation of outflow structures. For Lake Okeechobee, these operations will be simulated according to the 2023 Lake Okeechobee System Operating Manual (LOSOM) schedule, which includes sending water to Everglades National Park, estuaries, and other environmental and regional demands. Lakes additionally have components of PWS, AG, and REC demands. Water also flows to the Surficial Aquifer via recharge, as losses via ET, and into groundwater via infiltration. Figure 14 shows an overview of the bucket representing lakes.

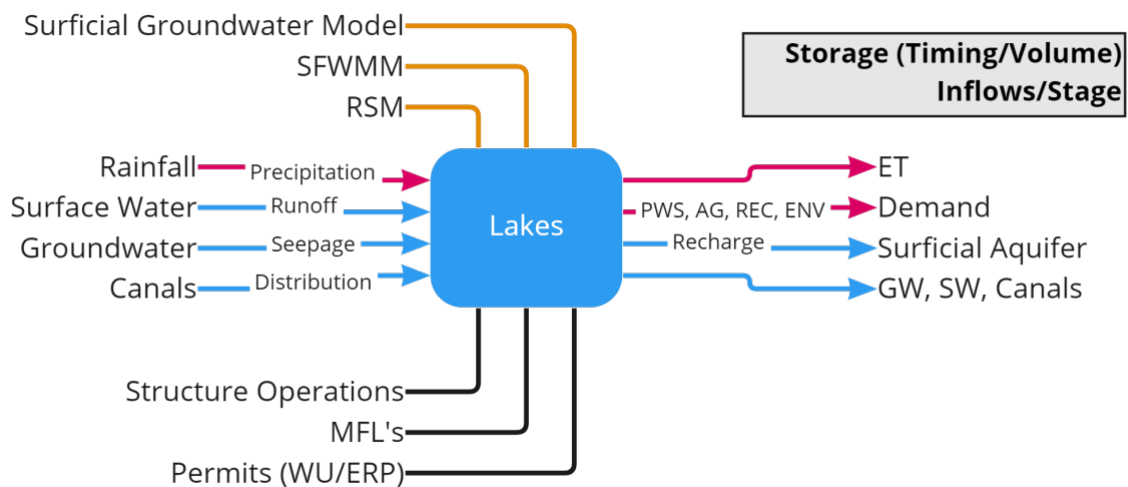

Figure 14. Lakes IDEF0 Diagram.

The effect of climate change on lake conditions will likely be caused by changes in rainfall, ET, and ecosystem and consumer demand. SLR's impact is expected to occur because of drainage and canal conveyance from downstream conditions. The major output metrics associated with lakes are the storage and inflow/outflow rates. MFL triggers and their timing will also likely be a threshold of interest just as they are with canals.

Reservoirs

Reservoirs in the region serve multiple purposes including flood protection and ecosystem water supply needs. The C-51 is a recent example of a reservoir developed for consumer water supply needs which, upon completion, will be operated and managed by the District and serve as supplemental water supply to eight

local water utilities. Additionally, Flow Equalization Basins (FEB) whose primary design is for storm water management purposes also serve as reservoirs.

Reservoirs are currently modeled by the ECSM, SFWMM, and RSM as well as individual and independent specific modeling for future reservoir development and other operational objectives like ecosystem restoration and flood protection. The District manages reservoirs through operations of structures, WUP, ERP (where District is the permittee), and Dam Safety permits. Water flows into reservoirs via urban and rural surface runoff, infiltration from groundwater, and pumped in via canals. Water flows out of reservoirs to PWS, AG, and PWR demand, to the Surficial Aquifer via recharge, as losses via ET, and into other sources via pumping from canals. Figure 15 shows an overview of the unsaturated zones bucket.

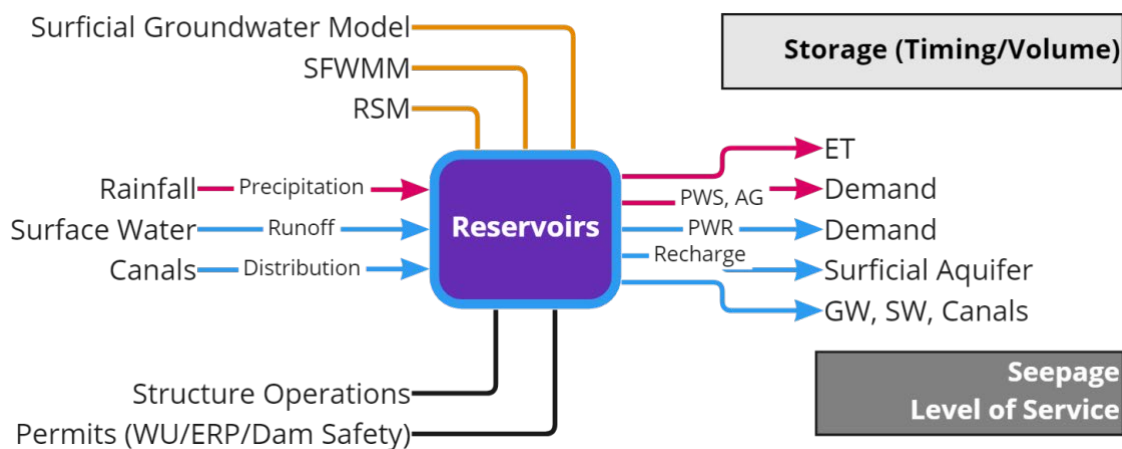

Figure 15. Reservoirs IDEF0 Diagram.

While reservoirs are intended to store water, they aren't fully impervious and therefore do contribute to groundwater via seepage which will be incorporated as a model assumption. Additionally, reservoirs act as storm water buffers and their flood protection level of service assumptions take precedent over storage and as such will be model input assumptions. Storage in terms of volume and timing will be the assessed vulnerability metric and threshold.

Surficial Aquifer

The surficial aquifer is the primary focus of the proposed assessment as it supplies 90% of PWS, 20% of AG, 32% of REC, and 38% of ICI, totaling 55% of the LEC water demands in addition to the portion of water that is later reclaimed. The surficial aquifer is fully encompassed in the ECSM model.

The surficial aquifer is currently modeled by the ECSM, SFWMM, and RSM. The District manages withdrawals from the surficial aquifer through WUPs, RAA, and storm water disposal. Water flows into the surficial aquifer via recharge from all surface water sources during the wet season. Water flows out of the surficial aquifer to PWS, AG, REC, ICI, and DSS demand, back to surface water sources, as losses via ET, and out to tide through the regional canal network. Figure 16 shows an overview of the surficial aquifer bucket.

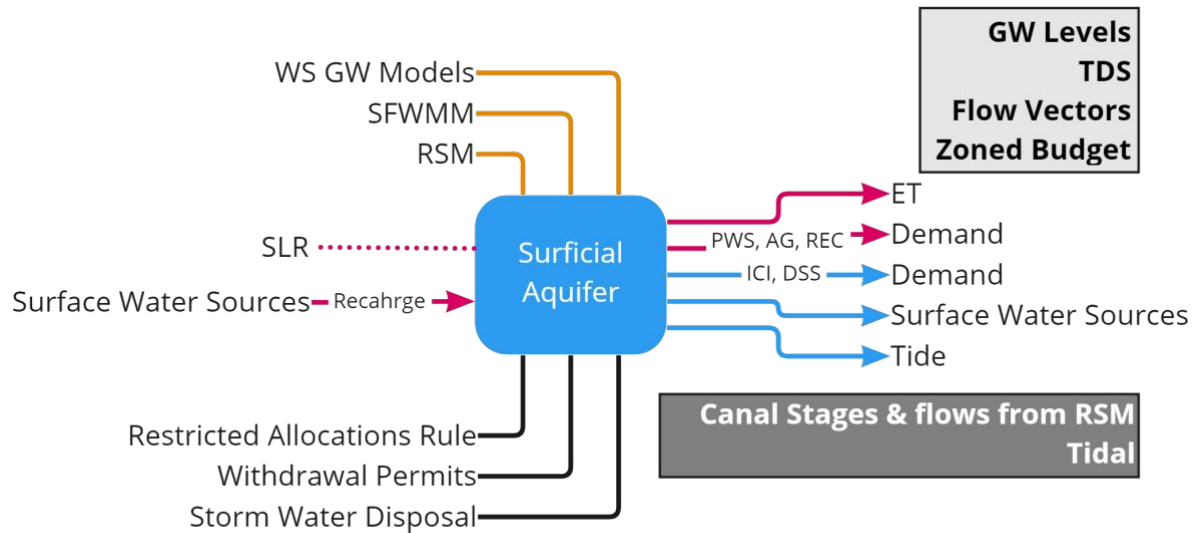

Figure 16. Surficial Aquifer IDEF0 Diagram.

The surficial aquifer is connected to all surface water sources and the effects of demand through surficial aquifer withdrawals cascade throughout other sources in the system. For instance, an inland PS well cone of depression can cause water levels to drop in nearby canal which can trigger an MFL violation related to Lake Okeechobee, especially in drier conditions. Similarly, PWS wellfield withdrawals and their future growth are limited by the RAAs in the LEC. Coastal wellfields will further be evaluated, as part of this assessment, to characterize vulnerability related to the migration of saline water/saltwater intrusion. Modeling and optimizing the responses to potential further demand restrictions will be included as assumptions, inputs, and rules and adaptation responses

Additionally, an assumption is placed on the limits of PS demands as maximum withdraws and the proposed assessment will help us understand what future conditions cause us to reach those limits and when. There are also assumptions made from flows done in the RSM that are inputs to the ECSM as boundary conditions. Lastly, as the ECSM is a density-dependent model, SLR will be modeled as tidal boundary condition that will likely not change with time throughout the model run.

The density-dependent ECSM allows for a more robust analysis of groundwater. Based on its capabilities, the vulnerability output will include groundwater levels, salinity concentrations via Total Dissolved Solids (TDS), flow vectors (direction and magnitude of flow), and zoned budget analysis i.e., how much volume, inflow, and outflow a particular area has. TDS concentrations output will allow for water quality degradation to be analyzed spatially. The flow vectors can show what is the cause various flows of water i.e., is withdrawal the cause for lower canal levels or is it the drier regional conditions. This can help planners and regulatory staff identify potential mitigation strategies or begin the process of updated guidelines based on what works and what drives vulnerability. The zoned budget analysis can provide agencies and planners with an understanding of what their future condition and supply may look like in terms of volume and provide them with guidance on how to plan and regulate accordingly.

Figure 17 contains the combined model input assumptions and model output metrics for each availability source that are initially suggested to go in the development of the assessment and model runs.

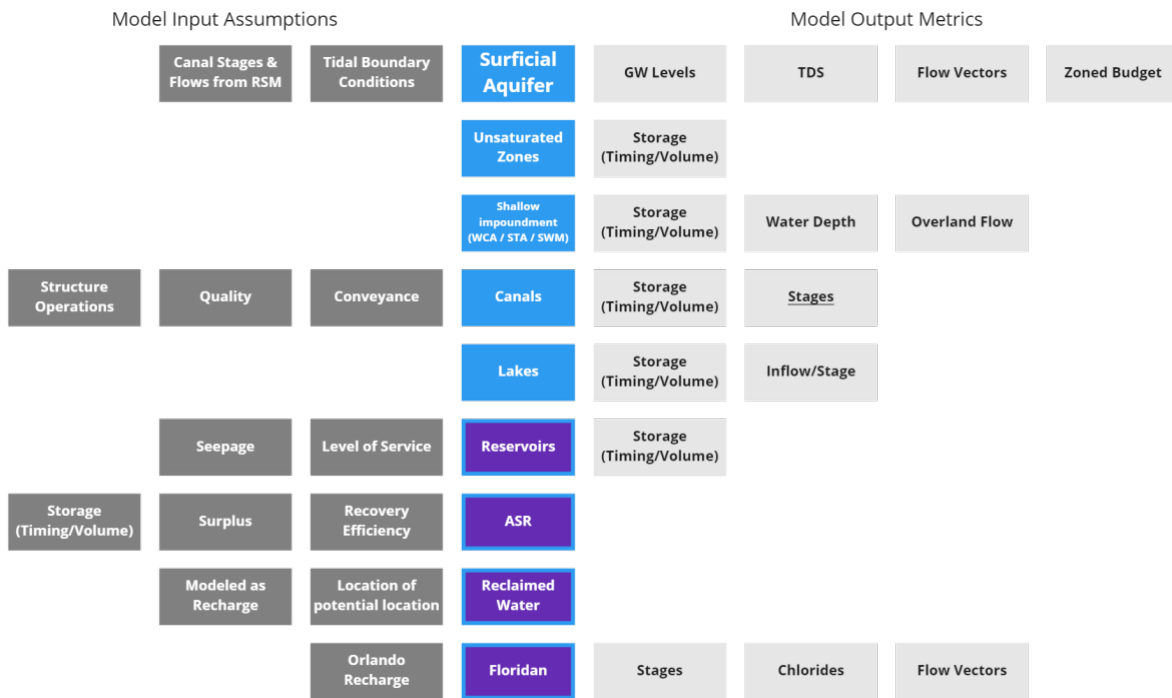

Figure 17. Diagram of the availability metrics and assumptions.

Scenario Formulation

Based on the above research and discussion and approaches identified by the workgroup, the scenario model runs were recommended based on less and more conservative climate change conditions and on a range of growth scenarios within the determined 50-year planning horizon. Selected individual runs are recommended to isolate effects independent of each other. Table 3 defines each of the independent variables that will change with each model run.

Table 3. Independent model variables and their definitions.

Name	Definition	Dataset
Current Climate	Observational data	1985 – 2016 (POR)
2020 Growth Scenario	Base Condition	1985 – 2016 (POR)
2045 Growth Scenario	20-year planning horizon	BEBR Median 2045
2075 Growth Scenario	50-year planning horizon	BEBR Median 2075
Sea Level Rise 1 (SLR1)	NOAA Intermediate Low	NOAA 2022 Update
Sea Level Rise 2 (SLR2)	NOAA Intermediate High	NOAA 2022 Update
Climate Change 1	Warm and Drier	FIU/USGS Future Conditions
Climate Change 2	Hot and Driest	FIU/USGS Future Conditions
Less Conservative	Warm, Drier, & SLR1	Combined
More Conservative	Hot, Driest, & SLR2	Combined

Growth will be evaluated as 2020 Growth Scenario, 2045 Growth Scenario, and 2075 Growth Scenario. 2020 Growth Scenario is defined as the current population at the time of the of the model run. 2045 Growth Scenario is defined as the population growth up to the end of the LEC WSP time horizon (2045) which is based on BEBR Median growth projections. 2075 Growth Scenario is defined as the extrapolation of BEBR Median growth projections out to the end of the 50-year time horizon (centered around 2075).

Sea Level Rise 1 (SLR1) is defined as the 2022 NOAA Intermediate-Low curve as the tidal boundary conditions which reflects the 17th percentile of the projected ranges. Sea Level Rise 2 (SLR2) is defined as the 2022 NOAA Intermediate-High curve as the tidal boundary conditions which reflects the 83rd percentile of the projected ranges.

Climate change will be evaluated on a scale of temperature and moisture (hotter and drier) conditions based on future temperature, rainfall, and ET models and datasets. The runs will be classified into four categories, Climate Change 1 & 2, and Less and More Conservative estimates. Climate Change 1 is defined as warmer and drier conditions which will reflect the respective percentile future condition (around 5-25 percentile: lower bottom of ranges) for temperature, rainfall, and ET in 50 years (centered around 2075). Climate Change 2 is defined as the respective percentile future condition (75-95 percentile: upper bottom of ranges) for temperature, rainfall, and ET in 50 years. Less Conservative is defined as Climate Change 1 with SLR 1, and More Conservative is defined at Climate Change 2 with SLR 2.

The first scenarios will be developed for the 2023 Update to the LEC WSP. These include the 2020 base condition (Current Climate and 2020 Growth Scenario), the 2045 future demand condition (Current Climate and 2045 Growth Scenario), and the 2045 Sea Level Rise Condition (SLR1 and 2045 Growth Scenario). These runs, designated A, B, and G in Figure 18 will serve as the basis for the information contained in the

WSP. The climate period of record will use 1985 to 2016 and the SLR boundary conditions will be based on existing tidal conditions for A and B, and SLR 1 for C.

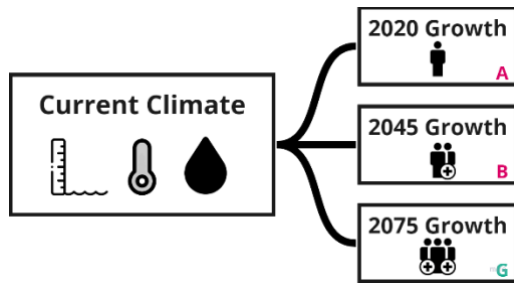

Figure 18. Current climate scenario diagram.

Following the initial LEC WSP scenarios, the first vulnerability scenarios to run will be the 2045 Growth with Climate Change 1, Less Conservative, and More Conservative conditions, designated as D, E, and F. These runs will build on run C by adding climate variables to previous runs and then comparing the effects. The second round of the vulnerability assessment runs are 2075 Growth with No Change, SLR1, Climate Change 1, Less Conservative, and More Conservative conditions, designated as G, H, I, J, and K. These runs represent the total future condition as they combine 2075 growth conditions with 50-year climate and SLR conditions. Figure 19 and Table 4 represent the vulnerability assessment scenario runs.

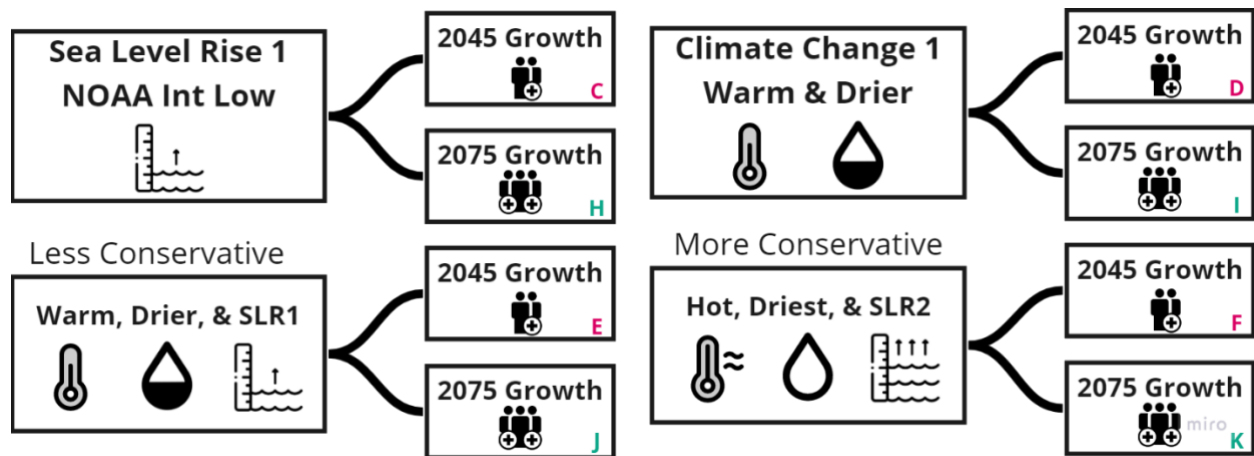

Figure 19. SLR1, Climate Change 1, Less Conservative, and More Conservative scenario diagram.

Table 4. Model run designation and associated independent variables.

Scenario Run	Growth Variable	Climate Variable
A (LEC WSP)	Base Conditions	Current Climate
B (LEC WSP)	BEBR Med 2045	Current Climate
C (LEC WSP)	BEBR Med 2045	SLR1
D (WS Vuln)	BEBR Med 2045	Warmer and Drier
E (WS Vuln)	BEBR Med 2045	Warmer, Drier, & SLR1
F (WS Vuln)	BEBR Med 2045	Hot, Driest, & SLR2
G (WS Vuln)	BEBR Med 2075	Current Climate
H (WS Vuln)	BEBR Med 2075	SLR1
I (WS Vuln)	BEBR Med 2075	Warmer and Drier
J (WS Vuln)	BEBR Med 2075	Warmer, Drier, & SLR1
K (WS Vuln)	BEBR Med 2075	Hot, Driest, & SLR2

Expected Outcomes

Based on the above scenarios and the availability thresholds and metrics discussed above, outputs can be used to determine how a particular sources availability behaves over time. This source behavior can be depicted in a variety of different outputs from geographic maps, tables, and graphs which can then be used to assist management and planning processes accordingly. For example, Figure 20 depicts an illustrative example output comparing a theoretical source volume and demand in model runs A, E, and F, No Change and No Growth and Low Growth with Less and More Conservative conditions. The source volume is shown in purple and grey and is plotted against its low growth demand in gold and green no growth demand in blue. This graph shows us when demand may exceed supply and how the timeline need to enact management practice changes with different conditions. (Note: This output is for illustrative purposes and is not representative of any source, condition, or actual expected outcome.)

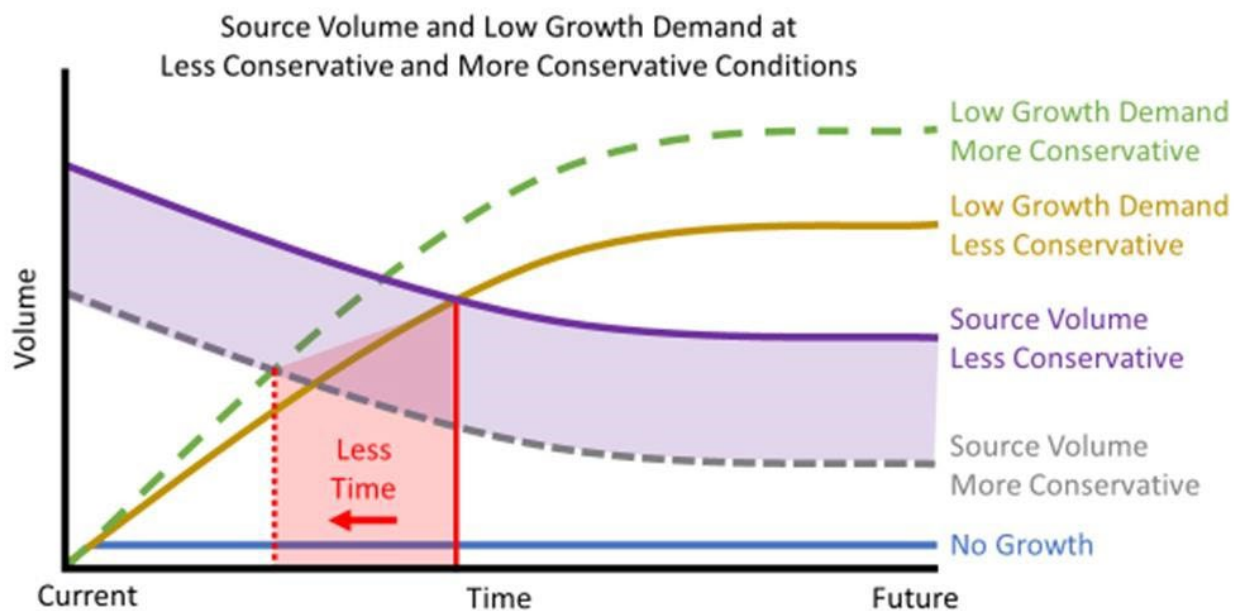

Figure 20. Example assessment output comparing a theoretical source volume and demand for model runs A, E, and F.

In addition to supporting planning efforts the outputs can be used to identify and define risk thresholds. For instance, a system or source can be defined as “at risk” when it’s within a certain timeframe from reaching a variable threshold. This can support various mitigation efforts such as grant applications to allow development of alternative water supplies or rule-making to further restrict use from at risk sources.

Scenario Limitations and Timeline

The time it takes to set up, troubleshoot, and run each model places limitations on the scope of the study. Once the ECSM has been calibrated, additional time is needed to set up the new scenario runs and execute these modeling runs. These challenges are compounded with the longer time horizon and the novelty of incorporating new elements such as density dependence, in addition to the above-mentioned need of equilibrating multiple models.

New datasets such as future temperature, rainfall, and ET and future growth projections will be developed as model inputs. The development of these datasets will require additional parallel efforts and increased costs. In anticipation of these and other model requirements the scoping of necessary parallel efforts will begin immediately. Table 5 shows the anticipated timeline for the future condition development, model development, model runs, and analysis, leveraging the model development advanced as part of the LEC WSP.

Table 5. Anticipated timeline of the WSVA.

Water Supply Vulnerability Analysis (WSVA) Schedule		FY22				FY23				FY24				FY25
		Q1	Q2	Q3	Q4	Q1	Q2	Q3	Q4	Q1	Q2	Q3	Q4	Q1
WSVA Approach	Internal Workgroup													
	Report Draft and Review													
Future Conditions Dataset Dev.	Population Projection													
	Climate Dataset													
	Internal Data Processing													
Model Dev. & WSP Run	ECSM Update/Calibration*													
	LEC WSP Scenario Runs*													
WSVA Run & Analysis	WSVA Scenario Runs													
	WSVA Analysis and Report													

* the LEC WSP model development, calibration and scenario runs are illustrated here for planning purposes only and are not dependent on any of the described WSVA tasks.

Future Work

“An ounce of prevention is worth a pound of cure” – Benjamin Franklin

In addition to the initial recommendations described above, which are being prioritized as part of the initial study recommendations, future efforts, as detailed below, were identified by the Workgroup, and will be further developed as part of future study phases. It is important to note that the first phase of the WSVA is to develop a series of base climate conditions on which to apply various mitigation and adaptation strategies. Like the FPLoS program, base conditions are first developed, which inform the appropriate mitigation and adaptation strategies to then be modeled.

Future Scenarios

Future scenarios should include the incorporation of alternative mitigation strategies into modeling. These mitigation strategies can help managers understand the resiliency strategies that may be attained to reduce vulnerabilities. While there are many potential mitigation strategies, Figure 21 shows a few potential mitigation strategies that might be organized as part of additional scenario runs roped in Mitigation Strategies Scenarios.

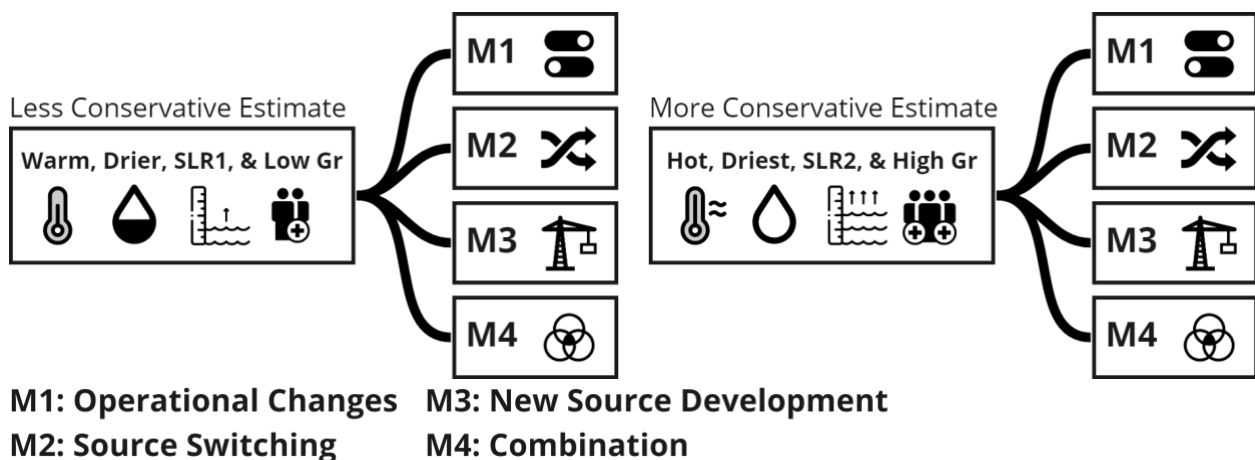

Figure 21. Mitigation scenarios runs.

M1 corresponds to operational change which in the above scenarios are input assumptions. These assumptions can be optimized with a given climate condition and requires no additional infrastructure investment. However, there are many objectives that determine the operational procedures of various structures which can compete with one another and have complex interdependent regulatory constraints. Therefore, modeling this mitigation strategy is not trivial and will require additional discussion. M2 corresponds to source switch which assumes that demands will be met with different sources throughout the model time frames. The scenarios above discuss the assumption that demand will be capped at the RAA limitation. M2 analyses would evaluate if some of the demands were met by sources like reclaimed water or via distribution from other utilities. M3 corresponds to the development of new sources such as additional Floridan aquifer or seawater. Historically, development of new sources has been a popular management practice for utilities who are approaching their RAA limitations or at risk of saltwater intrusion. M4 corresponds to a combination of all the above-mentioned strategies and may include projections for increased conservation.

These strategies can be combined with outputs mentioned previously and can assist with the identification of water supply priority resiliency investments. Figure 22 shows an illustrative potential output that shows the effect of M3 on source volume and highlights how that may increase the timeline for mitigation or adaptation to climate change. Similarly, it can also help define vulnerabilities based on the time it takes to implement various mitigation strategies, their likelihood of success, and potential impact. For instance, new source development may temporarily solve a supply shortage but may also be the only available mitigation strategy so that a particular source or location is therefore “at risk”.

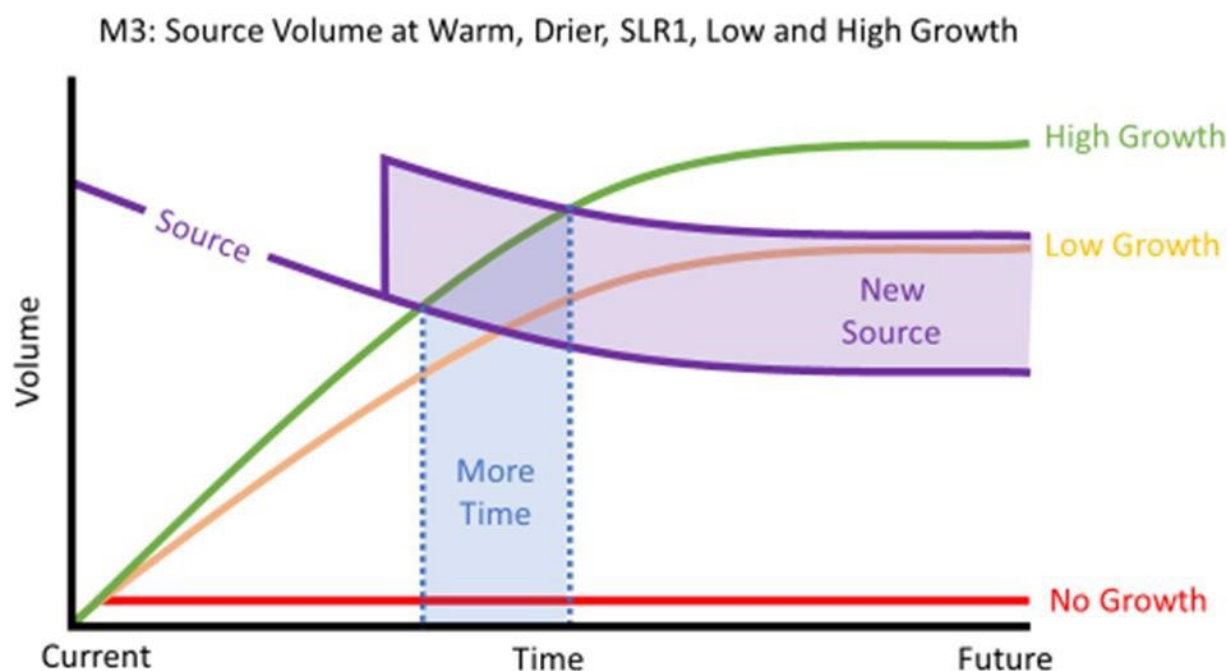

Figure 22. Example mitigation scenario output highlighting the effect of new supply sources.

Not Assessed Availability Sources

Reclaimed water, ASR and the Floridan Aquifer are sources whose vulnerability are not being recommended to be directly analyzed as part of the initial phases of the proposed assessment. While these sources play an essential role in the LEC water supply system, in the case of ASR and Reclaimed Water, they are potential mitigation and adaptation strategies, and in the case of the Floridan Aquifer are likely more affected by future demand conditions rather than the climate change conditions featured in the proposed assessment (SLR, temperature, rainfall, and ET). Future analysis may independently look at the climate vulnerabilities associated with each of these sources.

Appendix A: Water Use Category Growth and Withdrawal Rates Workgroup Discussion

How a particular water use category demand change over time is combination of its growth rate and withdrawal rate. The growth rate is a function of the projected growth of that industry such population increases, irrigated acreage increase/decrease or the square footage of industrial or commercial space. The withdrawal rate is the estimate water use per unit to calculate the overall demand for that water use

category. Water use per unit can include per capita water use for public supply and domestic self-supply, water needs per acre of crop for agriculture, or water needs per acre of landscape or golf course. Changing climate can impact the water use per unit, especially for water use categories that include irrigation.

For the proposed assessment, growth rates are separated from withdrawal rates to allow for the application of an independent climate focused methodology where applicable and feasible. Each of these rate's variables may have important climate change components but their relationships and model inputs would have to be sufficiently established to be incorporated into the WSPA which may be beyond the scope of the proposed assessment especially for growth rates. Alternatively, the approach to apply the effects of climate change on withdrawal rates have a clearer methodology and the process of applying them is relatively straight forward.

The use categories follow the 2018 LEC WSP methodology and are segmented as Public Supply (PS), Agriculture (AG), Landscape and Recreation (REC), Institutional, Commercial, and Industrial (ICI), Power (PWR) and Domestic Self Supply (DSS). Below are the explanations, discussions, and research for the above use category growth rates. For each water use category, a series of boxes are presented showing options considered by the workgroup with the light green box indicating the option the workgroup suggests adopting.

A.1: Water Use Category Growth Rates

Public Supply Growth Rates

Figure 23 shows options presented to the workgroup based on research of the latest scientific methodology and strategies implemented by similar agencies.



Figure 23. Public Supply growth rate options.

In the WSP, PS growth is derived from multiple sources of information, including county-level data from the University of Florida Bureau of Economic and Business Research (BEBR), sub-county data from Traffic Analysis Zones (TAZ), and local data from local government comprehensive plans and United States census. BEBR 20-year projections are conducted at the county level. These county-level projections are distributed by District staff via TAZ and census data to utility service areas whose boundaries are updated annually. The BEBR projection serves as the control for the county-wide projection when combining individual utility service area populations. Estimates of DDS population within the utility service area is subtracted from the utility service area population to estimate the utility-served population. In addition, local government plans for providing utility service in current DSS areas are incorporated in the projections.

When projecting growth rates in PS, factors to consider include the projection methodology underlying the rates themselves and how they will be distributed spatially within utility service areas. While these are connected, climate influences may have different impacts on each aspect. For instance, increased coastal flooding due to climate change can change how population growth gets distributed within service areas and between utilities but may not have as consequential an effect on overall growth rates.

While there are uncertainties with population growth rates and distribution methodology even at 20 years, PS must be assessed with future conditions as it's the demand category that has the largest demands associated with assessed sources. Based on this need, similar scientifically or legally verified methodologies

were researched that can either extrapolate BEBR projections or be applied to conduct independent projections for a 40-50 planning horizon.

As an example, the C-51 reservoir project required permittees to conduct long-term demand projections. While the methodology used in the permittees' projections varied across utilities based on their internal demand segmentation and fee-rate projection procedures, the overall approach was to extrapolate population growth rates through a moving average percent difference. This percent difference is then applied to future years until the end of the assessment period.

For the proposed WSVA, a similar extrapolation methodology is suggested to be applied to county populations and then spatially distributed according to current WSP methodology.

PS Growth Rate Assumptions

There are several assumptions and uncertainties embedded within the projections and methodologies, some of which are:

- All the assumptions and uncertainties within BEBR's projection methodologies are carried over into our extrapolation. BEBR's methodology is simplified as follows: $P_t = (H_t \times PPH_t) + GQ_t$, where P_t is the population at time t , H_t is the number of occupied housing units at time t , PPH_t is the average number of persons per household at time t , and GQ_t is the group quarters population at time t . Notably, seasonal residents and undocumented persons are not formally incorporated as part of the permanent population (however their withdrawal rates are likely captured in percapita use rate). Additionally, birth rates, death rates, national and international migration rates, and other persons factors are simplified within the PPH_t term.
- Spatial distribution of BEBR projections to utility boundary lines are accurate.
- The effects of Covid-19 have intruded additional uncertainties and growth rate extrapolations will not be modified accordingly.
- The significance factor and variability of each of the parameters with BEBR projections carry over to extrapolated numbers.
- The plateau effect of the population projection implies a leveling off of future growth.
- Climate change effects were not incorporated into projection methodologies or distribution.

PS Growth Rate Research

Below are relevant highlights from research conducted to supplement the workgroup's decision-making process.

- BEBR has conducted long-term population projections for the Florida 2070 project.
- Miami-Dade County conducted long-term projections for sewer flows.
- C-51 Reservoir Permit required long-term projections. Methodologies documented were Dania Beach Utilities, Hallandale Beach Utilities, The City of Sunrise, City of Margate, City of Ft Lauderdale, City of Pompano Beach, Miami-Dade Water and Sewer Department, and Broward County.
- State of Oregon conducted long-term projects and found population to be more influential than changes in use types.
- Washington State conducted long-term linear projections.
- Seattle Utilities did population forecast until 2040 and then a linear extrapolation until 2060.
- Thames Water used a cohort-component "industry standard" incorporating population, housing and occupancy in long-term component and applied a percentage growth rate from government population data.

Agricultural Growth Rates

Figure 24 shows the options presented to the workgroup based on research of the latest scientific methodology and strategies implemented by similar agencies.

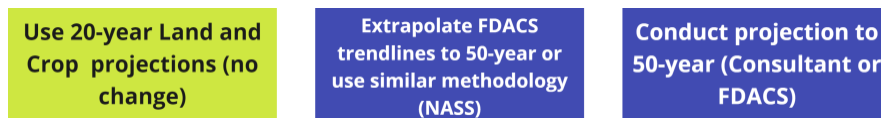

Figure 24. Agricultural growth rate options.

The WSP methodology for projecting agricultural growth is based on the irrigated agriculture growth maps generated by Florida Department of Agriculture and Consumer Services (FDACS) in the Florida Statewide Agricultural Irrigation Demand (FSAID) report. These reports are generated annually and contain parcel-level polygons of statewide agricultural lands (ALG) and agricultural irrigated lands (ILG) including crop type projected out to 25 years. These projections are based on USDA National Agricultural Statistics Service (NASS) using standard trend analysis with data from 1987-2017. County-level trends used an autoregressive procedure where the best functional fit was selected from logarithmic, linear, exponential, and power forms. Crop-type projections and their subsequent withdrawal rates are discussed in the Withdrawal Rates section.

Based on the current use of FSAID AG acreage projections in WSPs, the workgroup recommended use of 20-year growth rate projections rather than extrapolate FSAID trendlines using similar methodology conducted by FDACS to develop future land projections or to conduct new projections with a new methodology. The FSAID growth rates are tied to crop types and acreages and developing new procedures or attempting to project spatially distributed crop types extrapolated from the FSAID report is beyond the scope of the proposed assessment due to high uncertainty. These uncertainties while climatically relevant include elements such as long-term land use changes and future crop type demand which are unreasonable to assume at 50 years.

AG Growth Rate Assumptions

There are several assumptions and uncertainties embedded within projecting Agricultural growth rates using FDACS's FSAID data, some of which are:

- FSAID geographic land use changes don't consider climate change factors such as the effects of increased drought or the shift from agricultural land to housing due to increased inland migration
- NASS statistics use census and survey information of which data is often voluntary and therefore incomplete.
- Land use change plans rarely exceed 10 – 20 years and therefore projection of potential land use changes beyond even up to 20 years is uncertain.
- Trendlines using various regressions rather than model-based approaches don't capture the reasons behind various changes and can therefore be less encompassing of future changes.
- The Coronavirus pandemic caused various changes that affected land use such as increased Florida migration and lower demand of restaurant produce. Incorporating these and other Covid19 impacts may change future predictions.

AG Growth Rate Research

Below are relevant highlights from research conducted to supplement the workgroup's decision-making process.

- Oregon used acreages by land use by county, distribution by crop by county, crop specific irrigation demands. Did not project land use changes.

Landscape and Recreation Growth Rates

Figure 25 and Figure 26 shows the options presented to the workgroup based on research of the latest scientific methodology and strategies implemented by similar agencies.

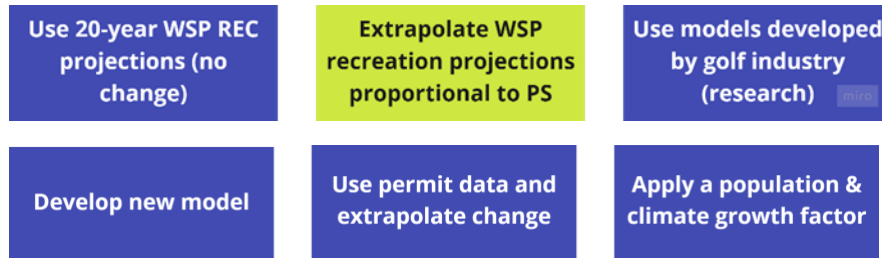

Figure 25. Recreational growth rate options.

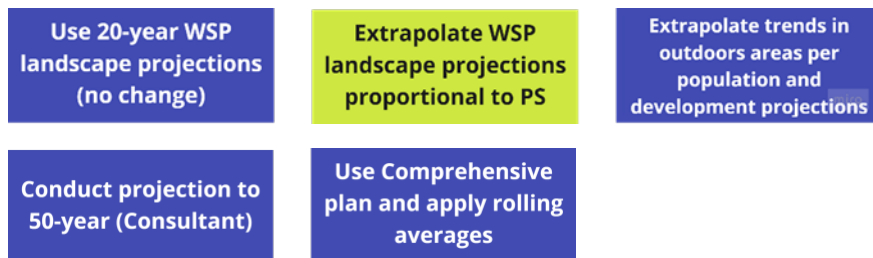

Figure 26. Landscape growth rate options.

In the LEC WSP, growth in REC demands were increased proportionally with population growth. However, because golf is a unique use case that accounts for a significant portion of REC demand and is influenced by different parameters than other recreation and landscape uses its growth is segmented from other REC demands and is added on a case-by-cases basis.

Golf growth rates have been minimal or declining in the past decade. As a result, increases in golf are added to a WSP on case-by-case basis where there are water use permits and/or planned growth documenting increases in golf but not projected. The golf industry had been seeing a steady decline until Covid-19 where the trend reversed; however, projecting future growth rates is too uncertain. To allow for the comparison to WSP -- and to balance scope with the additional uncertainties -- it is suggested that the proposed assessment maintain the same 20-year acreages and growth rates determined in the WSP.

REC Growth Rate Assumptions

There are several assumptions and uncertainties embedded in using the WSP current Landscape and Recreational growth rate methodologies, some of which are:

- Landscape growth within the PS utility service area is accounted for with the PS population growth rate, which implies irrigated landscape grows at the same rate as population. This is conservative but unlikely as the average household size in the LEC is increasing and there have been considerably more construction of apartments and multifamily homes than single-family homes, which translates to less lawns per capita.
- The projections are limited to known upcoming water use permits and only 10 years of expected land use changes.
- All parks and other recreation are assumed to grow proportionally to population.

- The effects of climate change will not be incorporated into REC growth. WSP use WUP and known new development to determine new REC locations and manually update associated demands on the WSP 5-year update schedule.

REC Growth Rate Research

Below are relevant highlights from research conducted to supplement the workgroup's decision-making process.

- ASCE found that different plot types (single, multifamily, commercial) have a considerable effect on predictive demand because of increased lawns.
- Municipal and industrial demand growth is most closely associated with population growth.
- Golf courses were on the decline and land use was often switching to housing development but picked back up during the Coronavirus Pandemic so future growth is more uncertain.

Industrial, Commercial, and Institutional Growth Rates

Figure 27 shows the options presented to the workgroup based on research of the latest scientific methodology and strategies implemented by similar agencies.



Figure 27. Industrial, Commercial, and Institutional growth rates options.

ICI is primarily differentiated from other business use cases by it being self-supplied and not sourced from a utility (PS). The largest ICI use cases are from agricultural produce processing and mining and the majority of ICI growth is associated with mining for increased population. Currently, ICI growth is captured with the addition of known permits and population projections.

If both utility and self-supply Industrial, Commercial, and Institutional users could be segmented then independent growth variables could be associated with each segment and their impact and contribution to withdrawal rates could be more accurately planned. However, due to current data limitations from utilities, segmentation of users is not viable, and creating new data requirements is beyond the scope of this exercise. Additionally, extrapolating the growth rates of self-supplied ICI and applying climate dependent coefficients would likely introduce uncertainty. Therefore, maintaining the existing WSP methodology is suggested for the proposed WSVA assessment.

ICI Growth Rate Assumptions

There are several assumptions and uncertainties embedded within the WSP current ICI growth rate methodologies, some of which are:

- Various ICI uses and growth rates are embedded in PS and are therefore assumed to grow relative to population.
- WSP ICI additions are only done on a case-by-case basis and therefore not projected.
- Climate change considerations and industry influences are not incorporated; however, may have an effect especially as agriculture processing technology improves.

ICI Growth Rate Research

Below are relevant highlights from research conducted to supplement the workgroup's decision-making process.

- A District economist found a correlation between water supply growth with the mining industry and population growth. This is likely related to the needs for construction materials as population increases.
- London segments water demand and growth rates by business sector and assigns a Gross Value Added as an informant factor in their modeling. This modeling uses individual growth rate coefficients per business sector.

Power Growth Rate

Figure 28 shows the options presented to the workgroup based on research of the latest scientific methodology and strategies implemented by similar agencies.



Figure 28. Power Generation growth options.

Current WSP methodologies incorporate PWR growth in an additive stepwise fashion as PWR demand is primarily associated with cooling requirements for power generating facilities. Additional growth is only incorporated with the development of new power facilities as defined and projected by those facilities in the utility's 10-year work plans, principally Florida Power & Light. Furthermore, future demand is at least partially expected to be met by renewable energy such as solar which has few to no water demand requirements.

There is a correlation between increased temperature and household cooling needs which may translate to increased demand on power producing facilities; however, the associated uncertainty is too high.

PWR Growth Rate Assumptions

There are several assumptions and uncertainties embedded within using the WSP current PWR growth methodologies, some of which are:

- Power growth is not projected in the WSP, unless provided by the utility's 10-year work plans.
- Power growth does include climate related factors.

PWR Growth Rate Research

Below are relevant highlights from research conducted to supplement the workgroup's decision-making process.

- Many studies show an increase in power consumption needs as the climate warms. This is particularly acute (increase in 25%) for warm tropical climates with cooling needs.
- A study found an increase of 11% in residential air conditioning cooling demand.
- A study found that increased temperatures of cooling water reduce cooling efficiency and thus requires more water. Additionally, increased salinity concentration limits the ability of cooling water to be re-used and may therefore increase water needs.

Domestic Self Supply Growth Rate

Figure 29 shows the options presented to the workgroup based on research of the latest scientific methodology and strategies implemented by similar agencies.

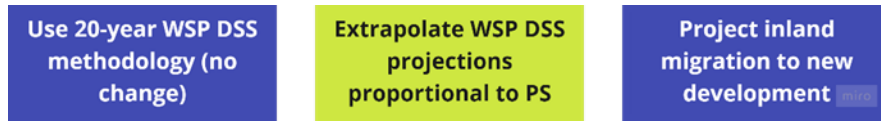

Figure 29. Domestic Self Supply growth options.

DSS projections are developed simultaneously with PS population estimates and projections. Although DSS is defined as self-supplied, often DSS users are within utility boundaries as it may be cheaper for the user to maintain an existing well or drill a new well rather than connecting to the utility. The WSP applies BEBR population growth to DSS. All permanent residents outside of PS utility service area boundaries are considered DSS population. Estimates of DDS population within the utility service area is subtracted from the utility service area population to estimate the utility-served population. In addition, local government plans for providing utility service in current DSS areas are incorporated in the projections, which result in decreases in DSS.

The increase in population is mostly closely associated with urban growth which is supplied by PS; therefore, the growth rates theoretically do not have to be proportional as DSS users may not necessarily be growing at that rate. However, even though the increase in demand may be due to additional urban growth, perhaps the lower cost to develop new DSS and its higher demand rates will end up being proportional to overall demands caused by population growth. Because of these considerations, maintaining the population trendline increase applied to PS was recommended.

DSS Growth Rate Assumptions

There are several assumptions and uncertainties embedded within the WSP current DSS growth methodologies, some of which are as follows:

- Trends in land use changes are not incorporated
- Population served by PS grows at the rate as DSS
- DSS will not grow or shrink because of climate change impacts (such as drought and potentially lower water tables)

A.2: Water Demands and Withdrawal Rates

The following sections will discuss projecting future water needs as they relate to the growth recommendations highlighted earlier allocating these demands amongst sources. For instance, PS will incorporate an additional 30 years of population projections in its growth rate, and how demand will be distributed to each water source. The term “demand” throughout this section will refer to the withdrawal rate applied to the growth rate for each water use category.

Public Supply Withdrawal Rate

Figure 30 shows the options presented to the workgroup based on research of the latest scientific methodology and strategies implemented by similar agencies.

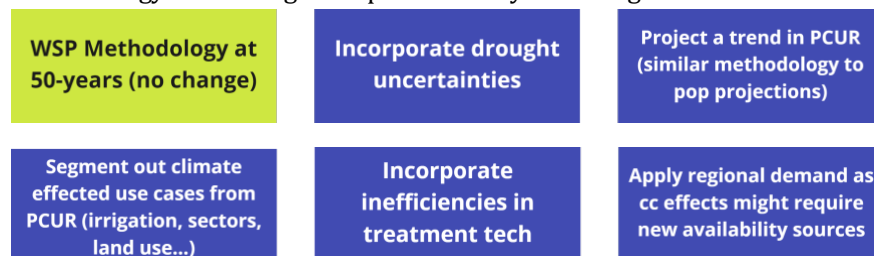

Figure 30. Public Supply withdrawal rate options.

In the 2018 LEC WSP, existing PS demands were met by the Surficial Aquifer (90%), the Floridan Aquifer (6%) and surface water sources (4%). The utility-specific PCUR is calculated in the WSP by taking the monthly and yearly utility-specific finished water data reported to Florida Department of Environmental Protection (FDEP) and dividing it by the utility's reported utility-served service area population. The most recent 5 years PCURs are averaged to develop an average utility-based PCUR which is then applied to the utility-served population projections to calculate the projected demand at five-year increments for a 20-year horizon. This is also referred to as the net (finished) demands. Gross (raw) water withdrawals are the volumes needed from the water source(s) to produce the required net (finished) water volumes, considering water treatment process losses. Water use permit allocations for PS utilities are based on the gross (raw) water volume to meet service area demands. To determine gross (raw) water demand for each PS utility, net (finished) water projections were multiplied by raw-to-finished ratios, which are based on the treatment efficiency of each PS water treatment plant. For example, if a typical membrane softening treatment facility withdraws a gross (raw) volume of 10.00 mgd and produces 9.00 mgd of net (finished) water, its treatment losses are 10%. Therefore, its raw-to-finished ratio would be 1.11 (10 mgd divided by 9 mgd).

Florida Statute specifies that the level of certainty planning goal associated with identifying demands shall be based upon meeting demands during a 1-in-10-year drought event (Section 373.709(2)(a)1, F.S. The increased PS demands during 1-in-10-year drought conditions are calculated using the method described in the Districtwide Water Supply Assessment (SFWMD 1998), which considers the increased demands on the irrigation portion of PS during droughts. The drought demand factors are 1.17 for Martin County, 1.09 for St. Lucie County, and 1.17 for northeastern Okeechobee County (within the UEC Planning Area) and 1.10 for Palm Beach and Broward counties, 1.07 for Miami-Dade County, 1.03 for Monroe County and 1.06 for Hendry County. Average water demands were multiplied by the drought demand factor to calculate demands during 1-in-10-year drought conditions. This demand is modeled with both an average rainfall year and a 1-in-10-year drought.

The average rainfall year is defined as a year having rainfall with a 50 percent probability of being exceeded in any other year and a 1-in-10-year drought is defined as a year in which below normal rainfall occurs with a 90 percent probability of being exceeded in any other year; expected return frequency of once in 10 years.

There are many variables that affect the uncertainties in future drought conditions which are mostly encapsulated in temperature, rainfall, and ET and as such it is suggested that drought be represented in the climate variables rather than as change in the withdrawal rate.

A potential consequence of applying a more conservative modeling approach is increases in water needs may be needed to ensure water supply in drying conditions than current needs, i.e., increased allocations and potentially more frequent water shortage restrictions. This can perhaps be explained by the local and regional nature of drought and the extreme hydrologic differences between various planning scenarios. It is therefore not suggested that for the purpose of the proposed assessment the definition of drought in terms of withdrawal rates be altered without regional consensus or state direction. Additionally, the SFWMD's permitting threshold and planning goal are both established with a 1-in-10-year level of certainty.

PCUR are defined essentially as moving averages and an option to apply an extrapolated version of PCUR is based on the similar extrapolation suggested for PS population growth rates. However, utility based PCUR are affected by many variables whose uncertainties would make it difficult to isolate their trends from their causes. For instance, a decreasing PCUR may be the result of plant treatment or distribution efficiency, increased water conservation, or distributed growth to housing with lower demands, all of which have may

have a different management response. Additionally, there exists gaps with current utility service boundary and use rate data. Making additional assumptions and their subsequent uncertainties would not be accurately captured without first developing new utility data standardization procedures which is beyond the scope of this effort. This is further emphasized given that many utilities conduct existing standard conservation plans rather than goal-based plans and may not be looking at or have different methodologies for understanding the causes, effects, and trends of different use categories. As a result, it is not suggested that trends in PCUR be extended beyond the WSP methodology.

Segmenting out climate affected use cases such as landscape irrigation that uses water from a PS utility or various climate affected business sectors can make the vulnerability assessment more robust. This segmentation would introduce the necessity for data that may not already exist; it would require the development of a new PCUR procedure and may not even have an applicable management consequence beyond the existing additional development of alternative water supplies or increased conservation. For instance, in certain areas, utility permit holders are intentionally limited by their withdrawal's ecological impacts and their ability to provide water for their customers as discussed in Restricted Allocation Area rules (RAA) and WSPs while others are limited by their projected demands. Because of source restrictions (RAAs), many utilities have developed or are planning to develop alternative water supplies beyond their current fresh groundwater allocations and are not planning an increase in permitted surficial aquifer or surface water withdrawals. Conservation is therefore incentivized by the utility to meet the demands limited by existing withdrawal limitations such as the increased costs associated with alternative water supply development or the changing of water supply treatment methodologies to more expensive desalination. Further incentive for alternative water supply development is encouraged through costshare opportunities and longer permit allocations; for example, most wells using the surficial aquifer must renew their permits every 10 years unless they meet the conditions of assurance, in which case it can be as long as 20 years. As an additional incentive to switch to alternative water sources, wells on the Floridan aquifer must renew their permits at a maximum of every 30 years. However, beyond the incentive and implementation challenges, segmenting out climate use cases may inform the redevelopment of existing rules to ensure continual supply. Due to a lack of comprehensive data, the need for developing new procedures, and the existing limitations already incentivizing resiliency, it is not suggested that climate-related use cases in PWS be segmented.

Withdrawal rates would need be altered to reflect a potential reduction in treatment efficiencies due to climate change. For instance, if modeling shows sea level rise exacerbating saltwater intrusion, then the treatment efficiencies of coastal utility may decrease, which may result in increased demand on the system. This, however, is not suggested to be included in the proposed assessment as there is not enough research nor clear methodology to adequately predict efficiency decline. Furthermore, utility responses to decreased efficiencies may result in the development of alternative water supply or other management actions that are difficult to model.

Lastly, a regional withdrawal rate could potentially be applied rather than through associated utility withdrawal rates. This idea was based on the concept of understanding vulnerability from a macro perspective with demand needs allocated as decision variables. However, this perspective ignores the reality of the demands caused by existing infrastructure, is extremely difficulty to develop, introduces new uncertainties, and removes the ability to provide localized and therefore meaningful outputs. It is therefore not suggested that a regional withdrawal rate be utilized as part of the proposed assessment.

Based on the above discussion it is suggested that the proposed assessment utilize the current WSP approach of applying averaged PCUR determined for the 20/25-year WSP and then applying them to increased growth associated with future conditions. Additionally, utilizing the current approach would require fewer additional model runs and less time needed to analyze and develop a new methodology.

Additionally, drought uncertainties would not be ignored but rather included in changing temperature, rainfall, and ET patterns.

PS Withdrawal Rate Assumptions

There are several assumptions and uncertainties embedded within using the WSP current PS withdrawal rate, some of which are as follows:

- PCUR includes households, landscape, and business uses in addition to losses and distributions efficiency. Many of these categories contain various climate affected use cases which are all included in the PCUR, increasing it uncertainty.
- Drought conditions are captured in 1-in-10 scenario runs. Increased drought uncertainties due to climate change are incorporated in temperature, rainfall, and ET changes. Future demand beyond RAA limits is assumed to be met by alternative water supply or conservation i.e., modeling will limit demands at RAA withdrawal limits.
- There are no econometric variables associated with growth or demand beyond those included in population projections.
-

PS Withdrawal Rate Research

Below are relevant research highlights.

- Seattle public withdrawal rates used price and other econometric variables.
- Washington State used and extrapolated per capita consumption withdrawal rate to 2075.
- Oregon uses a standardized data collection from providers and segments and applies different methodologies to various zones based on their expected growth.
- See research highlighted in PWS Growth Rate

Agricultural Withdrawal Rate

Figure 31 shows the options presented to the workgroup based on research of the latest scientific methodology and strategies implemented by similar agencies.



Figure 31. Agricultural demand options.

In the 2018 LEC WSP, existing Agricultural (AG) demands were met by surface water sources (80%) and the Surficial Aquifer (20%). The AG water withdrawal rate is determined in the WSP using the Agricultural Field Scale Irrigation Requirements Simulation (AFSIRS) model (Smajstrla 1990). The FDACS irrigated crop acres, soil types, growing seasons, and irrigation methods are used as input data for the AFSIRS model. AG withdrawal rate estimates and projections are based on the typical commercially grown crop categories developed by the FDEP and water management districts for use in water supply plans. The demands of these crops are then calculated for an average rainfall year and a 1-in-10-year drought. AFSIRS considers the parameters featured in the Figure 32 and illustrated in Figure 33.

Climate	Crop Data	Irrigation Efficiency	Soil Data	Land Use Data	Runoff
Daily Rainfall (NEXRAD)	Crop types [16 perennial (sugarcane, citrus, turf, etc) and 44 annual (vegetables)]	10 irrigation systems	773 detailed soil types by SCS (SSURGO)	Based on the ILG parcels	Runoff Curve Number (TR55, USDA)
Reference ET (RET) (USGS)	Crop coefficients (standard)	Percent irrigation efficiency	7 Generic Hydrologic Soil Groups (HSG)	Florida Land Use Cover Classification System (FLUCCS) Codes	
	Extinction depth/root zone depths (standard, crop based)	Percent area of soil surface irrigated	Infiltration: A - High, B - Moderate, C - Slow, D - Very Slow	Conversion table from FSAID ILG to AFSIRS detailed level crop codes	
	Growing seasons (for annual crops)	Percent fraction of ET from irrigated portion of crop root zone		at general use code level the categories crosswalk is direct 1 to 1	

Figure 32. AFSIRS parameters and data sources.

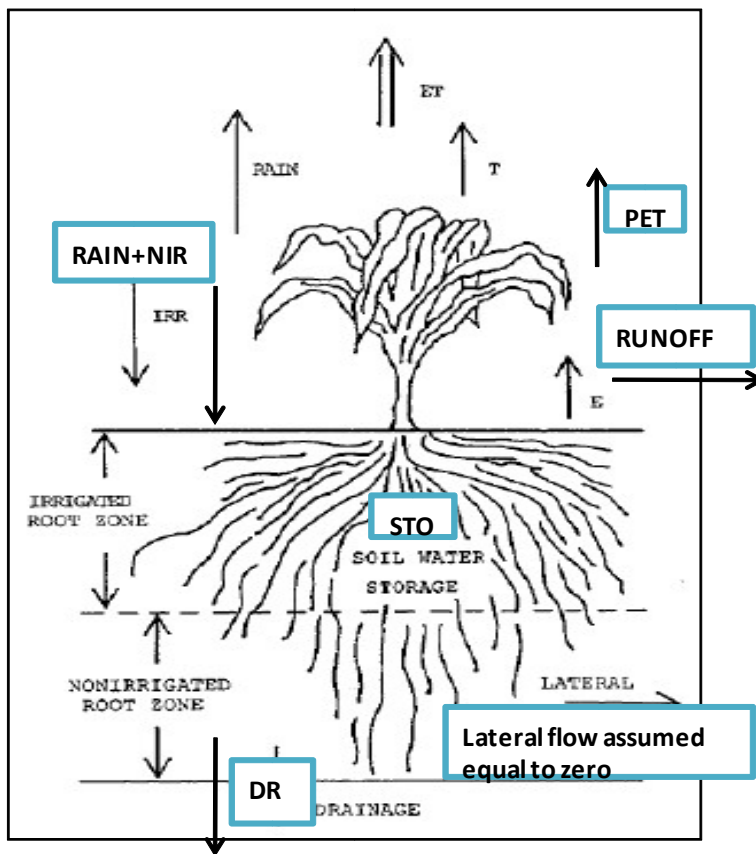

Figure 33. Illustration of parameters reflected in AFSIRS.

Within AFSIRS there are many parameters (beyond the growth rate parameters) that will be affected by climate change. For instance, climate change may cause soil to dry out, which can affect its storativity,

transmissivity, and discharge characteristics. This change has a very influential effect both in practice and in modeling on the infiltration and recharge and will therefore the effect the demand and supply of availability sources. However, these effects and consequences of these changes are hard to anticipate. For example, if soils dry out then as infiltration rates increase so too does the irrigation demand, which can increase the agricultural production costs and may result in a change of crop type. Therefore, it is not suggested that new models or additional parameter changes be applied to the proposed assessment due to the increased response uncertainty.

The FSAID 7, 8, and 9 reports highlight a few of the potential effects of how climate change may impact agricultural demand; however, these effects are not included in the final estimates and are therefore not suggested to be applied to the proposed assessment.

It is suggested that 50-year temperature, rainfall, and ET conditions at be applied to AFSIRS (See red boxes in Figure 32) and applied to 20-year acreages and expected crop types provided by FDACS. This reduces the need for additional model runs, eliminates the time needed to develop a new methodology, and provides a means for comparison to WSP model runs.

AG Withdrawal Rate Assumptions

There are several assumptions and uncertainties embedded within using AFSIRS as the AG withdrawal rate, some of which are as follows:

- All the assumptions represented in AFSIRS model and FDAC acreage and crop type are embedded.
- Climate change will not be reflected in the following AFSIRS input categories: crop data, Irrigation efficiency, soil data, land use data and runoff curve numbers.
- Climate changes will only be reflected in temperature, rainfall, and ET rates.

AG Demand Research

Below are relevant highlights from research conducted to supplement the workgroup's decision-making process.

- FSAID 7, 8, and 9 reports conducted future demand with climate change scenarios of Representative Concentration Pathway 4.5 and 8.5 and looked at the following: changes in ETo, rainfall, temperature, warm night (effects ET), frost freezes, intensification of hydrologic cycle, shorter cold season.
- Oregon's major demand assumption are the following: not to project crop differences, crops are irrigated properly, existing and future shortages were not considered, losses are in efficiency rate at 80% conveyance and 66% in application. Important conclusion factors: Early spring may affect specific crops, higher ET means higher consumption and demand, increased demands are expected to outpace increase precipitation even in wetter scenarios.
- Irrigation withdrawal is likely to increase because of climate change effects on agriculture produced in Middle America. This withdrawal is associated with increase temperature and will outpace the expected increase in precipitation.
- Ghait et al. does a thorough review of various ET models that can be applied to crops. Additionally, there are several alternate withdrawal rate methodologies that can be applied.

Landscape and Recreation Withdrawal Rate

Figure 34 shows the options presented to the workgroup based on research of the latest scientific methodology and strategies implemented by similar agencies.



Figure 34. Landscape and Recreation demand options.

In the 2018 LEC WSP, existing Landscape and Recreation (REC) demands were met by various surface water sources (39%), the Surficial Aquifer (32%), Reclaimed Water (27%), and the Floridan Aquifer (2%). REC demands are calculated only for areas with water use permits issued by the SFWMD. In 2018 REC withdrawal rates were calculated using AFSIRS for areas supplied by surface water sources, and the Surficial and Floridan Aquifers and using quantities submitted to the FDEP for areas supplied by reclaimed water. The 2023 withdrawal rates will use rates determined from annual water use reports. The exact methodology is still under development but will likely follow a similar approach to PS.

There are three types of irrigated landscaped areas outside of those permitted by the SFWMD that are excluded from the REC demands. The first type includes landscaped areas irrigated with potable water provided by PS utilities, which are accounted for under PS estimates and projections. The second type is irrigated single-family or duplex residential landscaped areas served by individual residential wells permitted by rule [Rule 40E-2.061, F.A.C.] or local stormwater pond, ditch, or canal rather than with an individual water use permit. Demands associated with these small, residential wells and surface water withdrawals are not quantified as part of the WSPs due to the lack of water use and acreage data. The third type of irrigated landscaped areas are those served with reclaimed water that do not require a water use permit. This usually occurs where reclaimed water is used directly from a pressurized pipeline or delivered into a lined or unlined lakes.

The vulnerability assessment will be conducted using only what can be incorporated into and simulated with the groundwater model. Therefore, it is suggested that future climate conditions be applied to the spatial data from REC acreages in WUPs. It should be noted that these demands will have growth rates based on the population growth rates.

REC Demand Assumptions

There are several assumptions and uncertainties embedded with using AFSIRS on spatially distributed REC demands, some of which are as follows:

- Irrigation demands embedded within PS PCUR don't incorporate climate change withdrawal rate changes.
- Irrigation demands without spatial components will not be included and may account for a significant portion of the total demand.
- Irrigation demands associated with small residential wells and those supported by reclaimed water will not be included as they are not directly incorporated into the groundwater model. Application of reclaimed water will be incorporated in the model simulations.
- Locations associated with a WUP will be based on population growth rates to 2075.

REC Demand Research

Below are relevant highlights from research conducted to supplement the workgroup's decision-making process.

- ASCE found that different plot types (single, multifamily, commercial) have a considerable effect on predictive demand because of increased lawns.

- “The effect of climate change on municipal and industrial water demand could be estimated through the evaluation of how the range of potential future climates would affect outdoor demands.”
- “Results show that groundwater pumping and recharge both will increase and that the effects of groundwater pumping will overshadow those from natural fluctuations. Groundwater levels will decline more in areas with irrigation-driven decreasing trends in the baseline.”

Industrial, Commercial, and Institutional Withdrawal Rate

Figure 35 shows the options presented to the workgroup based on research of the latest scientific methodology and strategies implemented by similar agencies.



Figure 35. Industrial, Commercial, and Institutional demand options.

In the 2018 LEC WSP, existing ICI demands were met by the surficial aquifer (38%), reclaimed water (35%), and various surface water sources (27%). Recirculated water used in closed-loop geothermal heating and cooling systems is not included in demand calculations. ICI projections assume demands for average rainfall years and 1-in-10-year drought conditions are the same and withdrawal demand is equal to user demand (no losses are assumed). The withdrawal rate for mining is connected to population growth and future demands are calculated accordingly.

Agriculturally focused ICI withdrawal rates such as those related to fruit cleaning will likely have impacts because of climate change; however, those impacts are too unpredictable and uncertain. For example, changes in withdrawal rates based on increasing processing efficiency will likely be inconsequential compared to those based on crop changes because of climate. Additionally, given that no additional business use cases are suggested to be segmented out and that drought conditions are accounted for in future climate conditions, it is suggested that the proposed assessment not deviate from the current WSP methodology.

ICI Withdrawal Rate Assumptions

There are several assumptions and uncertainties embedded within using existing WSP ICI withdrawal rate methodology, some of which are as follows:

- ICI withdrawal rate will not change because of climate change
- Demand rate associated with agricultural processing of different crop types and reductions to crop yield are not incorporated
- ICI demands include only those defined by the WSP and not business use cases incorporated into PS
- Future improvements to processing efficiency will not be incorporated
- ICI mining withdrawal rates will be applied to future population growth

Power Withdrawal Rate

Figure 36 shows the options presented to the workgroup based on research of the latest scientific methodology and strategies implemented by similar agencies.



Figure 36. Power withdrawal rate options.

In the 2018 LEC WSP, existing Power (PWR) demands were met by Reclaimed Water (69%) and the Floridan Aquifer (31%). PWR demands do not include the use of brackish surface water and cooling water returned to its withdrawal source, or seawater. Demands under average rainfall and 1-in-10-year drought conditions are assumed to be equal for the PWR category, and no distinction is made between net and gross water demands. Baseline demands are estimated using utility-required reported water use. Additional demands are added on a case-by-case basis and projecting future demand based on climate change is not feasible. Additionally, increased power generation will likely be the result of renewables that require less demand such as solar power. Therefore, it is suggested that the proposed assessment apply existing WSP methodologies.

- Power water supply withdrawal rates will not include the effects of climate change

Domestic Self Supply Withdrawal Rate

Figure 37 shows the options presented to the workgroup based on research of the latest scientific methodology and strategies implemented by similar agencies.



Figure 37. Domestic Self Supply withdrawal rate options.

Domestic Self Supply (DSS) demand accounts for 1% of total water supply demands in the LEC. It is delineated in the WSP as potable water used by households served by small utilities (less than 0.10 mgd) or self-supplied by private wells. The WSP applied the same PCUR to both PS and DSS. It is suggested that the same methodology used in WSP be applied to DSS in the proposed assessment. (See discussion in PS Growth Rate and Withdrawal Rate and DSS Growth Rate)

All PS PCUR assumptions apply.

Page intentionally left blank.

Page intentionally left blank.

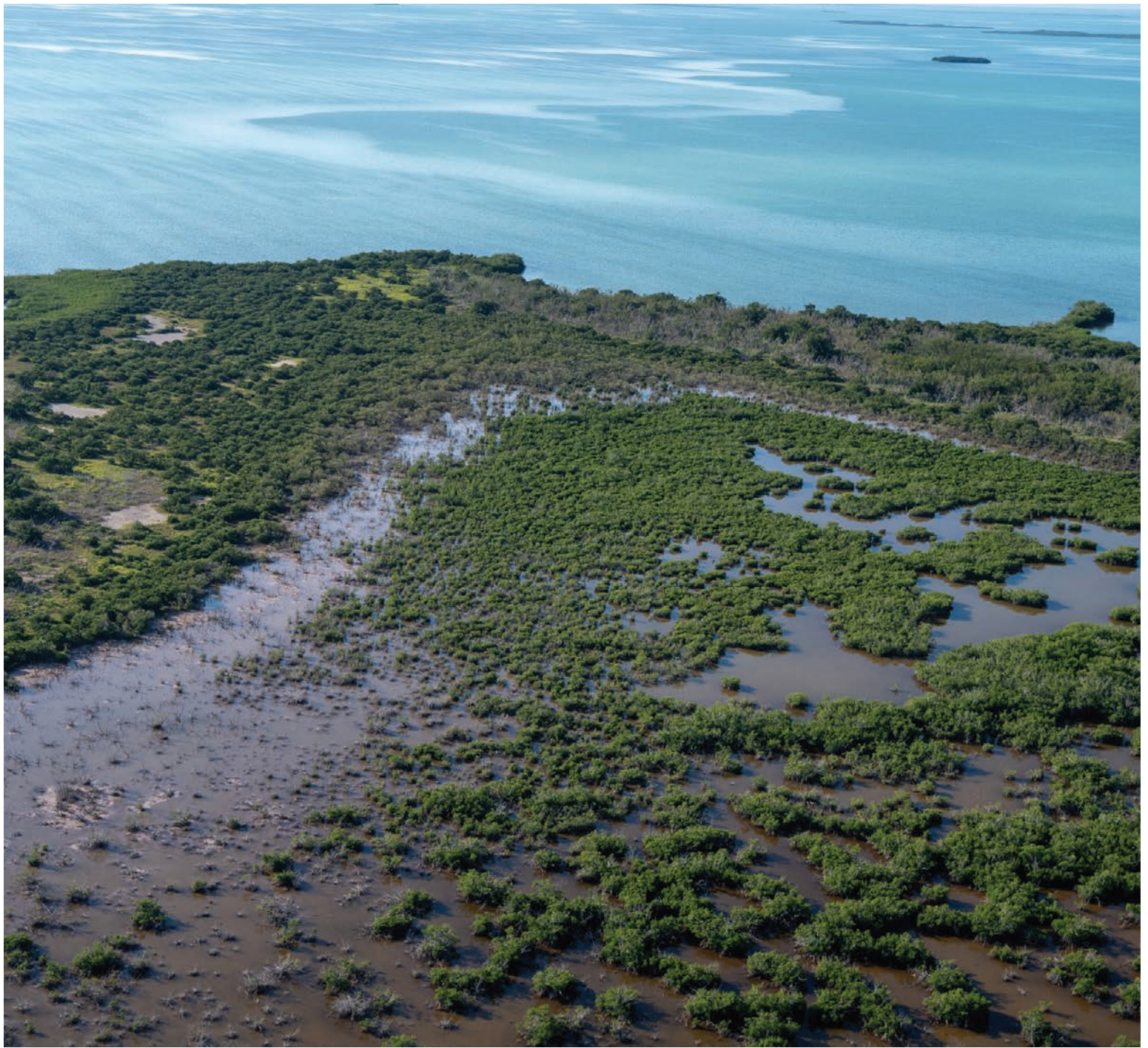

Ron DeSantis, Governor

SFWMD Governing Board

Chauncey Goss, Chairman
Scott Wagner, Vice Chairman
Ron Bergeron Sr.
Ben Butler
Charlie E. Martinez
Cheryl Meads
Charlette Roman
Jay Steinle

Shawn Hamilton, Secretary,
Florida Department of
Environmental Protection

SFWMD Executive Management

Drew Bartlett, Executive Director
John Mitnik, Asst. Executive Director & Chief Engineer
Sean Cooley, Chief Communications & Public Policy Officer
Jill Creech, Regulation Director
Lucine Dadrian, Engineering, Construction, & Modeling Director
Maricruz Fincher, General Counsel
Lawrence Glenn, Water Resources Director
Candida Heater, Administrative Services Director
Lisa Koehler, Big Cypress Basin Administrator
Dr. Carolina Maran, Chief of District Resiliency
Duane Piper, Chief Information Officer
Jennifer Reynolds, Ecosystem Restoration Director
Jennifer Smith, Chief of Staff
Rich Virgil, Field Operations Director

Get the latest information from SFWMD

Learn more about resiliency in South Florida
by signing up for the District's emails.
Visit SFWMD.gov and click on *"Subscribe for Email Updates."*

Connect with us on Facebook, Twitter,
Instagram, LinkedIn and YouTube.



3301 Gun Club Road
West Palm Beach, FL 33406
SFWMD.gov/resiliency
resiliency@sfwmd.gov