
ANNEX A-1
Hydraulic Design

- A-1.1 Hydraulic Modeling and Calculations
- A-1.2 Horsepower Calculations for Pump Stations

ANNEX A-1.1 HYDRAULIC MODELING AND CALCULATIONS

Existing and proposed canals and structures referred to in **Annex A-1.1** are shown on the LOCAR Overall Site Plan for the Recommended Plan included in **Annex C-1**. Cross-section drawings of the proposed canals and structures are included in **Annex C-1**.

1.0 Preliminary HECRAS Canal Conveyance Assessments

The Corps' HECRAS 6.3.1 software program was used to assess the canal conveyance of the existing and proposed canals in the LOCAR Project. Canals were modeled with a Manning's n value of 0.03 for clean, straight channels, full, no rifts or deep pools. Losses in the canals were calculated using steady state calculations. Tailwater elevations were estimated used SFWMD's DBHYRO database.

1.1 Existing Canals Conveyance

1.1.1 C-38 Canal Conveyance Modeling from S-65E to Lake Okeechobee for PS-1 Maximum Pumping Rate Scenario

Flow conveyance from Lake Okeechobee to S-84+/PS-1 through the C-38 and C-41A canals was modeled using HEC-RAS. This modeling assesses channel losses and restriction caused by back pumping 1,500 cfs through the C-38 canal downstream of structure S-65E. **Figure A-1.1-1** shows the extent of the C-38 Canal included in the simulation. Available record cross-sections from the Corps survey, and structure record drawings were used to develop the model. Simulations considered the low water level in Lake Okeechobee of 10.25 ft NAVD88. S-65EW was inputted in accordance with the record drawings for this structure, by Wantman Group, dated 9/25/2008, which show that S-65EW includes an upstream sheetpile wall weir with a crest length of 202 ft and an average crest elevation of -0.6 ft NAVD88 (0.6 ft NGVD29), and a downstream sheetpile wall weir with a crest length of 203 ft and an average crest elevation of -12.5 ft NAVD88 (-11.3 ft NGVD29). Model simulation results are presented in **Figure A-1.1-2** and **Tables A-1.1-1 and A-1.1-2**. The results indicate any restrictions and channel losses were negligible for the proposed back pumping.

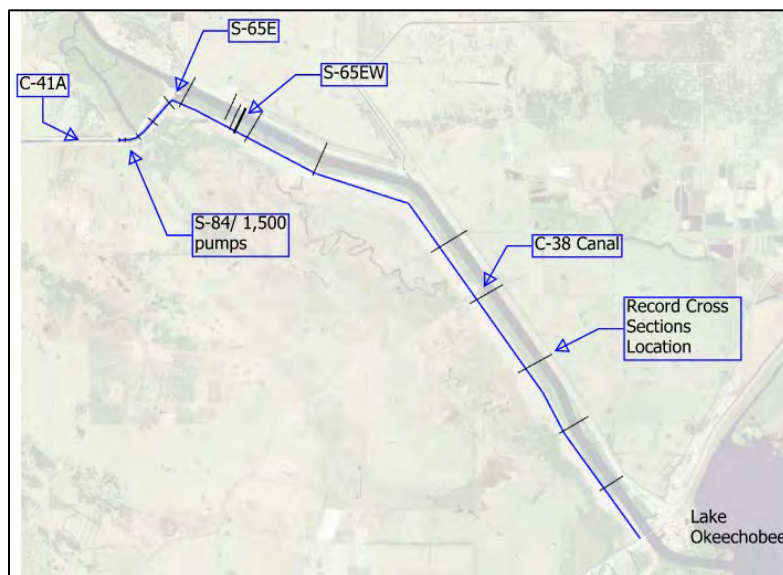


Figure A-1.1-1. C-38 Canal assessed with HECRAS.

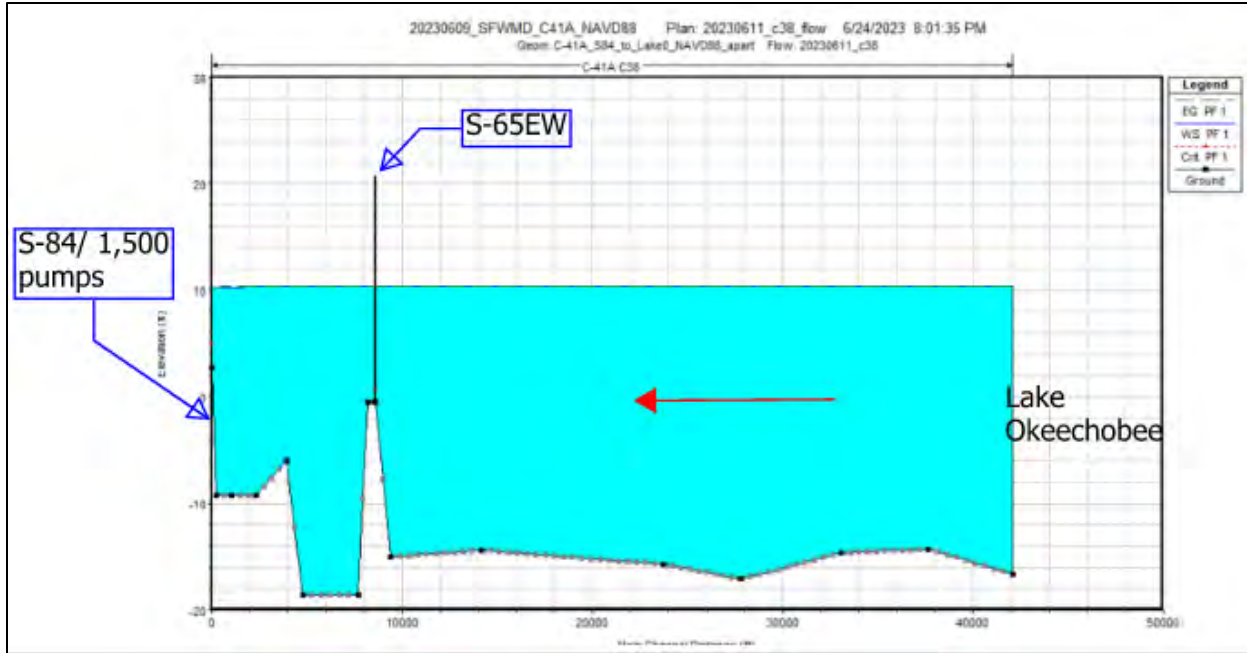


Figure A-1.1-2. C-38 Canal water surface profile based on 1,500 cfs from Lake to S-84.

Table A-1.1-1 HECRAS results for C-38.

Reach	River Sta	Q Total (cfs)	Min Ch El (ft)	W.S. Elev (ft)	Crit W.S. (ft)	E.G. Elev (ft)	E.G. Slope (ft/ft)	Vel Chnl (ft/s)	Flow Area (sq ft)	Top Width (ft)	Froude # Chl
C38	42067	1500.00	-16.60	10.39		10.39	0.000000	0.12	12657.73	597.03	0.00
C38	37669	1500.00	-14.30	10.39		10.39	0.000000	0.12	12081.39	571.60	0.00
C38	33101	1500.00	-14.60	10.39		10.39	0.000000	0.13	11657.79	533.69	0.00
C38	27803	1500.00	-17.10	10.39		10.39	0.000000	0.12	12771.94	548.78	0.00
C38	23761	1500.00	-15.70	10.38		10.39	0.000000	0.12	12551.40	610.66	0.00
C38	14157	1500.00	-14.40	10.38		10.38	0.000000	0.12	12610.18	766.86	0.00
C38	9401	1500.00	-15.00	10.38		10.38	0.000000	0.12	12182.82	585.79	0.00
C38	8604	1500.00	-0.45	10.37	0.75	10.38	0.000011	0.69	2165.30	200.10	0.04
C38	8412	Inl Struct									
C38	8192	1500.00	-0.45	10.36		10.37	0.000011	0.69	2163.37	200.10	0.04
C38	7671	1500.00	-18.60	10.37		10.37	0.000000	0.09	16683.60	849.95	0.00
C38	4766	1500.00	-18.60	10.37		10.37	0.000000	0.09	16683.41	849.94	0.00
C38	3907	1500.00	-6.00	10.36		10.37	0.000009	0.62	2420.13	243.62	0.03
C38	2348	1500.00	-9.20	10.34		10.35	0.000009	0.81	1842.53	108.57	0.03
C38	1049	1500.00	-9.20	10.33		10.34	0.000009	0.81	1841.21	108.55	0.03
C38	200	1500.00	-9.20	10.32		10.33	0.000011	0.82	1840.29	108.54	0.03
C38	100	1500.00	2.80	10.25	4.97	10.32	0.000217	2.12	707.01	109.80	0.15

Table A-1.1-2. HECRAS results for S-65EW.

Reach	River Sta	E.G. Elev (ft)	W.S. Elev (ft)	Q Total (cfs)	Q Weir (cfs)	Q Gates (cfs)	Q Culv (cfs)	Q Inline RC (cfs)	Q Outlet TS (cfs)	Q Breach (cfs)
C38	8412	10.38	10.37	1500.00		1500.00				0.00

1.1.2 C-41A Canal Conveyance Modeling from S-83 to S-84 for PS-2 Maximum Pumping Rate Scenario

Back pumping from S-84+ to the PS-2 pump station was simulated to assess the channel losses in the C-41A canal using HEC-RAS. **Figure A-1.1-3** shows the extent of the C-41A canal included in the simulation. To model this scenario, Corps record drawings for the C-41A canal were coded into the software. Simulation was conducted using a flow rate of 1,500 cfs, from S-84 to the LOCAR East Cell. This simulation is based on the simultaneous operation of pump stations PS-1 and PS-2 (to be constructed as part of the Recommended Plan), both pumping at their maximum design rate of 1,500 cfs. In the simulation, PS-1 is located at S-84, and pumps water from the tailwater side of S-84 to the headwater side of S-84, while PS-2 located near the southeast corner of the reservoir, pumps water from C-41A into the reservoir East Cell. The tailwater stage at S-83 in the model, was set to S-83's historical low tailwater stage of 21.6.

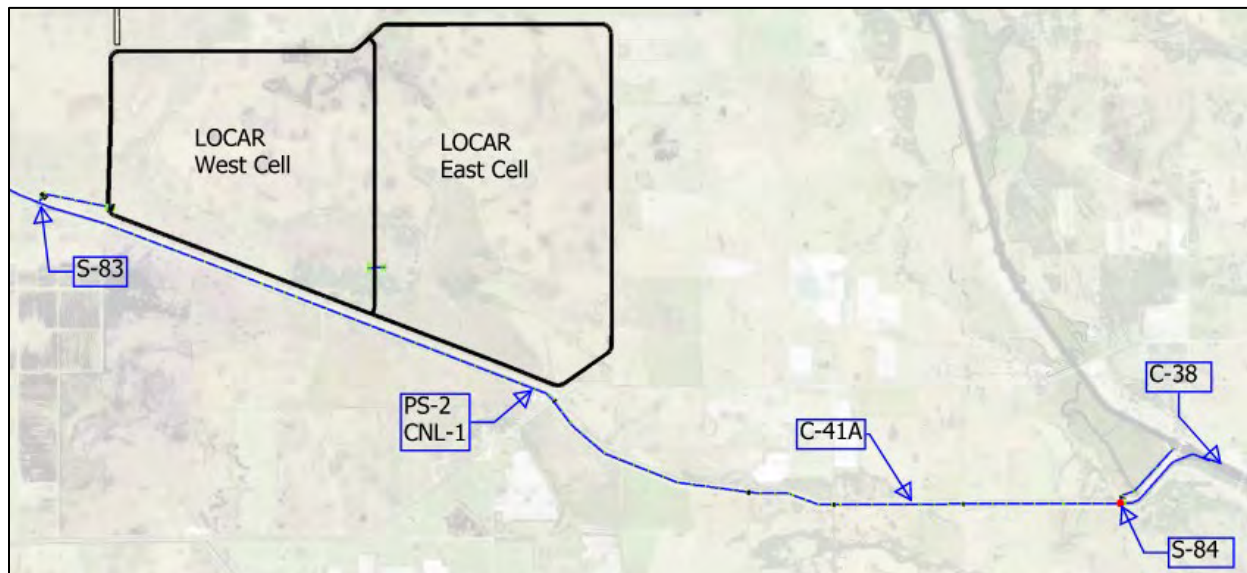


Figure A-1.1-3. C-41A backflow canal assessed with HECRAS.

Results from this simulation are presented in **Figure A-1.1.4** and **Table A-1.1-3** and show that the back pumping can be accomplished with minimal losses. As a comparison the C-41A was designed to handle discharge rates in excess of 5,000 cfs.

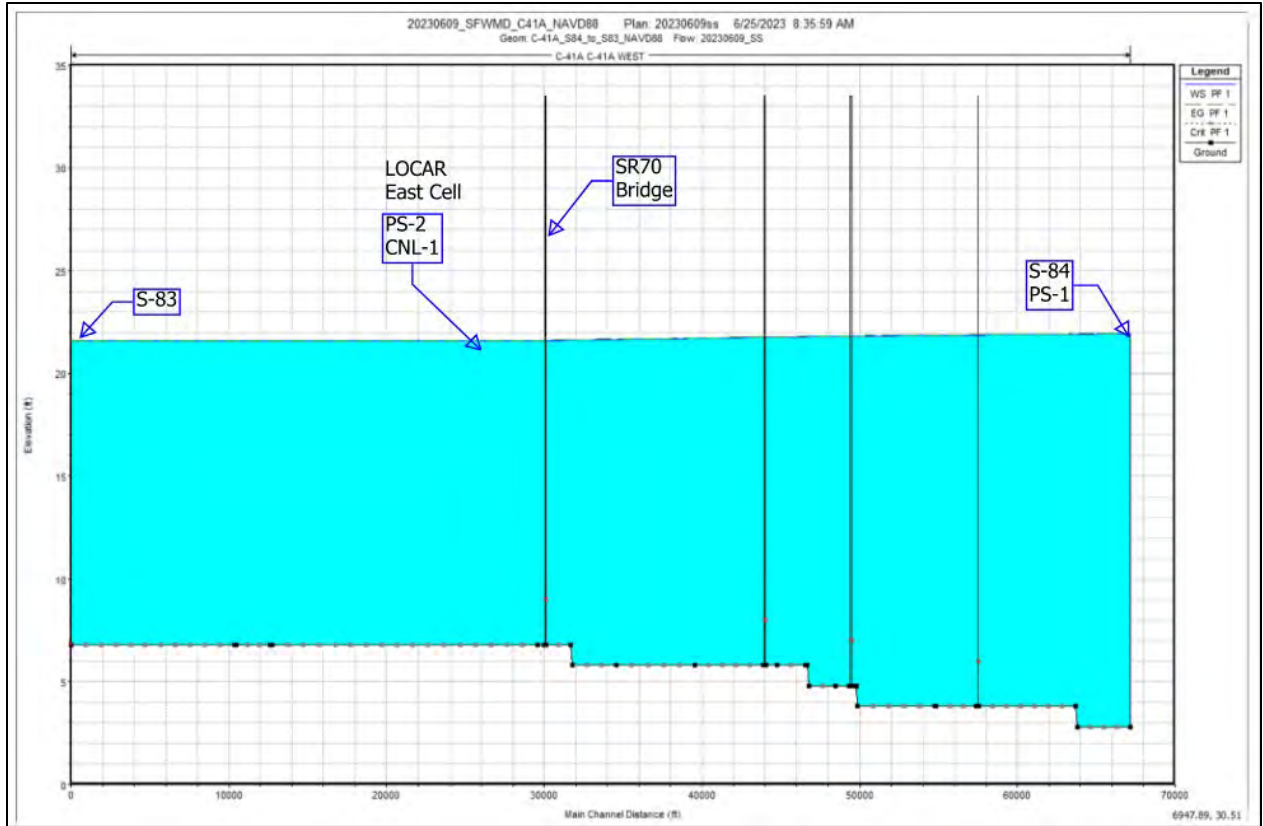


Figure A-1.1-4. C-41A Canal backflow profile.

Table A-1.1-3. C-41A Canal backflow assessed with HECRAS.

HEC-RAS Plan: SS3 River: C-41A Reach: C-41A WEST Profile: PF 1											
Reach	River Sta	Q Total (cfs)	Min Ch El (ft)	W.S. Elev (ft)	Crit W.S. (ft)	E.G. Elev (ft)	E.G. Slope (ft/ft)	Vel Chnl (ft/s)	Flow Area (sq ft)	Top Width (ft)	Froude # Chl
C-41A WEST	107076	1500.00	2.80	21.93		21.94	0.000005	0.66	2262.64	156.53	0.03
C-41A WEST	107075.8	1500.00	2.80	21.93		21.94	0.000005	0.66	2262.63	156.53	0.03
C-41A WEST	103727.7	1500.00	2.80	21.91		21.92	0.000006	0.66	2259.75	156.45	0.03
C-41A WEST	103623	1500.00	3.80	21.91		21.92	0.000007	0.71	2105.02	152.45	0.03
C-41A WEST	97496	1500.00	3.80	21.87	5.97	21.88	0.000007	0.71	2098.71	152.28	0.03
C-41A WEST	97398	Bridge									
C-41A WEST	97329	1500.00	3.80	21.87		21.88	0.000007	0.71	2098.39	152.27	0.03
C-41A WEST	94787	1500.00	3.80	21.85		21.86	0.000007	0.72	2095.76	152.20	0.03
C-41A WEST	94689	1500.00	3.80	21.85		21.86	0.000007	0.72	2095.65	152.20	0.03
C-41A WEST	89813	1500.00	3.80	21.82		21.82	0.000007	0.72	2090.58	152.07	0.03
C-41A WEST	89732	1500.00	4.80	21.81		21.82	0.000008	0.77	1940.21	148.06	0.04
C-41A WEST	89472	1500.00	4.80	21.81	6.97	21.82	0.000008	0.77	1939.89	148.05	0.04
C-41A WEST	89381.69	Bridge									
C-41A WEST	89272	1500.00	4.80	21.81		21.82	0.000008	0.77	1939.38	148.04	0.04
C-41A WEST	88416	1500.00	4.80	21.80		21.81	0.000008	0.77	1938.30	148.01	0.04
C-41A WEST	86715	1500.00	4.80	21.79		21.80	0.000009	0.77	1936.16	147.95	0.04
C-41A WEST	86629	1500.00	5.80	21.79		21.80	0.000011	0.84	1789.84	143.94	0.04
C-41A WEST	86484	1500.00	5.80	21.78		21.79	0.000011	0.84	1789.62	143.93	0.04
C-41A WEST	84680	1500.00	5.80	21.76		21.78	0.000011	0.84	1786.84	143.86	0.04
C-41A WEST	84002	1500.00	5.80	21.76	7.97	21.77	0.000011	0.84	1785.80	143.83	0.04
C-41A WEST	83909.20	Bridge									
C-41A WEST	83825	1500.00	5.80	21.75		21.76	0.000011	0.84	1785.25	143.81	0.04
C-41A WEST	79470	1500.00	5.80	21.71		21.72	0.000011	0.84	1778.49	143.62	0.04
C-41A WEST	74522	1500.00	5.80	21.65		21.66	0.000011	0.85	1770.73	143.41	0.04
C-41A WEST	71736	1500.00	5.80	21.62		21.63	0.000011	0.85	1766.33	143.29	0.04
C-41A WEST	71622	1500.00	6.80	21.62		21.63	0.000014	0.92	1624.54	139.27	0.05
C-41A WEST	70068	1500.00	6.80	21.60	8.97	21.61	0.000014	0.93	1621.49	139.18	0.05
C-41A WEST	69982.92	Bridge									
C-41A WEST	69925	1500.00	6.80	21.59		21.61	0.000014	0.93	1620.98	139.17	0.05
C-41A WEST	69529	1.00	6.80	21.60		21.60	0.000000	0.00	1622.08	139.20	0.00
C-41A WEST	52680	1.00	6.80	21.60		21.60	0.000000	0.00	1622.08	139.20	0.00
C-41A WEST	52577	1.00	6.80	21.60		21.60	0.000000	0.00	1474.08	129.20	0.00
C-41A WEST	50410	1.00	6.80	21.60		21.60	0.000000	0.00	1474.08	129.20	0.00
C-41A WEST	50298	1.00	6.80	21.60		21.60	0.000000	0.00	1326.08	119.20	0.00
C-41A WEST	39933	1.00	6.80	21.60	6.83	21.60	0.000000	0.00	1326.08	119.20	0.00

1.1.3 C-38 Canal Conveyance Modeling from S-65E to Lake Okeechobee for Maximum Discharge Rate Scenario

Flow conveyance from S-84+ and S-65E to Lake Okeechobee through the C-41A and C-38 canals was modeled using HEC-RAS, for the condition when S-84+ and S-65E are simultaneously discharging at their maximum design rates (which are their Standard Project Flood [SPF] peak discharge rates) of 9,000 cfs and 24,000 cfs, respectively; and S-65EX1 is simultaneously discharging at its SPF peak discharge rate of 13,000 cfs (S-65EX1’s maximum design discharge rate is 12,000 cfs). This modeling assesses channel losses and restriction in C-41A and C-38 when the combined SPF peak discharge from these structures flows through C-38 to Lake Okeechobee.

A steady state model was used for this evaluation, with the C-41A Canal modeled from the S-83 structure to the C-38 Canal confluence, and the C-38 Canal modeled from the S-65E structure to Lake Okeechobee. Record Drawings for C-41A and C-38 were used for the model. See **Figure A-1.1-5** for model limits. Model

includes a tailwater stage of 18.0 feet NAVD88 in Lake Okeechobee for the SPF event, which matches the Lake Okeechobee stage used in the dam breach model simulations for the 100-yr storm and PMP events, as described in Section 4.5 of **Annex A-2.7**. A stage of 18 feet NAVD88 was chosen as the tailwater conditions based on the tailwater used in the previous modeling of the dam breach, documented in Annex A-2.7 of the LOCAR Section 203 Feasibility Study report. Canal flows rate through C-41A and C-38 canal are shown in **Table A-1.1-4**. C-41A flows in the model were based on the SPF flows used in the Corps design report for the C-41A Canal, titled Central and Southern Florida Project For Flood Control and Other Purposes, Part II, Kissimmee River Basin and Related Areas, Supplement 7 – Detail Design Memorandum Canal C-41A (Slough and Stub Canals) Structures 66, 68, 83 and 84, Serial No. 22, dated January 22, 1958.

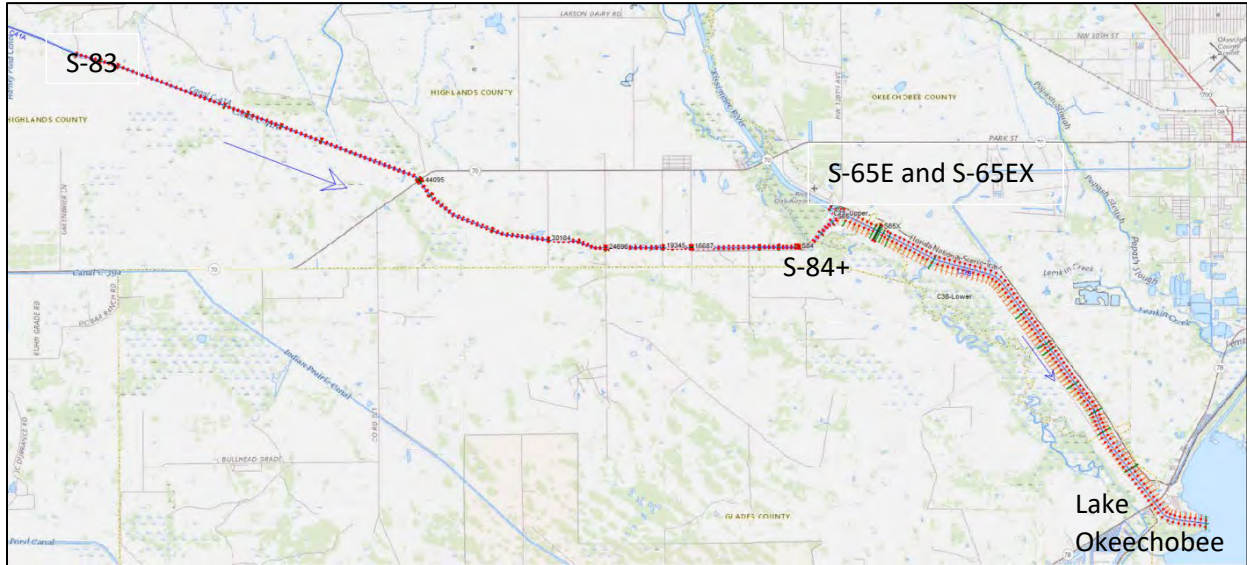


Figure A-1.1-5. Model Limits from S-83 to S-84+ and S-65E to Lake Okeechobee.

The model includes the revised S-84+ Structure, which consists of three, 22 feet wide gates. Each gate opening includes an ogee weir with a crest elevation of 12 feet NAVD88. Gates were fully open for the model run.

Table A-1.1-4. C-41A and C-38 Canal flow rates in cubic feet per second for each tailwater condition.

Flow Change Location				
	River	Reach	RS	PF 1
1	C38	C38_Upper	49124	37000
2	C38	C38-Lower	47300.72	46000
3	C41A	C41A	78350	4150
4	C41A	C41A	64663.6*	5000
5	C41A	C41A	57512.5*	5750
6	C41A	C41A	51572.2*	6500
7	C41A	C41A	45745.6*	7150
8	C41A	C41A	41821.4*	7600
9	C41A	C41A	37992.8*	8000
10	C41A	C41A	34067.0*	8150
11	C41A	C41A	24800	8300
12	C41A	C41A	19235	8500
13	C41A	C41A	17216.0*	8600
14	C41A	C41A	13683.5*	8700
15	C41A	C41A	7268.00*	9000

Simulation results are shown in the water surface profile for C-41A in **Figure A-1.1-6** and the water surface profile for C-38 in **Figure A-1.1-7**. In each of these figures, the approximate top of the levee and the top of the maintenance bench on each side of the canal is shown. The LOB and ROB profile lines represent the approximate top of the maintenance bench on the left and right sides of the canals, respectively. The LTL and RTL profile lines represent the approximate top of the levee on the left and right sides of the canals, respectively. Simulation results for C-41A and C-38 are shown in **Table A-1.1-5**.

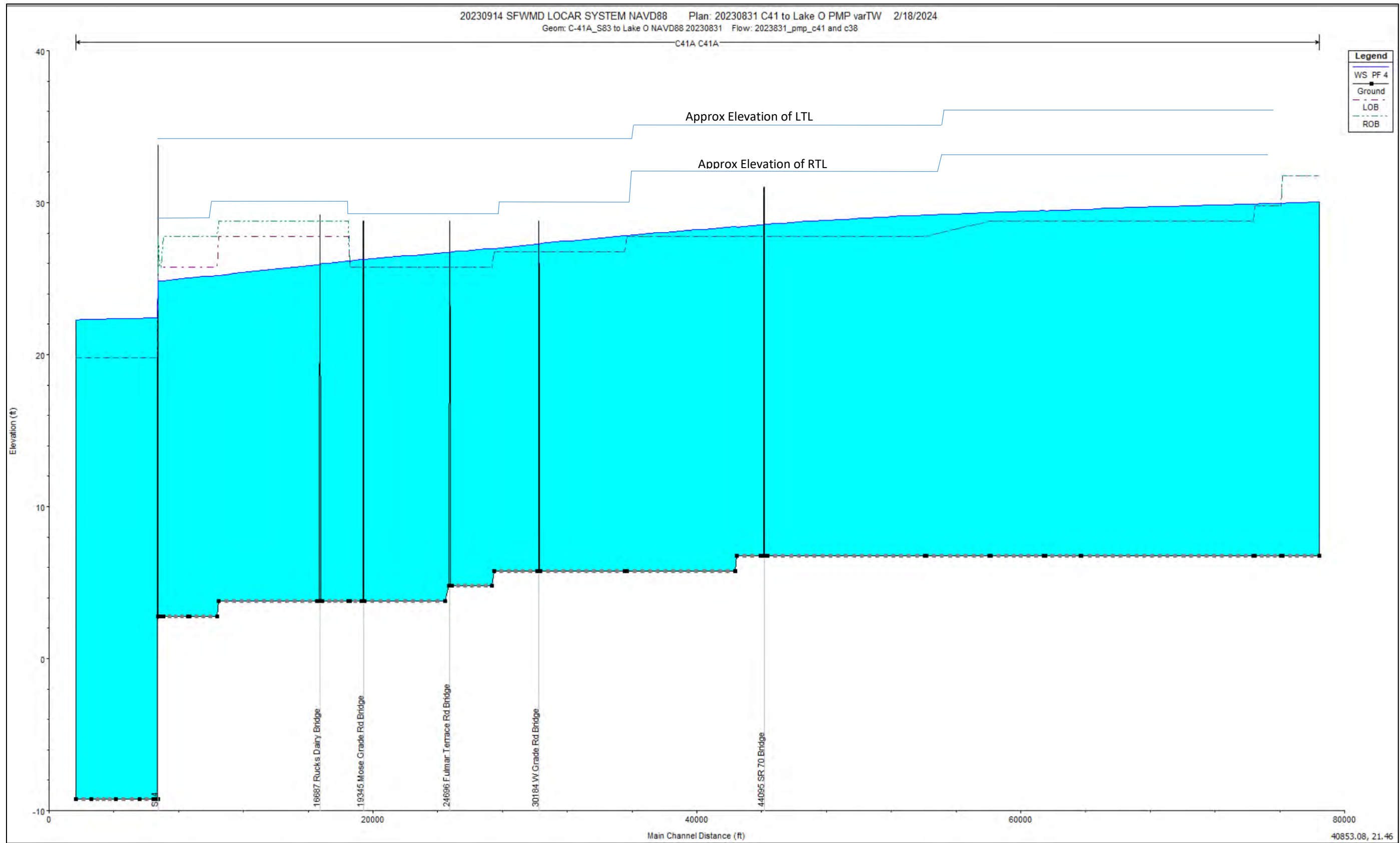


Figure A-1.1-6. C-41A Canal water surface profile.

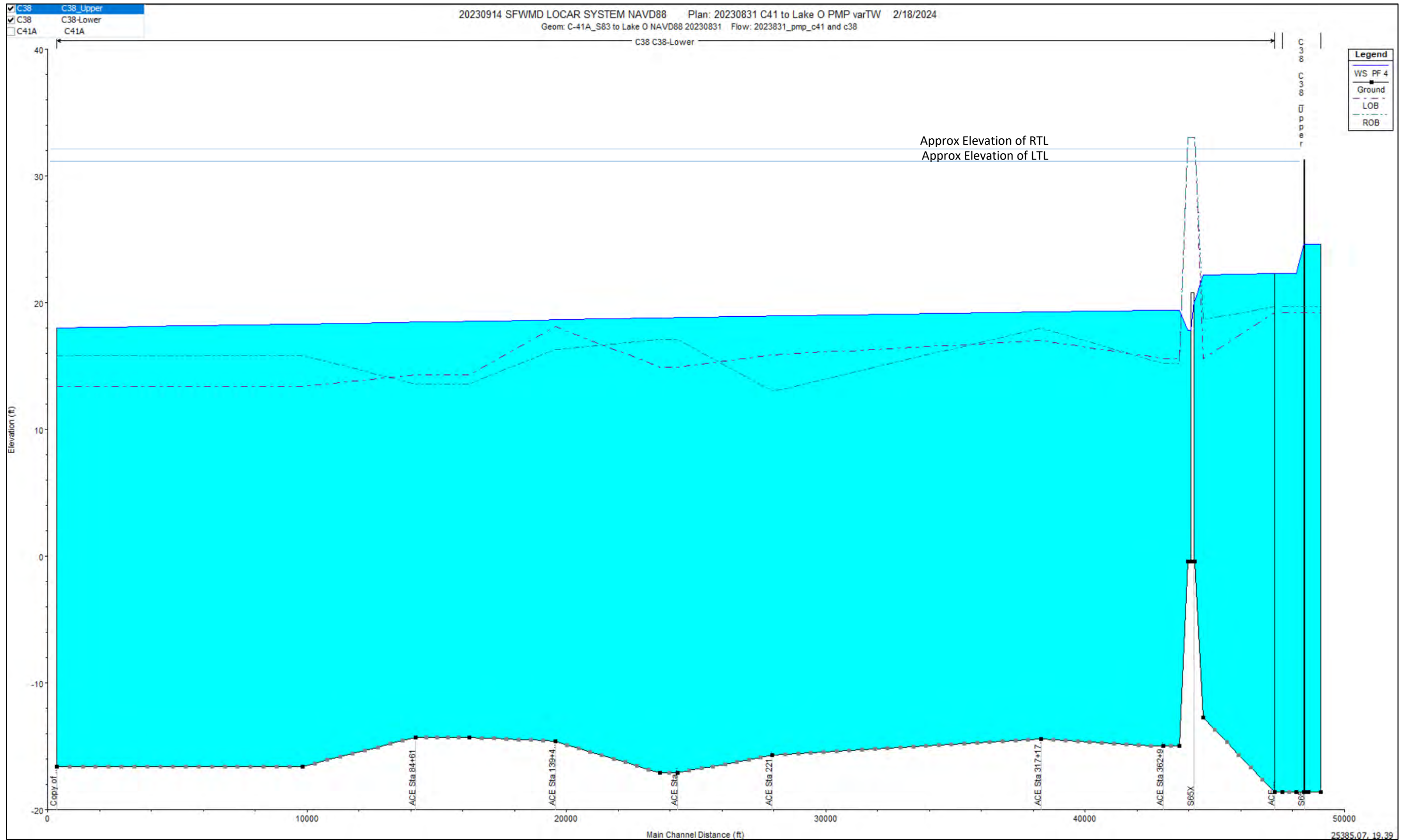


Figure A-1.1-7. C-38 Canal water surface profile with Lake Okeechobee at 18.0 feet NAVD88.

Table A-1.1-5. C-41A and C-38 Canal water surface profile and flow.

River	Reach	River Sta	Q Total (cfs)	Min Ch El (ft)	W.S. Elev (ft)	Crit W.S. (ft)	E.G. Elev (ft)	E.G. Slope (ft/ft)	Vel Chnl (ft/s)	Flow Area (sq ft)	Top Width (ft)	Froude # Chl
C41A	C41A	78350	4150.00	6.78	30.97		31.01	0.000026	1.58	2621.83	156.76	0.07
C41A	C41A	63700	5000.00	6.78	30.56		30.62	0.000038	1.94	2703.71	237.91	0.08
C41A	C41A	54100	5750.00	6.78	30.27		30.33	0.000034	1.91	3187.48	257.96	0.08
C41A	C41A	44289	7150.00	6.78	29.80		29.89	0.000057	2.44	3112.27	301.60	0.10
C41A	C41A	35600	8000.00	5.78	29.22		29.33	0.000069	2.68	3114.19	288.17	0.11
C41A	C41A	30246	8150.00	5.78	28.83		28.95	0.000074	2.78	3123.57	302.67	0.12
C41A	C41A	24800	8300.00	4.78	28.44		28.55	0.000068	2.72	3312.08	319.96	0.11
C41A	C41A	16821	8600.00	3.78	27.90		28.02	0.000075	2.78	3097.27	218.33	0.12
C41A	C41A	10400	8700.00	3.78	27.34		27.47	0.000084	2.90	2995.63	174.26	0.12
C41A	C41A	6857	9000.00	2.78	27.10		27.22	0.000078	2.87	3210.68	263.31	0.12
C41A	C41A	6710	9000.00	2.78	27.07	9.67	27.20	0.000078	2.88	3175.89	218.46	0.12
C41A	C41A	6571	9000.00	-9.22	22.42		22.48	0.000026	1.97	4751.59	291.00	0.07
C41A	C41A	1679	9000.00	-9.22	22.29		22.35	0.000027	1.99	4713.33	290.25	0.07
C38	C38-Lower	47300.72	46000.00	-18.60	22.30		22.34	0.000012	1.67	29178.69	1479.52	0.05
C38	C38-Lower	44230	46000.00	-0.45	20.13	11.34	22.07	0.001156	11.17	4118.36	200.19	0.43
C38	C38-Lower	43639	46000.00	-15.00	19.42		19.52	0.000031	2.55	19290.52	1161.30	0.08
C38	C38-Lower	9820	46000.00	-16.60	18.32		18.42	0.000032	2.55	19587.68	1203.69	0.09
C38	C38-Lower	357	46000.00	-16.60	18.00	-7.75	18.10	0.000034	2.59	19208.58	1188.54	0.09

Model results for SPF flows through C-41A and C-38, with the Lake Okeechobee stage at 18.0 feet NAVD88, show some flow on top of the maintenance benches, with average cross-sectional flow velocities less than 3.0 feet per second for the C-41A and C-38 canals, with the exception of the flow velocity through the S-65EW fixed weir structure. As shown in **Figures A-1.1-6** and **A-1.1-7** the levees on each side of the C-41A and C-38 canals were not overtopped in this simulation with SPF flows through these canals. The Corps computation in 1958 used a 2-gated structure at S-84, that raised stages upstream of the structure. Structure S-84+ is proposed to be an improvement from S-84, since it will be a 3-gated structure. With the addition of a third gate, stages in the canal were modelled lower than the 1958 estimate.

1.2 Proposed Canals Conveyance

1.2.1 CNL-1 Reservoir Perimeter Canal

Based on the existing topography of the reservoir site, and the control elevations recommended for CNL-1 in **Section A.9**, CNL-1 will have two cascading flow paths, as shown in the LOCAR Overall Site Plan (in **Annex C-1**), which include:

- Western Flow Path: Reach 2B to Reach 7
- Eastern Flow Path: Reach 3A to Reach 7

The greatest amount of stormwater and seepage flow will be conveyed along the western flow path of CNL-1. CNL-1 was sized so that its flow velocity would be less than 1.5 ft/sec when conveying combined seepage flows and stormwater flows. Based on the 3D seepage modeling described in **Section A.9**, the maximum seepage flow through the canal is estimated to be 14.7 cfs (would occur during the wet season for seepage collected in CNL-1, flowing in a cascading fashion along its western flow path).

Hydrologic and Hydraulic modeling was done to simulate simultaneous conveyance of seepage flows and stormwater flows (from onsite and offsite runoff) through the reservoir perimeter canal (CNL-1) to the C-41A canal (via the existing project culverts and proposed reservoir perimeter canal (CNL-1) overflow structures located along the LOCAR's southwest side). This modeling is documented in **Annex A-2.6**.

1.2.2 CNL-2 Reservoir East Inflow-Outflow Canal

CNL-2 was sized based on the pump intake bay width required for PS-2, which includes four pump intake bays, that each direct flow to a 375 cfs pump. Based on the information provided by the pump manufacturer, a 375 cfs pump will have an impeller diameter of 66.2 inch and bell diameter of 108 inches. The Hydraulic Institute (HI) recommends two times the bell diameter for the pump bay width. Following this recommendation, each bay would have a width of $(108 \text{ in}) \times 2 = 216 \text{ in}$ (18 ft). However, for the conceptual design of PS-2, it was decided to model the design after the recently constructed SFWMD S-470 Pump Station, which like PS-2, has four pump intake bays, that each direct flow to a 375 cfs pump. The four pump intake bays for S-470 are each 24-ft-wide, with 3-ft-wide bay divider walls. Therefore, CNL-1 will need to have a bottom width of 105 ft to match the total width of the PS-2 pump intake bays and divider walls. CNL-2 bottom elevation will match the C-41A bottom elevation of 6.8 ft NAVD88, and then transition at a slope of 10 degrees to the pump bay inverts of (-) 2.1 ft NAVD88. Canal area is 2,211 square ft (ft^2), based on its bottom elevation of 6.8 ft NAVD88, a stage of 21.6 ft NAVD88 in the canal, bottom width of 105 ft, and 3H:1V side slopes. Therefore, the maximum design flow velocity of CNL-2 which occurs at the location where its cross-sectional area is smallest, when conveying the PS-2 maximum pumping rate of 1,500 cfs, or conversely when conveying the maximum CU-1B or PCOS-2 maximum outflow rate of 1,500 cfs, will be 0.68 ft/sec.

1.2.3 CNL-3 Reservoir West Outflow Canal

CNL-3 was sized to ensure that the flow velocity in the canal would be less than 1.5 ft/sec when conveying the maximum outflow from CU-2 of 1,500 cfs. Canal area is 2,516 ft^2 , based on its bottom elevation of 8.8 ft NAVD88, a stage of 30.6 ft NAVD88 in the canal (based on the normal low headwater operating stage for S-83), bottom width of 50 ft, and 3H:1V side slopes. Therefore, the maximum design flow velocity of CNL-3, which occurs when conveying the maximum CU-2 outflow of 1,500 cfs, will be 0.60 ft/sec.

The dimensions of the proposed improvements were coded into HEC-RAS to determine the overall system operation at low water levels in the reservoir. **Figure A-1.1-5** shows the extent of CNL-3 included in the simulation.

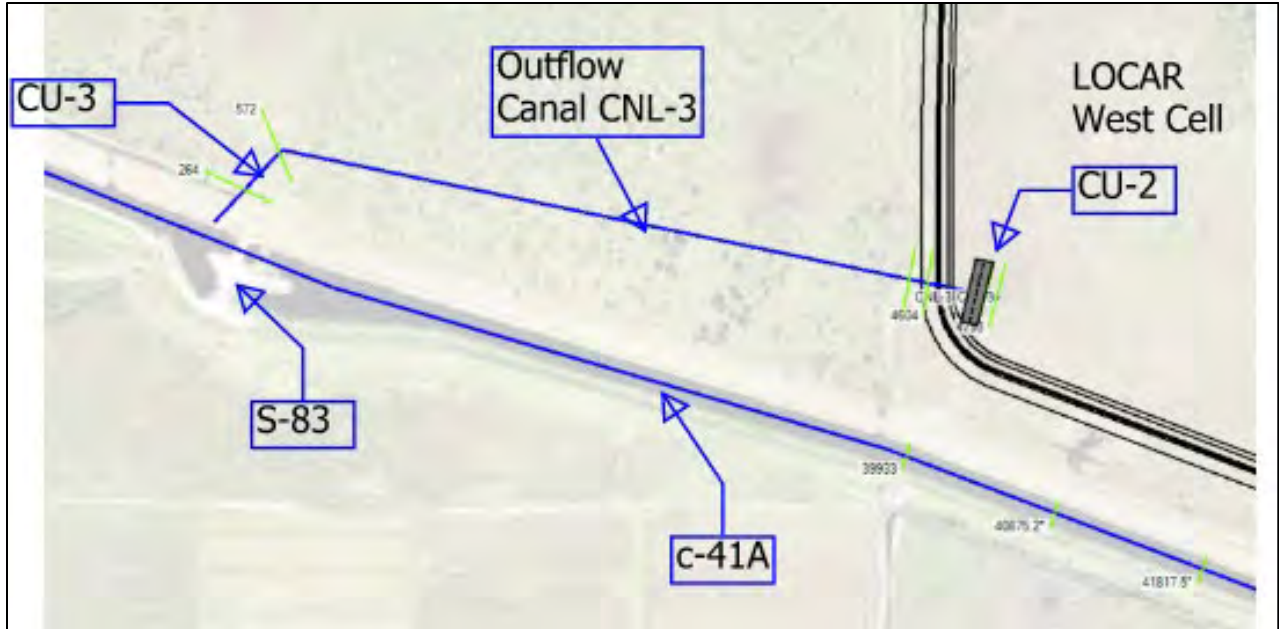


Figure A-1.1-5. CNL-3 Canal limits.

Data presented in **Figures A-1.1-6** and **A-1.1-7**, and **Tables A-1.1-4**, **A-1.1-5** and **A-1.1-6** are the results of this simulation and indicate the channel velocity and structure losses are acceptable.

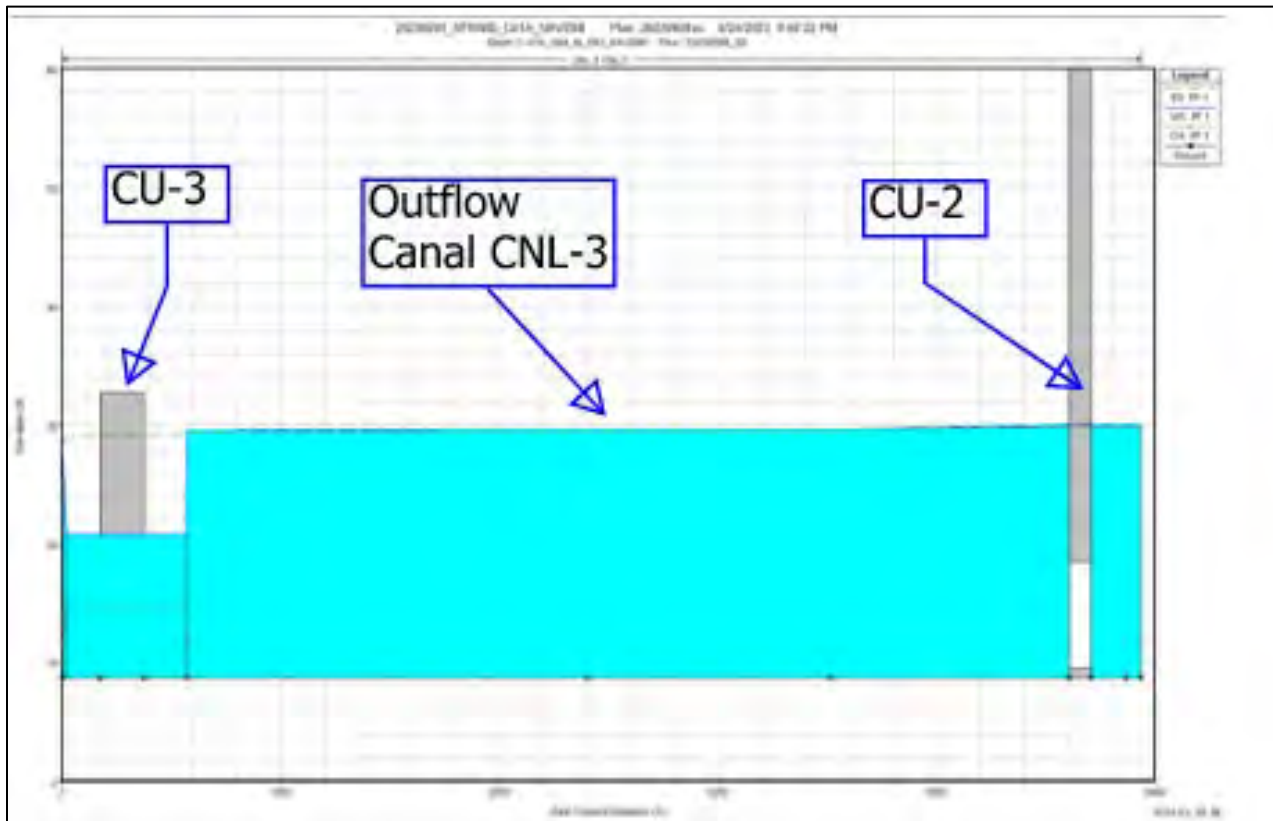


Figure A-1.1-6. CNL-3 water surface profile.

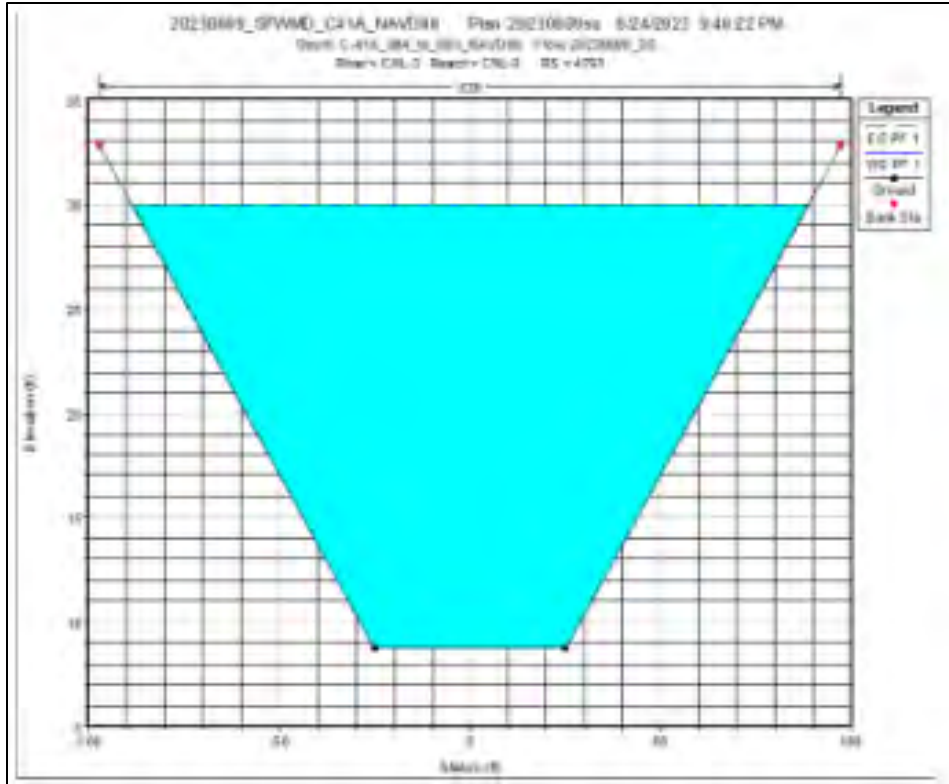


Figure A-1.1-7. CNL-3 proposed cross-section.

Table A-1.1-4. CNL-3 HECRAS results.

HEC-RAS Plan: SS3 River: CNL-3 Reach: CNL-3 Profile: PF 1											
Reach	River Sta	Q Total (cfs)	Min Ch El (ft)	W.S. Elev (ft)	Crit W.S. (ft)	E.G. Elev (ft)	E.G. Slope (ft/ft)	Vel Chnl (ft/s)	Flow Area (sq ft)	Top Width (ft)	Froude # Chl
CNL-3	4793	1500.00	8.80	30.00		30.00	0.000007	0.62	2407.86	177.18	0.03
CNL-3	4763	1500.00	8.80	30.00	11.65	30.00	0.000007	0.62	2407.78	177.18	0.03
CNL-3	4668	Infl Struct									
CNL-3	4604	1500.00	8.80	29.63		29.64	0.000008	0.64	2343.81	175.00	0.03
CNL-3	2491	1500.00	8.80	29.63		29.63	0.000008	0.64	2342.35	174.95	0.03
CNL-3	572	1500.00	8.80	29.61	11.65	29.62	0.000008	0.64	2339.93	174.87	0.03
CNL-3	265	Culvert									
CNL-3	1	1500.00	8.80	28.40	11.65	28.41	0.000010	0.70	2132.48	167.60	0.03

Table A-1.1-5. CNL-3 HECRAS results.

HEC-RAS Plan: SS3 River: CNL-3 Reach: CNL-3 Profile: PF 1										Reload Data
Reach	River Sta	E.G. Elev (ft)	W.S. Elev (ft)	Q Total (cfs)	Q Weir (cfs)	Q Gates (cfs)	Q Culv (cfs)	Q Inline RC (cfs)	Q Outlet TS (cfs)	Q Breach (cfs)
CNL-3	4668	33.33	33.33	1500.00		1500.00				0.00

Table A-1.1-6. CNL-3 HECRAS results.

HEC-RAS Plan: SS3 River: CNL-3 Reach: CNL-3 Profile: PF 1										
Reach	River Sta	E.G. Elev (ft)	W.S. Elev (ft)	Vel Head (ft)	Frctn Loss (ft)	C & E Loss (ft)	Q Left (cfs)	Q Channel (cfs)	Q Right (cfs)	Top Width (ft)
CNL-3	4793	30.00	30.00	0.01	0.00	0.00		1500.00		177.18
CNL-3	4763	30.00	30.00	0.01				1500.00		177.18
CNL-3	4668	Infl Struct								
CNL-3	4604	29.64	29.63	0.01	0.00	0.00		1500.00		175.00

2.0 Pump Station Hydraulic Calculations

A full-page version of each horsepower calculation table shown in **Sections 2.1 through 2.3**, is provided in **Annex A-1.2**.

2.1 PS-1 Pump Station

Pump Station PS-1 will back pump from the C-38 Canal into the C-41A Canal for conveyance to the reservoir pump station. To estimate power pump station facilities sizes, horsepower estimates were calculated for the PS-1 based on the range of pumping conditions. Pump dimensions and operation curves were provided by Xylem Flygt for the types of pumps (**Figure A-1.1-8** and **Figure A-1.1-9**) that would operate at PS-1. Based on the pump curves and pump head conditions, operating horsepowers were estimated. The operating condition varied from initial startup to normal operation. These conditions are the power requirements provided in **Table A-1.1-7**. These estimates were used to determine electrical equipment requirements. Head conditions were based on historic water levels in C-41A and C-38.

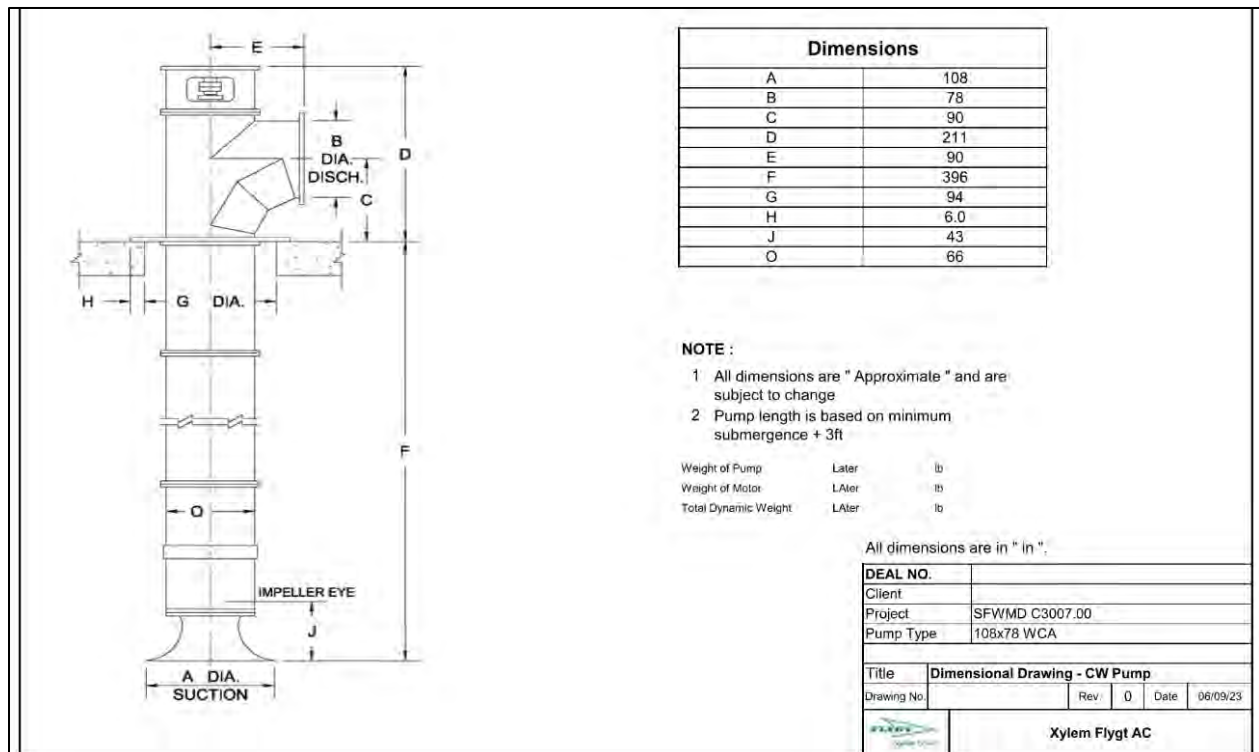


Figure A-1.1-8. PS-1 preliminary dimensions for typical 375 cfs pump (pump shown has intake bell that will be replaced with formed suction intake FSI).

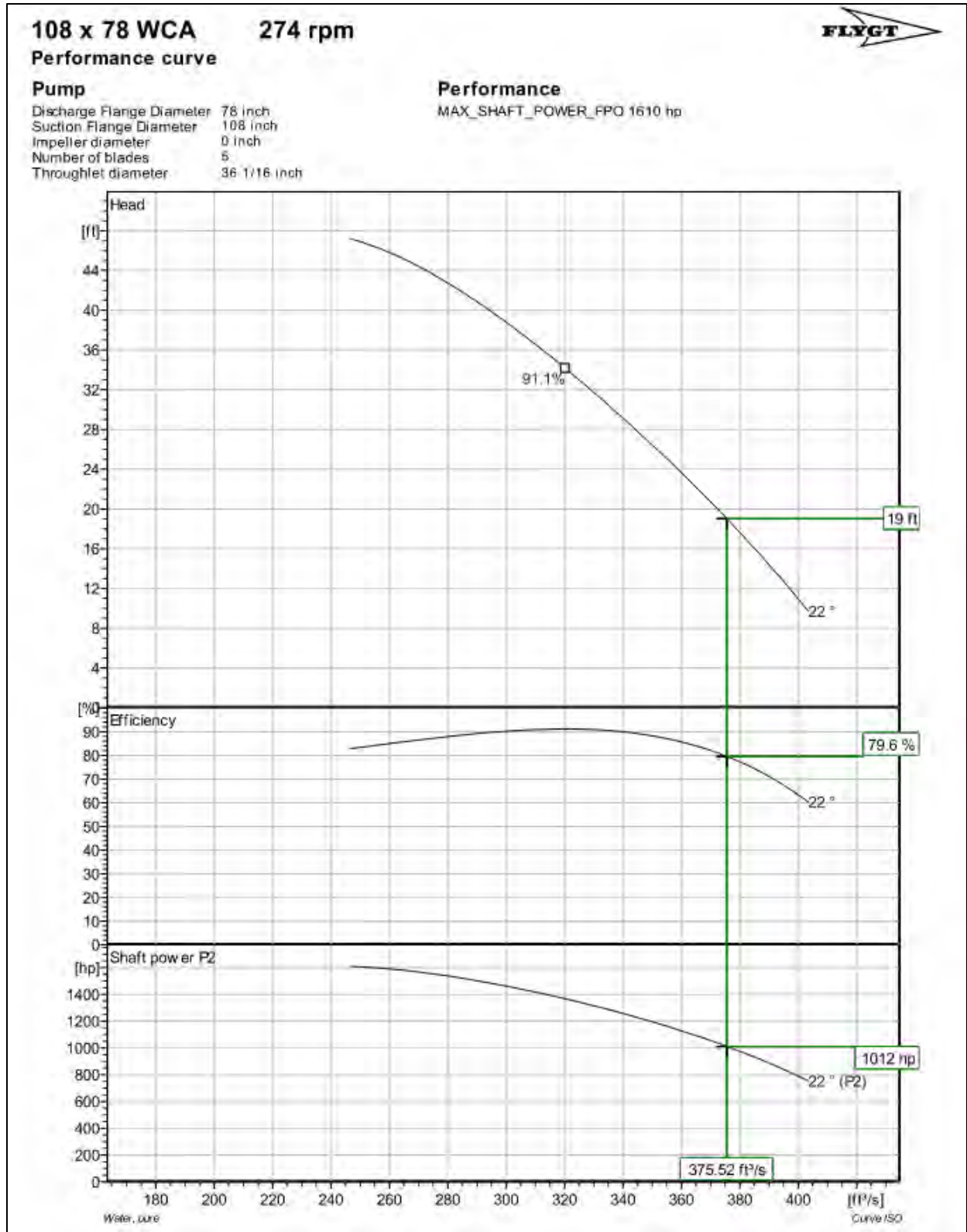


Figure A-1.1-9. PS-1 Example Performance Curve for Typical 375 cfs Pump.

Table A-1.1-7. PS-1 Pump Station horsepower calculations.

PS-1 (at S-84 Structure)												
4 - pumps 375 cfs each												
Intake	High	16.4 (ft NAVD88)	Discharge	High	24 (ft NAVD88)							
Water Level	Avg	12.8 (ft NAVD88)	Water Level	Avg	24 (ft NAVD88)							
Range	Low	9.5 (ft NAVD88)	Range	Low	24 (ft NAVD88)							
Horsepower per Pump												
Flow	Operating Water Levels					Water Horsepower	Pump eff	Motor eff	Service Factor	Horsepower		Comment
	Intake	Discharge	Losses	Head	Required					Use		
(gpm)	(ft NAVD88)	(ft NAVD88)	(ft)	(ft)	(hp)				(hp)	(hp)		
160200	13.75	30.3	7.5	24.6	994	0.87	0.9	1.15	1467		Priming	
174600	13.75	21.9	8.4	17.1	753	0.72	0.9	1.15	1337		Rated	
168300	13.75	24.2	8.0	19.0	806	0.79	0.9	1.15	1304		Design	
172000	16.4	23.1	8.2	14.9	650	0.80	0.9	1.15	1043		Min	
										1600		

Motor eff = Electric motor efficiency

Notes:
 PS-1 is designed to operate with a maximum of four 375 cfs pumps running simultaneously. Start-up of each pump will be staggered. Priming discharge stage is based on discharge pipe raised for backflow prevention, with a max. invert elev. of 26.00 (24.00 C-41A high operating stage+2' buffer) and the discharge pipe flowing 2/3 full and 0.5' loss in trash rack. See Appendix A.12.1 for additional detail on Losses calculation.

2.2 PS-2 Pump Station

Pump Station PS-2 will pump from the C-41A Canal into the LOCAR. For estimating power pump station facilities sizes horsepower estimates were calculated for the PS-2 based on the range of pumping conditions. Pump dimensions and operation curves were provided by Xylem Flygt for the pumps (**Figure A-1.1-10** and **Figure A-1.1-11**) that would operate at this station. Based on the pump curves and pump head conditions, operating horsepowers were estimated. The operating condition varied from initial startup to normal operation. These conditions are power requirements are provided in **Table A-1.1-8**. These estimates were used to determine electrical equipment requirements.

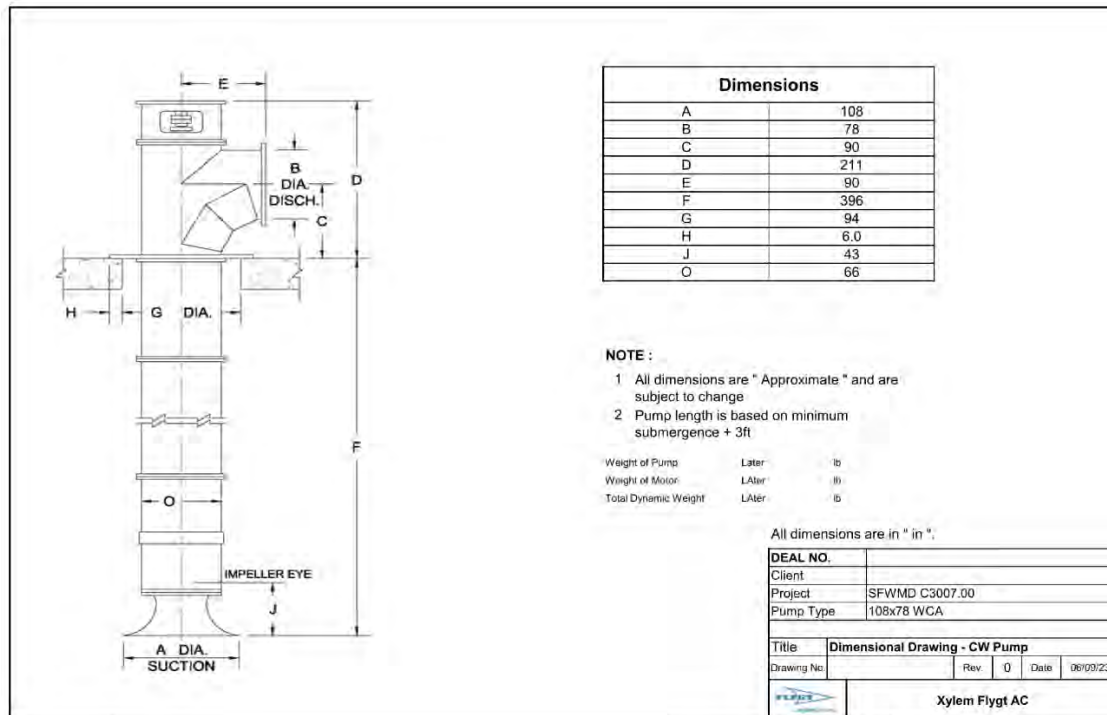


Figure A-1.1-10. PS-1 preliminary dimensions for typical 375 cfs pump (pump shown has intake bell that will be replaced with formed suction intake FSI).

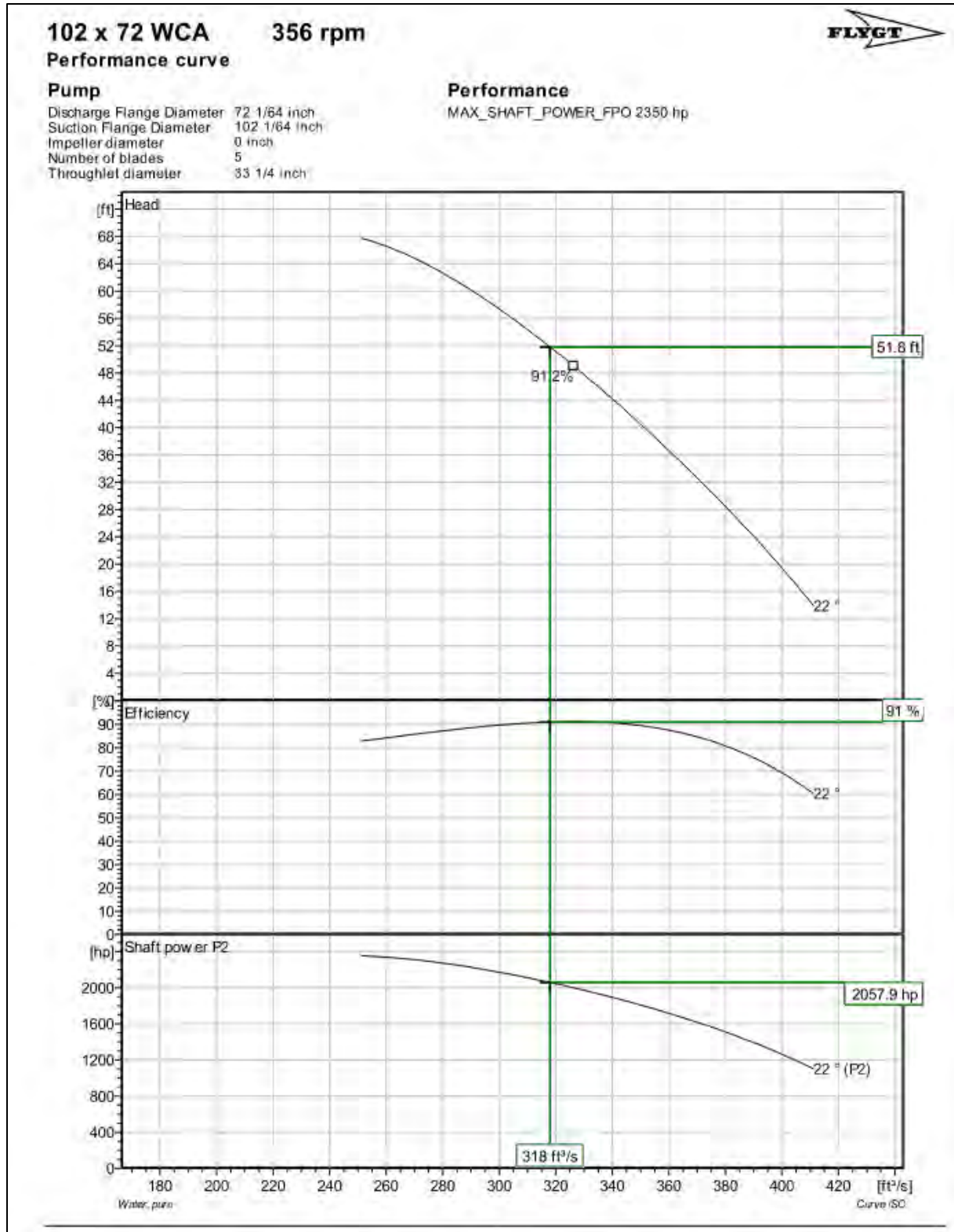


Figure A-1.1-11. PS-1 example performance curve for typical 375 cfs pump.

Table A-1.1-8. PS-2 Pump Station horsepower calculations.

PS-2 (on C-41A Canal NW SR70)												
4 - pumps 375 cfs each												
Intake	High	20 (ft NAVD88)		Discharge	High	51.7 (ft NAVD88)						
Water Level	Avg	19 (ft NAVD88)		Water Level	Avg	41.85 (ft NAVD88)						
Range	Low	18 (ft NAVD88)		Range	Low	32 (ft NAVD88)						
Horsepower per Pump												
Flow	Operating Water Levels					Water Horsepower	Pump eff	Motor eff	Service Factor	Horsepower		Comment
	Intake	Discharge	Losses	Head	Required					Use		
(gpm)	(ft NAVD88)	(ft NAVD88)	(ft)	(ft)	(hp)				(hp)	(hp)		
144000	22	63.9	9.6	52.0	1893	0.91	0.9	1.15	2658		Priming	
164000	22	51.7	10.7	40.9	1696	0.9	0.9	1.15	2408		Rated	
168300	22	41.5	12.0	32.0	1361	0.85	0.9	1.15	2045		Design	
182000	24	35	13.0	24.0	1105	0.77	0.9	1.15	1833		Min	
										2700		

Motor eff = Electric motor efficiency

Notes:
 PS-2 is designed to operate with a maximum of four 375 cfs pumps running simultaneously. Start-up of each pump will be staggered. Priming discharge stage is based on discharge pipe raised for backflow prevention, with a max. invert elev. of 59.60 (56.30 peak PMF stage + 1.3' max. wind setup + 2' buffer) and the discharge pipe flowing 2/3 full and 0.5' loss in trash rack. See Appendix A.12.1 for additional detail on Losses calculation.

2.3 SPS-1 Seepage Pump Station

Pump Station SPS-1 will pump seepage from the perimeter canal into the LOCAR. For estimating power pump station facilities sizes horsepower estimates were calculated for the SPS-1 based on the range of pumping conditions. Pump dimensions and operation curves were provided by Xylem Flygt for the pumps (**Figure A-1.1-12** and **Figure A-1.1-13**) that would operate at this station. Based on the pump curves and pump head conditions, operating horsepowers were estimated. The operating condition varied from initial startup to normal operation. These conditions are power requirements are provided in **Table A-1.1-9**. These estimates were used to determine electrical equipment requirements.

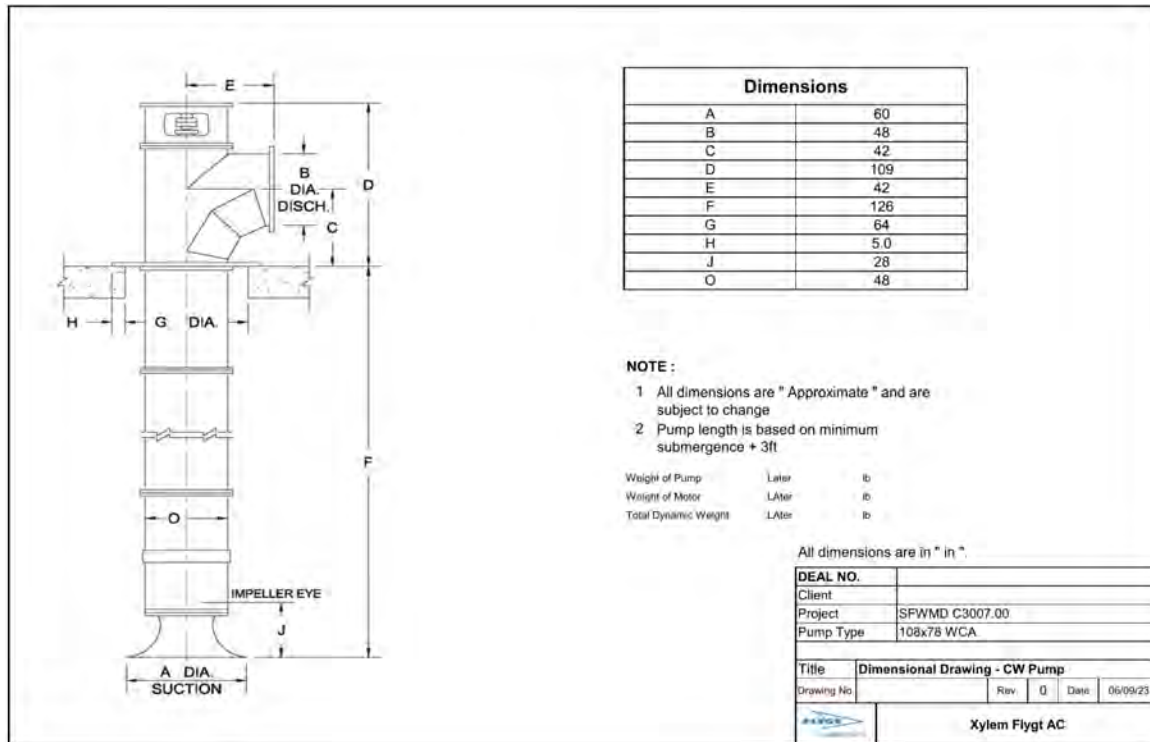


Figure A-1.1-12. PS-2 preliminary dimensions for typical 375 cfs pump (pump shown has intake bell that will be replaced with formed suction intake FSI).

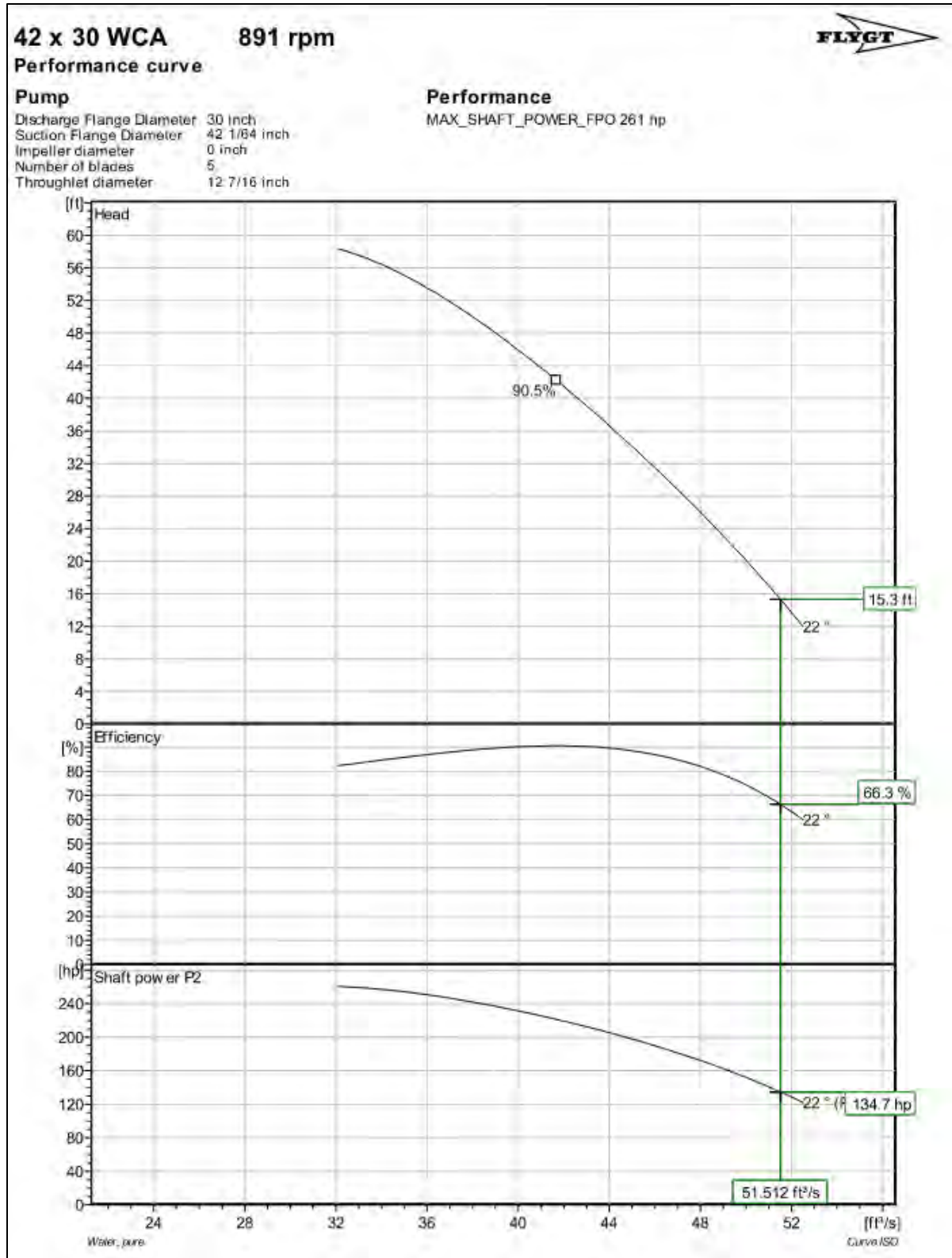


Figure A-1.1-13. PS-2 example performance curve for typical 375 cfs pump.

Table A-1.1-9. SPS-1 Pump Station horsepower calculations.

SPS-1 (on C-41A Canal NW SR70)												
2 - pumps 50 cfs each (plus an auxillary 50 cfs pump)												
Intake	High	23 (ft NAVD88)	Discharge	High	51.7 (ft NAVD88)							
Water Level	Avg	23 (ft NAVD88)	Water Level	Avg	41.85 (ft NAVD88)							
Range	Low	23 (ft NAVD88)	Range	Low	32 (ft NAVD88)							
Horsepower per Pump												
Flow		Operating Water Levels		Losses	Head	Water Horsepower	Pump eff	Motor eff	Service Factor	Required	Use	Comment
	(gpm)	(ft NAVD88)	(ft NAVD88)	(ft)	(ft)	(hp)				(hp)	(hp)	
	18000	24	61.6	5.9	44.0	200	0.90	0.9	1.15	284		Priming
	19900	24	51.7	6.6	34.8	175	0.88	0.9	1.15	254		Rated
	21500	24	53.6	7.3	25.9	141	0.83	0.9	1.15	217		Design
	22900	24	35	7.9	18.9	109	0.70	0.9	1.15	200		Min
<i>Motor eff = Electric motor efficiency</i>											300	

Notes:
 SPS-1 is designed to operate with a maximum of two 50 cfs pumps running simultaneously. Start-up of each pump will be staggered. SPS-1 will include an auxillary 50 cfs pump, to be used in the event that one or both primary pumps is not operational. Priming discharge stage based on disch. pipe raised for backflow prevention, with a max. invert elev. of 59.60 (56.30 peak PMF stage + 1.3' max. wind setup + 2' buffer) , the disch. pipe flowing 2/3 full and 0.5' loss in trash rack. See Appendix A.12.1 for additional detail on Losses calculation.

3.0 Structure Hydraulic Calculations

For the structures, a low water elevation of 33.5 ft NAVD88 was used in the reservoir to calculate flow.

3.1 CU-1A

Gated outflow culvert from East Cell to the to the Perimeter Canal. This structure will use two roller gates to control flow. Gate opening were sized based on the minimum area needed to convey the flow of 1,500 cfs with 1 ft of headloss.

A low water level of 33.5 ft NAVD88 in the reservoir was used to calculate gate size. A stage of 33.5 ft upstream and 26.2 ft downstream was used. The gated structure will have a flat bottom and gate above the water would flow as an open channel. Ground elevation 27.0 ft NAVD88 at the structure site. The equation for tranquil flow through a box culvert shown in **Figure A-1.1-14** was used to perform the preliminary design calculations for CU-1A. The results of the calculations are summarized in **Table A-1.1-10**. Two 14-ft-wide by 10-ft-tall box culverts will convey the flow with 1 ft of headloss.

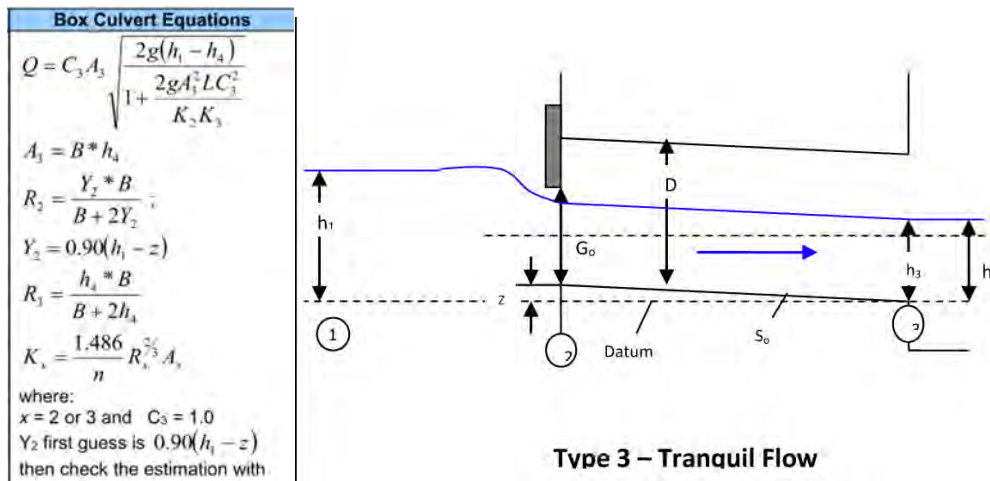


Figure A-1.1-14. Box culvert partial flow equation and diagram.

Table A-1.1-10. CU-1A Box Culvert partial flow equation calculations summary table.

	w (ft)	h (ft)							
Box	14	10							
Q (cfs)	C	A (sqft)	g	inv	upstm	h1	dwstm	h2	L
751.7	1	105	32.2	25	33.5	8.5	30.0	7.5	400

3.2 CU-2

Gated outflow culvert from the West Cell to C-41A via CNL-3. This structure will use two roller gates to control flow in CNL-3. Gate opening were sized based on the minimum area needed to convey the flow of 1,500 cfs between the West Cell and CNL-3 with 1 ft of headloss.

A Low water level of 33 ft NAVD88 in the reservoir was used to calculate gate size. A stages of 33.5 and 32.5 ft, upstream and downstream respectively was used. The gated structure will have a flat bottom and gate above the water would flow as an open channel. Ground elevation 27.0 ft NAVD88 at the structure site. The equation for tranquil flow through a box culvert shown in **Figure A-1.1-14** was used to perform the preliminary design calculations for CU-2. The results of the calculations are summarized in **Table A-1.1-11**. Two 14-ft-wide by 10-ft-tall box culverts will convey the flow with 1 ft of headloss.

Table A-1.1-11. CU-2 Box Culvert partial flow equation calculations summary table.

	w (ft)	h (ft)							
Box	14	10							
Q (cfs)	C	A (sqft)	g	inv	upstm	h1	dwstm	h2	L
751.7	1	105	32.2	25	33.5	8.5	32.5	7.5	400

3.3 CU-3

An ungated culvert will connect CNL-3 to the C-41A, west of the S-83 structure. This culvert will have an invert of 8.8 ft NAVD88 to match the bottom of the C-41A canal west of the S-83. Design flow conditions are 1,500 cfs with 1.0 of headloss. Minimum water levels in the C-41A canal are 26.4 ft NAVD88. Flow calculations are based on culvert flowing full conditions. Hydroflow Express by Autodesk was used to calculate headloss through CU-2. The results of of these calculations are shown in **Figure A-1.1.15**. Two 10-ft-wide by 12-ft-tall box culverts will convey the flow with 1 ft of headloss.

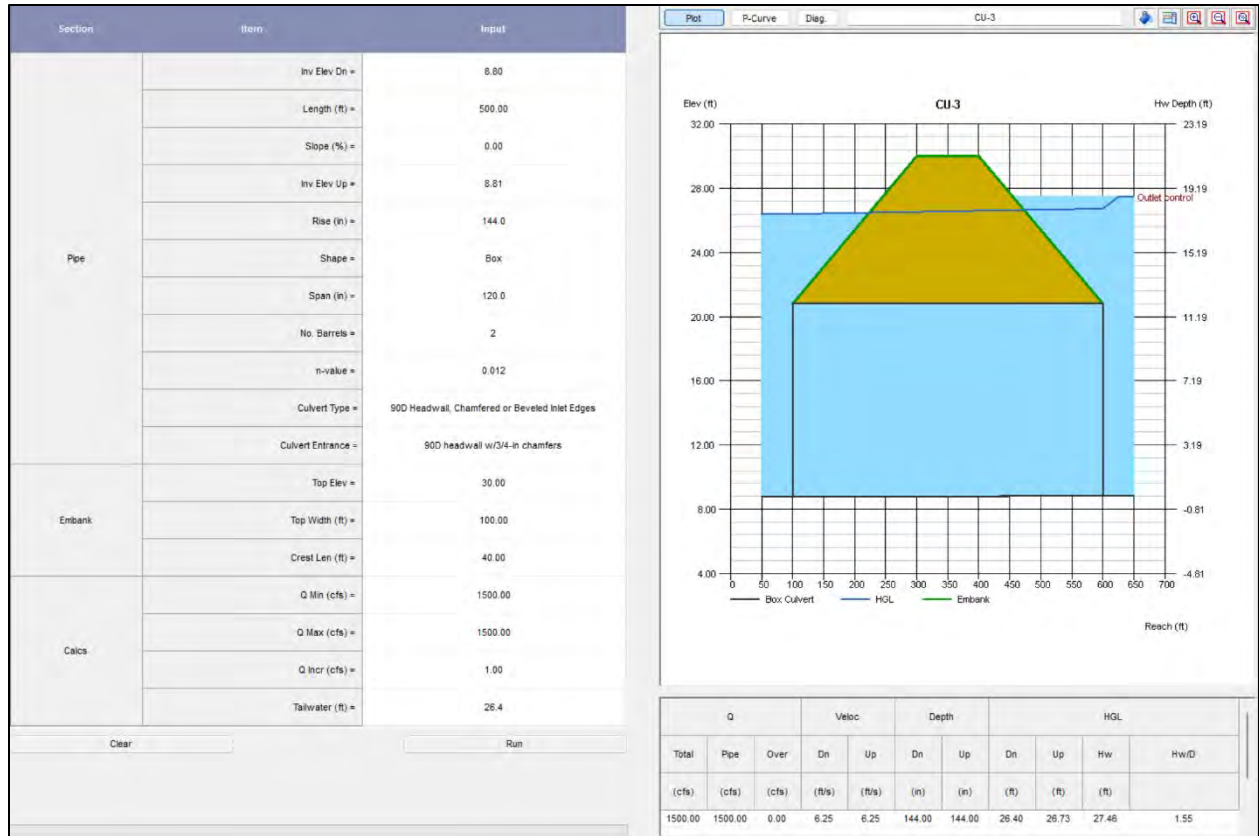


Figure A-1.1-15. CU-3 Box Culvert Full Flow Calculations Summary.

3.4 DDS-1

A dam divider structure will be used to equalize levels between the East and West Cells. This structure will use two roller gates to control flow and a concrete channel to connect the cells. Gate openings were sized based on the minimum area needed to convey the flow of 1,500 cfs between the cells with 0.5 ft of headloss.

A low water level of 33 ft NAVD88 in the reservoir was used to calculate gate size. A stage of 33.5 ft upstream and 33.0 ft downstream was used. The gated structure will have a flat bottom and gate above the water would flow as an open channel. Ground elevation of 27.0 ft NAVD88 was used at the structure site. The equation for tranquil flow through a box culvert shown in **Figure A-1.1-16** was used to perform the preliminary design calculations for DDS-1. The results of the calculations are summarized in **Table A-1.1-12**.

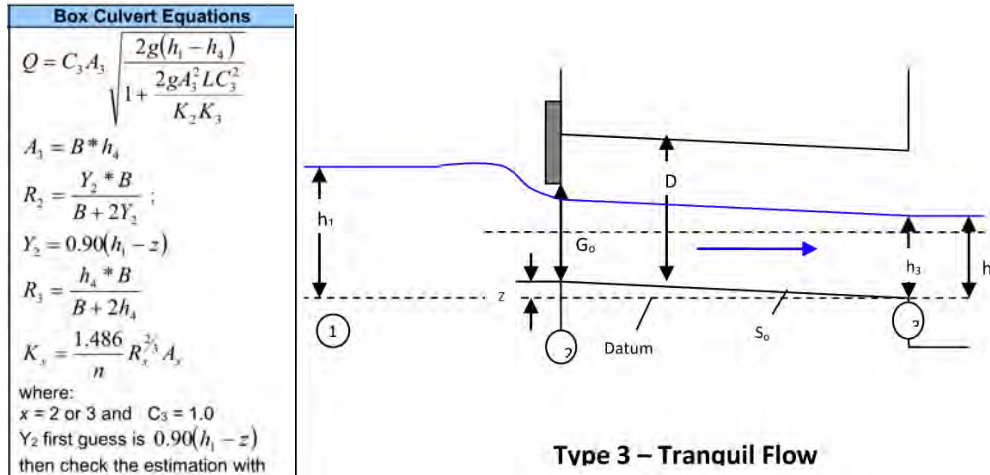


Figure A-1.1-16. Box Culvert Partial Flow Equation and Diagram.

Table A-1.1-12. DDS-1 Box Culvert partial flow equation calculations summary table.

	w (ft)	h (ft)							
Box	22	10							
Q (cfs)	C	A (ft ²)	g	Inv (ft NAVD88)	Upstm (ft NAVD88)	h1(ft)	Dwstm (ft NAVD88)	h2 (ft)	L (ft)
791.3	1	154	32.2	26	33.5	7.5	33	7	400

Two 22-ft-wide gates with a bottom elevation of 26.0 ft NAVD88.

3.5 PCW-1 through PCW-7, PCOS-1 through PCOS-4, and ODCD-OS-1

PCW-1 through PCW-10 are adjustable weir structures to be used to control the water levels within Reaches 1A through 7 of the Reservoir Perimeter Canal (CNL-1) to minimize seepage impacts outside of the reservoir as well as keep seepage exit gradients from the reservoir into the perimeter canal within allowable limits to ensure stability of the Reservoir Perimeter Dam. The weir crest width of each of these structures will be finalized during the PED phase with the updated seepage rates from the various locations around the reservoir, together with updated results of stormwater routing through CNL-1. Planning level modeling of these conditions is documented in **Annex A-2.6**.

3.6 PCOS-1 through PCOS-4, and ODCD-OS-1

PCOS-1 through PCOS-4 and ODCD-OS-1 are fixed weir structures with one or more outfall culverts, located within Reach 7 of the perimeter canal or in the case of ODCS-1 located within ODCD-1, that will function as gravity overflow structures for Reach 7 and ODCD-1. The preliminary crest elevation for each of these structures has been set to 25.5 ft NAVD88, which is 18 inches above the wet and dry season control elevation of Reach 7 (24.0 ft NAVD88). The weir crest width of each of these structures will be finalized during the PED phase with the updated seepage rates from the various locations around the reservoir, together with updated results of stormwater routing through CNL-1. Planning level modeling of these conditions is documented in **Annex A-2.6**.

3.7 S-84+ Spillway

The S-84+ spillway will replace existing spillways S-84 and S-84X. An ogee weir configuration will be used with a crest elevation of 13.5 ft NAVD88 for S-84+. The Three-22-ft-wide gates proposed for S-84+ will each provide a flow capacity of 3,010 cfs based on uncontrolled free discharge and an ogee weir coefficient of 3.7, per the ogee weir flow equation shown in **Figure A-1.1-17**. The results of the calculations are summarized in **Table A-1.1-13**.

$$Q = C_d L \sqrt{H^3}$$

Criteria: $\frac{H}{G_o} < 1.0$ and $\frac{h}{H} < 0.5$

Figure A-1.1-17. Ogee Weir Flow Equation.

Table A-1.1-13. S-84+ Ogee Weir flow equation calculations summary table.

Q (cfs)	Cd	L (ft)	HW	Crest	H
3010	3.7	22	24.6	13.5	11.1

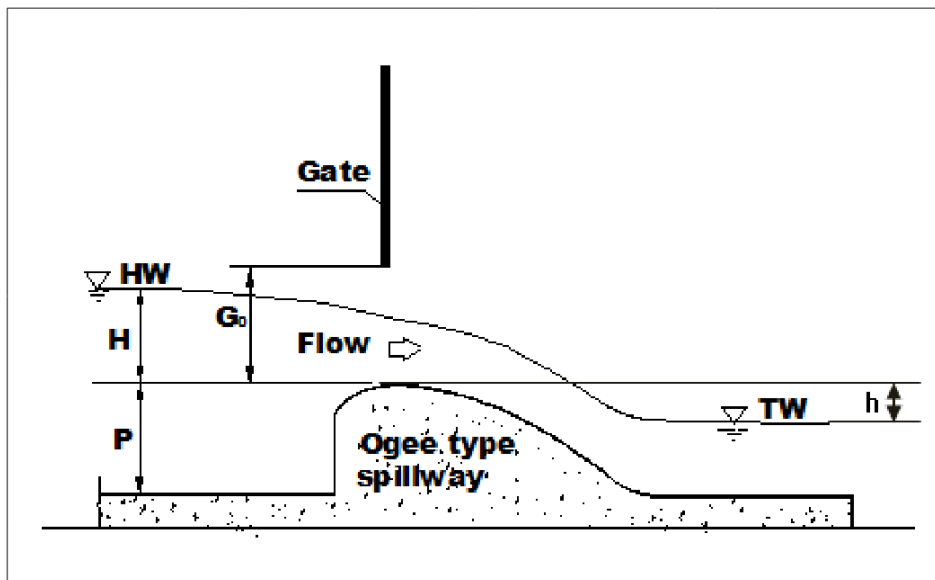


Figure A-1.1-18. Ogee Weir Flow Diagram.

SFWMD LOCAR
Pump HP Estimates

Pump Power Requirements

PS-1 (at S-84 Structure)

4 - pumps 375 cfs each											
Intake	High	16.4 (ft NAVD88)	Discharge	High	24 (ft NAVD88)						
Water Level	Avg	12.8 (ft NAVD88)	Water Level	Avg	24 (ft NAVD88)						
Range	Low	9.5 (ft NAVD88)	Range	Low	24 (ft NAVD88)						
Horsepower per Pump											
Operating Water Levels									Horsepower		
Flow	Intake	Discharge	Losses	Head	Water Horsepower	Pump eff	Motor eff	Service Factor	Required	Use	Comment
(gpm)	(ft NAVD88)	(ft NAVD88)	(ft)	(ft)	(hp)				(hp)	(hp)	
160200	13.75	30.3	7.5	24.6	994	0.87	0.9	1.15	1467		Priming
174600	13.75	21.9	8.4	17.1	753	0.72	0.9	1.15	1337		Rated
168300	13.75	24.2	8.0	19.0	806	0.79	0.9	1.15	1304		Design
172000	16.4	23.1	8.2	14.9	650	0.80	0.9	1.15	1043		Min

Motor eff = Electric motor efficiency

1600

Notes:

PS-1 is designed to operate with a maximum of four 375 cfs pumps running simultaneously. Start-up of each pump will be staggered. Priming discharge stage is based on discharge pipe raised for backflow prevention, with a max. invert elev. of 26.00 (24.00 C-41A high operating stage+2' buffer) and the discharge pipe flowing 2/3 full and 0.5' loss in trash rack. See Appendix A.12.1 for additional detail on Losses calculation.

SFWMD LOCAR
Pump HP Estimates

PS-2 (on C-41A Canal NW SR70)

4 - pumps 375 cfs each											
Intake	High	20 (ft NAVD88)	Discharge	High	51.7 (ft NAVD88)						
Water Level	Avg	19 (ft NAVD88)	Water Level	Avg	41.85 (ft NAVD88)						
Range	Low	18 (ft NAVD88)	Range	Low	32 (ft NAVD88)						
Horsepower per Pump											
		Operating Water Levels							Horsepower		
Flow	Intake	Discharge	Losses	Head	Water Horsepower	Pump eff	Motor eff	Service Factor	Required	Use	Comment
(gpm)	(ft NAVD88)	(ft NAVD88)	(ft)	(ft)	(hp)				(hp)	(hp)	
144000	22	63.9	9.6	52.0	1893	0.91	0.9	1.15	2658		Priming
164000	22	51.7	10.7	40.9	1696	0.9	0.9	1.15	2408		Rated
168300	22	41.5	12.0	32.0	1361	0.85	0.9	1.15	2045		Design
182000	24	35	13.0	24.0	1105	0.77	0.9	1.15	1833		Min
<i>Motor eff = Electric motor efficiency</i>										2700	

Notes:
 PS-2 is designed to operate with a maximum of four 375 cfs pumps running simultaneously. Start-up of each pump will be staggered. Priming discharge stage is based on discharge pipe raised for backflow prevention, with a max. invert elev. of 59.60 (56.30 peak PMF stage + 1.3' max. wind setup + 2' buffer) and the discharge pipe flowing 2/3 full and 0.5' loss in trash rack. See Appendix A.12.1 for additional detail on Losses calculation.

SFWMD LOCAR
Pump HP Estimates

SPS-1 (on C-41A Canal NW SR70)

2 - pumps 50 cfs each (plus an auxillary 50 cfs pump)											
Intake	High	23 (ft NAVD88)			Discharge	High	51.7 (ft NAVD88)				
Water Level	Avg	23 (ft NAVD88)			Water Level	Avg	41.85 (ft NAVD88)				
Range	Low	23 (ft NAVD88)			Range	Low	32 (ft NAVD88)				
Horsepower per Pump											
		Operating Water Levels							Horsepower		
Flow	Intake	Discharge	Losses	Head	Water Horsepower	Pump eff	Motor eff	Service Factor	Required	Use	Comment
(gpm)	(ft NAVD88)	(ft NAVD88)	(ft)	(ft)	(hp)				(hp)	(hp)	
18000	24	61.6	5.9	44.0	200	0.90	0.9	1.15	284		Priming
19900	24	51.7	6.6	34.8	175	0.88	0.9	1.15	254		Rated
21500	24	53.6	7.3	25.9	141	0.83	0.9	1.15	217		Design
22900	24	35	7.9	18.9	109	0.70	0.9	1.15	200		Min
<i>Motor eff = Electric motor efficiency</i>										300	

Notes:

SPS-1 is designed to operate with a maximum of two 50 cfs pumps running simultaneously. Start-up of each pump will be staggered. SPS-1 will include an auxiliary 50 cfs pump, to be used in the event that one or both primary pumps is not operational. Priming discharge stage based on disch. pipe raised for backflow prevention, with a max. invert elev. of 59.60 (56.30 peak PMF stage + 1.3' max. wind setup + 2' buffer) , the disch. pipe flowing 2/3 full and 0.5' loss in trash rack. See Appendix A.12.1 for additional detail on Losses calculation.

ANNEX A-2
Hydrologic Modeling

- A-2.1 PMP Determination and PMF Routing Technical Memorandum
- A-2.2 STWAVE Overtopping Analysis Technical Memorandum
- A-2.3 Computational Fluid Dynamics Overtopping Analysis Technical Memorandum
- A-2.4 SFWMD Regional Simulation Model Documentation Report
- A-2.5 Assessment of Allowable Wave Overtopping Technical Memorandum
- A-2.6 Reservoir Perimeter Canal System Modeling Technical Memorandum
- A-2.7 Dam Breach Modeling Technical Memorandum



Lake Okeechobee Compartment A Storage Reservoir PMP Determination and PMF Routing



Prepared for:	South Florida Water Management District
Prepared by:	Collective Water Resources on behalf of J-Tech, an Alliance between Jacobs Engineering and Tetra Tech, Inc.
Date:	November 15, 2023
Subject:	Lake Okeechobee Component A Storage Reservoir Feasibility Study - PMP Determination and PMF Routing

1.0 Background/Introduction

This document summarizes the methods and outcome for both the Probable Maximum Precipitation (PMP) and the Probable Maximum Flood (PMF) routing for the Lake Okeechobee Component A Storage Reservoir (LOCAR or Reservoir). The PMP was determined for the Reservoir site to support the development of the PMF routing model. The PMF routing model was developed to determine the reservoir emergency spillway sizes under design criteria specifications, as well as to support the wind and wave runup analyses that were performed to determine the required dam embankment height of the Reservoir.

The proposed LOCAR site is in the C-41A Basin, just north of the C-41A Canal and east of the S-83 gated spillway and northwest of the S-84 gated spillway. Surrounding lands consist mostly of mixed agricultural uses. Major roads near the project site include State Road 70 to the south and County Road 721 to the east.

For the PMP development, three reservoir alternatives were considered as shown in Figure 1. HEC-MetVue was utilized to develop the PMP for each of the alternatives as described in Section 2.

For the PMF routing, only the LOCAR Recommended Plan; which is based on the Alternative 1 reservoir footprint, modified to avoid an environmentally sensitive area along the south side of the reservoir was evaluated. Time series datasets were created using the developed PMP and the scenarios outlined in the South Florida Water Management District (SFWMD) and US Army Corps of Engineers (USACE) Design Criteria Memorandum 2, dated February 6, 2006 (DCM-2). A HEC-RAS model was developed using the Alternative 1 specifications provided by the J-Tech project team to size the ungated spillways in each cell. Peak allowable discharge was managed to ensure that total outflow from the reservoir did not exceed the capacity of the C-41A canal. The PMF Routing is described in Section 3.

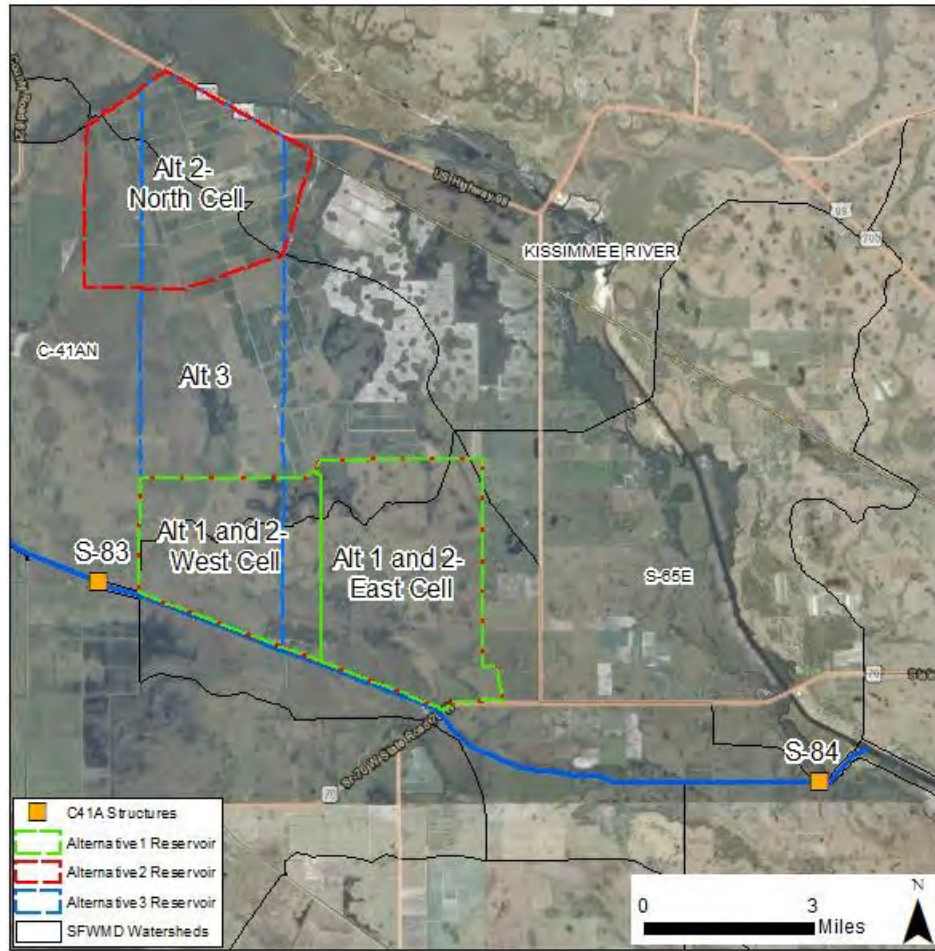


Figure 1. LOCAR Location and Alternatives

2.0 Probable Maximum Precipitation Development

The National Oceanic and Atmospheric Administration (NOAA) Hydrometeorological Report (HMR) No. 55A (1988) defines the PMP as “theoretically, the greatest depth of precipitation for a given duration that is physically possible over a given area at a particular geographic location at a certain time of year.” As part of this task, multiple scenarios were run for the three reservoir alternatives, to determine the maximum PMP depth for each reservoir alternative.

2.1 PMP Model Development

HEC-MetVue, including the integrated HMR52 plugin, was utilized for development of the PMP. HEC-MetVue is a precipitation viewing and analysis tool developed by the USACE. The HMR52 plugin automates the process outlined in the NOAA HMR52 (1982) Storm Precipitation Method by using the user-input storm area, location, storm orientation, and temporal pattern combined with the integrated Depth-Area-Duration values from NOAA HMR 51 (1978) to compute a subbasin average PMP hyetograph.

2.1.1 Model Inputs

User inputs included basin extents and location, storm area, temporal pattern, and storm orientation. Storm location was determined by the centroid of the proposed reservoir boundary uploaded as a shapefile to the HEC-MetVue interface. Storm orientation was run both as the preferred storm orientation for Florida (195 degrees) per HMR52 Figure 10, as well as the default storm orientation that aligned best with the reservoir orientation to optimize overlap. Storm size was selected for the storm that produced the largest PMP. A summary of user defined inputs is presented in Table 1 for each reservoir alternative.

Table 1. HEC-MetVue Model Inputs for Reservoir Alternatives 1, 2 and 3.

Model Run	Reservoir Alternative	Storm Orientation (degrees)		Storm Area (sq. mi)	Centroid Coordinates (Latitude Longitude)	
		Preferred	Basin Aligned		Latitude	Longitude
1	1	Preferred	195	175	27.27	-81.11
2		Basin Aligned	94			
3	2	Preferred	195	300	27.31	-81.13
4		Basin Aligned	146			
5	3	Preferred	195	175	27.32	-81.15
6		Basin Aligned	169			

2.2 PMP Results

The model was simulated for each of the model runs identified in Table 1, which resulted in the PMP depths summarized in Table 2. The LOCAR Alternative 1 results were selected to use for the PMF routing because the Alternative 1 reservoir footprint aligns with the LOCAR Recommended Plan reservoir footprint. The Alternative 1 basin aligned storm orientation was selected for use in the PMF routing due to the greater PMP depth produced. The rainfall time series for the selected PMP is presented in Table 3.

Table 2. Simulated PMP Depths

Model Run	Alternative	Storm Orientation	PMP Depth (inches)
1	1	Preferred	52.79
2		Basin Aligned	53.94
3	2	Preferred	50.46
4		Basin Aligned	51.76
5	3	Preferred	53.47
6		Basin Aligned	53.72



**Lake Okeechobee Compartment A Storage Reservoir
PMP Determination and PMF Routing**



Table 3. 15-Minute Time Series for Alternative 1 with Basin Aligned Storm Orientation

Hours	Inches	Hours	Inches	Hours	Inches	Hours	Inches
0.25	0.04	9.75	0.04	19.25	0.05	28.75	0.14
0.50	0.04	10.00	0.04	19.50	0.05	29.00	0.14
0.75	0.04	10.25	0.04	19.75	0.05	29.25	0.15
1.00	0.04	10.50	0.04	20.00	0.05	29.50	0.15
1.25	0.04	10.75	0.04	20.25	0.05	29.75	0.15
1.50	0.04	11.00	0.04	20.50	0.05	30.00	0.15
1.75	0.04	11.25	0.04	20.75	0.05	30.25	0.25
2.00	0.04	11.50	0.04	21.00	0.05	30.50	0.25
2.25	0.04	11.75	0.04	21.25	0.05	30.75	0.25
2.50	0.04	12.00	0.04	21.50	0.05	31.00	0.25
2.75	0.04	12.25	0.05	21.75	0.05	31.25	0.26
3.00	0.04	12.50	0.05	22.00	0.05	31.50	0.26
3.25	0.04	12.75	0.05	22.25	0.05	31.75	0.26
3.50	0.04	13.00	0.05	22.50	0.05	32.00	0.26
3.75	0.04	13.25	0.05	22.75	0.05	32.25	0.26
4.00	0.04	13.50	0.05	23.00	0.05	32.50	0.26
4.25	0.04	13.75	0.05	23.25	0.05	32.75	0.26
4.50	0.04	14.00	0.05	23.50	0.05	33.00	0.26
4.75	0.04	14.25	0.05	23.75	0.05	33.25	0.29
5.00	0.04	14.50	0.05	24.00	0.05	33.50	0.29
5.25	0.04	14.75	0.05	24.25	0.10	33.75	0.29
5.50	0.04	15.00	0.05	24.50	0.10	34.00	0.29
5.75	0.04	15.25	0.05	24.75	0.10	34.25	0.34
6.00	0.04	15.50	0.05	25.00	0.10	34.50	0.34
6.25	0.04	15.75	0.05	25.25	0.11	34.75	0.34
6.50	0.04	16.00	0.05	25.50	0.11	35.00	0.34
6.75	0.04	16.25	0.05	25.75	0.11	35.25	0.41
7.00	0.04	16.50	0.05	26.00	0.11	35.50	0.41
7.25	0.04	16.75	0.05	26.25	0.12	35.75	0.41
7.50	0.04	17.00	0.05	26.50	0.12	36.00	0.41
7.75	0.04	17.25	0.05	26.75	0.12	36.25	0.52
8.00	0.04	17.50	0.05	27.00	0.12	36.50	0.52
8.25	0.04	17.75	0.05	27.25	0.13	36.75	0.52
8.50	0.04	18.00	0.05	27.50	0.13	37.00	0.52
8.75	0.04	18.25	0.05	27.75	0.13	37.25	0.85
9.00	0.04	18.50	0.05	28.00	0.13	37.50	0.85
9.25	0.04	18.75	0.05	28.25	0.14	37.75	0.85
9.50	0.04	19.00	0.05	28.50	0.14	38.00	0.85



**Lake Okeechobee Compartment A Storage Reservoir
PMP Determination and PMF Routing**



Hours	Inches	Hours	Inches	Hours	Inches	Hours	Inches
38.25	1.23	47.75	0.18	57.25	0.05	66.75	0.04
38.50	1.23	48.00	0.18	57.50	0.05	67.00	0.04
38.75	1.23	48.25	0.07	57.75	0.05	67.25	0.04
39.00	1.23	48.50	0.07	58.00	0.05	67.50	0.04
39.25	2.95	48.75	0.07	58.25	0.05	67.75	0.04
39.50	2.95	49.00	0.07	58.50	0.05	68.00	0.04
39.75	2.95	49.25	0.07	58.75	0.05	68.25	0.04
40.00	2.95	49.50	0.07	59.00	0.05	68.50	0.04
40.25	1.03	49.75	0.07	59.25	0.05	68.75	0.04
40.50	1.03	50.00	0.07	59.50	0.05	69.00	0.04
40.75	1.03	50.25	0.07	59.75	0.05	69.25	0.04
41.00	1.03	50.50	0.07	60.00	0.05	69.50	0.04
41.25	0.68	50.75	0.07	60.25	0.05	69.75	0.04
41.50	0.68	51.00	0.07	60.50	0.05	70.00	0.04
41.75	0.68	51.25	0.07	60.75	0.05	70.25	0.04
42.00	0.68	51.50	0.07	61.00	0.05	70.50	0.04
42.25	0.25	51.75	0.07	61.25	0.05	70.75	0.04
42.50	0.25	52.00	0.07	61.50	0.05	71.00	0.04
42.75	0.25	52.25	0.07	61.75	0.05	71.25	0.04
43.00	0.25	52.50	0.07	62.00	0.05	71.50	0.04
43.25	0.25	52.75	0.07	62.25	0.05	71.75	0.04
43.50	0.25	53.00	0.07	62.50	0.05	72.00	0.04
43.75	0.25	53.25	0.07	62.75	0.05	Total	53.94
44.00	0.25	53.50	0.07	63.00	0.05		
44.25	0.24	53.75	0.07	63.25	0.05		
44.50	0.24	54.00	0.07	63.50	0.05		
44.75	0.24	54.25	0.05	63.75	0.05		
45.00	0.24	54.50	0.05	64.00	0.05		
45.25	0.23	54.75	0.05	64.25	0.05		
45.50	0.23	55.00	0.05	64.50	0.05		
45.75	0.23	55.25	0.05	64.75	0.05		
46.00	0.23	55.50	0.05	65.00	0.05		
46.25	0.20	55.75	0.05	65.25	0.05		
46.50	0.20	56.00	0.05	65.50	0.05		
46.75	0.20	56.25	0.05	65.75	0.05		
47.00	0.20	56.50	0.05	66.00	0.05		
47.25	0.18	56.75	0.05	66.25	0.04		
47.50	0.18	57.00	0.05	66.50	0.04		

3.0 Probable Maximum Flood Routing

The PMF is defined by USACE in Engineer Manual (EM) 1110-21417 (1994) as “the flood that may be expected from the most severe combination of critical meteorologic and hydrologic conditions that are reasonably possible in the region.” The PMP developed, in combination with routing scenarios outlined in the DCM-2, provided the conditions to be routed through the proposed reservoir. The PMF routing was conducted for the LOCAR Recommended Plan. The PMP rainfall depths used in the PMF routing are the result of the PMP development for Alternative 1 with a storm orientation aligned with the basin, as it produced the largest PMP depth of 53.94 inches.

3.1 Routing Criteria

3.1.1 Allowable Discharge

The total reservoir allowable peak discharge into the C-41A canal from the Reservoir was determined to be 1,500 cfs. This allowable discharge was calculated by J-Tech in order to assure no downstream impacts or adverse impacts to the C-41A channel and inline infrastructure.

3.1.2 Routing Scenarios

DCM-2 presents the design criteria for determining freeboard for reservoirs and impoundments. The scenarios evaluated in this memorandum are Case 1, Scenarios 1 and 2, as summarized below.

DCM-2 PMP Scenario 1:

Routing starts when the reservoir stage is at Normal Full Storage Level (NFSL)

- Route 30 percent of the 72-hour PMF (16.18 inches) (0 to 72-hr), gated structures are closed.
- A 3-day dry (72 to 144-hr), gated structures are operable. Assumed gated structures and ungated spillways can discharge at a combined rate up to 1,500 cfs during this time.
- Route 100 percent of the 72-hour PMF (53.94 inches) (144 to 216-hr), gated structures are closed.
- A 10-day dry interval (216 to 456-hr), gated structures are operable. Assumed gated structures and ungated spillways can discharge at a combined rate up to 1,500 cfs during this time.
- Route 30 percent of the 72-hour PMF (16.18 inches) (456 to 528-hr), gated structures are closed.

DCM-2 PMP Scenario 2:

Routing starts when the reservoir stage is at Normal Full Storage Level (NFSL)

- Route 40 percent of the 72-hour PMF (21.58 inches) (0 to 72-hr), gated structures are closed.
- A 5-day dry interval (72 to 192-hr), gated structures are operable. Assumed gated structures and ungated spillways can discharge at a combined rate up to 1,500 cfs during this time.
- Route 100 percent of the 72-hour PMF (53.94 inches) (192 to 264-hr), gated structures are closed.
- A 10-day dry interval (264 to 504-hr), gated structures are operable. Assumed gated structures and ungated spillways can discharge at a combined rate up to 1,500 cfs during this time.
- Route 40 percent of the 72-hour PMF (21.58 inches) (504 to 576-hr), gated structures are closed.

3.2 Model Setup

The PMP rainfall analysis results were applied to a HEC-RAS model (Version 6.3.1) with the LOCAR Recommended Plan configuration. The HEC-RAS model for the LOCAR Recommended Plan contains two cells, a 10.2 square mile (6,453 acres) East Cell and a 7.4 square mile (4,701 acre) West Cell (at NFSL). Each cell has a gated outflow culvert and an ungated overflow spillway. A gated culvert (DDS-1) connects the east and west cells. A portion of the C-41A canal is also represented in the model to serve as a downstream boundary condition for the reservoir outflow structures. S-83 is a SFWMD gated spillway in the C-41A canal, represented as an inoperable weir in the model. Figure 2 shows the configuration of the LOCAR Recommended Plan HEC-RAS PMF routing model.

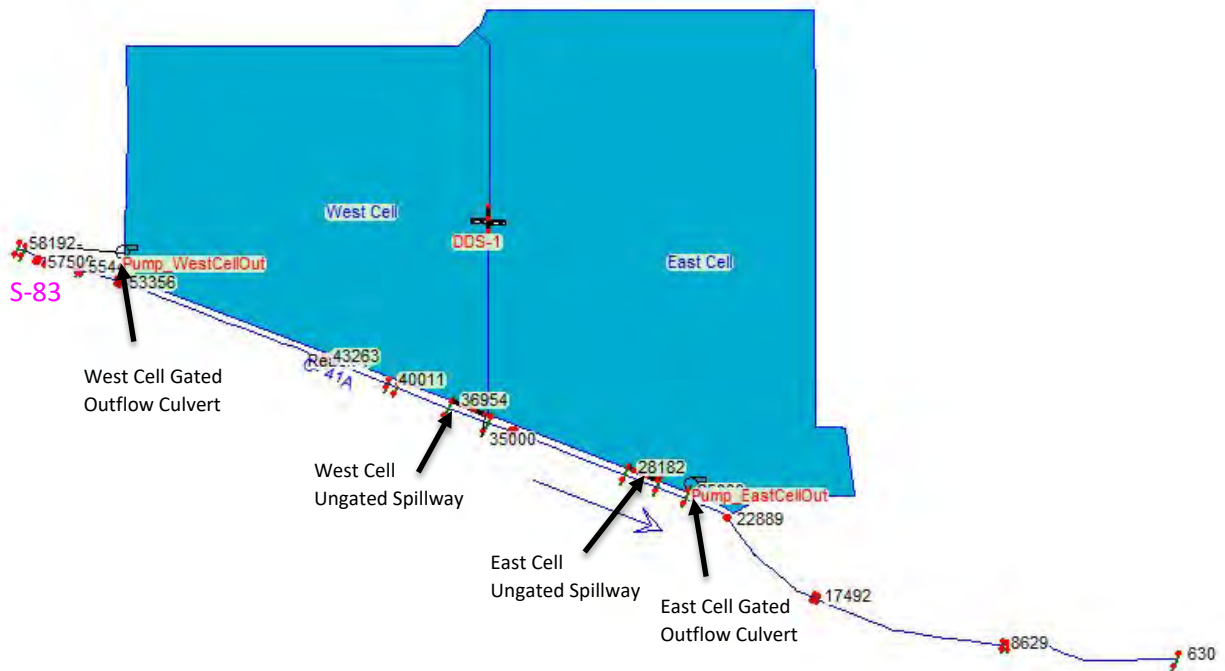


Figure 2. LOCAR Recommended Plan HEC-RAS Configuration.

*The model schematic is not representative of the reservoir footprint, for schematic purposes only.

3.2.1 Boundary Conditions

The purpose of the C-41A canal in the HEC-RAS model is to serve as a downstream boundary condition receiving the reservoir outflows. DBHYDRO stage levels were reviewed at the headwater and tailwater stations of SFWMD structures S-83 and S-84. The measurements available from the past 10 years were evaluated and the high stages measured from Hurricane Irma in September 2017 were used as the stage boundaries. The constant stage values at the upstream and downstream ends of the C-41A canal are presented in Table 5.

Table 4. LOCAR Recommended Plan: HEC-RAS Boundary Conditions

Boundary Condition Location	Stage (ft -NAVD)	Source
C-41A upstream of S-83, 960 feet upstream	31.78	DBHYDRO: Maximum Stage in September 2017 for S-83 Headwater (DBKey IY959)
C-41A downstream of S-83, 11 miles downstream	26.58	DBHYDRO: Average of maximum stages in September 2017 for S-83 Tailwater (DBKey IY961) and S-84 Headwater (DBKey IY964).

3.2.2 PMP Time Series

Two time series data sets in 15-minute time intervals were created for Scenarios 1 and 2 as described above. The PMP time series output (in inches) was converted to cubic feet per second by multiplying by the corresponding reservoir cell area at normal full storage level (NFSL). The converted time series was then manipulated per the DCM-2 scenarios described above resulting in a 22-day time series for Scenario 1 and a 24-day time series for Scenario 2. These time series were used as the inflow hydrographs for the reservoir cells. The model, with no additional inflow, was run 24 hours past the duration of each rainfall scenario, for a total of 23 days (Scenario 1) and 25 days (Scenario 2), so that the peak stages could be observed.

3.2.3 Model Input and Data Sources

The following sections describe the model input and data sources for the LOCAR Recommended Plan project features.

3.2.3.1 C-41A Canal

A HEC-RAS model of the C-41A canal was developed by the J-Tech Team and the PMF HEC-RAS model incorporated the pertinent portion of the C-41A canal from that model. The cross sections were developed by the J-tech Team based on the USACE Canal-41A, Section 2 Plan dated July 1960. Manning’s n values of 0.04 and 0.03 were used for the banks and channel, respectively.

3.2.3.2 Stage-Area & NFSL of the Reservoir Cells

The stage-area relationships for the east and west cells of LOCAR Recommended Plan reservoir were provided by J-Tech and incorporated into the storage features of the HEC-RAS model. At Normal Full Storage Level (NFSL), based on the stage-area relationships, the East cell provides a cumulative storage volume of 114,791 acre-ft (excluding storage provided within the east cell borrow area) and the West cell provides a cumulative storage volume of 84,716 acre-ft (excluding storage provided within the east cell borrow area). The initial stage of each cell is the NFSL of 51.7 ft-NAVD.

3.2.3.3 Cell Connection Structure, DDS-1

Specifications for the cell connecting structure, DDS-1, were provided by J-Tech. The structure is gated but was assumed to be open for the entirety of all simulations. The structure was modeled as a box culvert with two barrels, each 17 feet wide by 12 feet tall, as per the conceptual design plans. Inverts were set at 23.0 feet-NAVD based on the bottom of the reservoir cells.



Lake Okeechobee Compartment A Storage Reservoir PMP Determination and PMF Routing



3.2.3.4 Gated Outflow Culverts

Both the east and west cells are designed with a gated outflow culvert, with a design maximum discharge of 1,500 cfs per structure. The west cell gated culvert discharges in the C-41A canal upstream of S-83, while the east cell gated culvert discharges downstream of S-83. Per the DCM-2 routing scenarios, the gates are required to remain closed during the time steps when the PMP events are occurring; however, they may open during the dry periods. As discussed in Section 3.1.1, the total discharge from the reservoir, which accounts for outflow from all gated culverts and the spillways collectively, must remain below the calculated allowable discharge (1,500 cfs). The East and West uncontrolled spillway outflows were given priority so that when the gated culvert was permitted to operate in the dry periods, the gated culverts only discharged at a rate equal to the allowable rate less spillway discharge, divided equally between the two gated culvert outlets. To achieve this, both the west and east cell gated culverts were modeled as separate pump stations in HEC-RAS and pump rule operations were set for each pump. Pump rules were written so that they were only operable during the dry period time steps and only when the cell stage was greater than the NFSL. When the pumps were allowed to operate, the rules were written to allow the total discharge (controlled and uncontrolled) to equal the calculated allowable discharge for the reservoir. This calculation was performed within HEC-RAS for each 15-minute time step. A summary of the pump rules is provided in Table 6.

Table 5. Summary of Pump Rules to Simulate Gated Outflow Culverts

Scenario 1		Scenario 2		East Cell Pump Discharge	West Cell Pump Discharge
Period Condition	Duration (Hours)	Period Condition	Duration (Hours)		
30% PMP	0-72	40% PMP	0-72	Pump Off	Pump Off
3-day Dry	72-144	5-day Dry	72-192	1,500 cfs less E spillway and W spillway discharge at time step (cfs) divided by 2, when cell stage > NFSL	1,500 cfs less E spillway and W spillway discharge at time step (cfs) divided by 2, when cell stage > NFSL
100% PMP	144-216	100% PMP	192-264	Pump Off	Pump Off
10-day Dry	216-456	10-day Dry	264-504	1,500 cfs less E spillway and W spillway discharge at time step (cfs) divided by 2, when cell stage > NFSL	1,500 cfs less E spillway and W spillway discharge at time step (cfs) divided by 2, when cell stage > NFSL
30% PMP	456-528	40% PMP	504-576	Pump Off	Pump Off
No Additional Inflow	528-552	No Additional Inflow	576-600	Pump Off	Pump Off

3.2.3.5 East and West Spillway Widths

Each cell has an ungated overflow spillway with a crest elevation set at the NSFL (51.7 ft-NAVD). Both cell spillways are located downstream of S-83 and discharge into the C-41A Canal. Prior to simulating the PMF, both the east and west cell spillway widths were adjusted iteratively in HEC-RAS, in order to maximize discharge, while still remaining under the calculated allowable peak discharge to the C-41A. The spillway widths were adjusted using Scenario 1 flow data, as this scenario produces larger peak discharges in comparison to Scenario 2. A weir coefficient of 2.6 was used for the spillways. The maximum spillway widths are summarized in Table 7.

Table 6. LOCAR Recommended Plan Spillway Maximum Widths

Reservoir Cell	Maximum Spillway Width (feet)
West	29.1
East	29.1

3.3 PMF Routing Results

The results from routing the PMF for Scenarios 1 and 2 are presented in Table 8. Table 8 presents the simulated spillway peak discharge, the simulated maximum stage, and the peak time of occurrence for Scenarios 1 and 2.

Table 7. Spillway Peak Discharge Rates for Scenario 1 and 2

Scenario	Cell	Simulated Spillway Peak Discharge (cfs)	Simulated Maximum Stage (ft-NAVD)	Time of Occurrence of Simulated Spillway Peak Discharge and Maximum Stage (hr)
1	West	746	56.3	216.00
	East	747	56.3	216.00
	Total	1,492	-	-
2	West	723	56.2	264.00
	East	724	56.2	264.00
	Total	1,447	-	-

Figure 3 (Scenario 1) and Figure 5 (Scenario 2) show the relationship between the rain inflow and the reservoir output. Reservoir output is shown split between gate flow and weir flow (spillway), as well as a total combined outflow, not to exceed the aforementioned peak discharge limit of 1,500 cfs.

Figure 4 (Scenario 1) and 6 (Scenario 2) show the relationship between total reservoir outflow and cell stage.

The simulated maximum stage was kept within the top of the reservoir embankments for both scenarios, while also maintaining a total peak discharge below the allowable total discharge; however, the stages did not recover back to the NSFL within the simulation period.

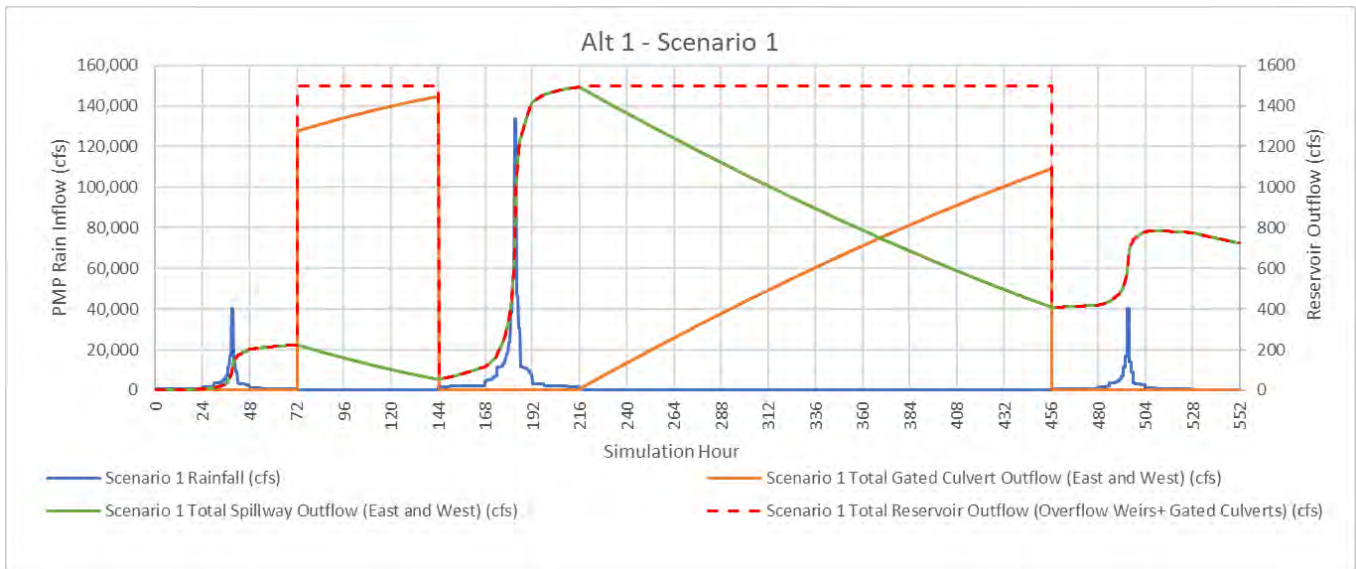


Figure 3. Rain Inflow and Reservoir Outflow for Scenario 1

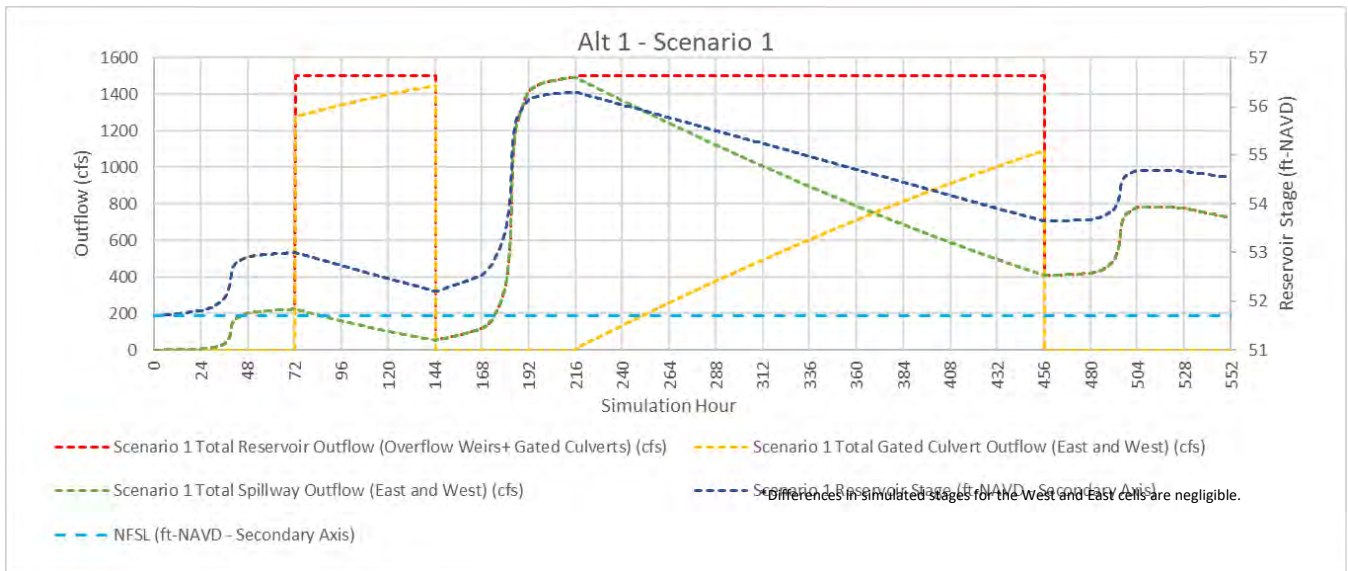


Figure 4. Reservoir Outflow and Stage for Scenario 1

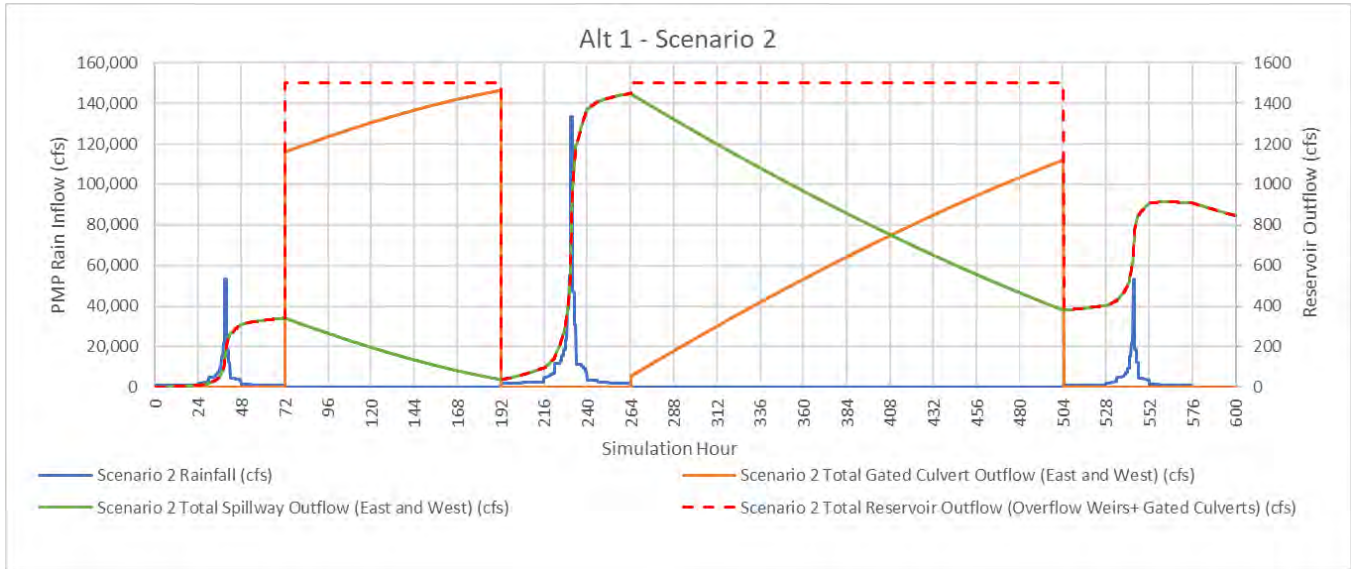


Figure 5. Rain Inflow and Reservoir Outflow for Scenario 2

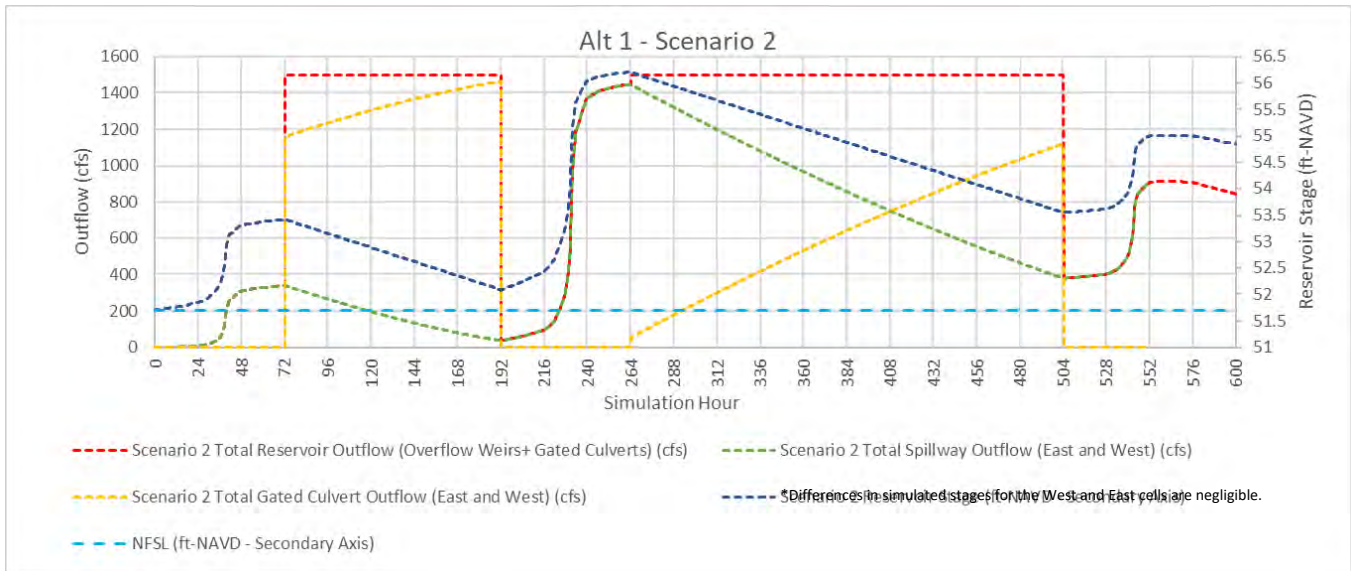


Figure 6. Reservoir Outflow and Stage for Scenario 2

Prepared for:	South Florida Water Management District
Prepared by:	J-Tech, an Alliance between Jacobs Engineering and Tetra Tech, Inc.
Date:	January 2024
Subject:	Lake Okeechobee Component A Storage Reservoir Feasibility Study Wave and Overtopping Analysis

1.0 Introduction

1.1 Background

The Lake Okeechobee Component A Storage Reservoir (LOCAR) Project is currently being undertaken as part of the Comprehensive Everglades Restoration Plan (CERP), an approved framework for restoring the South Florida ecosystem while providing for other water-related needs of the region. The purpose of the LOCAR Project is:

- to store excess water in the northern watersheds for release at times when it is beneficial,
- to improve Lake Okeechobee’s ecology by reducing the duration and frequency of high water levels, and
- to reduce the likelihood of harmful releases from Lake Okeechobee to the northern estuaries.

As part of this project, the South Florida Water Management District (SFWMD) is undertaking a feasibility assessment for the design and construction of the LOCAR. J-Tech has been engaged to undertake wave modelling and an overtopping analysis to support this feasibility assessment. This memo documents the procedure and outcomes of this analysis.

1.2 LOCAR

1.2.1 General Layout

The LOCAR Alternative 1 site is located in Highlands County, Florida. It is situated approximately 15 miles north west of Lake Okeechobee (**Figure 1-1**).

Early development of Alternative 1 included an approximately 12,000 acre reservoir (measured as the area contained within the centerline of the perimeter dam) with a Normal Full Storage Level (NFSL) of 50.6 NAVD88 with a total storage capacity of 200,000 acre-feet. The reservoir is sited on the Bassinger Tract as indicated in **Figure 1-2**. A recently identified, ecologically sensitive area, within the footprint of the original proposal required modifications to the footprint on the same tract. Omission of this area (approximately 480 acres) from the reservoir footprint results in a slightly smaller areal footprint with a corresponding increase in the NFSL, from 50.6 to 51.7 feet NAVD88, to maintain the required reservoir capacity at 200,000 acre-feet.

Figure 1-3 presents the revised proposed layout omitting the Ecologically Sensitive Area. The initial analysis in the draft version of this Technical Memorandum (TM) was performed based on the layout shown in **Figure 1-2**. This analysis was updated to capture the change in the NFSL in this TM for the layout shown in **Figure 1-3**. To expedite the study, it should be noted, however, that certain features of

the analysis were still based on the previous reservoir configuration as they were considered to have minimal impacts on the assumptions used for the feasibility level of analysis.

The reservoir covers an extent of approximately 6 miles (east to west) by 4 miles (north to south) as shown in **Figure 1-3**. An East and West Cell are proposed for the reservoir which are separated by a divider dam.



Figure 1-1 Location of LOCAR Alternative 1

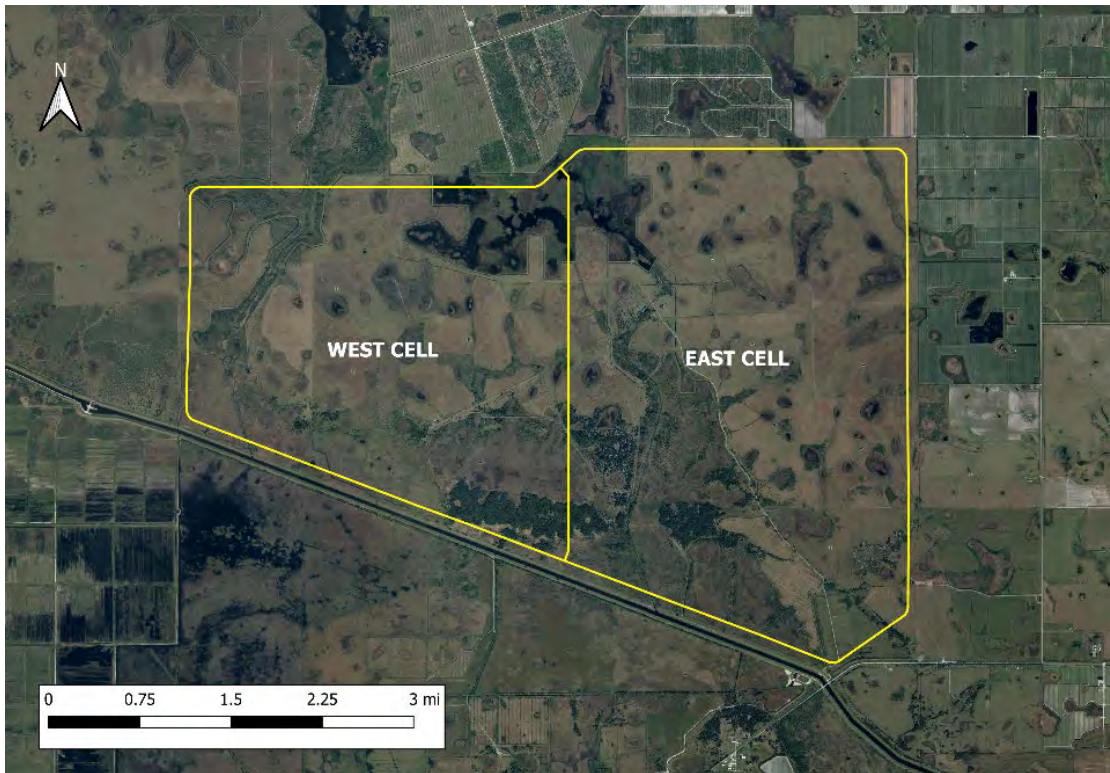


Figure 1-2 Original layout of LOCAR Alternative 1

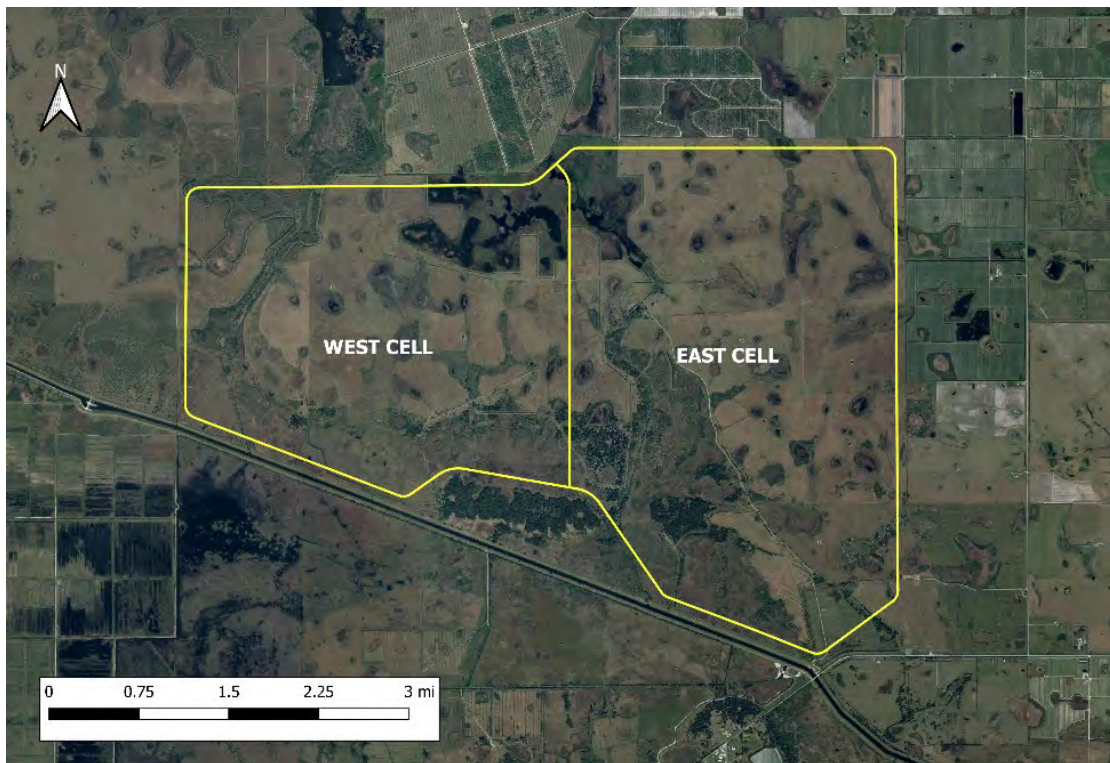


Figure 1-3 Revised layout of LOCAR Alternative 1

1.2.2 Embankment Characteristics

Figure 1-4 illustrates the cross-sectional design of the LOCAR embankment which was used for the overtopping analysis. A slope of 1:3 (vertical to horizontal) is proposed for inner and outer slopes of the embankment, with a 16-inch thick soil cement layer to be constructed on the inner slope and a 6-inch thick layer of topsoil installed on the outer slope. Recent design developments have included removal of the wave wall on the embankment crest to mitigate the risk of obstructing wildlife movements from/to the reservoir. The required crest elevation of the embankment to meet acceptable overtopping limits has been investigated as part of this assessment.

The NFSL of the reservoir is at an elevation of 51.7 ft NAVD88. A borrow area is located inside the perimeter of both the East and West Cells.

Lake Okeechobee Component A Storage Reservoir Wave and Overtopping Analysis

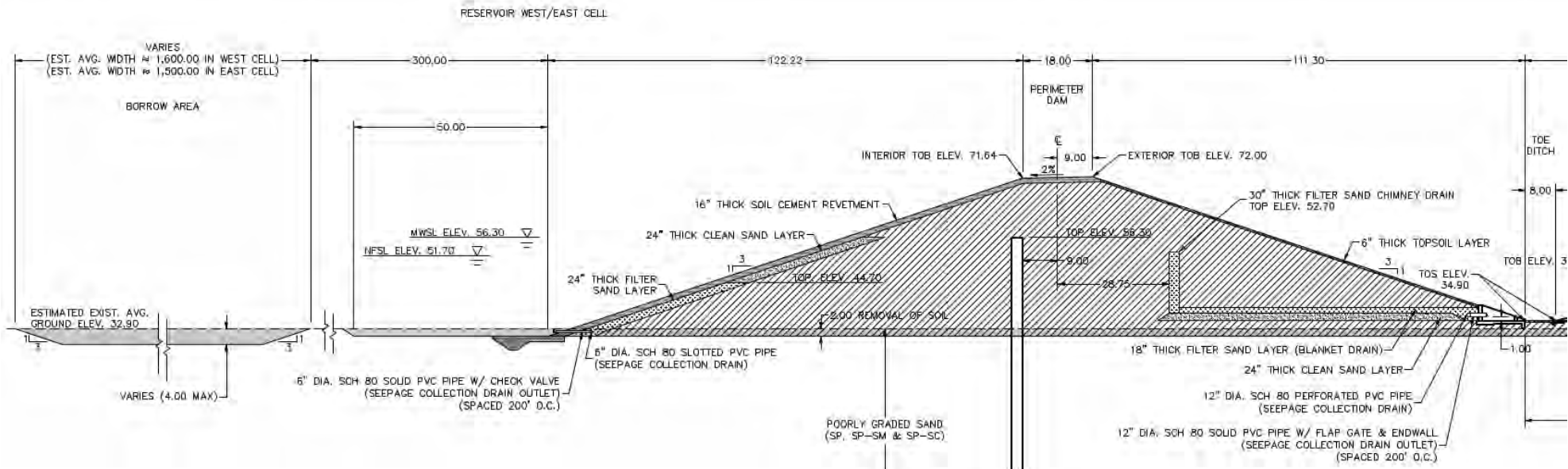


Figure 1-4 Typical cross section for the LOCAR embankment

1.2.3 Cell Fetch Length

The maximum fetch length for both the East and West Cell was estimated based on the recommended approach outlined in DCM-2, i.e. the average of 9 radials constructed at 3 degree intervals as shown in **Figure 1-5**.

For the original layout, the maximum fetch length for the East Cell was calculated to be approximately 4.4 miles based on a point of interest in the north west corner of the cell. A slightly shorter maximum fetch length of 3.95 miles was calculated for the West Cell based on a point of interest in the south east corner of the cell.

The fetch length for the revised layout remains unchanged for the East Cell as shown in **Figure 1-5**. The maximum fetch length for the West Cell reduces slightly to 3.67 miles.

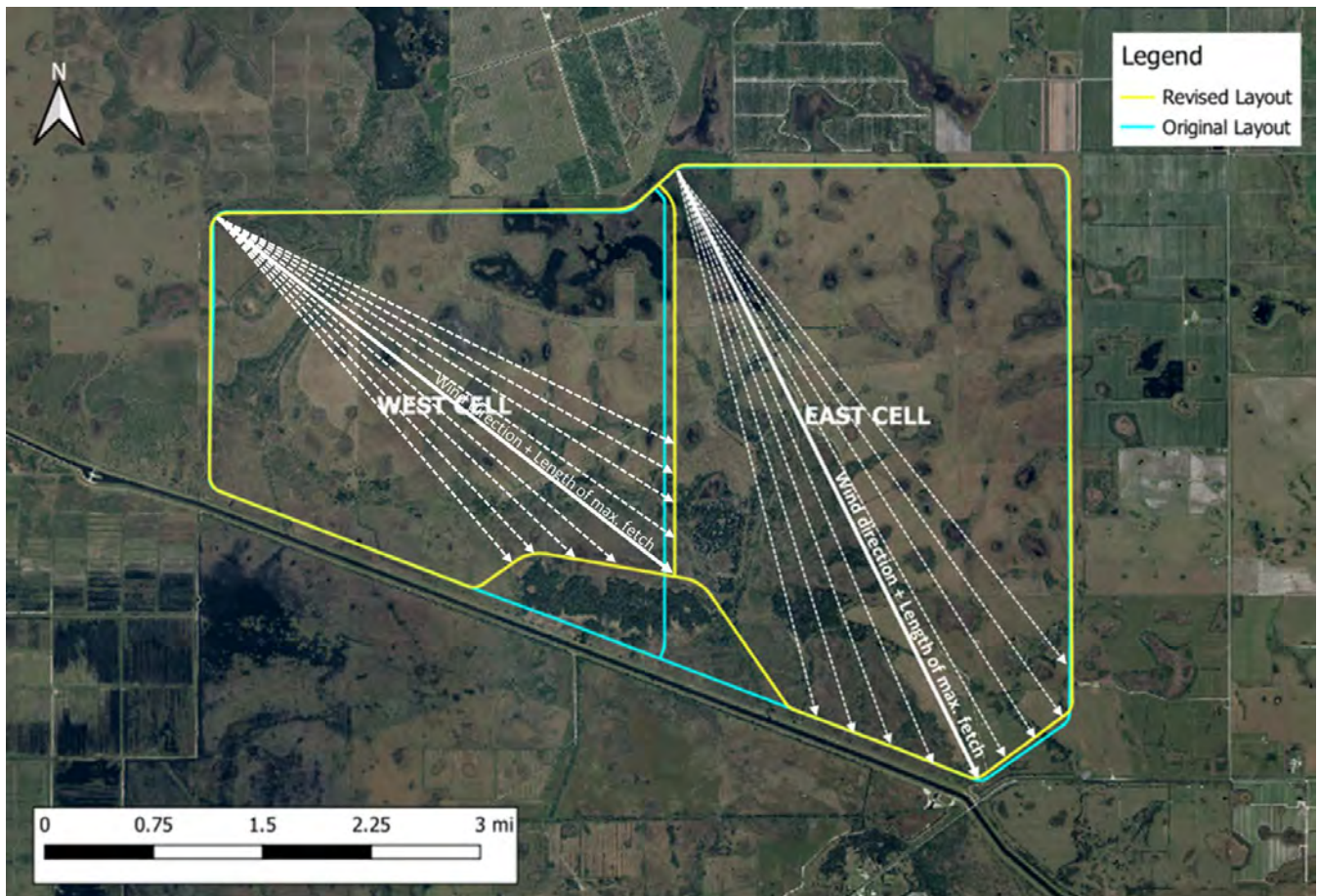


Figure 1-5 Maximum fetch length for the East Cell based on 9 radials at 3 degree intervals

1.3 Objectives

Objectives of this study are as follows:

- a) To estimate the maximum wave conditions generated across the LOCAR during extreme design wind events through wave transformation modeling (STWAVE); and

- b) Assess the embankment crest elevation based on the predicted volume of overtopping for the design wave conditions using empirical methods (EurOtop).

2.0 Design Storm Events

Four combinations of extreme winds and precipitation, as described in DCM-2 (Haapala et al., 2006), were used to provide a preliminary assessment of the design wave conditions for the design of the reservoir embankments, and the evaluation of the associated wave overtopping volumes. Details regarding these conditions are summarized below.

2.1 Design Case 1: PMP combined with 100-year wind

Design Case 1, as documented in the routing analysis included in J-Tech (2023), assumes an event that includes a series of three major storm events, including a storm with the Probable Maximum Precipitation (PMP) and a 100-year Average Recurrence Interval (ARI) wind acting on the reservoir during the peak water level in the reservoirs. The maximum still water elevation was determined based on a routing analysis that assumed:

- Routing starts when the reservoir is at the Normal Full Storage Level (NFSL) of 51.7 feet NAVD88.
- The maximum discharge from the 17.8 square mile reservoir into the C-41A Canal is 1500 cubic feet per second (cfs).
- 30 percent of the 72-hour PMP (16.18 inches) falls during the first storm in the first 72 hours. Gated structures are closed.
- A 3-day dry interval occurs. Gated structures open and discharge at a combined rate of 1500 cfs.
- 100 percent of the 72-hour PMP (53.94 inches) falls during the second storm. Gated structures are closed.
- A 10-day dry interval occurs. Gated structures open and discharge at a combined rate of 1500 cfs.
- 30 percent of the 72-hour PMP (16.18 inches) falls during the third storm. Gated structures are closed.

The procedure described in DCM-2 (Haapala et al., 2006) was followed to provide an estimate of the 100-year ARI wind speed magnitude for the LOCAR. As specified in DCM-2, the 50-year three second wind gust for the LOCAR site is 112 miles per hour (mph), which converts to approximately 120 mph for a 100-year three second wind gust. This matches the latest ASCE/SEI 7-22 (American Society of Civil Engineers, 2022) 100-year wind gust estimates for the region.

The 100-year gust wind speed was converted to a 100-year one hour overwater wind speed of approximately 95.3 mph. After adjustments for duration and overwater conditions, the sustained wind speed magnitude was estimated to be 94.9 mph for the East Cell, and 95.3 mph for the West Cell (for both the original and revised layout).

2.2 Design Case 2: 100-Year Precipitation combined with category 5 hurricane winds

Design Case 2 represents a 100-year precipitation event in combination with a Category 5 wind speed as defined by the Saffir-Simpson Hurricane Scale.

A 100-year precipitation event of 10.9 inches has been adopted for this design case which is based on the NOAA Atlas 14 rainfall estimate for the site location. This is slightly lower than the 100-year precipitation event rainfall

of 12 inches from Figure DCM 2-3 of DCM-2 (Haapala et al. 2006). The NOAA Atlas 14 rainfall depth was selected because it is based on more recent historical rainfall data than the DCM-2 rainfall depth.

As recommended in DCM-2, a one-minute overwater wind speed of 156 mph was used to represent a Category 5 hurricane. After adjustments for duration to achieve fully developed wave conditions over the reservoir cell fetch lengths, the sustained wind speed magnitude was estimated to be 125.1 mph for the East Cell and 125.2 mph for the West Cell (for both the original and revised layout).

2.3 Design Case 3: Probable maximum wind speed

Design Case 3 represents the Probable Maximum Wind (PMW) speed in combination with the reservoir level at the normal full storage depth (i.e. approximately 17.6 ft for the LOCAR). As recommended in DCM-2, this particular design case was used for sensitivity testing only and not as a selected design condition (Haapala et al., 2006):

[The probable maximum wind...] is to be used for “sensitivity identification” and not as a design condition. Wave models are unlikely capable of yielding results within a degree of confidence for design for these extreme wind speeds, especially over relatively shallow water bodies. Even for 125-mph wind, model capabilities are most likely being “stretched” for project conditions.

As defined in DCM-2, a one minute averaged overwater wind speed of 200 mph was used to represent the PMW. The one minute average wind speed was converted to an hourly averaged wind speed of 161 mph. After adjustments for duration, the sustained wind speed magnitude was estimated to be 161.3 mph for the East Cell and 161.5 mph for the revised West Cell layout (161.4 mph for the original layout).

2.4 Design Case 4: Storm specific wind and precipitation

Design Case 4 represents a storm specific case of precipitation and wind conditions recorded during Hurricane Easy which occurred in Florida in 1950.

Precipitation depths for both the 24-hour and 72-hour rainfall durations are considered in this analysis, corresponding to 38.7 inches and 45.2 inches respectively (Haapala et al., 2006).

A maximum wind speed of 125 mph (3 second gust) was recorded during Hurricane Easy (Haapala et al., 2006). After adjustments to meet DCM-2 requirements (i.e. overwater conditions, wind duration for wave development etc.) the sustained wind speed magnitude was estimated to be 99.1 mph for the East Cell and 99.4 mph for the West Cell (for both the original and revised layout).

2.5 Summary

Table 2-1 summarizes the wind and precipitation design conditions for both the East and West Cell based on the revised layout.

Table 2-1 Wind and precipitation design conditions

Design Case	Description	Wind East Cell (mph)	Wind West Cell (mph)	Precipitation (inches)	East Cell Average Water Depth ¹ (ft)	West Cell Average Water Depth ¹ (ft)
1	100 yr ARI wind + PMP	94.9	95.3	86.3 ²	22.3	22.6
2	Cat 5 Hurricane + 100yr ARI Precipitation	125.1	125.2	10.9	18.6	18.9
3	Probable Max Wind Speed (Sensitivity Testing Only)	161.3	161.5	0	17.7	18.0
4.1	Storm Specific Wind & 24hr Precipitation (Hurricane Easy)	99.1	99.4	38.7	20.9	21.2
4.2	Storm Specific Wind & 72hr Precipitation (Hurricane Easy)	99.1	99.4	45.2	21.5	21.8
<p>1. Average water depth = [NFSL (51.7 ft NAVD88) – Average Ground Elevation (34 ft NAVD88 East Cell; 33.7 ft NAVD88 West Cell)] + Precipitation; with the exception of Design Case 1 where the Average water depth = PMF water level for Design (56.3 ft NAVD88) - Average Ground Elevation (34 ft NAVD88 East Cell; 33.7 ft NAVD88 West Cell)]</p> <p>2. The probable maximum precipitation equals 53.94 inches. The precipitation for Design Case 1 is based on the occurrence of three consecutive storms, with the first and third, each bringing 30% of the PMP and the second bringing the full PMP.</p>						

3.0 Wave Modeling Analysis

3.1 Introduction

Wave transformation modeling was undertaken to provide a preliminary assessment of the design wave conditions for the LOCAR. The USACE’s STWAVE analysis software was used to model wave growth across the reservoir during the design storm events described in Section 2.0. Details regarding the model setup, results, and validation are discussed below.

3.2 STWAVE Model

STWAVE Version 3.4 was used for this analysis via the Coastal Engineering Design and Analysis System (CEDAS), an interactive analysis system focused on the fields of coastal, ocean, and hydraulic engineering. STWAVE is a steady-state finite difference model based on the wave action balance equation. The model considers time-independent advection, refraction shoaling, and wave growth as a function of winds. It is a half-plane model, i.e. it only includes spectral energy directed into the computational grid at the seaward boundary (Smith et al., 2001). The specification of bottom friction is excluded from this version of STWAVE.

3.3 Model Setup

3.3.1 Model domain

STWAVE performs computations over a regular computational grid. The domain was developed based on the original LOCAR layout. As shown in **Figure 1-5**, the difference in the maximum fetch length is negligible between the original and revised reservoir layouts (i.e. 4.4 miles in the East Cell). Hence, given the time constraints, it was

deemed acceptable to use the original domain for the analysis of the revised reservoir as the maximum design wave conditions are generated over the same fetch (refer to Section 3.4).

The latest Highlands County 2018 USGS LiDAR Digital Elevation Model was used as input into the model domain. A borrow area was incorporated into the model, and areas outside the reservoir footprint were designated as ‘dry’ by setting the grid elevation above the design water level. A 60-ft grid resolution was adopted throughout the model domain.

STWAVE operates in a local coordinate system, with the x-axis oriented in the cross-shore (i.e. wave propagation) direction and the y-axis oriented alongshore to form the “offshore” boundary. For wind directions greater than 60 degrees relative to the x-axis, this version of STWAVE underpredicts wave generation due to the half-plane model functionality (Smith et al., 2001). Hence, model grids were generated such that the x-axis aligned with the wind direction within +/- 60 degrees.

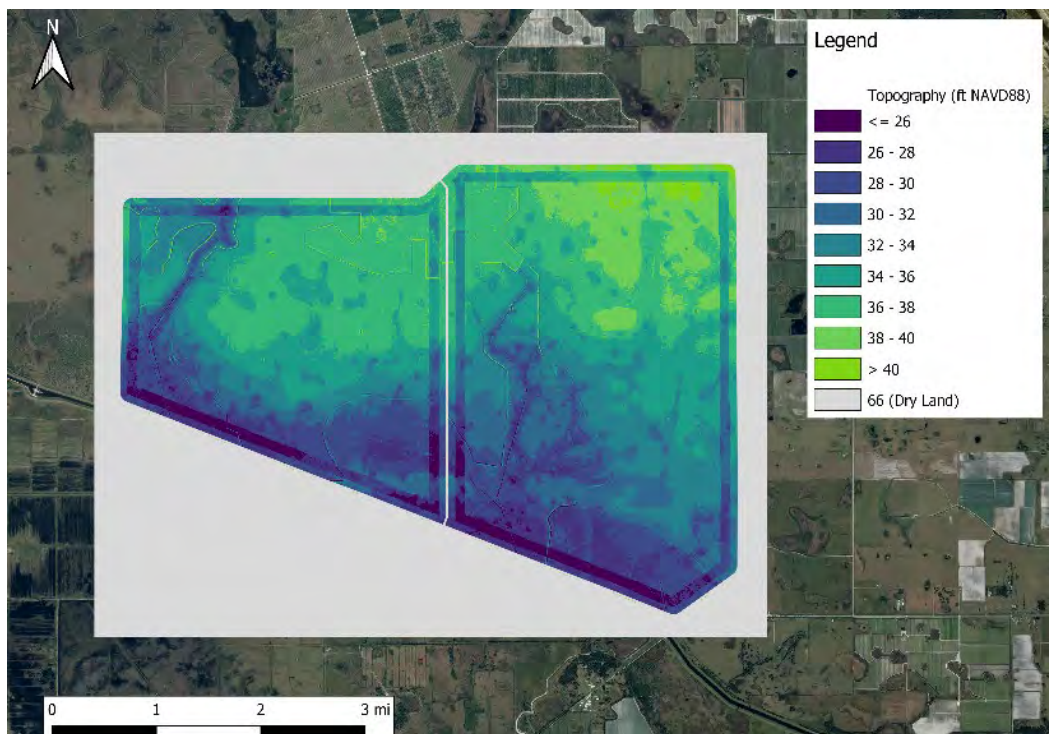


Figure 3-1 STWAVE model topography and grid extents

3.3.2 Water levels

Water levels for the design storm events summarized in Section 2.0 were included in the model, with an additional allowance for wind setup. Wind setup is caused by shear stress exerted on the water surface, which in turn causes a slope in the water surface resulting in a water level increase at the leeward side of the reservoir. This setup level influences the water depth at the reservoir embankment, and therefore can impact the wave conditions within the reservoir as well as the overtopping discharge.

Wind setup was calculated using the Zeider Zee method (USACE, 1997), which is the recommended empirical method for reservoirs with depths equal to or greater than 16 feet as per DCM-2 (Haapala et al., 2006). This method calculates wind setup based on wind speed, fetch length and depth. Table 3-1 and **Table 3-2** summarize

the estimated wind setup for each of the DCM-2 design cases for the East and West Cells respectively, as well as the resulting maximum water depth and elevation at the leeward side of the reservoir.

The maximum water elevation was applied as input into the STWAVE model based on the slightly higher results for the East Cell. This is a conservative approach as wind setup is applied to the whole reservoir, however in reality setdown would decrease water depths at the upstream end and hence could reduce wave growth. Sensitivity tests suggests that the overall impact of this setdown will have minor impacts on the overtopping analysis and embankment crest level (likely less than 0.3 ft – refer to **Table 3-3**).

Table 3-1 Summary of calculated wind setup – East Cell

Design Case	Wind (mph)	Effective Water Depth ¹ (ft)	Maximum wind setup ² (ft)	Maximum water depth ³ (ft)	Maximum Water Elevation ⁴ (ft NAVD88)	Freeboard to TOB water side ⁵ (ft)
1	94.9	22.3	1.3	23.6	57.6	14.0
2	125.1	18.6	2.6	21.2	55.2	16.4
3 (Sensitivity Testing)	161.3	17.7	4.5	22.2	56.2	15.4
4.1	99.1	20.9	1.5	22.4	56.4	15.2
4.2	99.1	21.5	1.4	22.9	56.9	14.7

1. Based on assumed average ground level of 34 ft NAVD88 and water surface level elevation = NFSL (51.7 ft) + Precipitation; with the exception of the PMF water level (56.3 ft NAVD88) which is based on results from the PMP Routing Assessment
2. Maximum wind setup calculated based on maximum fetch length of 4.4 miles
3. Maximum water depth = Effective water depth + Wind setup
4. Maximum water elevation based on assumed average ground level of 34 ft NAVD88 for the East Cell
5. Freeboard to Top of Bank (TOB) water side = TOB water side elevation (71.64 ft NAVD88) - Maximum water elevation

Table 3-2 Summary of calculated wind setup – West Cell

Design Case	Wind (mph)	Effective Water Depth ¹ (ft)	Maximum wind setup ² (ft)	Maximum water depth ³ (ft)	Maximum Water Elevation ⁴ (ft NAVD88)	Freeboard to TOB water side ⁵ (ft)
1	95.3	22.6	1.1	23.7	57.4	14.3
2	125.2	18.9	2.2	21.1	54.8	16.8
3 (Sensitivity Testing)	161.5	18.0	3.8	21.8	55.5	16.1
4.1	99.4	21.2	1.2	22.4	56.1	15.5
4.2	99.4	21.8	1.2	23.0	56.7	14.9

1. Based on assumed average ground level of 33.7 ft NAVD88 and water surface level elevation = NFSL (51.7 ft) + Precipitation; with the exception of the PMF water level (56.3 ft NAVD88) which is based on results from the PMP Routing Assessment
2. Maximum wind setup calculated based on maximum fetch length of 3.67 miles
3. Maximum water depth = Effective water depth + Wind setup
4. Maximum water elevation based on assumed average ground level of 33.7 ft NAVD88 for the West Cell
5. Freeboard to TOB water side = TOB water side elevation (71.64 ft NAVD88) - Maximum water elevation

Table 3-3 Wind setup sensitivity tests

Scenario ¹	Modelled Water Level (ft NAVD88) ²	Wave Conditions ³	Embankment Height required to achieve 0.05 cfs/ft ⁴
2.6 ft setup applied across full model	55.2	Hmo=10.3ft Tp=5.6s	72.0ft
0 ft setup applied across full model	52.6	Hmo=10.0ft Tp=5.6s	71.7ft
2.6 ft setback applied across full model	50.0	Hmo=9.8ft Tp=5.6s	71.5ft
<ol style="list-style-type: none"> 1. Sensitivity tests undertaken for worst case wind setup/setback scenarios based on Design Case 2 2. Maximum water level for Design Case 2 including wind setup/set 3. Wave Conditions are for the East Cell Design Case 2 (worst case condition – Refer to Section 3.4) 4. Refer to overtopping analysis details in Section 4.0 			

3.3.3 Incident Wave Spectrum

A single input wave spectrum was applied at the “offshore” boundary of the STWAVE grid. Forty frequency bins were used with an initial frequency of 0.04 Hertz (Hz) and a frequency increment of 0.02 Hz. The spectrum on the “offshore” boundary was specified as zero, i.e. Hmo = 0 ft, to force all wave energy to be developed from the wind. The period, T, was set at 1.25 seconds (s) to represent the peak frequency of 0.8 Hz (i.e. set to the highest frequency because there is no energy in the input spectrum). The water depth was set at the maximum water depth for each Design Case (refer to **Table 3-1**).

3.3.4 Wind

Spatially constant overwater wind speeds were applied within the STWAVE model for each Design Case based on the slightly more conservative winds estimated for the West Cell (as defined in **Table 3-2**).

To identify the most conservative wind scenario, multiple wind directions were tested in the model (at 22.5 degree increments) for Design Case 2, as well as a wind direction aligned with the longest fetch length (i.e. wind coming from ~333.5° True North).

3.4 Results

The maximum design wave conditions generated at the perimeter of the eastern and western cells are summarized below in Table 3-4. These results are based on the most conservative wind direction for both cells (i.e. wind from 333.5° TN for the East Cell and wind from the north west for the West Cell).

Based on the STWAVE results, maximum wave heights for the design conditions range from 8.1 ft to 10.3 ft in the East Cell, with peak wave periods from 5.0 s to 5.6 s. Maximum wave conditions in the West Cell range from 7.6 ft to 9.7 ft, with peak wave periods from 4.5 s to 5.6 s. Results for the West Cell may be slightly conservative due to the reduction in fetch length with the revised layout.

Table 3-4 Reservoir wave prediction results

Design Case	Wind (mph)	East Cell		West Cell	
		Significant Wave Height, Hmo (ft)	Peak Wave Period, Tp (s)	Significant Wave Height, Hmo (ft)	Peak Wave Period, Tp (s)
1	95.3	8.1	5.0	7.6	4.5
2	125.2	10.3	5.6	9.7	5.6
3 (Sensitivity Testing)	161.5	12.4	6.2	11.4	6.2
4.1	99.4	8.3	5.0	7.8	5.0
4.2	99.4	8.4	5.0	7.8	5.0

Results from a directionality assessment undertaken for Design Case 2 are summarized below in **Table 3-5**. Example outputs from the model are shown in **Figure 3-2 to Figure 3-5**.

Table 3-5 Design Case 2: Wind directionality assessment results

Wind Direction (Coming From)	East Cell		West Cell	
	Maximum Significant Wave Height, Hmo (ft)	Peak Wave Period, Tp (s)	Maximum Significant Wave Height, Hmo (ft)	Peak Wave Period, Tp (s)
N	10.1	5.6	8.8	5.0
NNE	9.8	5.6	8.6	5.0
NE	9.8	5.6	9.2	5.0
ENE	9.2	5.0	9.2	5.0
E	8.8	5.0	9.1	5.0
ESE	8.9	5.0	9.0	5.0
SE	8.2	5.6	8.8	5.6
SSE	8.0	5.0	8.0	5.6
S	7.9	5.6	7.7	5.0
SSW	7.4	5.6	7.8	5.0
SW	8.1	5.0	8.0	5.0
WSW	8.5	5.0	8.2	5.0
W	8.5	5.0	8.8	5.0
WNW	8.7	5.0	8.9	5.0
NW (Max Wave Conditions West Cell)	9.5	5.6	9.7	5.6
NNW – 333.5° TN (Max. Wave Conditions East Cell)	10.3	5.6	9.2	5.0
NNW	10.2	5.6	9.2	5.0

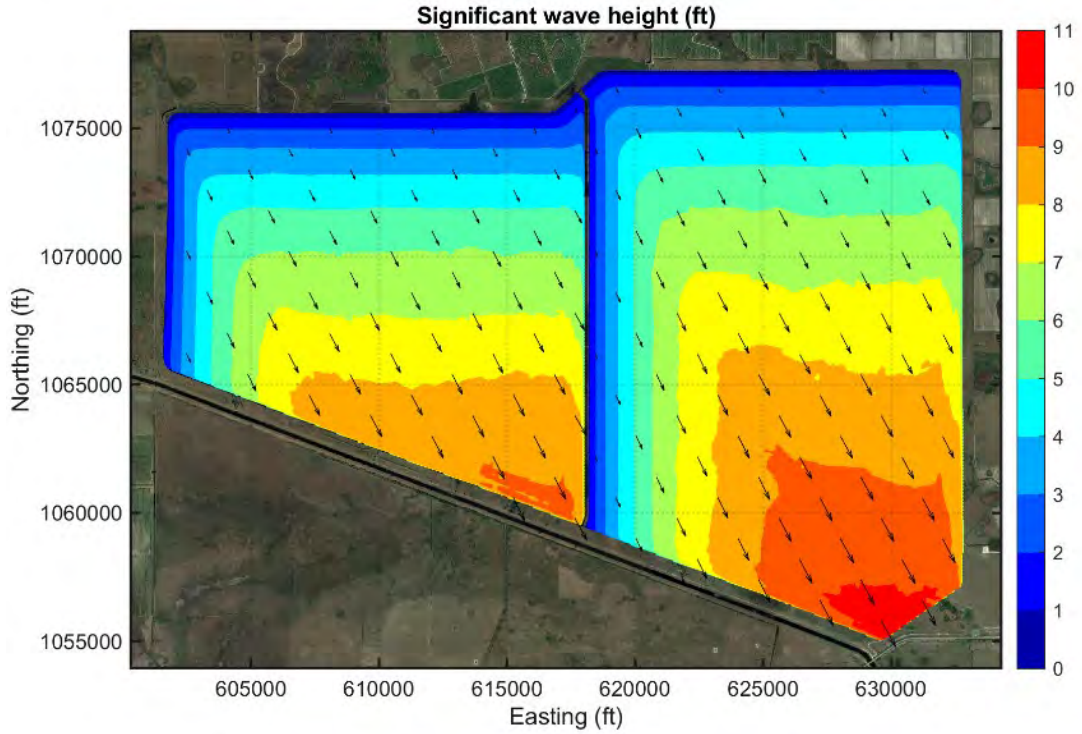


Figure 3-2 Design Case 2: Resulting significant wave height for the worst case wind direction for the East Cell (NNW - 333.5° TN)

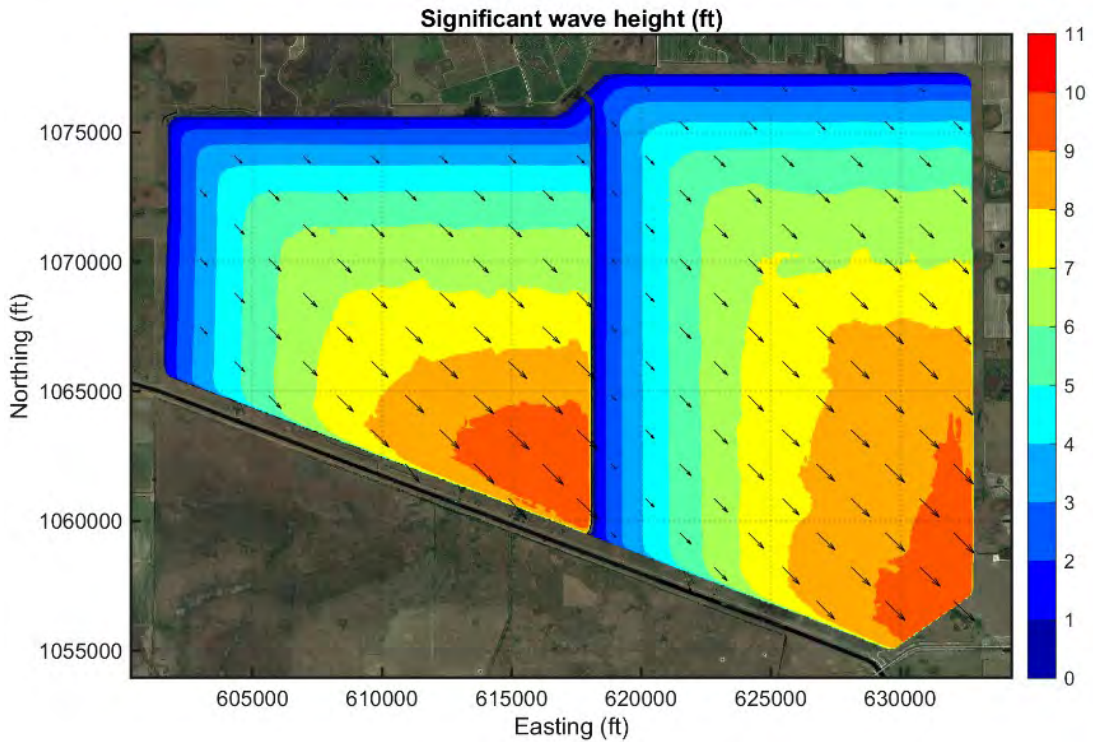


Figure 3-3 Design Case 2: Resulting significant wave height for the worst case wind direction for the West Cell (NW)

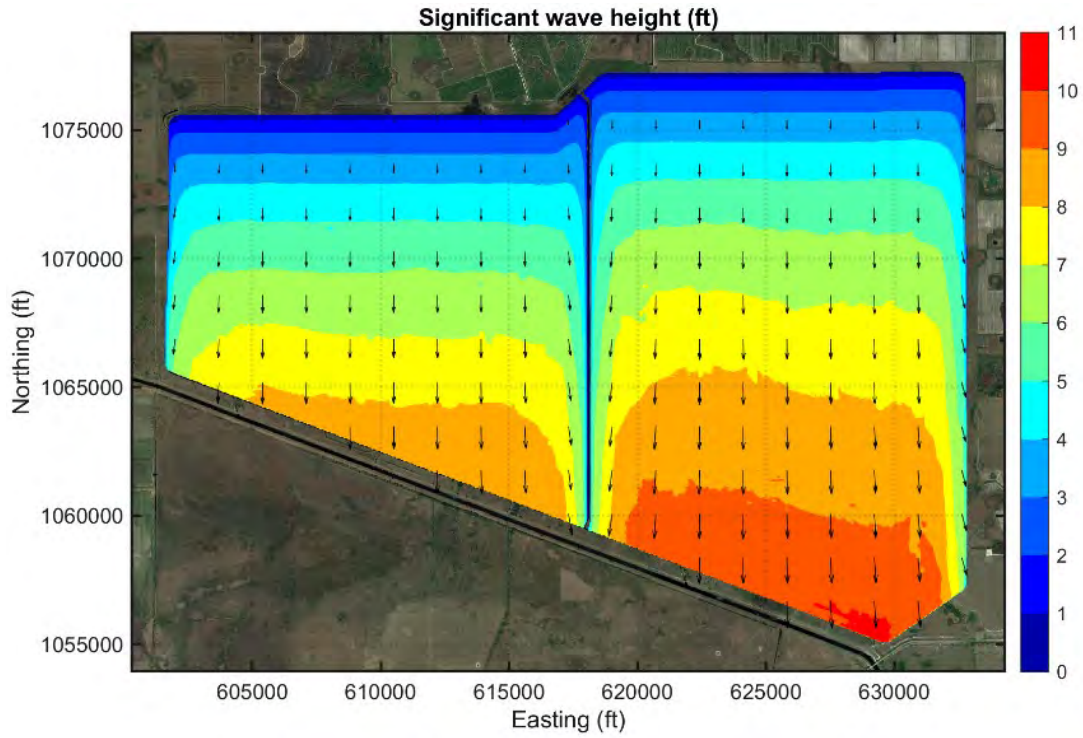


Figure 3-4 Design Case 2: Resulting significant wave height for a northerly wind direction

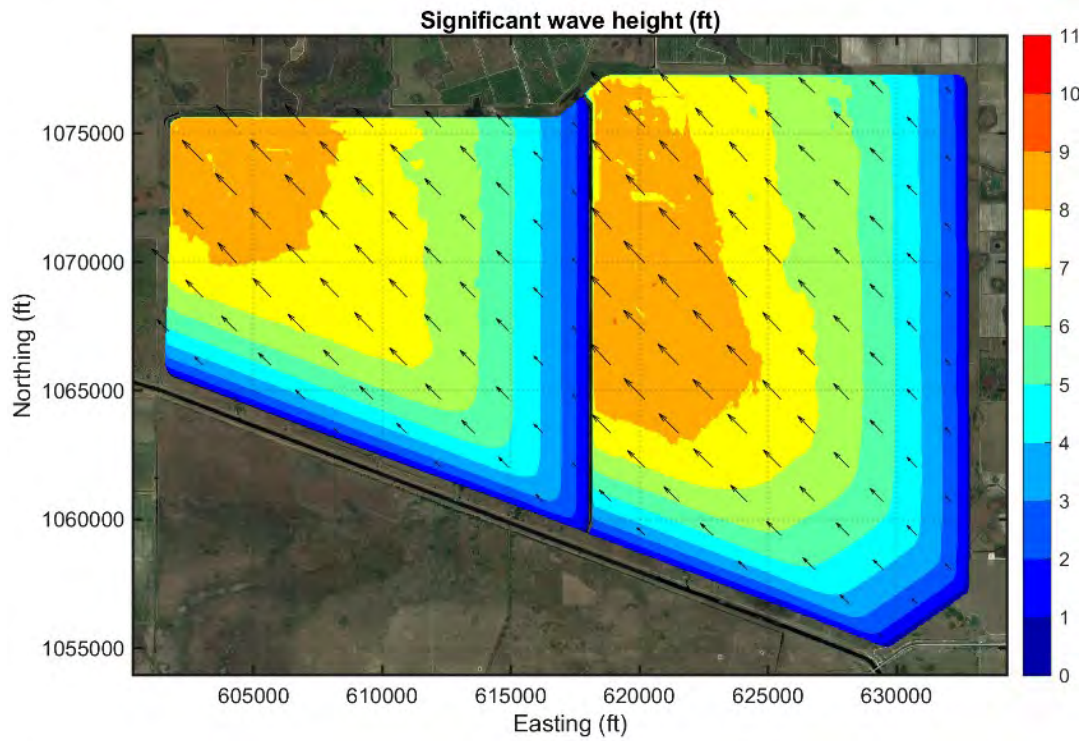


Figure 3-5 Design Case 2: Resulting significant wave height for a south easterly wind direction

3.5 Model Verification

The maximum wave conditions predicted using STWAVE for the East Cell were verified against the SPM 1984 empirical methodology as recommended by DCM-2, as well as Automated Coastal Engineering System (ACES) models run at the increased water level (i.e. including wind setup).

The SPM 1984 methodology advances shallow water wave prediction formulae presented in SPM 1977 (SMB wave prediction curves) to include an intermediate calculation of wind stress and be consistent with the JONSWAP formulae. The calculations estimate the wind generated wave climate based on the fetch length, water depth, and wind stress.

The ACES package forms part of the Coastal Engineering Design and Analysis System (CEDAS), an interactive analysis system focused on the fields of coastal, ocean, and hydraulic engineering. The wind adjustment and wave growth module of ACES was used to estimate wave conditions within the East Cell of the LOCAR. This module provides estimates for wave growth over open-water and restricted fetches in both deep and shallow water based on a function of wind speed, fetch, and water depth. The methods used are primarily based on those of Vincent (1984), the SPM (1984), and Smith (1991).

The results from the verification analysis indicate that the wave height and period estimates produced from the STWAVE model correlate well with those predicted using the SPM 1984 methodology and ACES analysis (Table 3-6). In general, the model results are slightly higher than those predicted from the analytical equations.

Table 3-6 STWAVE model verification

Design Case	STWAVE		SPM 1984		ACES	
	Maximum Significant Wave Height, Hmo (ft)	Peak Wave Period, Tp (s)	Maximum Significant Wave Height, Hmo (ft)	Peak Wave Period, Tp (s)	Maximum Significant Wave Height, Hmo (ft)	Peak Wave Period, Tp (s)
1	8.1	5.0	7.9	4.5	7.5	5.0
2	10.3	5.6	9.7	5.0	9.7	5.8
3 (Sensitivity Testing)	12.4	6.2	12.4	5.6	12.7	6.7
4.1	8.3	5.0	8.0	4.6	7.7	5.1
4.2	8.4	5.0	8.1	4.6	7.8	5.1

4.0 Overtopping Analysis

4.1 Introduction

Wave overtopping is an important parameter in determining appropriate freeboard levels for reservoirs. The volume of water that may flow over the crest of the structure during storm events is dependent on hydrodynamic parameters (wave height and period, angle of wave attack and, water depth), as well as the characteristics of the embankment (e.g. crest height, roughness and slope).

Significant volumes of overtopping discharge can result in structural damage to the crest and leeward side of the embankment, threatening the safety of the reservoir. The following section describes the assessment of the

embankment crest elevation, based on the predicted volume of overtopping for the design wave conditions estimated in STWAVE.

4.2 Methodology

DCM-2 (Haapala et al., 2006) recommends the use of ACES to calculate the wave run-up and overtopping for reservoirs. The ACES software package is based on the methodologies published by Weggel (1976) and Ahrens (1977). Ahrens (1977) is based on results of physical model tests of overtopping due to monochromatic waves. At the time of publication, no guidance for predicting overtopping for irregular wave conditions and the method from Ahrens (1977) was provided as interim guidance until results of laboratory study of runup and overtopping by irregular waves was available. Many advances have subsequently been made in the prediction of wave-run up and overtopping, with the latest recommendations being published in the 2018 revision of the EurOtop Manual (EurOtop, 2018).

The 2018 EurOtop Manual provides specific guidance for estimating the mean overtopping rate at structures similar to the design proposed for the LOCAR (a mild-sloped embankment), and therefore this methodology was adopted in the wave overtopping analysis. The equations used for the analysis were based on those specified for a “deterministic design or safety assessment” approach, which include a partial safety factor of one standard deviation (EurOtop, 2018).

In addition to the mean overtopping discharge rate, the maximum overtopping volume of a single wave was also estimated as per equations provided in the EurOtop Manual (2018). These equations are based on various parameters, including the mean overtopping discharge, storm duration, and the percentage of overtopping waves.

4.3 Design Criteria

4.3.1 Overtopping Limits

Acceptable overtopping limits were specified in terms of the mean overtopping discharge. A mean overtopping discharge limit of 0.05 cfs per lineal foot of embankment was adopted in this analysis based on the findings summarised in J-Tech’s *Assessment of Allowable Wave Overtopping Technical Memorandum (2023)*.

4.3.2 Design water levels and wave conditions

The design water levels and wave conditions adopted for the overtopping analysis are summarized below in **Table 4-1** and **Table 4-2** for the East and West Cell respectively. The maximum water depth including wind setup was used for the analysis. Wave conditions are based on the results of the STWAVE model.

Table 4-1 Design water levels and wave conditions adopted for the overtopping analysis – East Cell

Design Case	Maximum water depth ¹ (ft)	Maximum Water Level Elevation ² (ft NAVD88)	Significant Wave Height, H _{mo} (ft)	Peak Wave Period, T _p (s)
1	23.6	57.6	8.1	5.0
2	21.2	55.2	10.3	5.6
3 (Sensitivity Testing)	22.2	56.2	12.4	6.2
4.1	22.4	56.4	8.3	5.0
4.2	22.9	56.9	8.4	5.0

1. Maximum water depth = Average water depth + Wind setup
 2. Maximum water level elevation = NFSL (51.7 ft) + Precipitation + wind setup; with the exception of Design Case 1 where Maximum water level = PMF water level from the PMP Routing Assessment (56.3 ft NAVD88) + wind setup

Table 4-2 Design water levels and wave conditions adopted for the overtopping analysis – West Cell

Design Case	Maximum water depth ¹ (ft)	Maximum Water Level Elevation ² (ft NAVD88)	Significant Wave Height, H _{mo} (ft)	Peak Wave Period, T _p (s)
1	23.7	57.4	7.6	4.5
2	21.1	54.8	9.7	5.6
3 (Sensitivity Testing)	21.8	55.5	11.4	6.2
4.1	22.4	56.1	7.8	5.0
4.2	23.0	56.7	7.8	5.0

1. Maximum water depth = Average water depth + Wind setup
 2. Maximum water level elevation = NFSL (51.7 ft) + Precipitation + wind setup; with the exception of Design Case 1 where Maximum water level = PMF water level from the PMP Routing Assessment (56.3 ft NAVD88) + wind setup

4.3.3 Structural parameters

The overtopping analysis was based on the cross-sectional design shown in **Figure 1-4** which consists of a slope of 1:3 soil cement material and an 18 ft wide soil cement embankment crest. For the wave overtopping assessment, the embankment and crest is assumed to be smooth and impermeable, a conservative assumption.

4.3.4 Storm duration

The maximum overtopping volume by one single wave during a storm is dependent on the length of time that peak storm conditions prevail. In 2018 J-Tech, as part of the EAA Reservoir A-2 Study, undertook an analysis of historical hurricanes in the South Florida region during the period of 1950 – 2015, based on the best track information included in NOAA’s International Best Track Archive.

Results from this analysis indicate that approximately 95% of the hurricanes move with a forward speed greater than approximately 2.1 mph. Hence, considering the maximum fetch distance of the LOCAR (approx. 4.4 miles), a storm duration of 3 hours was selected as a precautionary estimate of the peak storm duration for the overtopping assessment. Additional details of this analysis are documented in J-Tech’s *A-2 Reservoir Wave and Overtopping Analysis Technical Memorandum* (2018).

4.4 Results

4.4.1 Mean overtopping discharge

Based on the results of the STWAVE modeling, mean overtopping discharges were calculated for varying embankment levels. The results indicate that an exterior top of bank elevation of 72 ft NAVD88 is required to meet the overtopping limit of 0.05 cfs/ft based on the East Cell (which is the critical design case). Results from this assessment are summarized in **Table 4-3**. As per recommendations in DCM-2, Design Case 3 is used for sensitivity testing only and not as a selected design condition.

A conservative approach was adopted for the purposes of the overtopping assessment, assuming the angle of wave attack is perpendicular to the structure. While this is relevant for a localized portion of the embankment which is directly exposed to the longest fetch, the majority of the embankment will be subjected to smaller wave conditions or waves approaching at a greater angle of attack (when considering the design waves generated along the maximum fetch length). Hence it may be possible to reduce the embankment elevation for sections of the reservoir, however it is recommended that this is confirmed with a detailed wave directionality assessment in subsequent design phases.

Table 4-3 Calculated mean overtopping discharge

Exterior Top of Bank Elevation (ft NAVD88)	Design Case	Freeboard (Rc) to exterior top of bank ¹ (ft)		Mean overtopping discharge (cfs/ft)	
		East Cell	West Cell	East Cell	West Cell
71.5	1	13.90	14.10	0.021	0.004
	2	16.25	16.72	0.059	0.037
	3 (Sensitivity Testing)	15.26	16.00	0.360	0.212
	4.1	15.10	15.35	0.012	0.008
	4.2	14.59	14.81	0.018	0.011
72	1	14.40	14.60	0.016	0.003
	2	16.75	17.22	0.048	0.030
	3 (Sensitivity Testing)	15.76	16.50	0.309	0.180
	4.1	15.60	15.85	0.009	0.006
	4.2	15.09	15.31	0.014	0.008
72.5	1	14.90	15.10	0.012	0.002
	2	17.25	17.72	0.039	0.024
	3 (Sensitivity Testing)	16.26	17.00	0.264	0.152
	4.1	16.10	16.35	0.007	0.004
	4.2	15.59	15.81	0.011	0.006

1. Freeboard to exterior top of bank = Exterior top of bank elevation – Maximum water level elevation

4.4.2 Maximum overtopping volume

The maximum overtopping volume of a single wave was calculated based on an exterior top of bank level of 72 ft NAVD88. **Table 4-4** summarizes the results for this analysis based on the East Cell (most conservative scenario), including the percentage of overtopping waves (i.e. the probability that any given wave will overtop the embankment) which is a function of the 2% wave run-up height and calculated based on equations presented in EurOtop (2018).

A maximum overtopping volume of 19.2 ft³/ft for a single wave is estimated for the proposed embankment level. This is below the limit recommended by the EurOtop Manual (i.e. 22 – 32 ft³/ft) for grass covered dikes with maintained and closed grass cover, and hence is deemed acceptable. The maximum overtopping volume, as calculated based on EurOtop (2018), is a function of the number of overtopping waves, which in turn is a function of the storm duration, mean wave period, and percentage of wave that overtop the structure. The values presented in **Table 4-4** are based on a storm duration of approximately 3 hrs (refer to Section 4.3.4), and hence are precautionary with shorter storm durations likely resulting in lower maximum overtopping volumes.

Table 4-4 Summary of overtopping probability and maximum overtopping volume for a single wave (assuming 3 hr storm duration)

Design Case	Freeboard to exterior top of bank (ft)	2% wave run-up (ft)	Probability of overtopping	Maximum overtopping volume for a single wave (ft ³ /ft)
1	14.40	17.1	6.2%	8.2
2	16.75	21.6	9.4%	19.2
3 (Sensitivity Testing)	15.76	26.2	24.2%	60.2
4.1	15.60	17.3	4.1%	6.4
4.2	15.09	17.5	5.4%	7.8

5.0 Findings and Recommendations

To support the preliminary design of the Lake Okeechobee Component A Storage Reservoir (LOCAR) Alternative 1, STWAVE modeling was undertaken to predict wave conditions within the reservoir for the wind and precipitation design cases specified by DCM-2. Modeled design wave heights for the East Cell ranged from 8.1 ft to 10.3 ft, with peak periods ranging from 5.0 to 5.6 s. Modeled design wave heights for the West Cell ranged from 7.6 ft to 9.7 ft, with peak periods ranging from 4.5 to 5.6 s.

Subsequently, an overtopping analysis was undertaken to determine a suitable embankment crest configuration to limit overtopping of the LOCAR to acceptable volumes during wave and wind-setup levels generated from the DCM-2 design cases. A range of analysis techniques, as described in the EurOtop Manual (2018), were used to estimate overtopping characteristics for the proposed 1:3 embankment slope. The results from the analysis indicate that an 18 ft embankment crest width with an exterior top of bank level of 72 ft NAVD88 will achieve acceptable overtopping rates below 0.05 cfs/ft.

Alternative design refinements to manage wave overtopping at the reservoir could also include the following:

- Inclusion of an intermediate berm
- Increasing the roughness of the slope and/or crest by (e.g. quarry stones, concrete blocks) to reduce wave run-up
- Armoring or vegetating the outer (landward side) slope of the embankment to provide increased protection against overtopping.

In addition, after the layout of the reservoir is finalized in subsequent design phases, it is recommended that the spatial variability in the wave overtopping along the embankment is further investigated and the design refined accordingly.

6.0 References

American Society of Civil Engineers. 2022. ASCE/SEI 7-22 Minimum Design Loads and Associated Criteria for Buildings and Other Structures

Ahrens, J.P. 1977 *Prediction of irregular wave overtopping*, CERC CETA 77-7, U.S. Army Engineer Waterways Experiment Station, Vicksburg, MS.

Collective Water Resources. Lake Okeechobee Compartment A Storage Reservoir PMP Determination and PMF Routing, August 8, 2023.

EurOtop. 2018. *Manual on wave overtopping of sea defences and related structures. An overtopping manual largely based on European research, but for worldwide application. Second Edition.* Van der Meer, J.W., Allsop, N.W.H., Bruce, T., De Rouck, J., Kortenhaus, A., Pullen, T., Schüttrumpf, H., Troch, P. and Zanuttigh, B., www.overtopping-manual.com.

Haapala, J., Arnold, T., Shen, Y., Partney, S., Tucker, R., Hadley, L., and Smith, S. 2006. *Design Criteria Memorandum: DCM-2, Wind and Precipitation*, February 2006.

Hughes, S. 2017. *Wave Overtopping and Wave Loading Analysis for the C-43 Reservoir*, prepared for Carollo Engineers Inc, Version 3.0, 6 March 2017.

J-Tech (2023). *Lake Okeechobee Component A Storage Reservoir Feasibility Study – Assessment of Allowable Wave Overtopping. Technical Memorandum.* January 2024

J-Tech (2018). *Post-Authorization Change Report – Appendix A Annex A-2: A-2 Reservoir Wave and Overtopping Analysis. Technical Memorandum.*

Shore Protection Manual (SPM). 1984. 4th ed., 2 Vols., US Army Engineer Waterways Experiment Station, Coastal Engineering Research Center, US Government Printing Office, Washington, DC, Chapter 3, pp. 24-66.

Smith, J.M. 1991. *Wind-Wave Generation on Restricted Fetches*, Miscellaneous Paper CERC-91-2, US Army Engineer Waterways Experiment Station, Vicksburg, MS.

Smith, J M., Sherlock, A R., Resio, D T. 2001. *STWAVE: Steady-state spectral wave model user's manual for STWAVE, Version 3.0*, ERDC/CHL SR-01-1, U.S. Army Engineer Research and Development Center, Vicksburg, MS.

U.S. Army Corps of Engineers (USACE). 1997. *Hydrologic Engineering Requirements for Reservoirs*, EM-1110-2-1420.

Van Doorslaer, K., De Rouck, J., and Van der Meer, J. W. 2016. *The reduction of wave overtopping by means of a storm wall*, Proceeding of the 35th Coastal Engineering Conference, American Society of Civil Engineers.

Vincent, C. L. 1984. *Deepwater Wind Wave Growth with Fetch and Duration*, Miscellaneous Paper CERC-84-13, US Army Engineer Waterways Experiment Station, Vicksburg, MS.

Weggel, J.R. 1976. *Wave overtopping equation*, Proceedings of the 15th International Coastal Engineering Conference, American Society of Civil Engineers, Vol 3, pp 2737-2755.

Prepared for:	South Florida Water Management District
Prepared by:	J-Tech, an Alliance between Jacobs Engineering and Tetra Tech, Inc.
Date:	January 2024
Subject:	Lake Okeechobee Component A Storage Reservoir Feasibility Study Wave Overtopping Analysis (Alternate Approach)

1.0 Background/Introduction

The South Florida Water Management District (SFWMD), as the non-Federal sponsor for the Comprehensive Everglades Restoration Plan (CERP), is conducting a Feasibility Study for the Lake Okeechobee Component A Storage Reservoir (LOCAR) Section 203 Study under the federal Water Resources Development Act (WRDA) of 1986, as amended.

The purpose of the LOCAR reservoir is to store excess water in the northern watersheds and release it at times when it is beneficial for the region. This increased storage capacity will reduce the duration and frequency of both high and low water levels in Lake Okeechobee, which can harm Lake Okeechobee's ecology. With these improvements to Lake Okeechobee levels, the reservoir will help reduce the likelihood of harmful discharges from Lake Okeechobee to the northern estuaries.

This memorandum summarizes the computational fluid dynamics (CFD) modeling of wind, waves, and overtopping performed by J-Tech for the LOCAR Recommended Plan (presented in the LOCAR Section 203 Feasibility Study Report, dated October 2023), referred to in this memorandum as Alternative 1.

1.1 Reservoir Description

1.1.1 General Layout

The LOCAR Alternative 1 site is located in Highlands County, Florida. It is situated approximately 15 miles northwest of Lake Okeechobee (**Figure 1-1**). The reservoir covers about 6 miles (east to west) by 4 miles (north to south), and is sited on the Bassinger Tract as shown in **Figure 1-2**. An East and West Cell are proposed for the reservoir, separated by a divider dam intended to reduce the maximum fetch across the reservoir and, therefore, reduce wave heights during extreme storm events.

Early development of Alternative 1 included an approximately 12,500-acre reservoir site with a Normal Full Storage Level (NFSL) of 50.6 NAVD88 with a total storage capacity of 200,000 acre-feet. The layout of the initially proposed reservoir is shown in **Figure 1-2(a)**. A recently identified, ecologically sensitive area, within the footprint of the original proposal required modifications to the footprint on the same tract. Omission of this area (approximately 474 acres) from the reservoir footprint results in a slightly smaller areal footprint with a corresponding increase in the NFSL, from 50.6 to 51.7 feet NAVD88, to maintain the required reservoir capacity at 200,000 acre-feet.

Figure 2-1(b) presents the revised proposed layout omitting the Ecologically Sensitive Area. The initial analysis in the draft version of this Technical Memorandum (TM) was performed based on the layout shown in **Figure 2-1(a)**. This analysis was updated in this TM to capture the change in the NFSL associated with the layout shown in **Figure 2-1 (b)**. To expedite the study, it should be noted, however,

that certain features of the analysis were still based on the previous reservoir configuration as they were considered to have minimal impacts on the assumptions used for the feasibility level of analysis.

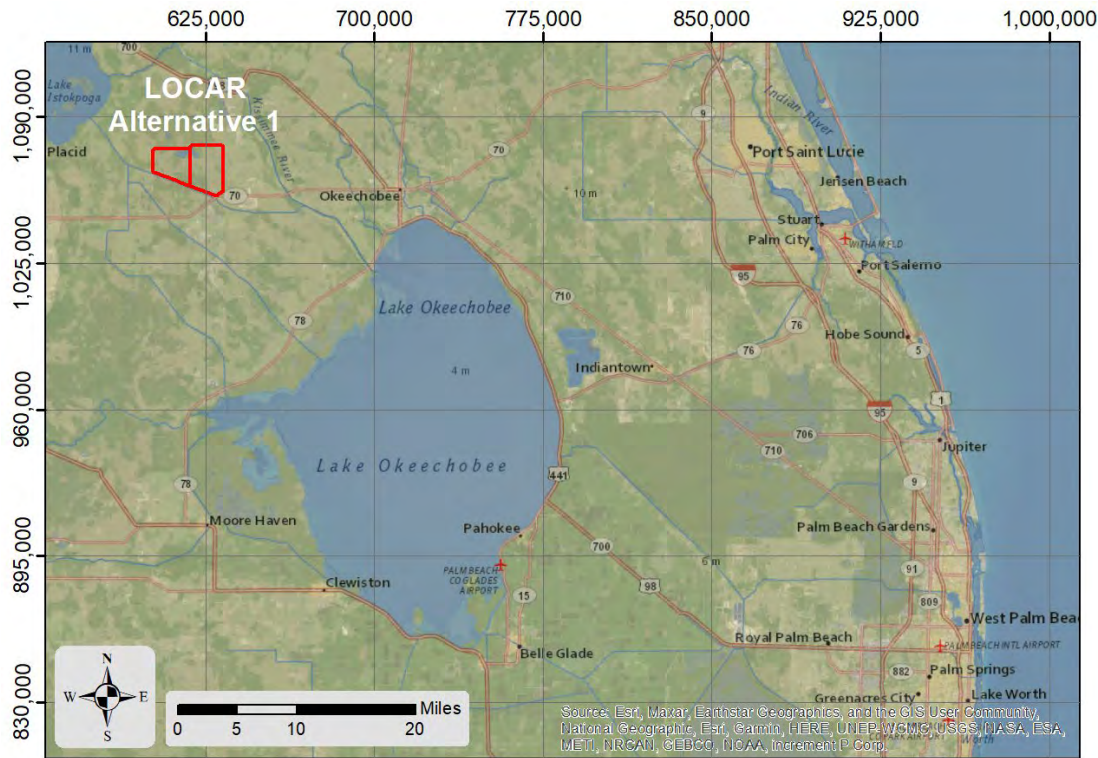
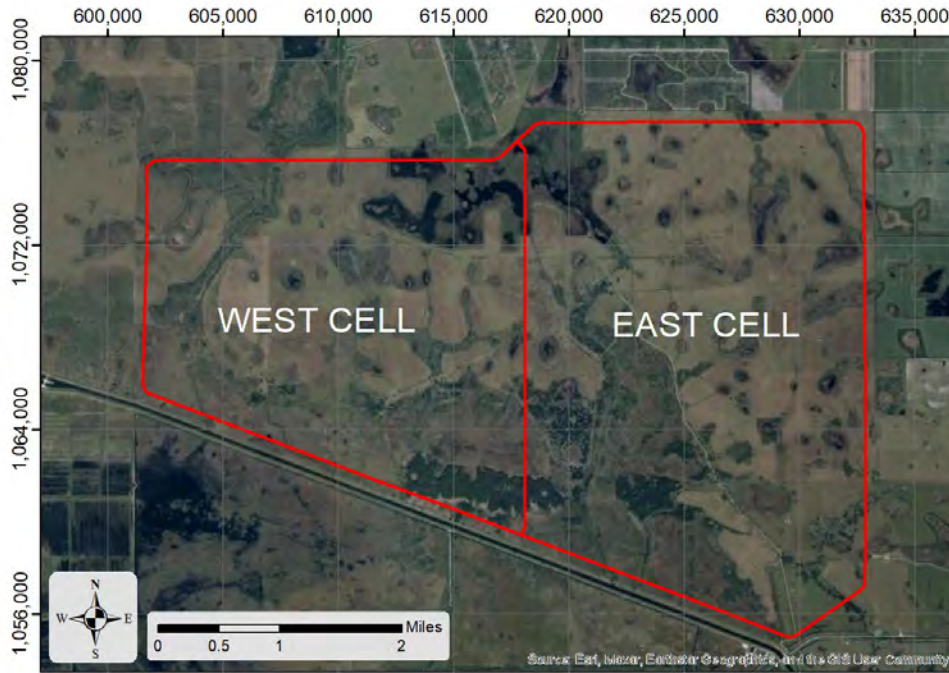


Figure 1-1 Location of LOCAR Alternative 1

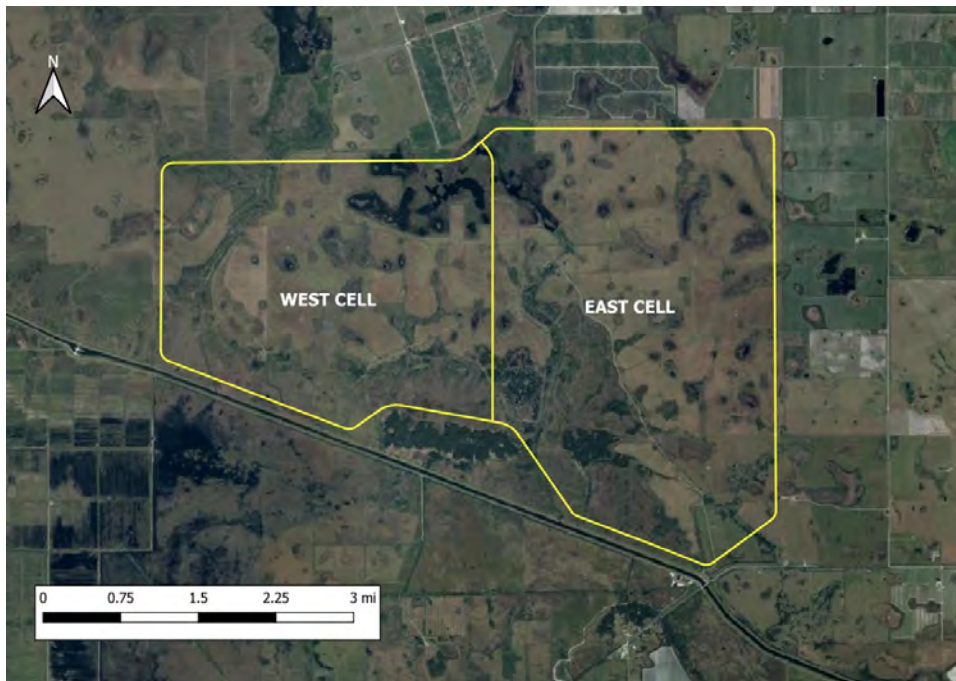
1.1.2 Embankment Characteristics

Figure 1-3 illustrates the cross-sectional design of the LOCAR embankment used for the overtopping analysis. A slope of 1V to 3H is proposed for the inner and outer slopes of the embankment, with 12-inch-thick soil cement liner on the inner slope and 6 inches of topsoil on the outer slope. In addition, a wave wall is proposed on the landward side of the embankment crest to reduce the overtopping of the embankment to appropriate levels. The suitability of the proposed wave wall configuration to meet acceptable overtopping limits has been investigated as part of this assessment. The wave wall will have gaps every 500 feet for wildlife passage, the openings of which will be protected by upstream wave walls serving to limit wave overtopping up past the opening.

The reservoir's NFSL is at an elevation of 51.7 ft NAVD88. A 3 foot deep by 500 foot wide borrow area is located inside the perimeter of the East and West Cells approximately 300 feet from the inside toe of the embankment. The cross-sectional design of the divider dam, which separates the East and West Cells, is shown in **Figure 1-4**.



(a) Initial footprint



(b) Final footprint

Figure 1-2 Layout of LOCAR Alternative 1

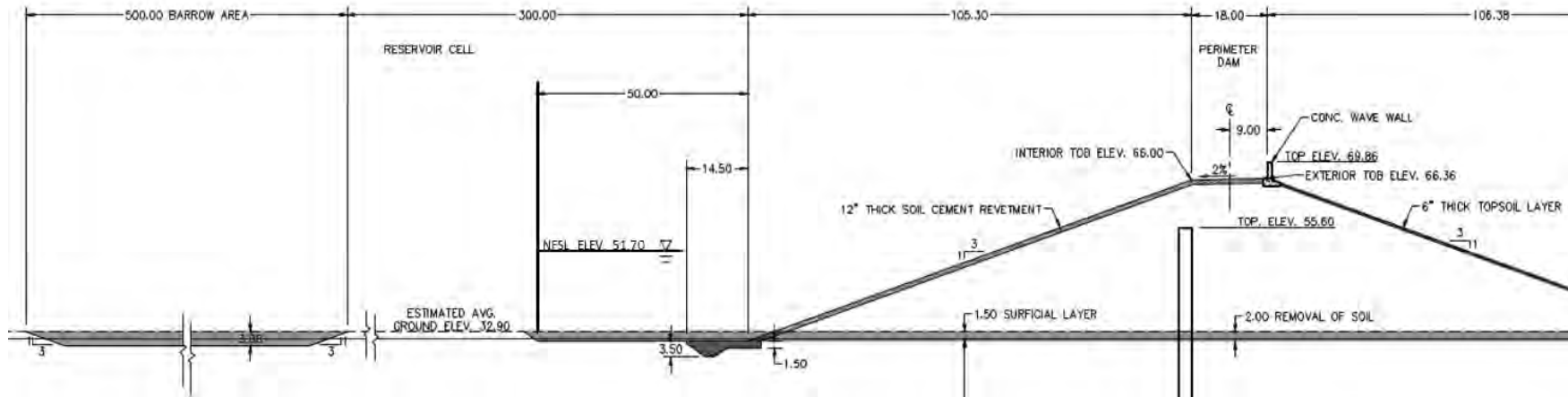


Figure 1-3 Typical cross section for the LOCAR embankment

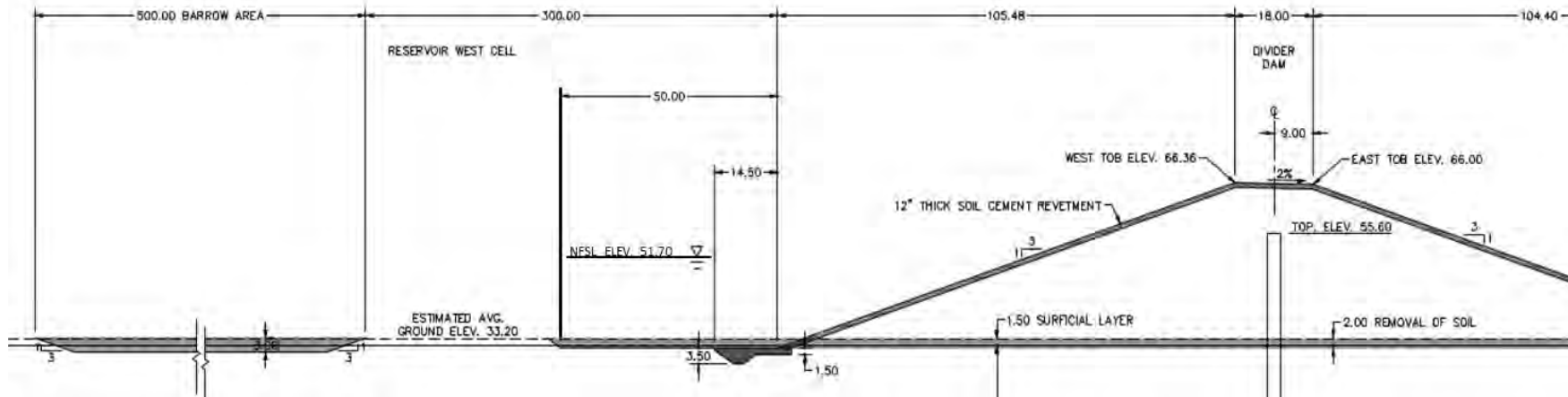


Figure 1-4 Typical cross section for the divider dam

1.2 Objective

The objective of this TM is to evaluate the ability of the LOCAR reservoir to limit average overtopping to less than 0.005 cubic feet per second per foot of embankment (cfs/ft). This discharge limit was established based on previous overtopping studies conducted by the District during the Acceler8 Program. That study indicated for sand embankments, like that proposed for LOCAR be limited to 0.005 cfs/ft of crest to minimize potential for overtopping failure.

A parallel overtopping analysis has been performed that utilizes wave modeling based on traditional methods of adjusting wind speeds for use in modeling wave growth and empirical relationships for estimating overtopping. This parallel effort is documented in J-Tech (2023a). The analysis reported in this TM utilizes CFD modeling to better define the wind characteristics for wave growth modeling throughout the reservoir and better characterize overtopping for the preliminary reservoir embankment geometry. Additionally, adjustments to the wave model's drag coefficient, which impacts the momentum transfer between the wind and the waves, are made consistent with recent research into surface drag during extreme wind events.

Subsequently, the CFD model developed for wave overtopping will be utilized to provide detailed wave loading information for the structural design of the wave wall at the top of the embankment as the project progresses in final design.

1.3 Approach

This TM is divided into six sections:

1. Background/Introduction describes the project site, objectives, and the TM organization
2. Design Storm Events documents the design cases used to establish freeboard requirements based on previously developed Design Criteria Memorandums (DCMs)
3. Wind Field Definition documents modeling performed to define the wind field as it transitions across the reservoir
4. Wind Setup and Wave Setup Modeling documents the analysis used for modeling wind setup and wind wave conditions for each of the modeling scenarios
5. Overtopping Analysis documents the approach to estimating overtopping for the different design cases based on a CFD approach
6. Summary of Results presents results compared with results from the parallel analysis and presents conclusions and recommendations

The largest waves and most extreme conditions for overtopping will occur in the East Cell of the LOCAR reservoir which has the longest fetch and, therefore, for the purposes of Preliminary Design this TM only addresses waves generated in the East Cell of the LOCAR.

A draft version of this TM was previously limited to modeling of a single design case due to time limits on the modeling effort. The analysis has been expanded to modeling all four design cases considered for the reservoir.

2.0 Design Storm Events

Four combinations of extreme winds and precipitation, as described in DCM-2 (Haapala et al., 2006), were used to provide a preliminary assessment of the design wave conditions for the design of the reservoir embankments,

and the evaluation of the associated wave overtopping volumes. Details regarding these conditions are summarized below.

2.1 Design Case 1: PMP combined with 100-year wind

Design Case 1, as documented in the routing analysis included in J-Tech (2023b), assumes an event that includes a series of three major storm events, including a storm with the Probable Maximum Precipitation (PMP) and a 100-year Average Recurrence Interval (ARI) wind acting on the reservoir during the peak water level in the reservoirs. The maximum still water elevation was determined based on a routing analysis that assumed:

- Routing starts when the reservoir is at the Normal Full Storage Level (NFSL) of 51.7 feet NAVD88.
- The maximum discharge from the 17.8 square mile reservoir into the C-41A Canal is 1500 cubic feet per second (cfs).
- 30 percent of the 72-hour PMP (16.2 inches) falls during the first storm in the first 72 hours. Gated structures are closed.
- A 3-day dry interval occurs. Gated structures open and discharge at a combined rate of 1500 cfs.
- 100 percent of the 72-hour PMP (54 inches) falls during the second storm. Gated structures are closed.
- A 10-day dry interval occurs. Gated structures open and discharge at a combined rate of 1500 cfs.
- 30 percent of the 72-hour PMP (16.2 inches) falls during the third storm. Gated structures are closed.

The procedure described in DCM-2 (Haapala et al., 2006) was followed to estimate the 100-year ARI wind speed magnitude for the LOCAR. As specified in DCM-2, the 50-year three-second wind gust for the LOCAR site is 112 mph, which converts to approximately 120 mph for a 100-year three-second wind gust. This matches the latest ASCE 7-22 100-year wind gust estimates for the region.

The 100-year gust wind speed was converted to a 100-year one-hour overland wind speed of approximately 79.4 mph representing an averaging period appropriate for wave modeling described in **Section 4**.

2.2 Design Case 2: 100-Year Precipitation combined with category 5 hurricane winds

Design Case 2 represents a 100-year precipitation event in combination with a Category 5 wind speed as defined by the Saffir-Simpson Hurricane Scale.

A 100-year precipitation event of 12 inches has been adopted for this design case which is based on Figure DCM 2-3 (Haapala et al., 2006). This is slightly higher than the NOAA Atlas 14 rainfall estimate of 10.9 inches for the site location.

As recommended in DCM-2, a one-minute overwater wind speed of 156 mph was used to represent a Category 5 hurricane. After adjustments for duration to achieve fully developed wave conditions over the reservoir cell fetch lengths, the sustained wind speed magnitude was estimated to be 125.1 mph.

2.3 Design Case 3: Probable maximum wind speed

Design Case 3 represents the Probable Maximum Wind (PMW) speed in combination with the reservoir level at the normal full storage depth (i.e. approximately 17.6 ft for the LOCAR). As recommended in DCM-2, this

particular design case was used for sensitivity testing only and not as a selected design condition (Haapala et al., 2006):

[The probable maximum wind...] is to be used for “sensitivity identification” and not as a design condition. Wave models are unlikely capable of yielding results within a degree of confidence for design for these extreme wind speeds, especially over relatively shallow water bodies. Even for 125-mph wind, model capabilities are most likely being “stretched” for project conditions.

As defined in DCM-2, a one-minute averaged overwater wind speed of 200 mph was used to represent the PMW. After adjustments for duration, the sustained wind speed magnitude was estimated to be 161.3 mph.

2.4 Design Case 4: Storm specific wind and precipitation

Design Case 4 represents a storm specific case of precipitation and wind conditions recorded during Hurricane Easy which occurred in Florida in 1950.

Precipitation depths for both the 24-hour and 72-hour rainfall durations are considered in this analysis, corresponding to 38.7 inches and 45.2 inches respectively (Haapala et al., 2006).

A maximum wind speed of 125 mph (3 second gust) was recorded during Hurricane Easy (Haapala et al., 2006). After adjustments for wind duration for wave development the sustained overland wind speed magnitude was estimated to be 82.8 mph.

2.5 Summary

Table 2-1 summarizes the wind and precipitation design conditions for the East Cell. It is noted that the wind speeds for Design Cases 2 and 3 are specified in DCM-2 as overwater wind speeds. Design Cases 1, 4a, and 4b represent overland wind speeds. Adjustment of Design Cases 1, 4a, and 4b to overwater values is addressed in **Section 3** below. Design Case 3 is included for sensitivity purposes only. Input and results for Design Case 3 are based on the initial reservoir geometry shown in **Figure 1-2(a)**.

Table 2-1 Design Cases for LOCAR Freeboard Analysis.

Design Case	Description	Wind Speed (mph)	Precipitation (inches)	Stillwater Elevation (ft, NAVD88)
1	100 yr wind + PMP/PMF Event	79.4 ¹	97.2 ³	56.3
2	Category 5 Hurricane + 100 year Precipitation	125.1 ²	12	52.7
3	Probable Maximum Wind Speed	161.3 ²	0	50.6 ⁴
4 (24 hr)	Storm Specific Wind & Precipitation	82.8 ¹	38.7	54.9
4 (72 hr)	Storm Specific Wind & Precipitation	82.8 ¹	45.2	55.5

¹ Represents an overland wind speed.

² Represents an overwater wind speed based on guidance from DCM-2.

³ The probable maximum precipitation equals 54.0 inches. The precipitation for Design Case 1 is based on the occurrence of three consecutive storms, with the first and third, each bringing 30% of the PMP and the second bringing the full PMP.

⁴ Based on the initial reservoir geometry shown in **Figure 1-2(a)**.

3.0 Wind Field Definition

Wind speed adjustments are required for wave growth modeling to adjust for differences in winds based on measured data to values required by the wave growth model. These are typically necessary for:

- Elevation, if the measured or specified winds are taken at an elevation other than a standard 10-meter (33-foot) height above the ground,
- Averaging time of the wind measurement to adjust to a time span that is required to fully develop wave conditions in the reservoir, and
- Differences in overland and overwater wind speeds, if measured or specified winds, are based on overland winds.

Wind speeds developed for Design Cases 1, 4a, and 4b in **Table 2-1** are based on standard 10-meter (33-foot) elevations; no adjustment was necessary for elevation. Overland winds were adjusted to averaging times consistent with time to fully develop waves within the reservoir using procedures presented in the Coastal Engineering Manual (USACE, 2008) based on the design windspeed and maximum fetch of the reservoir.

Windspeeds will transition as they move from land to water due to differences in roughness between the terrain and that of the water surface. Wind will tend to increase in speed for speeds less than about 33 mph and decrease for higher winds in response to the increasing surface roughness from wave growth. This transition occurs over the first 10 miles or so of fetch. For winds over 41.5 mph and distances over 10 miles, USACE (2008) guidance specifies using an overwater wind speed that is 10 percent less than the overland wind. For distances less than about 10 miles, wave growth is associated with a transitional atmospheric boundary layer which has not fully adjusted to the overwater regime and USACE (2008) suggest using a factor of 1.2 to adjust the wind, regardless of wind speed. The LOCAR reservoir, with a maximum fetch of approximately 4.7 miles, lies within this transitional zone.

For the LOCAR reservoir, the transition from overland to overwater also includes a change in elevation as the wind flows from the terrain at ground level over the embankment and to the water at an elevated level within the atmospheric boundary layer and there is likely also a transition zone as the boundary layer adjusts to this higher ground elevation that is not accounted for in simplified wind adjustment methods. It is unclear how well traditional methods of windspeed adjustment represent these conditions. For the analysis for Design Cases 1, 4a, and 4b, rather than applying a 1.2 factor to represent the transition from overland to overwater within these transition zones, the wind field was modeled using Computational Fluid Dynamics (CFD) to model the transition as the wind flows over the banks and across the reservoir.

3.1 Wind Modeling Approach

An Atmospheric Boundary Layer (ABL) model was used to model the wind as it flows from overland over the embankment and across the reservoir surface. The ABL model is a three-dimensional (3D) steady-state model that models the air as an incompressible fluid using the SimpleFoam solver from OpenFOAM. Governing equations for the SimpleFoam solver are listed in the OpenFOAM website (OpenFOAM, 2023).

A kEpsilon ($k - \epsilon$) turbulence model was used, following guidance from Hargreaves, D.M., et. al. (2007), with a value of k of 0.4 and σ_ϵ value of 1.11.

A wind map was generated by converting the resulting shear stress of the wind on the water surface into equivalent 10-meter winds across the reservoir surface for use in the wave generation model.

3.2 Model Inputs and Assumptions

Input to the ABL model includes:

- Definition of the model geometry
- Definition of shear stress at the top boundary
- Definition of surface roughness for the bottom boundary (for land, embankment and water areas)
- Specification of the wind profile at the inlet boundary

Figure 3-1 shows a plan view of the model geometry based on the initial reservoir geometry shown in **Figure 1-2(a)**. The reservoir embankment is shown in yellow and the model mesh in blue. The mesh also covers the area within the reservoir but has been removed in **Figure 3-1** to more easily see the embankment. The mesh cell sizes inside the reservoir are similar to those outside.

It is assumed that the wind during the design event can occur from any direction, and, for the purpose of this analysis, it was assumed that the critical wind direction was from 330 degrees True North, approximately aligned with the direction of maximum fetch in the East Cell of the reservoir. The reservoir was rotated in the model as shown in **Figure 3-1** so the wind coming from the x-direction is at the correct alignment relative to the reservoir.

As suggested in Hargreaves, D.M., et. al. (2007), a constant shear stress, τ , was applied at the top boundary calculated as:

$$\tau = \rho_{air} U^*$$

$$U^* = \frac{U_{ref} k}{\ln\left(\frac{Z_{ref} + z_0}{z_0}\right)}$$

with:

ρ_{air} = air density

U^* = friction velocity

U_{ref} = wind velocity at height the reference height

k = von Kármán's constant of 0.4

Z_{ref} = reference height, in this case of 10m (hence $U_{ref} = U_{10}$)

z_0 = roughness height of the surface.

From analysis of the area around the reservoir, the ground is very flat, with agricultural fields with some sparse vegetation, particularly along the roads and streams. Following Burton, T, et al. (2011), the roughness height (z_0) of the ground around the reservoir was defined as 0.03m, which is the value suggested for fallow fields. For the embankment, the roughness height was defined a z_0 of 0.01m.

The shear stress between the air and water surface, which transfers momentum from the wind field into waves in the reservoir, is calculated as $\tau = C_D U^2$, in which C_D is the coefficient of drag. The coefficient of drag was set to 0.0026, based on findings of Curcic and Haus (2020) and a review of proposed drag coefficient correlations in Bryant and Akbar (2016) and is consistent with the value used in the wave modeling described in **Section 4**. The corresponding water roughness height, z_0 , for the selected C_D was calculated using Equation (II-2-7) from USACE (2008) and the equation for friction velocity, U^* , from the OpenFOAM documentation, as:

$$z_0 = \frac{10}{\exp\left(\frac{k}{\sqrt{C_D}}\right) - 1}$$

Other model parameters were defined as described in Hargreaves, D.M., et. a. (2007).

The model sensitivity to model cell size was evaluated for the cell dimensions in the horizontal (x and y) directions. The final horizontal dimensions of the cells throughout the model were set to 27 meters (88.6 feet) in both the x and y directions. Finer meshes with 20- and 25-meter (65.6- and 82.0-foot) cell sizes resulted in no significant difference in model results.

The approach described in Hargreaves, D.M., et. a. (2007) was used for defining the model mesh in the vertical (z) dimension, with 50 cells distributed along a total height of 500 meters (1640 feet), with the cells at the ground level set at 1 meter (3.3 feet) thick, with the thickness increasing with elevation to 40 meters (131 feet) at the top of the model.

The overland wind speed profile was set along the inlet boundary. The lateral boundaries are no-flow boundaries with wind leaving the model through the right-hand boundary. The resulting shear stress at the air/water boundary over the surface of the reservoir was output allowing a map of the resulting 10-meter (33-foot) wind speed to be generated - calculated based on a drag coefficient, C_D , of 0.0026.

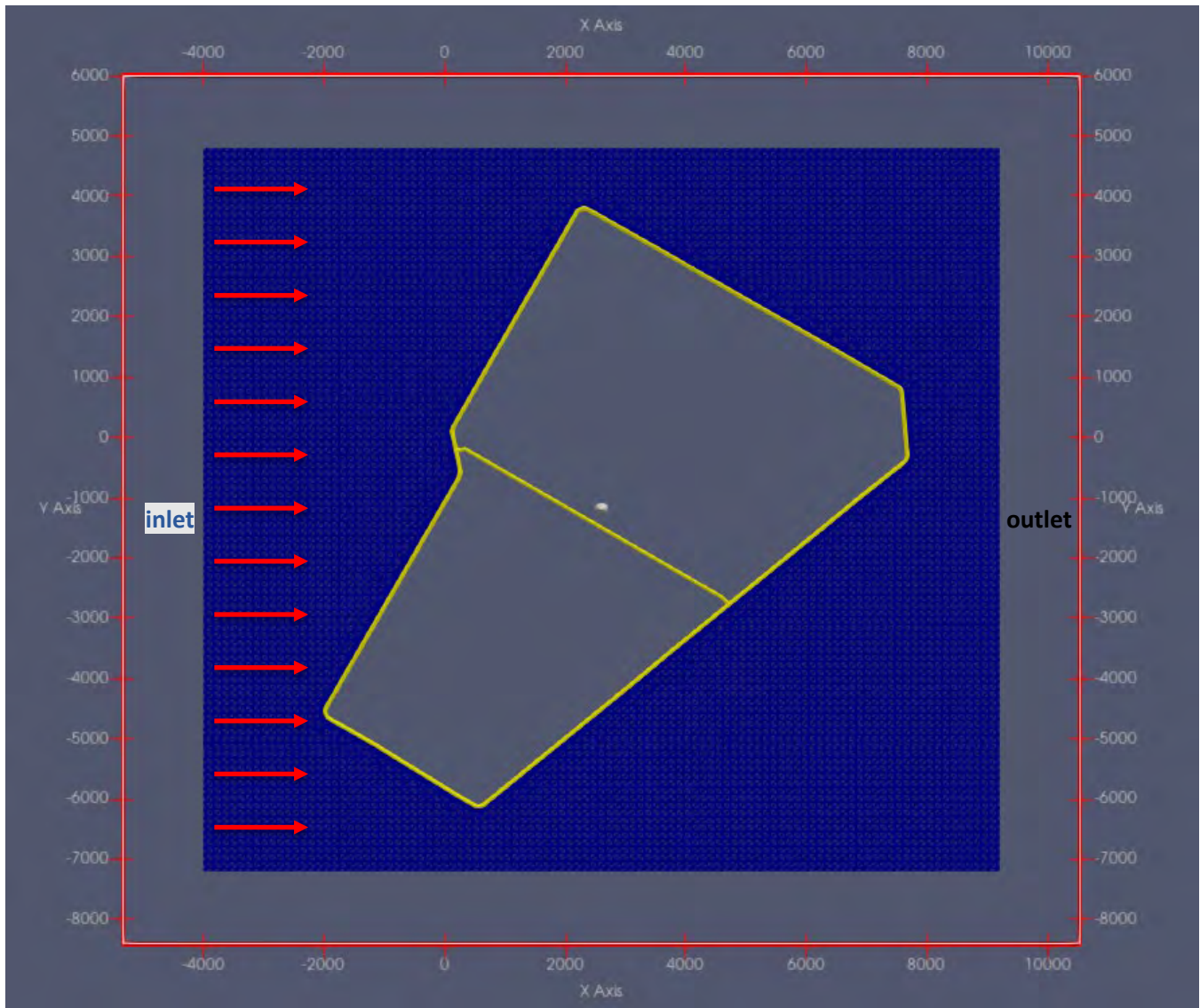


Figure 3-1 Overall model mesh

3.3 Model Results

The resulting wind maps for Design Cases 1 and 4(a and b) using the initial reservoir geometry shown in **Figure 1-2(a)** are reproduced as **Figure 3-2 and 3-3**. Because the portion of the reservoir that was omitted for the final layout was distant from the maximum fetch line and would, therefore, have no significant effect on the wind-induced wave growth through the reservoir, the wind model was not re-run with the final (adjusted) reservoir footprint and wind maps shown in **Figures 3-2 and 3-3** were used for wind wave and storm surge modeling described in **Section 4**.

The maps show some sheltering of the wind along the northern and western edge of the reservoir and wind building as it transitions from land through the water of the perched reservoir. The strongest winds flow through

the centers of the reservoir cells starting near their northwest corners as a result of the winds refracting as they flow over the embankments of the reservoir cells.

Wind speeds in the East Cell for Design Case 1 show an increase of about 3 percent near the northern edge of the reservoir (82 mph compared with an overland wind of 79.4 mph) increasing to about a 12 percent increase at the southeast corner of the reservoir where the wind speed increases to about 89 mph and an average windspeed over the cell of 87.8 mph (a 10.6 percent increase compared with the overland windspeed). Cases 4a and 4b show similar characteristics with the lowest winds along the upstream embankments and the maximum winds focused down the center of the reservoir. It is noted that the sharper corner on the northwest end of the West Cell focuses winds more, with higher peak values, than focused wind the East Cell. Although peak winds are larger in the West Cell, larger waves should be expected in the East Cell due to a longer fetch and higher overall average windspeeds.

A summary of results of winds for the East Cell is presented in **Table 3-1**. Both cases show similar characteristics with increases over the overland wind speed varying from less than 3 percent near the northern embankment to 12 percent at the southeast corner and 10 to 11 percent on average.

These wind maps were used as input to the hydrodynamic and wave growth models discussed in **Section 4**.

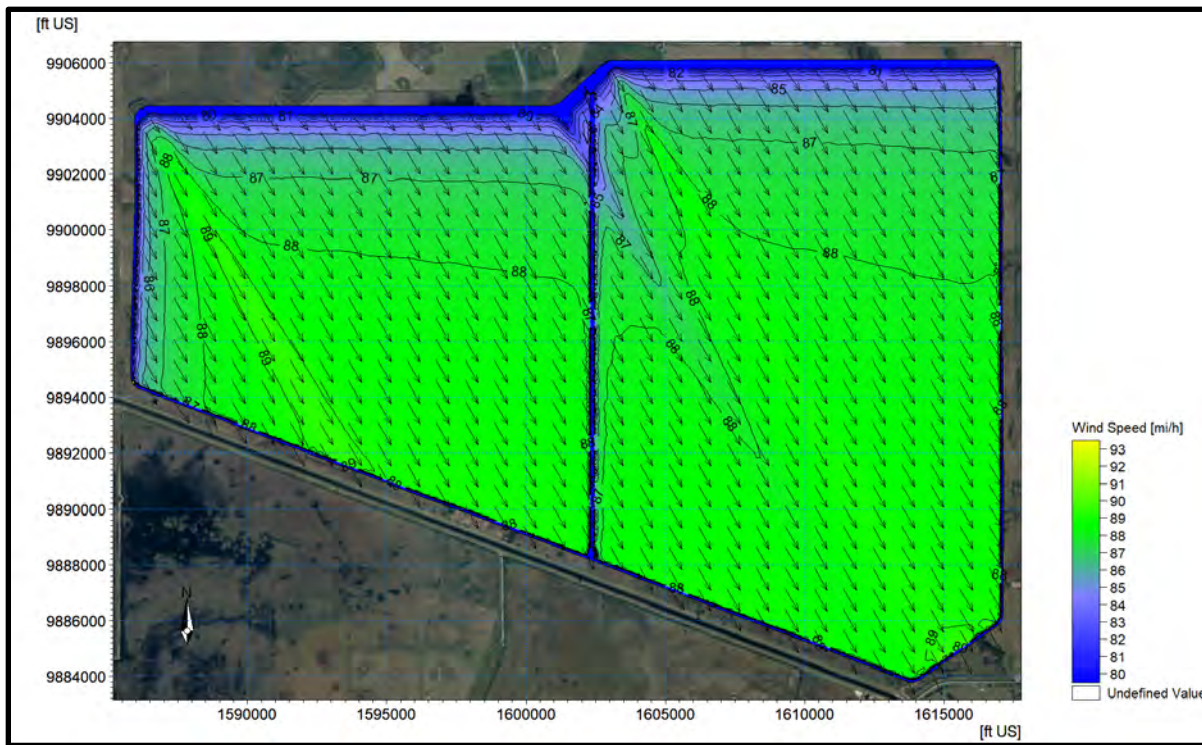


Figure 3-2. Wind Map for Design Case 1.

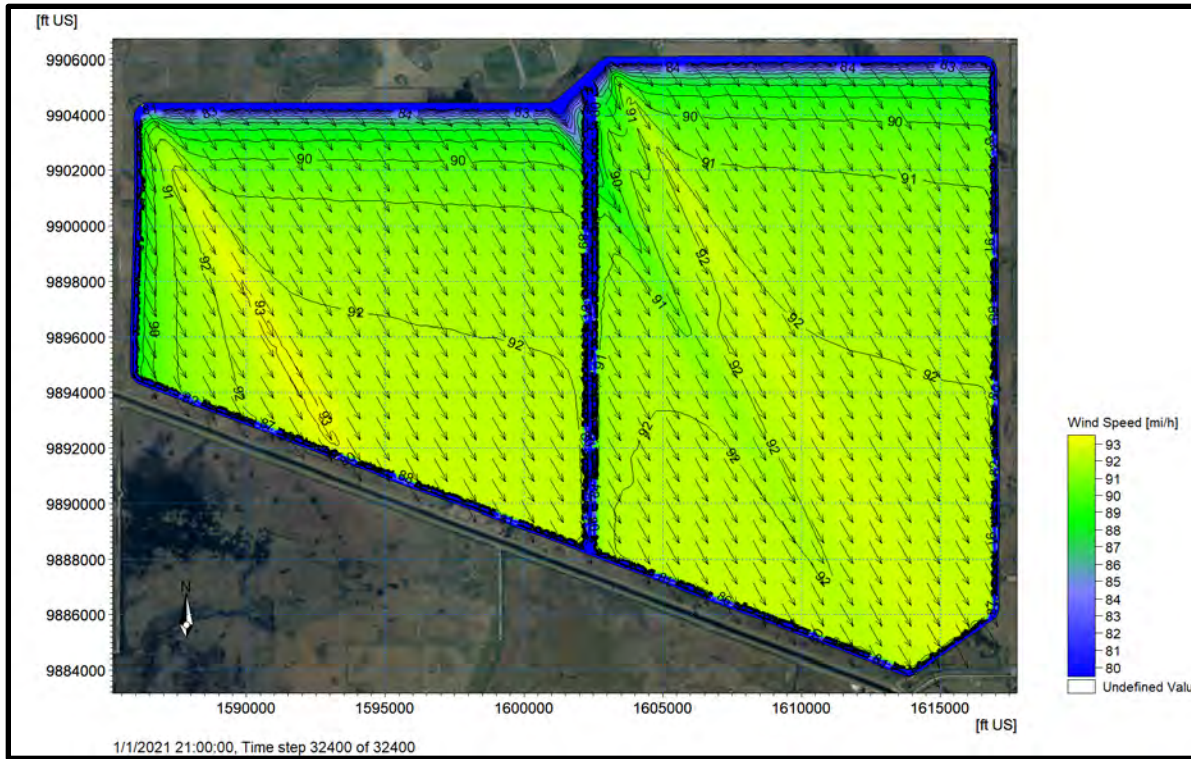


Figure 3-3. Wind Map for Design Cases 4a and 4b.

Table 3-1. Summary of Wind Modeling Results, East Cell

Design Case	Overland Wind Speed (mph)	Over Water Wind Speed (mph)			Change from Overland Windspeed		
		Minimum	Maximum	Average	Minimum	Maximum	Average
1	79.4	82	89	87.8	3%	12%	11%
4a and 4b	82.8	84	92.5	91.4	1%	12%	10%

mph = miles per hour

4.0 Wind Setup and Wave Modeling

The DHI model, MIKE21 was used to model wind setup and wave growth through the reservoir using the hydrodynamic (HD) and spectral wave (SW) modules. MIKE21 is a 2-dimensional (2D) modeling system that can simulate wind setup due to the wind acting on the water surface, as well as growth, decay and transformation of wind generated waves.

4.1 Modeling Approach

The following subsections describe the numerical modeling approach used to define design wave conditions for the East Cell of the LOCAR Reservoir. It included the following steps:

- Definition of the model domain
- Definition of model input
- Evaluation of results

4.2 Model Domain

The model domain defines the extent and boundaries of the project site and discretizes the water area, bathymetry, and boundaries with a variable size mesh. For the LOCAR reservoir, the model boundaries were defined by the geometry of the ring dike (horizontal boundaries), the topography and bathymetry of the reservoir bed (vertical boundaries) and the water level (free surface boundary).

Lateral boundaries are based on the digital model of the embankment for the preliminary design. The bathymetry was defined based on LIDAR data of the existing topography, modified to include features shown in the preliminary design. The initial free surface boundary for each design case was set at a constant water level equal to the stillwater levels shown in **Table 2-1**.

Figure 4-1 shows the footprint of the initial reservoir geometry and the model bathymetry in terms of the water depth in feet below NFSL. This was subsequently modified to reflect the changes made to the reservoir footprint shown in **Figure 1-2(b)**.

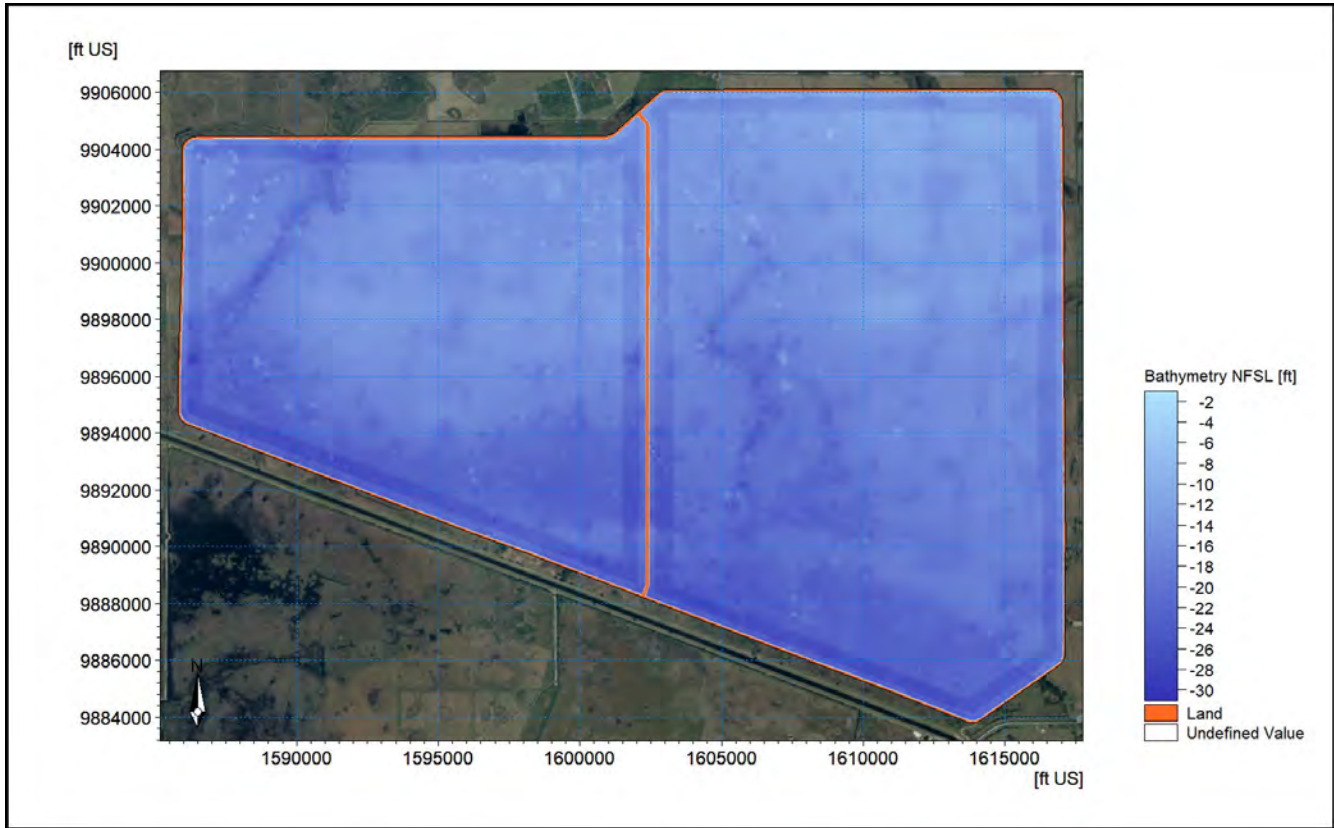


Figure 4-1. Model Bathymetry.

A model mesh was generated for the bathymetry shown in **Figure 4-1** with modifications shown in **Figure 1-2(b)**. MIKE21 HD and SW utilize an unstructured computational mesh that is capable of higher resolution in some areas where needed. An example model mesh for the initial geometry is shown in **Figure 4-2**. The mesh shown in **Figure 4-2** (and modified to reflect changes shown in **Figure 1-2(b)**) includes triangular elements that are about 170 feet on a side in the central portion of the reservoir and 30 feet on a side closer to the periphery, and rectangular elements around the periphery that are about 20 feet by 30 feet on a side.

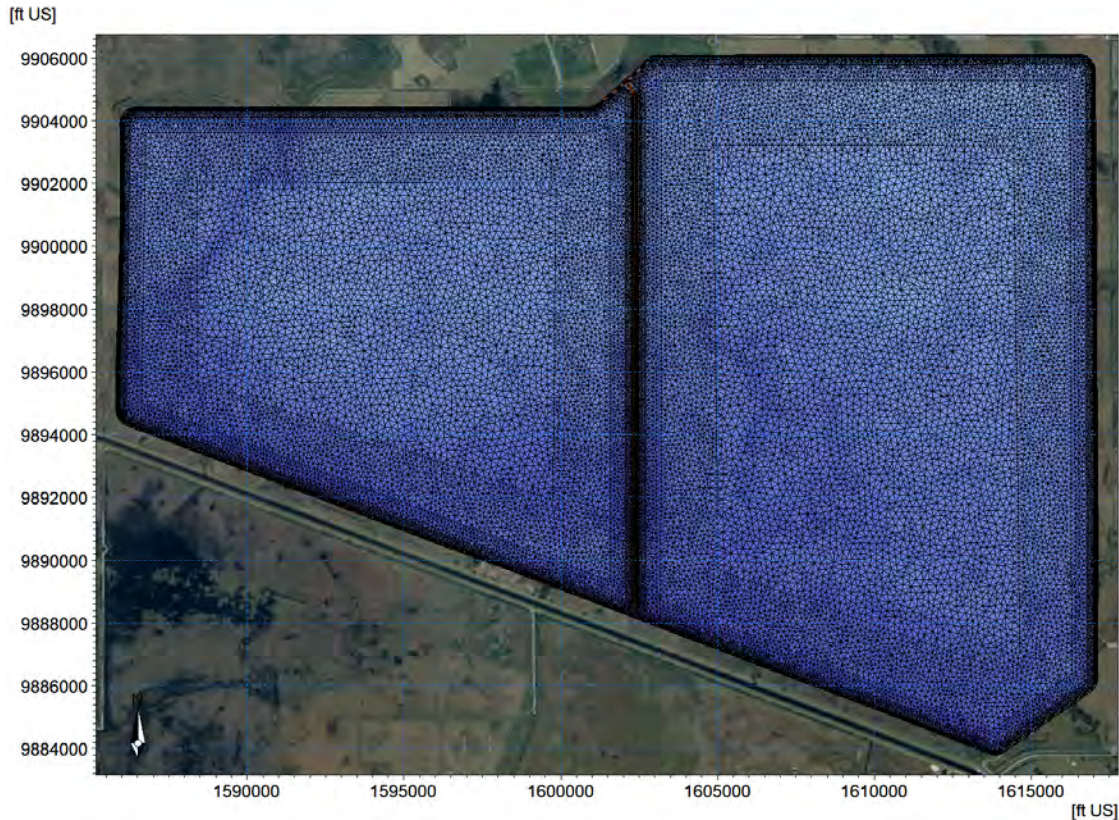


Figure 4-2. Model Mesh.

4.3 Model Input

Input to the model included:

- Wind definition
- Definition of model bathymetry
- Specification of the bottom roughness, based on a default Nikuradse roughness, k_s , of 0.04 meters.
- Specification of the drag coefficient at the air/water interface

Of these, the spectral wave model is most sensitive to the wind input and the drag coefficient at the air/water interface; both of which influence the transfer of energy from the wind to the waves. The definition of the wind field and model bathymetry are described in **Sections 3 and 4.2**, respectively.

The drag coefficient at the wind/water surface, C_d , is a function of the wind speed. Data suggests that the drag coefficient increases linearly at lower wind speeds, below about 55 mph, but reaches a point of saturation at which point the drag coefficient stops increasing with some evidence that it may even decrease significantly at higher wind speeds (Bryant and Akbar, 2016). Laboratory studies performed by Curcic and Haus (2020) suggest that the drag coefficient saturates at a level of approximately 0.0026. Based on proposed drag coefficient correlations in Bryant and Akbar (2016), this level appears to be a conservative representation for C_d . For the purposes of this study, a cap of 0.0026 was placed on the drag coefficient in MIKE21. Based on proposed

correlations in Bryant and Akbar (2016), this should be considered a conservative estimate for the purposes of preliminary design, particularly at wind speeds higher than about 70 mph, when C_d starts to decrease with higher windspeeds, and use of a lower value may be considered for final design.

The same model mesh was used for modeling wind setup using MIKE21 HD and wave generation using MIKE21 SW.

4.4 Results

Wave model results for Design Cases 1 through 4(a and b) are illustrated in **Figure 4-3 through 4-6**, respectively. **Figures 4-7 through 4-10** similarly present results for wind setup from the hydrodynamic model. It is noted that the results presented in **Figures 4-3 through 4-10** are based on the initial model geometry. Results presented in this section are based on the modified geometry shown in **Figure 1-2(b)**. Adjustments in the model geometry had no significant impact on the waves and wind setup at the southeast corner of the reservoir.

Results are summarized in **Table 4-2**. Wave modeling results are given in terms of significant wave height, H_s , and the peak wave period, T_p . The significant wave height and peak periods are measures of the characteristics of a wave spectrum for irregular waves. The significant wave height is equal to the average of the highest one-third of the waves in the spectrum, with the maximum waves in the series (if not limited by water depth) as high as two times the significant wave height.

Table 4-1. Summary of Results – Peak Waves and Wind Setup.

Design Case	H_s (feet)	T_p (seconds)	Wind Setup (feet)
1	8.2	4.8	0.9
2	10.5	5.2	2.0
3	12.1	5.3	3.4
4a	8.4	4.8	1.1
4b	8.5	4.8	1.1
H_s = significant wave height T_p = peak wave period			

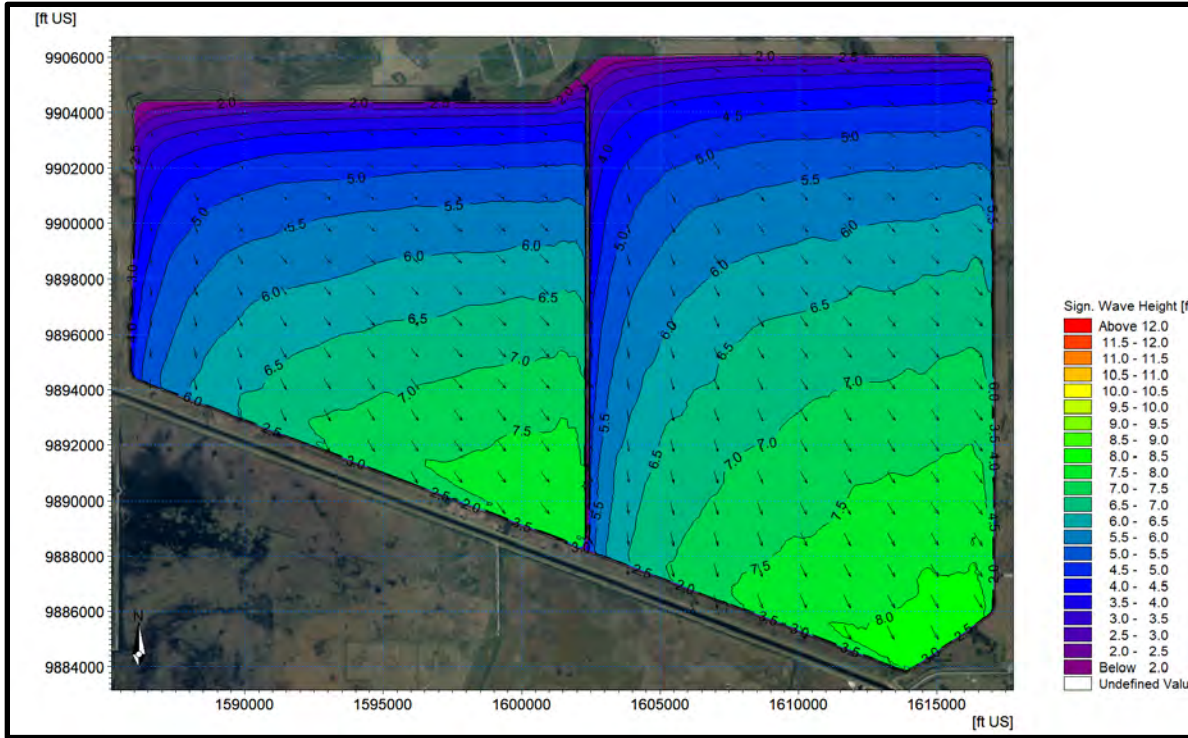


Figure 4-3. Wave Model Results - Design Case 1.

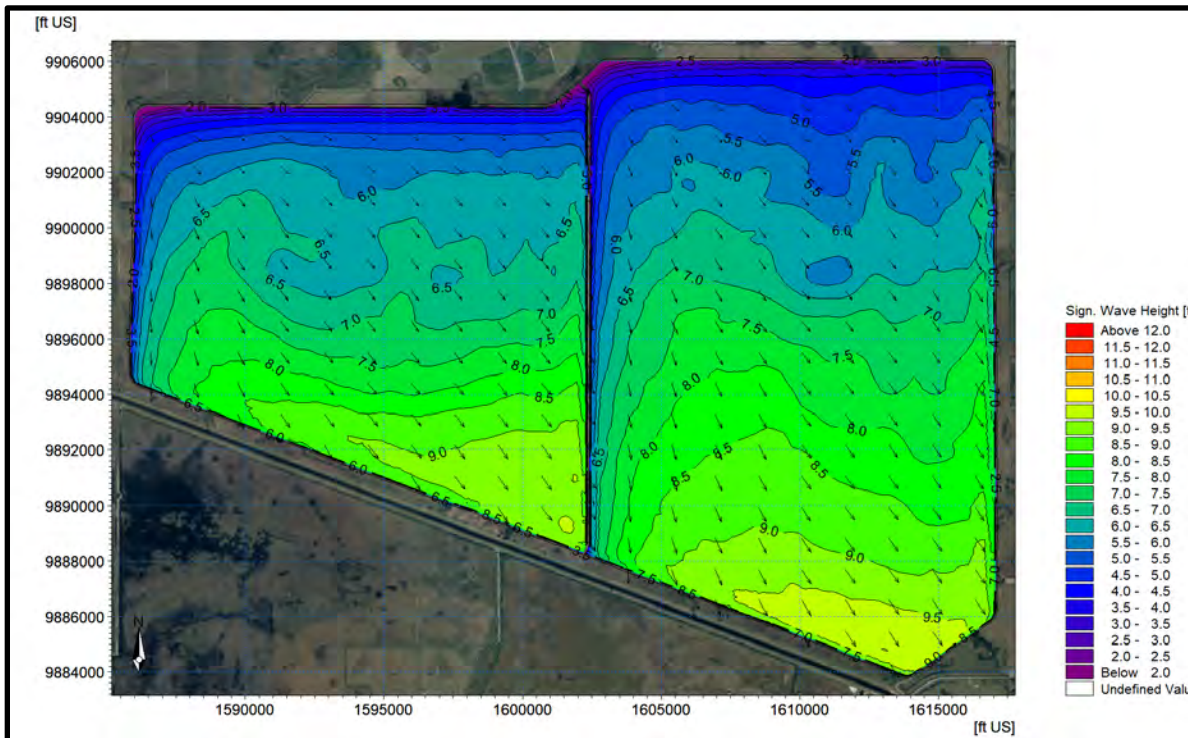


Figure 4-4. Wave Model Results - Design Case 2.

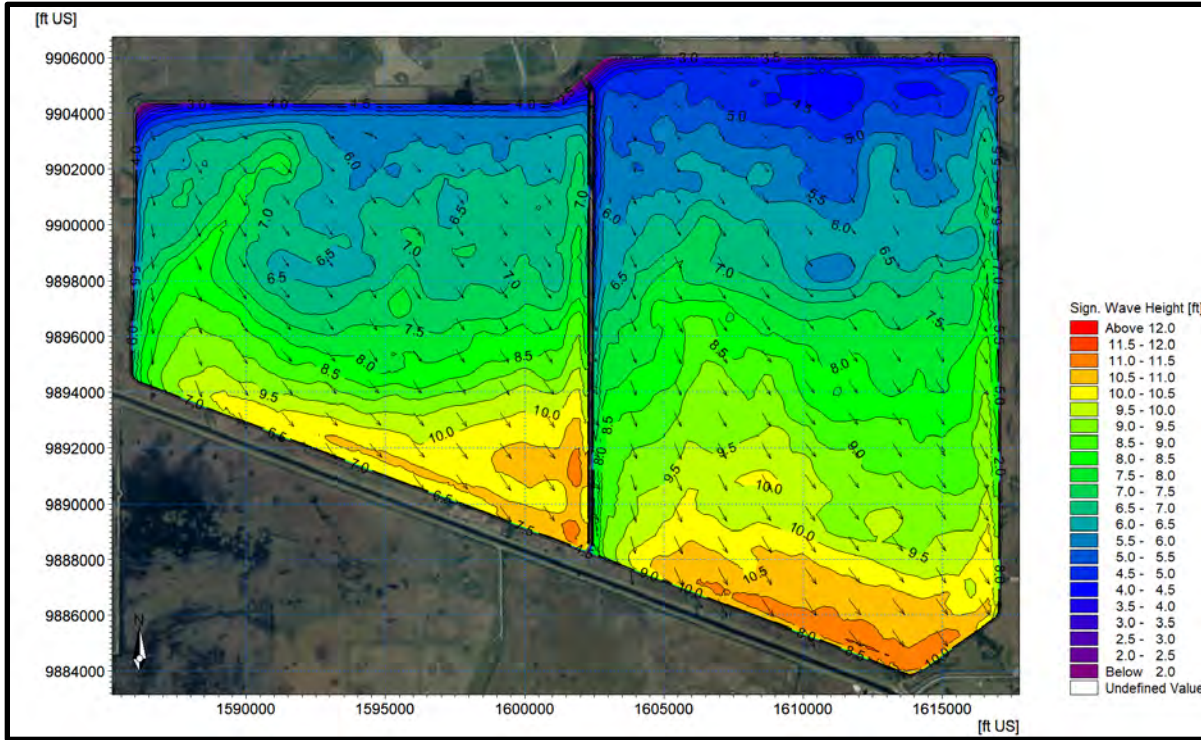


Figure 4-5. Wave Model Results – Design Case 3.

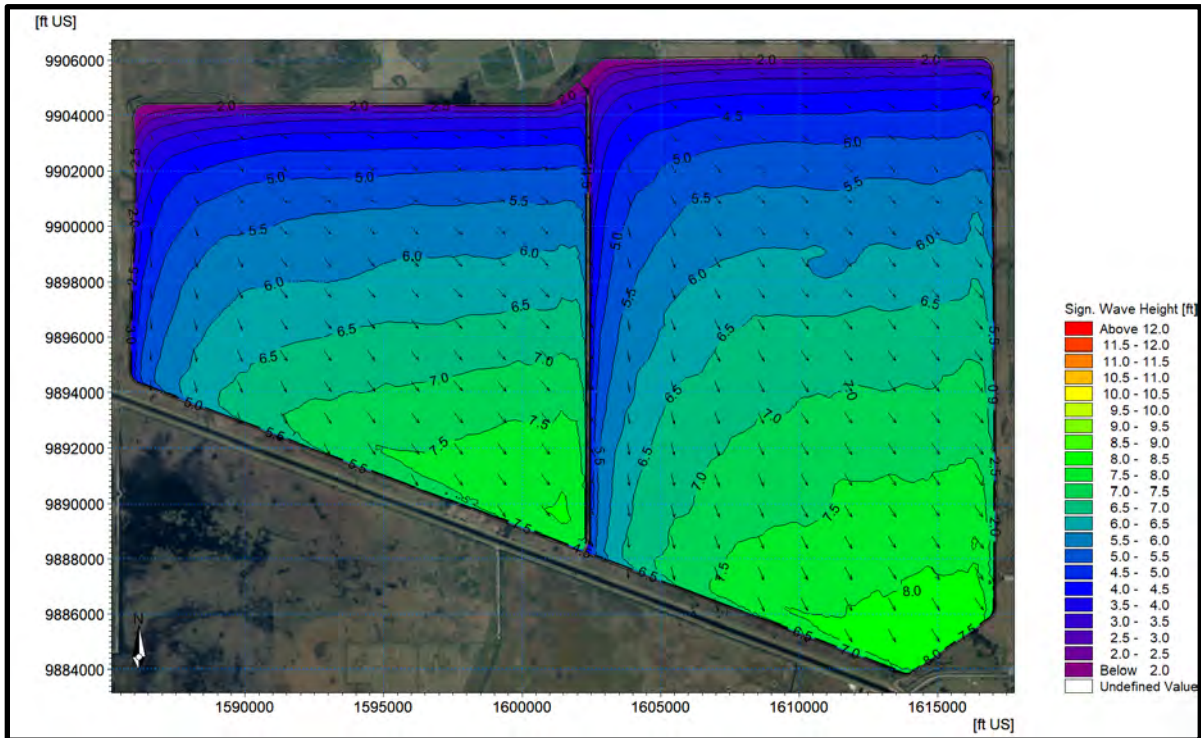


Figure 4-6. Wave Model Results – Design Case 4(a and b).

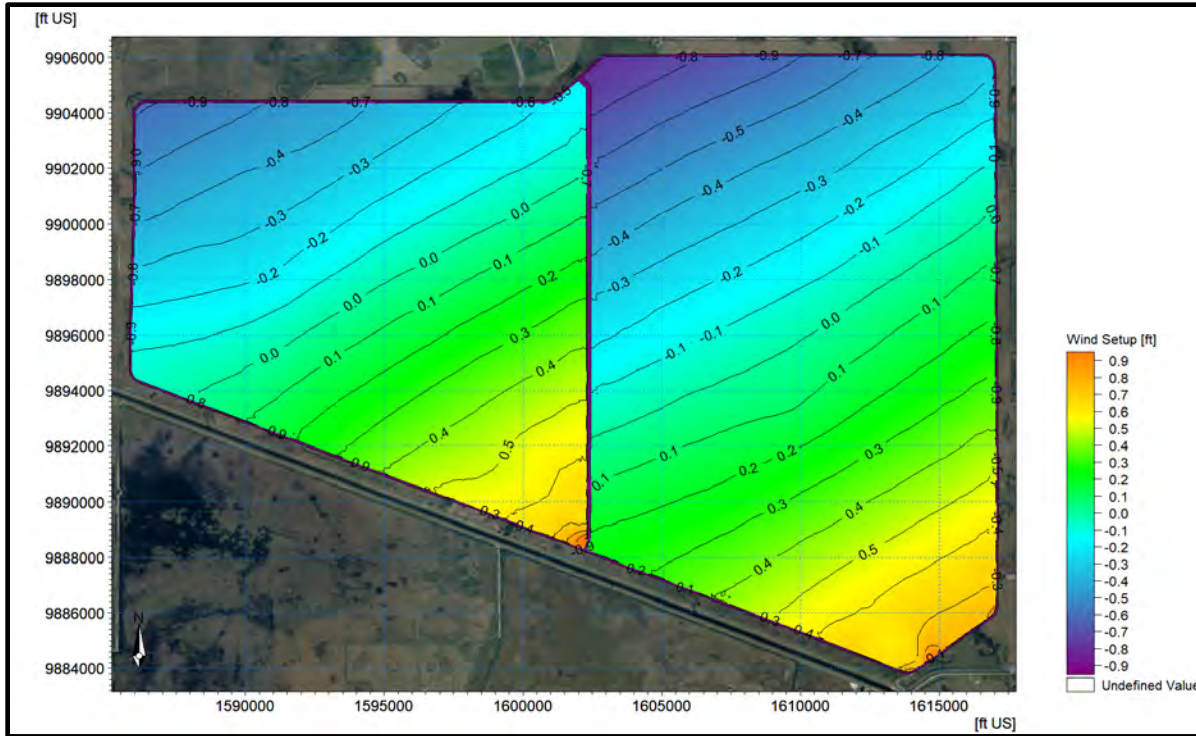


Figure 4-7. Wind Setup Model Results – Design Case 1.

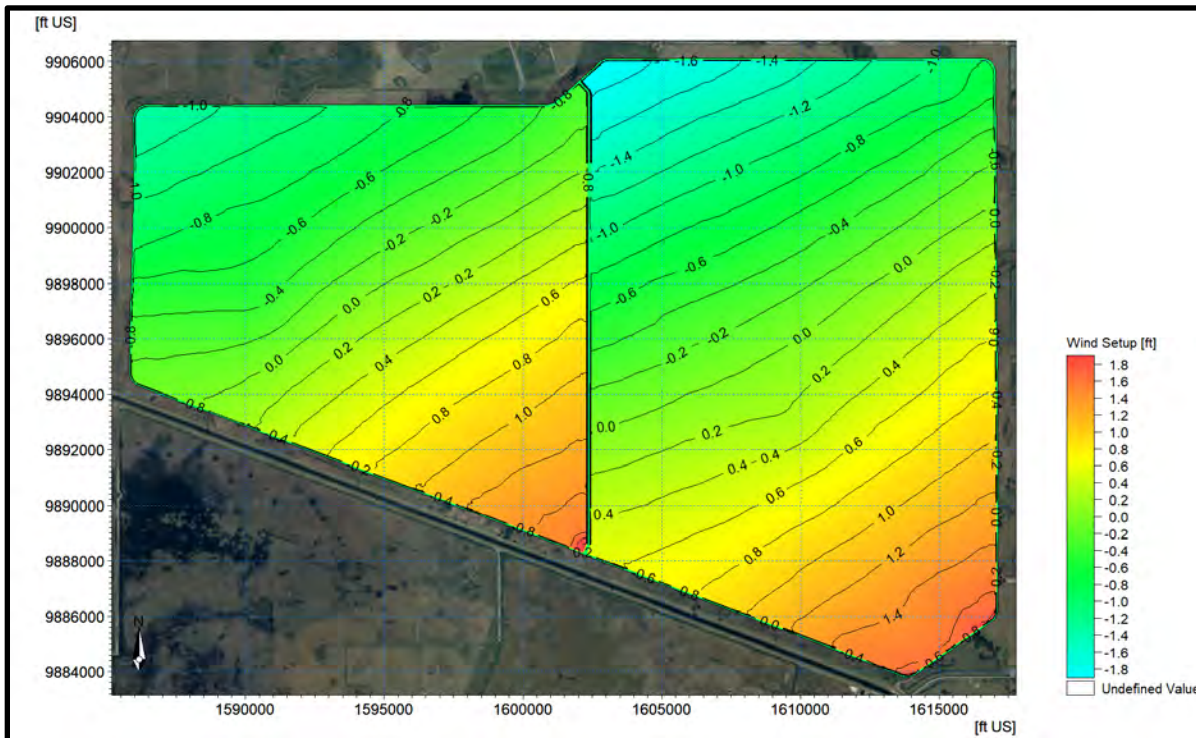


Figure 4-8. Wind Setup Model Results – Design Case 2.

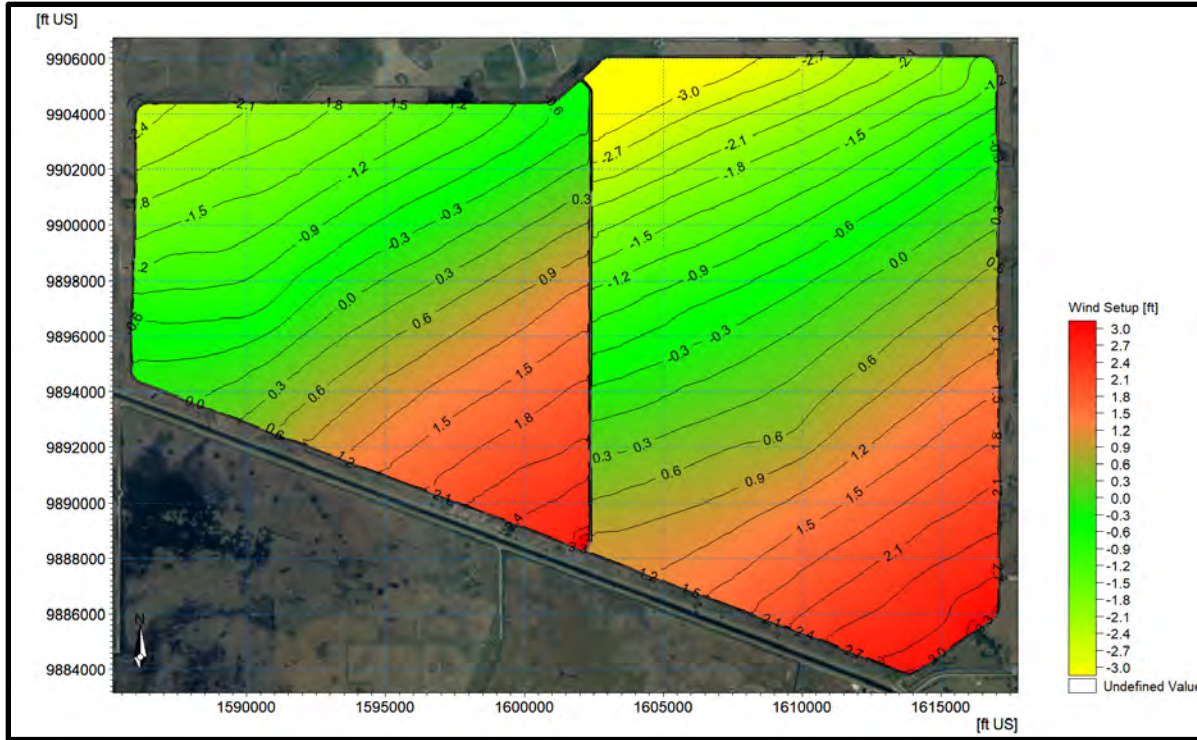


Figure 4-9. Wind Setup Model Results – Design Case 3.

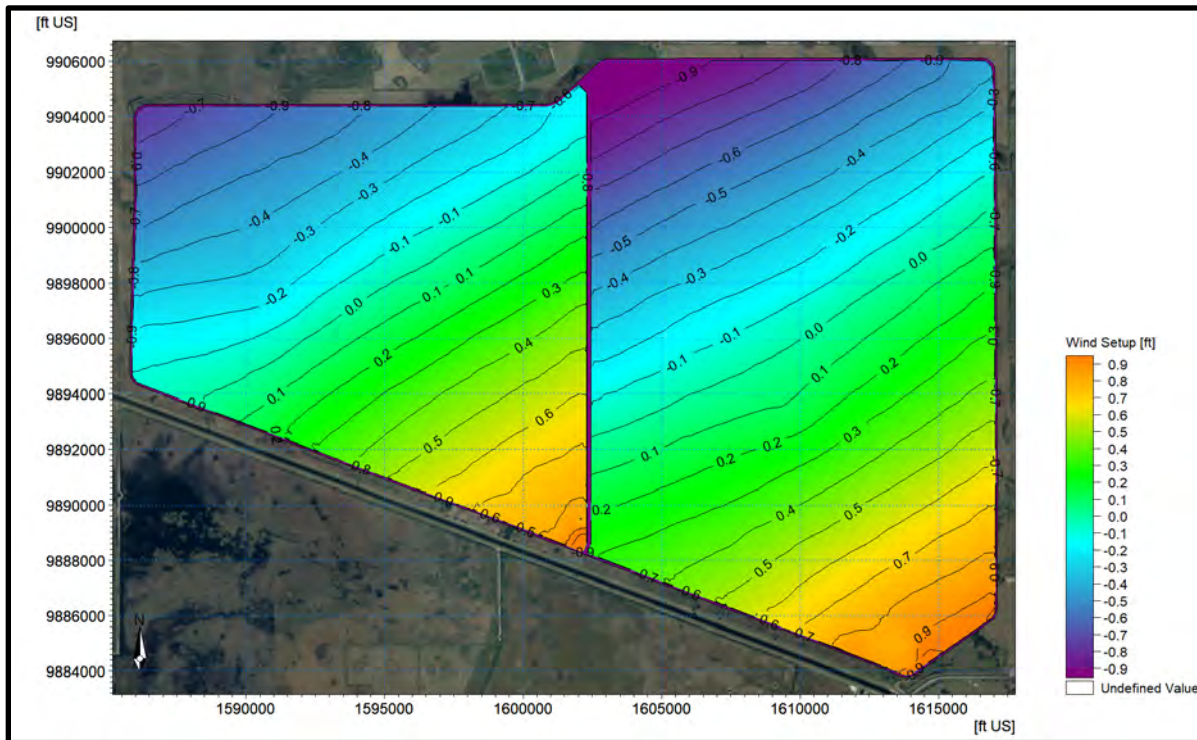


Figure 4-10. Wind Setup Model Results – Design Case 4a and 4b.

5.0 Overtopping Analysis

5.1 CFD Modeling Approach

J-Tech used the open-source model OpenFOAM and a specific solver interIsoFoam to perform CFD modeling of wave overtopping. The model is based on the Volume of Fluid (VOF) formulation and is suitable for modeling wave propagation, wave breaking, and wave/structure interactions in a numerical wave flume. The model solves the RANS equations with a kOmegaSST turbulence model defined. The interIsoFoam solver is derived from the interFOAM solver modified to use the isoAdvector scheme.

The Volume of Fluid (VOF) solver models the free surface using a α .water parameter to define the fraction of water in each cell, with a value of 0 representing 100% air and 1 for 100% water. A cell with a mix of water and air at the free surface will have a value between 0 and 1. This generates some smearing at the water surface, and the isoAdvector scheme is used to determine a more precise surface within those cells and deals with the sharp change from the 2 fluids. Schmitt et al, 2020 describes in more detail the OpenFOAM solvers and supports the use of interIsoFoam for modeling wave propagation.

The model was set up in a 2-dimensional geometry similar to that of a 2-dimensional wave flume in a physical modeling laboratory. In this configuration (as is also the case in a physical modeling lab) it is very difficult to generate waves at one end of the "flume" and achieve the design conditions at the toe of the structure for steep waves. The waves predicted by the MIKE21 model will break close to the point of wave generation in the CFD model due to the steepness of the waves and result in smaller waves by the time they reach the embankment. The MIKE21 wind/wave model used to model waves for input to the CFD model includes the effects of both white capping (i.e. wave breaking due to overly steep waves) and wave growth from the wind. The energy lost through white capping/wave breaking is replaced to a large extent by the high winds and in this way, large steep waves can be maintained in MIKE21 which cannot be maintained in a physical or CFD modeled wave flume that does not include the action of wind. In the CFD model (as well as in most physical labs) the energy input from the wind cannot be included and hence breaking reduces the overall wave height by the time it reaches the structure.

To overcome this the wave generator was moved to within 65 feet of the toe of the embankment (approximately one wavelength) and therefore most breaking of the largest waves will occur on the embankment as are likely to occur in reality.

A second modification made to ensure that too much energy was not lost before the waves broke on and ran up the embankment was to increase the wave heights in the model at the point of generation to attempt to match the wave height at the toe of the embankment with the target value. Wave height measurements were taken at the toe of the embankment and the wave height at the wave generator were increased until the waves at the structure matched the required wave conditions based on the MIKE21 SW model results.

The embankment surface roughness was defined as a smooth surface for the purpose of overtopping modeling. Modeling assumed that the embankment was impermeable, which is a reasonable assumption for the soil cement surface on the embankment slope and crown.

The model was run for approximately 1.7 hours of irregular waves (over 1000 waves) for each design case in order to have a sufficiently long timeseries to capture overtopping from the largest waves and calculate average overtopping rates. The mean discharge for the initial runs was plotted as a function of time to observe that the run length was sufficient so that the mean discharge converged on a single value and that large overtopping events had an insignificant impact on the resulting mean discharge.

The water levels were set equal to the stillwater levels from **Table 2-1** plus the wind setup from **Table 4-1**. The model generated irregular waves with characteristics defined by the significant wave heights and peak periods in **Table 4-1**.

Model results presented include average overtopping rates as well as the peak single wave overtopping volume for each model scenario.

5.2 Model Geometry

The embankment geometry was based on dimensions shown in **Figure 1-4**. It was assumed that the embankment height in **Figure 1-4** is the final height of the embankment and construction will account for settlement based on results of geotechnical analysis of the reservoir. As indicated above, to minimize the loss of energy, the inlet boundary was positioned approximately 65 feet from the toe of the embankment. The bottom elevation was set at 25 feet NAVD88, which was approximately the lowest elevation along the portion of the embankment coincident with the largest fetch direction.

The model utilized a nested grid with three levels of resolution as shown in **Figure 5-1**. These are:

- Level 0 – the lowest resolution with the largest cell size. This is the portion of the model above and behind the embankment that will not see water.
- Level 1 – an area with medium resolution that is on the reservoir side of the embankment in the area that contains water through which waves will be generated and propagate as well as along a portion on the back side of the embankment that could see overtopping flow.
- Level 2 – the highest resolution (smallest cell size) is located along the face of the embankment and around the wave wall

Two meshes were generated, a coarse mesh and a finer mesh, as a sensitivity test to ensure that the resolution was adequate so that the model would converge on the correct solution. The initial coarse model mesh was sized so that there was a minimum number of 10 cells along the vertical face of the crown wall to define the resolution in the Level 2 areas and a minimum of 150 cells within a wavelength in the Level 1 area. The finer mesh was sized similarly but with a minimum of 15 cells along the face of the crown wall and a similar increase in the resolution of the cell sizes for the other two levels. The finer mesh contained a total of approximately 160,000 cells: with Level 0 cells comprising about 10 percent, Level 1 cells approximately 70 percent, and Level 2 approximately 20 percent of the total.

The mesh cell sizes for both the coarse and finer model meshes are shown in **Table 5-1**.

Each mesh was generated in two steps. The initial step generated structured hexahedral meshes using the OpenFOAM command blockMesh with cell sizes as indicated in **Table 5-1**. These meshes were then modified using the command snappyHexMesh, adding higher definition (finer resolution) at surfaces and boundaries and

at critical locations where it's beneficial to have a smaller mesh, such as, at the inlet, along the wave propagation level and an even finer resolution where the waves hit the wall and overtopping occurs.

Models were run for over 1000 waves to characterize the mean overtopping discharge rates. Overtopping rates were measured at the rear face of the wave wall as shown in **Figure 5-1**. Comparison of the model results from the coarse and finer mesh model runs indicate that the model results converged, with average overtopping rate predictions within 10 percent of each other and it was concluded the resolution of the mesh is adequate with results within the expected variability for overtopping models.

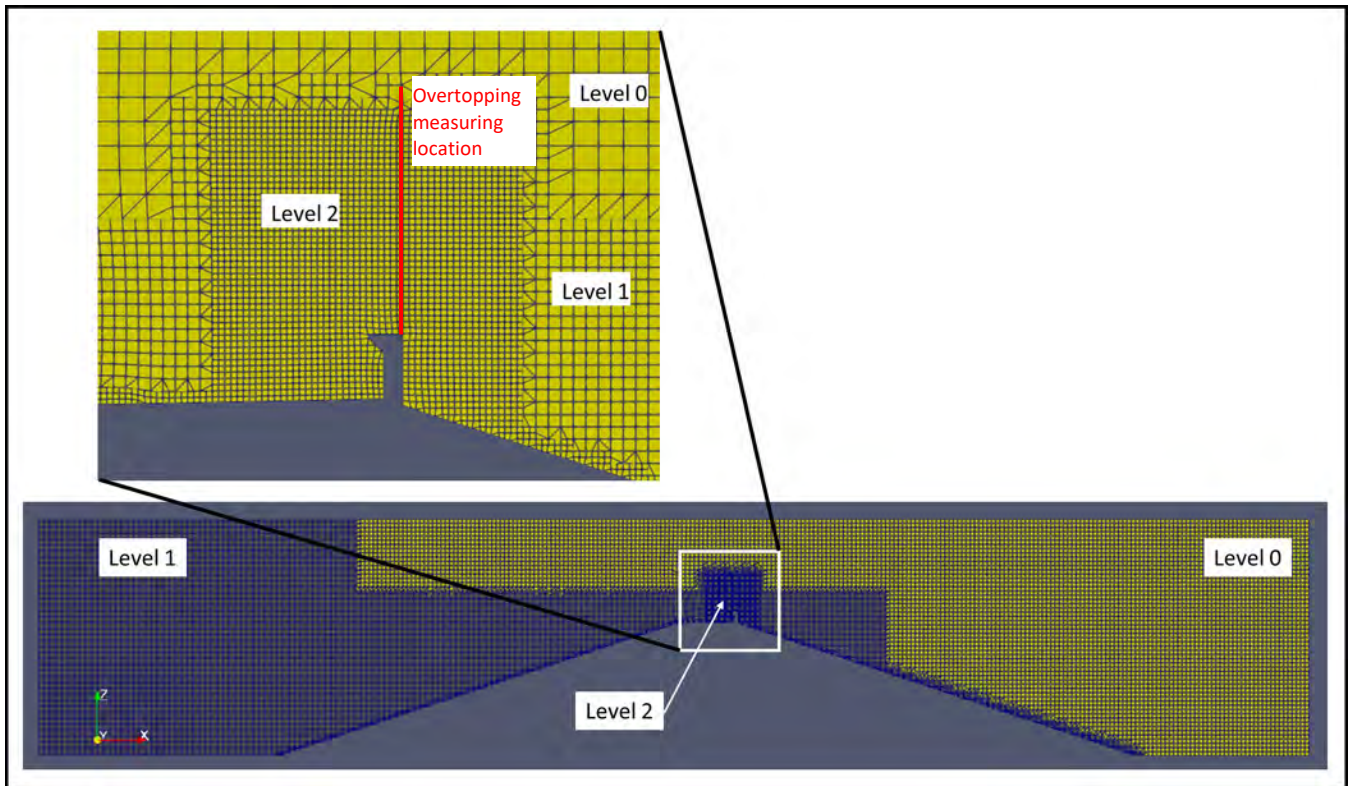


Figure 5-1 CFD Model Mesh for Wave Overtopping with Varying Levels of Mesh Resolution

Table 5-1 Mesh cell sizes

Mesh	Cell Size (m) ¹		
	Level 0	Level 1	Level 2
Coarse Mesh	0.4	0.2	0.1
Fine Mesh	0.27	0.13	0.067

¹ Cell size is the same in the x and z direction

5.3 Wave Inputs

Waves generated in the reservoir will appear somewhat chaotic with individual waves varying in height and period. These “irregular waves” will fit within a statistical distribution which is typically designated by the significant wave height, H_s , and the peak wave period, T_p . The significant wave height is defined as the average height of the largest 1/3 of the waves in the distribution. The peak period is the wave period that contains the peak energy in the wave spectrum. The wind/wave model results are given in terms of the significant wave height and the peak wave period.

A time series of individual waves was defined at the inlet boundary based on the wave heights and periods in **Table 4-1**. The OpenFOAM wave model `irregularMultiDirectional` was used to define the waves at the inlet, with a single simulated wave paddle and active wave absorption. Irregular waves were generated using a python script, described with a JONSWAP spectrum with 750 wave components. Each component has an associated wave height, wave period, phase and direction. The components phases are randomly defined, using a seed number. A single seed number was used for all model runs to ensure similar random wave conditions were evaluated for each design case.

5.4 Model Scenarios

Model runs were made for Design Cases 1, 2, 4a and 4b with a 3.5-foot-high crown wall with a bullnose as described in **Section 5.2**. Subsequently, additional scenarios were run for Design Cases 1, 2, and 3 with a 4.1-foot-high crown wall due to excessive overtopping for these cases with the 3.5-foot-high crown wall and for comparison with results from J-Tech (2023a). **Table 5-2** summarizes scenarios modeled and documented in this TM.

For all cases, overtopping was measured at the back of the crown wall as shown on **Figure 5-1**.

Table 5-2. Overtopping Scenarios Modeled.

Design Case	Wall Height (feet)	Stillwater Level (feet NAVD88)	Wind Setup (feet)	H_s (feet)	T_p (seconds)
1	4.0	56.3	0.9	8.2	4.8
2	4.0	52.7	2.0	10.5	5.2
3 ¹	4.1	50.6	3.4	12.1	5.3
4a	4.0	53.8	1.1	8.4	4.8
4b	4.0	54.4	1.1	8.5	4.8

¹ Model results presented for Design Case 3 are based on the initial model geometry shown in **Figure 1-2(a)**.

5.5 Results

A summary of results from the final model runs is shown in **Table 5-3**.

The table includes columns for the target wave height for waves at the toe of the structure and the achieved wave height based on measurements of waves at the toe of the embankment. For physical models, waves are generally achievable within +/- 5 percent of the target value. As noted in **Section 5.1** above, the wave maker for the CFD model was placed approximately one wavelength from the structure toe and the wave height the wave height at the wave maker was increased by 10 percent to account for some energy losses between the wave maker and structure toe. For Design Case 1, the wave height achieved was within 1 percent of the target wave height. For Design Cases 2 and 4 (a and b), the achieved wave height was within 7 percent. Because of the increased dissipation of wave energy observed for Design Cases 2 through 4 (a and b), an additional sensitivity run, listed as Design Case 2S, was performed in which the wave height at the wave maker was increased by an additional 10 percent for Design Case 2 conditions. This increased wave height resulted in the target wave height being met at the toe of the structure for Design Case 2.

Table 5-3. Summary of Overtopping Results

Design Case	Wall Height (feet)	Target Wave Height (feet)	Achieved Wave Height		Mean Overtopping (cfs/ft)	Peak Overtopping Volume (cf/ft)
			(feet)	(% of Target)		
1	4.0	8.2	8.3	101%	0.0015	2.9
2	4.0	10.5	10.4	99%	0.0570	28.6
3 ¹	4.1	12.1	11.0	91%	0.0816 ¹	71
4a	4.0	8.4	8.5	102%	0.002	2.6
4b	4.0	8.5	8.6	102%	0.0034	2.6

¹ Design Case 3 results are based on the initial reservoir geometry shown in **Figure 1-2(a)**. Design Case 3 is only for sensitivity purposes and was not re-run for the revised geometry and water level, nor were additional runs made to achieve the target wave height at the toe of the embankment.

cfs/ft = cubic feet per second per foot of embankment

cf/ft = cubic feet per foot of embankment

Based on the modeling documented in this TM, the geometry with a 4-foot-high crown wall with a bullnose meets the 0.005 cfs/ft threshold for Design Case 1 and Design Cases 4(a and b) but exceeds the threshold for Design Case 2. Overtopping is greatest for Design Case 3; however, Design Case 3 is included for sensitivity testing only and does not need to meet the threshold limits of other cases.

Excluding Design Case 3, the peak single wave overtopping volumes ranged from 2.6 cubic feet per foot for Design Case 4(a and b) to 28.6 cubic feet per foot for Design Case 2.

EurOtop (2018) guidelines limit peak overtopping volumes for grass covered slopes at 500 liters per second per meter (5.4 cubic feet per second per foot) for non-maintained grass cover, open spots, moss, and bare patches. These are met with a 4-foot wall for Design Cases 1 and 4(a and b), but exceeded by Design Case 2. Peak overtopping volume limits for slopes with maintained and closed grass cover increase to 2000 to 3000 liters per meter (21.5 to 32.3 cubic feet per foot) for maintained and closed grass cover. Design Cases 1, 4a and 4b meet this criteria for the entire range and Design Case 2 meets it for the upper limit.

6.0 Summary of Results

This TM presents the results of an analysis of wave growth and potential overtopping for the LOCAR reservoir for Design Cases 1 through 4 (a and b) shown in **Table 2-1**. The analysis includes the use of CFD modeling to model the wind speed throughout the reservoir as it transitions from land over the embankment and over the water, numerical modeling of wave growth based on a generated wind map, and CFD modeling to model overtopping by the resulting waves.

A parallel effort was performed and documented in J-Tech (2023a) to analyze overtopping utilizing more standard wind correction factors to adjust the wind speed for use in wave modeling, using the Zeider Zee method for calculating wind setup, modeling wave growth based on a constant adjusted windspeed using the US Army Corps of Engineers model STWAVE, and calculating overtopping rates based on procedures specified in EurOtop (2018).

Table 6-1 compares results for wave conditions and wind setup from this TM with the results from J-Tech (2023a). A comparison of overtopping results based on these conditions are presented in **Table 6-2** for the preliminary design embankment shown in **Figure 1-3** that includes a crown wall with a bullnose at the land side of a promenade. Results are shown for the East Cell with a wind approaching from 330 degrees True North.

Table 6-1. Wave and Wind Setup Results – East Cell.

Design Case	Traditional Approach ¹			Alternate Approach ¹		
	Hs (ft)	Tp (sec)	Wind setup (ft)	Hs (ft)	Tp (sec)	Wind setup (ft)
1	8.1	5.0	1.2	8.2	4.8	0.9
2	10.3	5.6	2.5	10.5	5.2	2.0
3	12.4	6.2	4.4	12.1	5.3	3.4
4a	8.3	5.0	1.4	8.4	4.8	1.1
4b	8.4	5.0	1.4	8.5	4.8	1.1

¹ Traditional Approach uses adjusted wind speeds based on USACE (2008) guidance with waves modeled using STWAVE. Alternate approach is based on CFD modeling of wind and wave modeling using MIKE21 SW with a cap on C_d of 0.0026.

Table 6-2. Overtopping Results – East Cell

Design Case	Traditional Approach			Alternate Approach		
	Wall Height (ft)	Avg Overtopping (cfs/ft)	Max Volume (cf/ft)	Wall Height (ft)	Avg Overtopping (cfs/ft)	Max Volume (cf/ft)
1	4.0	0.001	0.5	4.0	0.0015	2.9
2	4.0	0.005	1.5	4.0	0.0570	28.6
3	4.0	0.064	10.9	4.1	0.0816*	71
4a	4.0	0.001	0.3	4.0	0.002	2.6
4b	4.0	0.001	0.4	4.0	0.0034	2.6

* Target wave heights were not met at the toe of the revetment for Design Case 3.

6.1 Discussion

The approach in J-Tech (2023a) applies a constant wind over the reservoir with a magnitude that is 20 percent greater than the overland wind speed. For the CFD approach, wind varied over the surface of the reservoir, with the peak wind speed only about 12 percent greater than the overland wind speed. Although modeling in this TM utilized reduced wind speeds for Design Cases 1 and 4 (a and b) compared with the analysis in J-Tech (2023a), comparison of wave modeling estimates shows both approaches resulted in similar wave heights (but with longer wave periods using the approach in J-Tech (2023a)).

The main reason for similar wave conditions from each approach can be attributed to the drag coefficient between the air and water, C_D , which determines the rate of momentum transfer from the wind to the waves. This coefficient was capped at a value of 0.0026 for waves generated from wind modeled using the CFD approach. This should be considered to be a conservative value based on a review of available data in the literature. A review of the C_D formulation used in STWAVE shows that, although both models increase the drag coefficient linearly with wind speed, the drag coefficient used in STWAVE increases more gradually, with a drag coefficient of approximately 0.0023 for the wind speeds modeled for Cases 1 and 4 (a and b), and 0.0026 for Case 2 (in which both approaches used the same overwater wind speeds).

Wind setup values predicted using the analysis in this TM were lower for all four design cases than those from J-Tech (2023a). This is consistent with the lower wind speeds used in Design Cases 1 and 4(a and b), but also was

the case for Design Cases 2 and 3 which used the same overwater wind speed for both approaches. It is noted that the MIKE21 HD hydrodynamic model used to model wind setup used the same 0.0026 drag coefficient as the wave model and so these predicted setup values should be considered to be conservative.

The resulting overtopping for Design Cases 1 and 4 (a and b) were similar for both approaches, although with slightly different wave conditions and different wind setup values. Design Case 2, which utilized the same wind speed and which resulted in similar wave conditions, resulted in over an order of magnitude difference in overtopping predictions.

Differences in predicted overtopping for Design Case 2 are attributed to between the empirical EurOtop formulations, which use influence factors to account for reductions in overtopping due to various features of the embankment (such as the promenade, the vertical wall, and the bullnose incorporated into the wall), and CFD, which directly models the interaction between the waves and the structures. It is noted that there is a discontinuity in the calculation in influence factors for walls with bullnoses in the EurOtop equations, which results in a significant decrease (a factor of approximately 5) in calculated overtopping for Design Case 2 with a wall height of 4.1 feet. Uncertainties with how well empirical formulations, modified by influence factors to account for variations in actual geometry of the embankment, predict the actual overtopping are one reason that physical modeling is typically a part of the design process for these structures.

CFD modeling can be considered to be comparable to physical modeling for many applications. The increase in overtopping for Design Case 2 may be due to physical interactions between the water and the structure that are not accounted for in a more generic empirical approach. For example, water that reflects off the crown wall and lands back on the promenade may not drain sufficiently in some instances so that the next wave that runs up the embankment builds on top of the remaining water, resulting in more overtopping than if the accumulated water was not there. The actual cause of the elevated overtopping level has not been determined but is felt likely to be due to a physical effect that is not captured in the empirical EurOtop approach.

Physical models, CFD models, and the EurOtop empirical formulas all carry uncertainties with them.

For physical and CFD models, the input wave conditions represent time series of random waves that conform to a given energy density spectrum. The time series generated from a given spectrum depends on the seeding number used for the random number generator used to determine the distribution of the random starting phases of the incident wave sequences that share the spectrum. Overtopping rates will vary depending on the seeding number used to generate the wave time series, even though they share a common wave energy spectrum with identical significant wave heights and peak periods.

Romano et al (2014) and Williams et al (2014) investigated uncertainties in laboratory and numerical predictions of wave overtopping due to different seeding for inlet wave time series. Variability ranged from about 20 percent for cases with dimensionless relative freeboard¹ less than about 1.2 (representing cases with relatively large amounts of overtopping) to an order of magnitude when the relative freeboard is greater than 1.69 (representing cases with a low percentage of waves overtopping the structure).

¹ The relative freeboard, R^* , is the freeboard, R_c , divided by the significant wave height, H_s .

Romano et al (2014) compares variability of physical models with confidence levels for EurOtop formulas and notes that the modeled variability was always on order of magnitude smaller than that associated with the empirical formulas.

EurOtop equations used in J-Tech (2023a) are meant for a “design and assessment” overtopping analysis and add one standard deviation above the predicted mean value, so include a factor of safety. The EurOtop equations used in J-Tech (2023a) include uncertainties associated with the inherent spread in the data used to develop the equations as well as how well the influence factors for the promenade, vertical wall, and bullnose in combination represent the LOCAR reservoir. They are also based on unbroken waves, which will not be the case for the steep waves that will be generated in the reservoir and will break on the embankment.

6.2 Conclusions and Recommendations

The traditional approach for analysis of reservoir freeboard, documented in J-Tech (2023a), is widely accepted for preliminary design estimates and should be used for preliminary design purposes. This approach, as with all approaches to assessing overtopping includes certain levels of uncertainty. Wave conditions modeled under the high design winds are outside of the ability of most physical modeling labs to model and, therefore, outside of the range of most empirical equations. For the purposes of the Feasibility Study, it is recommended that the result of traditional approach be utilized for the proposed embankment height, wall configuration and overwash predictions for cost evaluations.

The analysis documented in this TM utilizes CFD and other physics-based numerical modeling tools to reduce the uncertainties associated with more empirical approaches and guidance that may not fully apply to a perched reservoir under the influence of hurricane force winds.

Like physical models, CFD models can simulate actual interactions between the fluid and structures (such as wind transitioning from overground to overwater for a perched reservoir, or waves running up an embankment and impacting/overtopping a crown wall). Numerical spectral wave and hydrodynamic models provide a robust means of predicting wave conditions and wind setup within the reservoir but are sensitive to the drag coefficient used to model the interaction between the wind and water surface.

The formulation used in the MIKE21 SW model, with a cap on C_d of 0.036 is likely overly conservative at high wind speeds based published data. The cap of 0.026 used for this analysis is consistent with the conservative (high) side of the published data. Other models such as STWAVE and the Delft SWAN model use formulations that are lower for portions (or all) of the wind speed ranges for the scenarios considered for this design. It is recommended that modeling for future phases of the design consider reducing this value based on a more thorough review of published data and model representations. A reduction in the drag coefficient would affect both the size of the design waves and wind setup – both resulting in lowering freeboard requirements.

Results of CFD modeling of the overtopping flows for Design Case 2 suggest some hydraulic effects that are not captured by the EurOtop equations may be leading to increased overtopping for this case. Reduction of these flows should be a focus of the detailed design. Conversely, the inherent variability of random waves at the model inlet could also be a factor that accounts for higher overtopping flows. Recommendations for future design stages include:

- Consideration of appropriate reductions in the drag coefficient used in the wave growth and hydrodynamic models consistent with recent published research as well as formulations used in other similar models
- Performing additional CFD overtopping model runs using a range of seeding numbers to observe effects of variability due to random wave conditions.
- Incorporating features that could reduce overtopping in areas that are most prone to the highest waves and water levels. Features could include changes to the geometry of the embankments or addition of roughness elements on the embankment slopes in these areas.

Overtopping modeling results are based on a 2-dimensional CFD model of the cross section of the embankment. In a reservoir, 3-dimensional effects that are not captured by the 2-dimensional model can also affect overtopping flows due to the nature or the locally generated waves. It is also recommended that 3-dimensional modeling also be performed during future design stages to address these effects.

7.0 References

Bryant and Akbar, 2016. Review – An Exploration of Wind Stress Calculation Techniques in Hurricane Storm Surge Modeling. By Kyra M Bryant and Muhammad Akbar. *Journal of Marine Science and Engineering*.

Burton, T., Jenkins, N., Sharpe, D. and Bossanyi, E., 2011. *Wind energy handbook*. John Wiley & Sons.

Curcic and Haus, 2020. Revised Estimates of Ocean Surface Drag in Strong Winds. *Geophysical Research Letters*, 47, e2020GL087647. <https://doi.org/10.1029/2020GL087647>.

EurOtop, 2018. Manual on wave overtopping of sea defences and related structures. An overtopping manual largely based on European research, but for worldwide application. Second Edition 2018. Van der Meer, J.W., Allsop, N.W.H., Bruce, T., De Rouck, J., Kortenhaus, A., Pullen, T., Schüttrumpf, H., Troch, P. and Zanuttigh, B., www.overtopping-manual.com.

Haapala, J., Arnold, T., Shen, Y., Partney, S., Tucker, R., Hadley, L., and Smith, S. 2006. *Design Criteria Memorandum: DCM-2, Wind and Precipitation*, February 2006.

Hargreaves, D.M. and Wright, N.G., 2007. On the use of the k-ε model in commercial CFD software to model the neutral atmospheric boundary layer. *Journal of wind engineering and industrial aerodynamics*, 95(5), pp.355-369.

J-Tech, 2023a. Lake Okeechobee Component A Storage Reservoir Feasibility Study – Wave and Overtopping Analysis. Draft Technical Memorandum. Prepared for: South Florida Water Management District. Prepared by: J-Tech, an Alliance between Jacobs Engineering and Tetra Tech, Inc. August 11, 2023.

J-Tech, 2023b. Lake Okeechobee Compartment A Storage Reservoir PMP Determination and PMF Routing. Draft Technical Memorandum. Prepared for : South Florida Water Management District. Prepared by: Collective Water Resources, LLC, August 8, 2023.

OpenFOAM, 2023. OpenFOAM: User Guide v2112. The open source CFD toolbox. [OpenFOAM: User Guide: simpleFoam](#) Accessed July 7, 2023.

Romano et al, 2014. About some uncertainties in the physical and numerical modeling of wave overtopping over coastal structures. By A. Romano, H.E. Williams, G. Bellotti, R. Briganti, N. Dodd, L. Franco. *Coastal Engineering* 2014.

SFWMD, 2020. Environmental Resource Permit Information Manual. Regulation Division, South Florida Water Management District. 2020

Schmitt, et al, 2020. Beyond VoF: alternative OpenFOAM solvers for numerical wave tanks. Schmitt, P., Windt, C., and Davidson, J. *J. Ocean Eng. Mar. Energy* 6, 277–292 (2020).

USACE, 2008. Coastal Engineering Manual. Chapter 2, Meteorology and Wave Climate. EM 1110-2-1100 (Part II) (Change 2). United States Army Corps of Engineers. 1 August 2008.

Williams et al, 2014. The role of offshore boundary conditions in the uncertainty of numerical prediction of wave overtopping using non-linear shallow water equations. By H.E. Williams, R. Briganti, and T. Pullen. *Coastal Engineering*, 89:30-44, 2014.

South Florida Water Management District

Lake Okeechobee Component “A” Reservoir (LOCAR) Model Documentation Report

July 25, 2023

1.0 Overview

Identification

The Lake Okeechobee Component “A” Reservoir (LOCAR) Project is an expedited planning effort undertaken as part of the Comprehensive Everglades Restoration Plan (CERP). The project seeks to identify above ground reservoir storage north of Lake Okeechobee (see **Figure 1.1**) consistent with the conceptual feature identified in CERP. This planning effort is undertaken by the South Florida Water Management District (SFWMD) and is implemented through Section 203 of the Water Resources Development Act (WRDA) of 1986, as amended by Section 1014(a) of the Water Resources Reform and Development Act (WRRDA) of 2014 (33 U.S.C. § 2231). Section 203 authorizes non-Federal interests to undertake feasibility studies of proposed water resources development projects for submission to the Secretary of the Army.

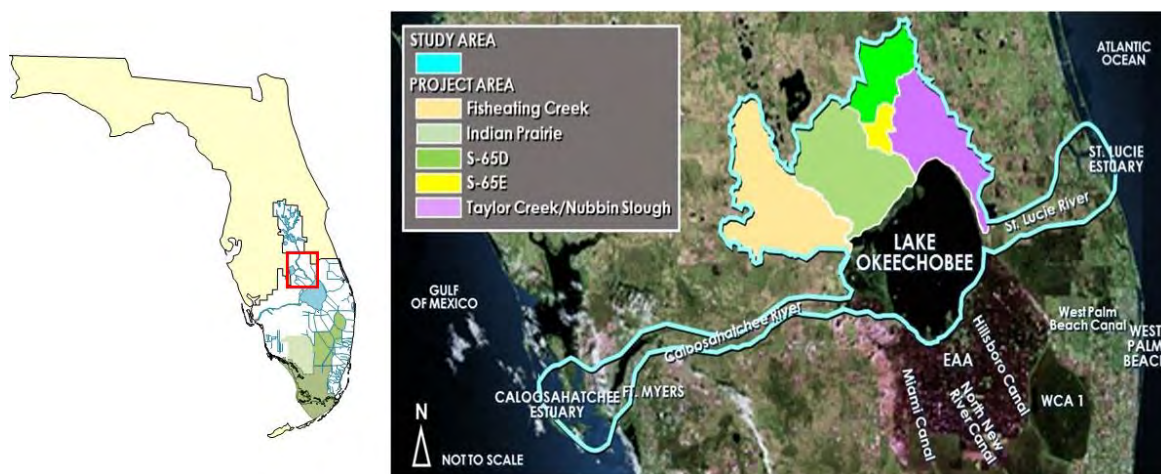


Figure 1.1. LOCAR Study Area

Modeling support to the LOCAR effort was provided by a team comprised of modelers from the Modeling Section of the Hydrology & Hydraulics Bureau of the SFWMD. The

planning team consisted of SFWMD staff, SFWMD project contractor J-Tech and reservoir consultants from Jacobs Engineering. Public scoping and formulation discussions were considered throughout the process. The focus of the LOCAR effort seeks benefits in the northern part of the South Florida watershed, in particular seeking hydrologic and ecologic benefits to Lake Okeechobee, the Northern (St. Lucie and Caloosahatchee) Estuaries and the Lake Okeechobee Service Area including supply to the Seminole Brighton Reservation. From a formulation perspective, LOCAR seeks to maintain flow south toward the Everglades consistent with the previously authorized EAA Storage Reservoir performance. Specifically, the goal of the LOCAR Project is to identify a ~200,000 ac-ft above ground storage reservoir (consistent with the CERP authorization of Component A) while balancing congressionally authorized projects including:

- Enhance ecology in Lake Okeechobee.
- Enhance ecology in northern (St. Lucie & Caloosahatchee) estuaries.
- Improve water supply performance.

Scope and Objectives

Modeling support for LOCAR focused on working with the project planning team and other interested parties to formulate and test project features leading to the ultimate identification of a tentatively selected plan (TSP). Modeling products were developed at the appropriate level to support a detailed representation of project features and to provide information for all evaluations required for plan development and documentation in the 203 Feasibility Study Report. The project modeling and plan formulation framework is built upon work already completed as part of other CERP and South Florida planning efforts and utilizes the same tools and techniques as used by the CERP Interagency Modeling Center (IMC). In particular, the modeling strategy is generally consistent with the parallel planning efforts for the CERP Lake Okeechobee Watershed Restoration Project (LOWRP) (IMC, 2019a) and the modeling tools and assumptions closely match and leverage work from the recently completed Lake Okeechobee Systems Operating Manual (LOSOM) (IMC, 2021a & 2021b) and the ongoing Biscayne Bay and Southeastern Everglades Ecosystem Restoration (BBSEER) Project (IMC, 2022b).

The primary model support tools utilized in LOCAR is the Regional Simulation Model Basins (RSMBN), the same model used to represent this part of the system in planning efforts for LOSOM, the EAA reservoir, LOWRP, etc... Unlike other CERP efforts that typically also employ the Regional Simulation Model Glades-LECSA (RSMGL) and the Dynamic Model for Stormwater Treatment Areas (DMSTA) models, this project focused on RSMBN application since maintaining flows south is a primary goal of the effort and significant changes to the systems south of Lake Okeechobee were not anticipated. This Model Documentation Report (MDR) describes the assumptions, model implementation steps and observed outcomes associated with modeling representations of both the current and future without project condition baseline model scenarios as well as the proposed project alternatives as simulated with the RSMBN. These model runs were predominantly used as a basis of comparison for many of the evaluations performed in

support of plan formulation and project assurances assessment. This document will focus on the modeling details of these scenarios.

2.0 Basis

Project Assumptions

This MDR describes the assumptions, model implementation steps and observed outcomes associated with modeling the following scenarios:

LOCAR Plan Formulation & Assurances Scenarios

- 2023 Existing Condition Baseline (ECB23L)
- Future Without Project Baseline (FWOL)
- LOCAR Reservoir Alternative 1 (LCR1)
- LOCAR Reservoir Alternative 2 (LCR2)
- LOCAR Reservoir Alternative 3 (LCR3)

The starting points for LOCAR modeling was the RSMBN work prepared as part of the IMC BBSEER project support (which heavily leverages the LOSOM project modeling) and utilizes the extended period of record modeling encompassing 1965-2016 climate stressors (**SFWMD, 2022**). The existing conditions baseline scenarios attempt to model assumed hydrologic conditions circa a defined date (e.g., 2023 at LOCAR project initiation for the ECB23L scenario) and includes current or imminent system infrastructure assumptions and current or imminent operational practices. The future projected conditions (both the baseline and the alternatives) include, relative to existing conditions, additional representations of planned future project activities, including state, federal and Central Everglades Restoration Project (CERP) projects as shown in **Figure 2.1**. Detailed project assumption tables for the baseline scenario are consistent with those assumptions made for the parallel CERP BBSEER project and are provided in **Appendix A**.

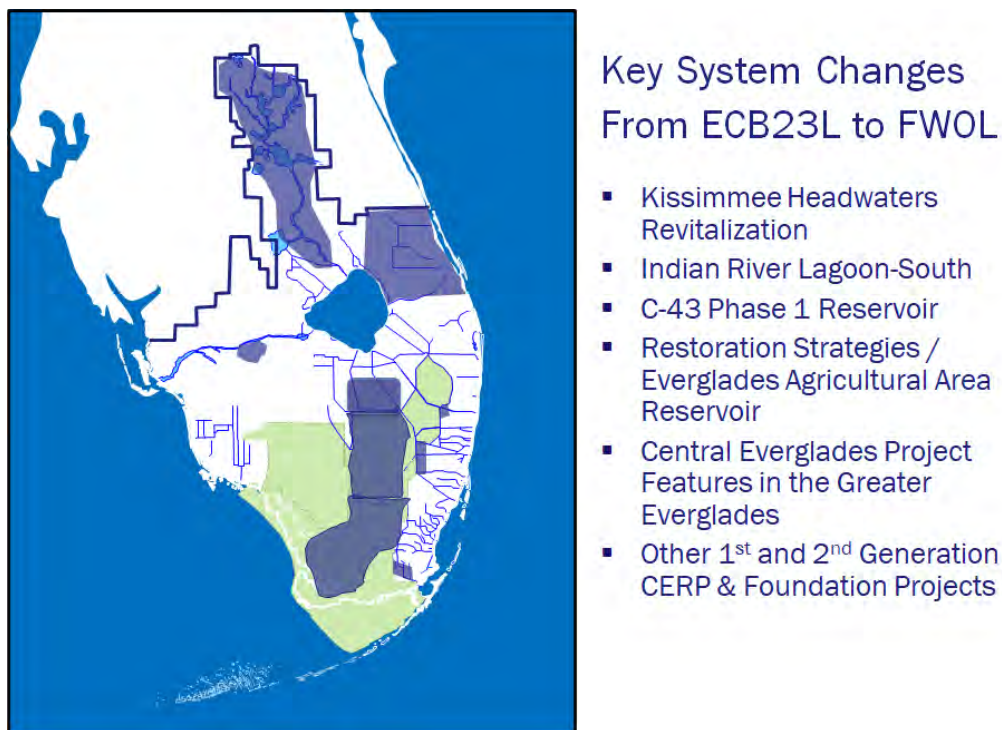


Figure 2.1. Key System Changes from Current (ECB23L) to Future Without Project (FWOL) Conditions

Each alternative scenario attempts to simulate the effect of the addition of a particular LOCAR reservoir configuration on the FWOL scenario. Although each scenario simulates 200,000 acre-ft of storage, each has a different spatial extent and reservoir full stage level, shown in **Figures 2.1** through **2.3**. In addition to the reservoir features, each alternative includes infrastructure improvements to allow water to be routed from Lake Okeechobee to the storage feature and release structures that can return water to the C41 & C41 A canals. The sizing of this reservoir inflow & outflow infrastructure is assumed to be 1,500 cfs as previously designed for a similar storage feature in the C43 basin. This inflow capacity allows filling of the reservoir within ~2 months, thereby allowing the reservoir to act as a surge tank capable of relieving high Lake Okeechobee stages. It is important to note that the information available for any particular model run may be slightly different from final project details as current system, future planned project activities and LOCAR storage design features evolve with time.



Figure 2.1. LOCAR Alternative 1 (LCR1)

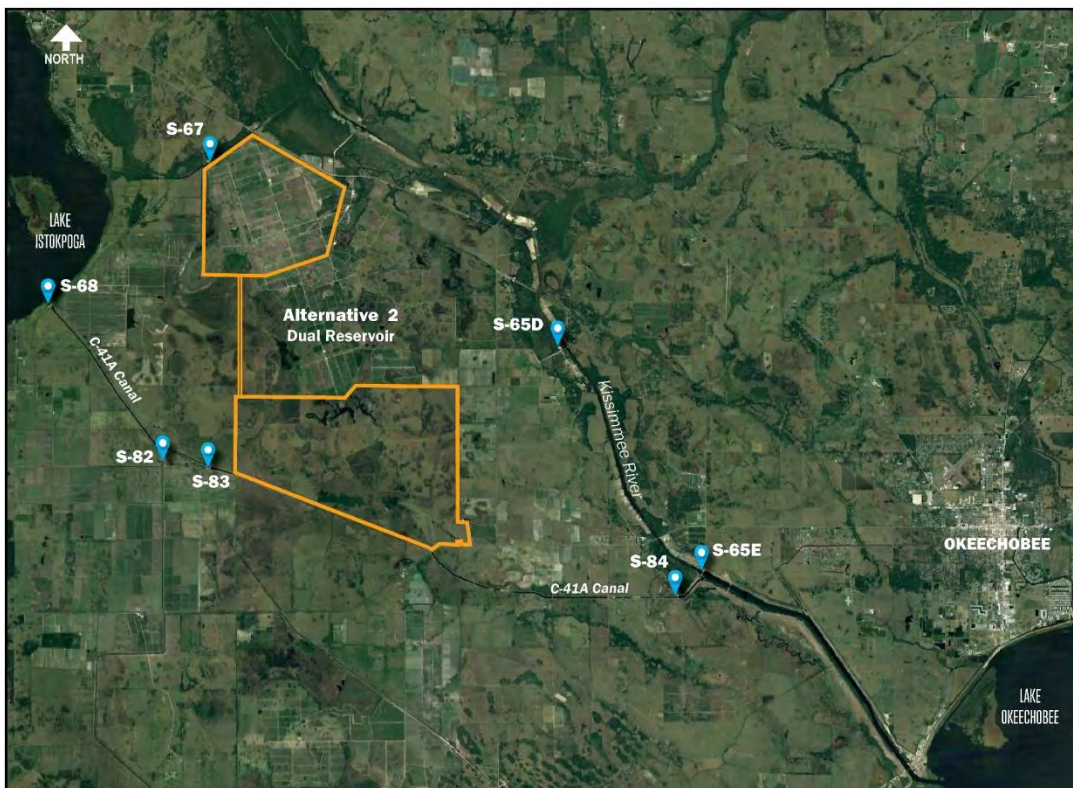


Figure 2.2. LOCAR Alternative 2 (LCR2)

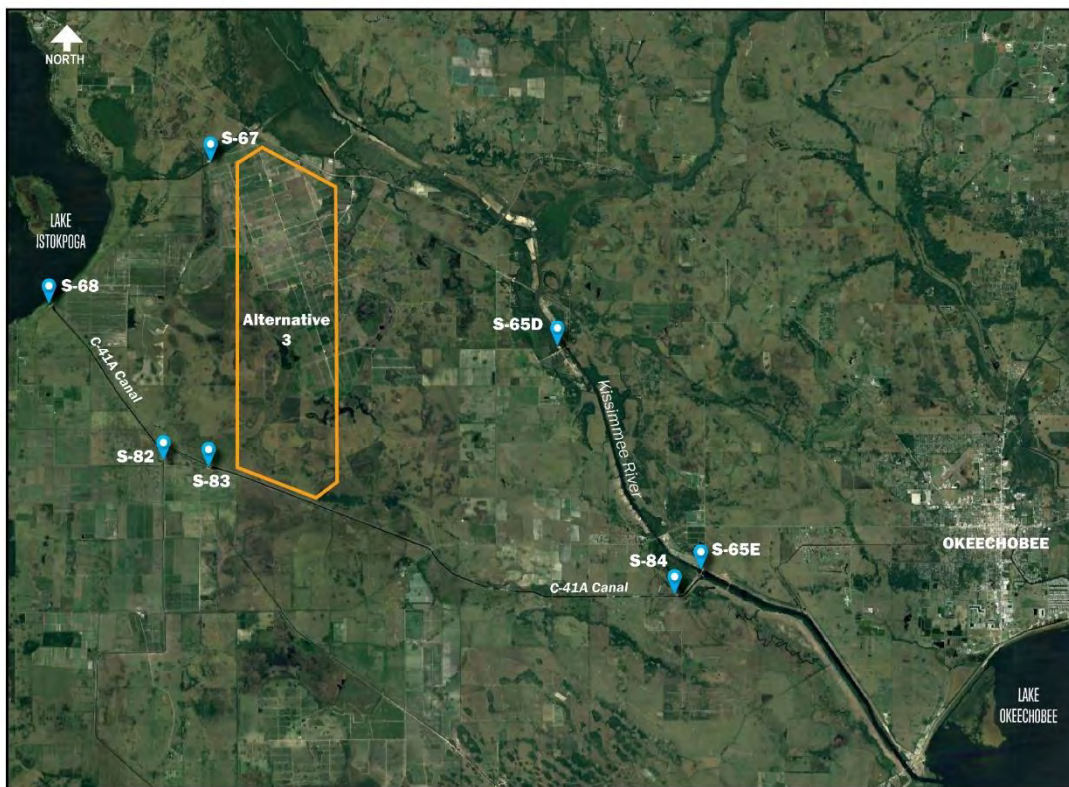


Figure 2.3. LOCAR Alternative 3 (LCR3)

Model Limitations and Intended Use of Results

The primary modeling products were evaluated based on outputs from the Regional Simulation Model (RSM) (SFWMD, 2005a and 2005b). The RSM is a robust and complex regional scale model. Due to the scale of the model, it is frequently necessary to implement abstractions of system infrastructure and operations that would, in general, mimic the intent and result of the desired project features while not matching the exact mechanism by which these results would be obtained in the real world. Additionally, it is necessary to work within established paradigms and foundations within the model code (e.g., use available input-driven options to represent more complex project operations). The RSMBN (VanZee, 2011 and SFWMD, 2021) model was reviewed through the USACE validation process for engineering software, as part of CEPP (USACE, 2014). The RSM was classified as “allowed for use” for south Florida applications in August 2012.

3.0 Simulation

Modeling Tools Used

RSM version 4.0.15 was used to run the RSMBN model.
Release date 5/6/2022, Source code repository: <https://github.com/sfwmd-git/rsm-base>.

The LOCAR scenarios were developed using the RSMBN model. Collectively, the model link-node network covers the spatial extent of the project planning area as shown in **Figure 3.1**. The period of simulation for the model utilizes a climate record from 1965 to 2016.

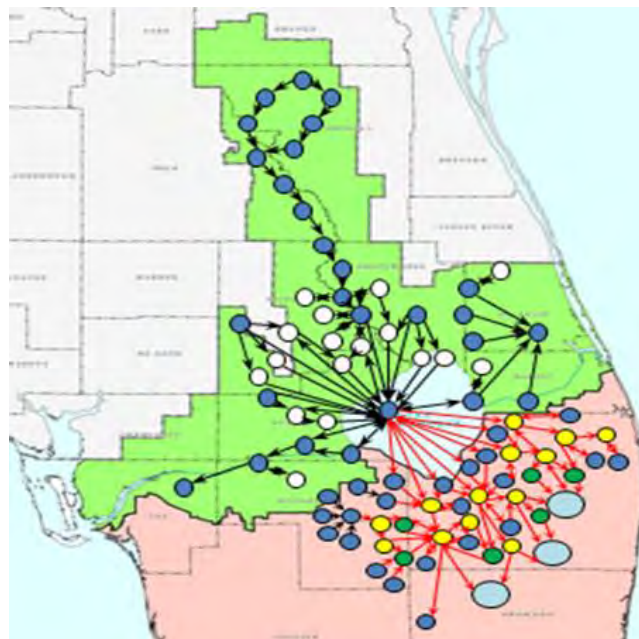


Figure 3.1. RSMBN Model.

The remainder of this section will focus on the project plan formulation baselines of the ECB23L and FWOL scenarios and the LOCAR alternative scenarios to describe model implementation. In general, the assumed modeled data sets (e.g., topography, water control districts, etc...) and/or system features (structure operations, etc...) are consistent with the previous planning exercises, unless identified as changed in this section or the assumptions tables in **Appendix A**.

3.1 Baseline Model Set Up

Within the project area, significant differences exist in the areas north, east, west and south of Lake Okeechobee as well as in the assumed operations for the Lake itself. The subsequent sub-sections will explain the modeling setup for each of these areas as

assumed in the ECB23L and FWOL scenarios. Details about project intent can be found in the associated project reports for each effort.

Kissimmee River Restoration

Several projects seek to improve the water resource management and ecosystem performance for the Kissimmee River and the Upper Chain of Lakes (**SFWMD, 2007**). As considered in the RSMBN model, the following assumptions are made for operations at S65 and state of Kissimmee River restoration moving from EARECB to EARFWO:

- Modification to the Lake Kissimmee regulation schedule moving from the current interim operations in ECB23L as seen in **Figure 3.1.1** to the full headwaters revitalization schedule for FWOL as shown in **Figure 3.1.2**.
- Both ECB23L and FWOL include full Kissimmee River Restoration as shown in **Figure 3.1.3**.

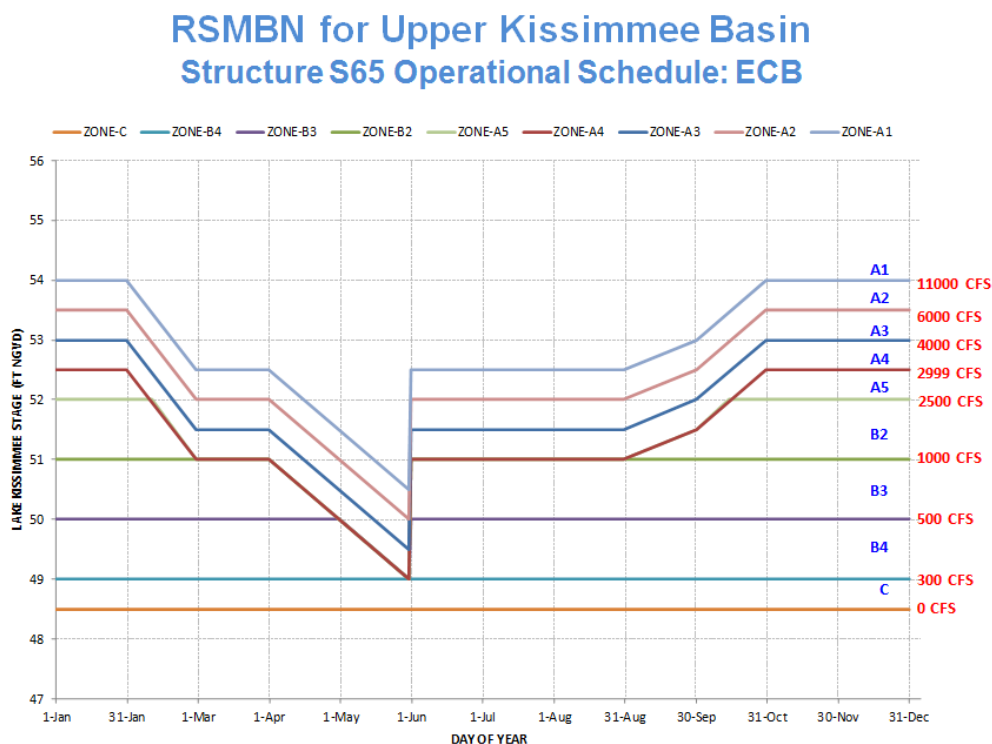


Figure 3.1.1. Lake Kissimmee Regulation Schedule for Releases at S65 for ECB23L.

RSMBN for Upper Kissimmee Basin Structure S65 Operational Schedule: FWO

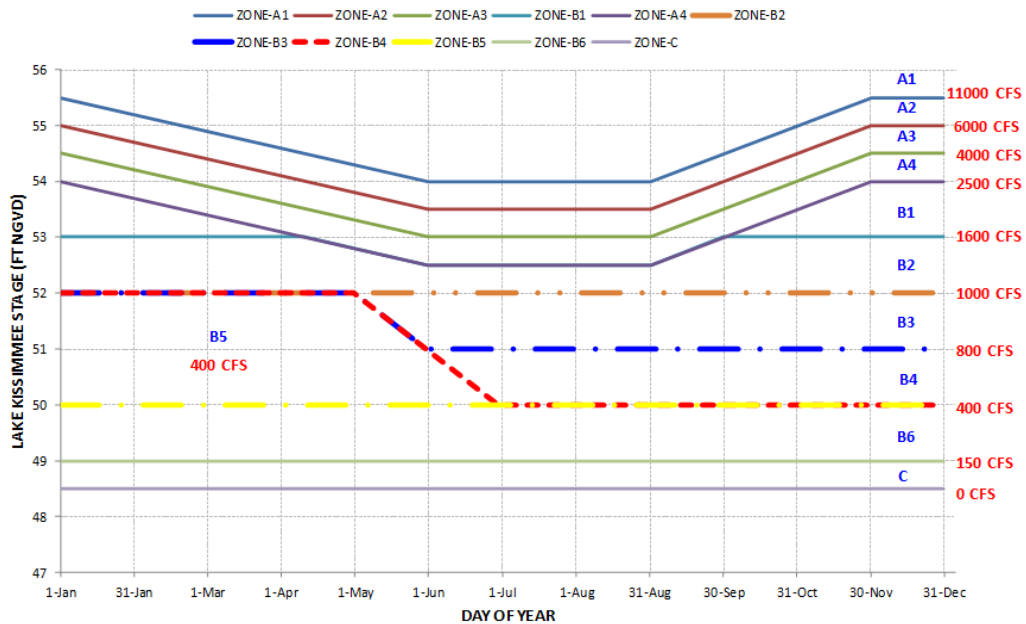


Figure 3.1.2. Lake Kissimmee Regulation Schedule for Releases at S65 for FWOL.

EARECB & EARFWO

- The Lower Kissimmee Basin is partitioned into three major sub-watersheds: Pools A, BCD (Pool BC & Pool D combined into Pool BCD), and E
- Stage-volume and stage-area relationships updated for Pool BCD
- Structure S-65C is removed

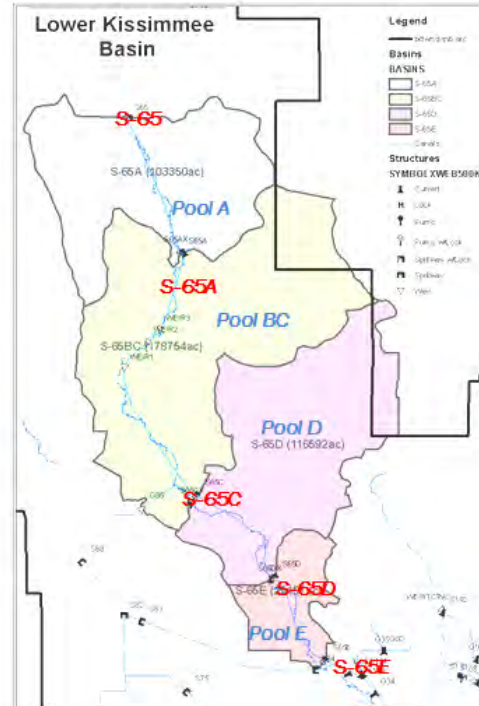


Figure 3.1.3. Kissimmee River Restoration as assumed in both the ECB23L and FWOL Runs.

Indian Prairie Basin Refinements

The LOCAR project consists of a 200,000 acre-ft above ground storage reservoir located in the Indian Prairie basin between canal C-41A and the Kissimmee River/C-38 (Figure 3.1.4).

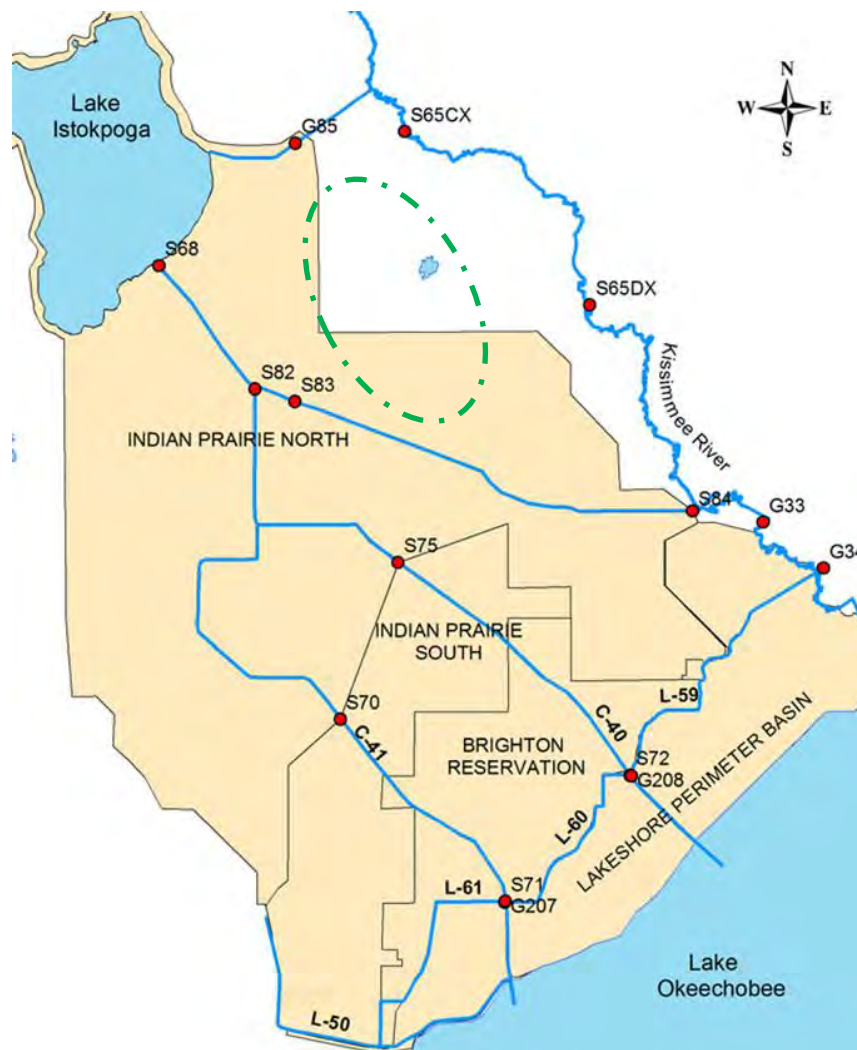


Figure 3.1.4. Project location of 200,000 acre-ft above ground storage reservoir.

To improve the means to evaluate proposed effects of the above ground storage reservoir to flood control, water supply and environmental needs in the Indian Prairie Basin, the RSMBN conceptualization was refined. A schematic of how these waterbodies link with other waterbodies in RSMBN is shown in **Figure 3.1.5**. To convey discharge from the LOCAR reservoir the C-41A canal was divided into a waterbody upstream of structure S83 called “C41A_U” and downstream of structure S83 called “C41A_D”. Runoff from the Istokpoga Basin, via S68, and runoff from Indian Prairie South (IPS) were conveyed to Lake Okeechobee using a simplification of C40, C41 and Lake Shore Canals into a single waterbody called “C40C41LSC”. Lastly, it is important to note pumps G207/G208 are

operated to provide the Seminole Brighton Reservation with deliveries from Lake Okeechobee and were characterized as watermover “G207G208”.

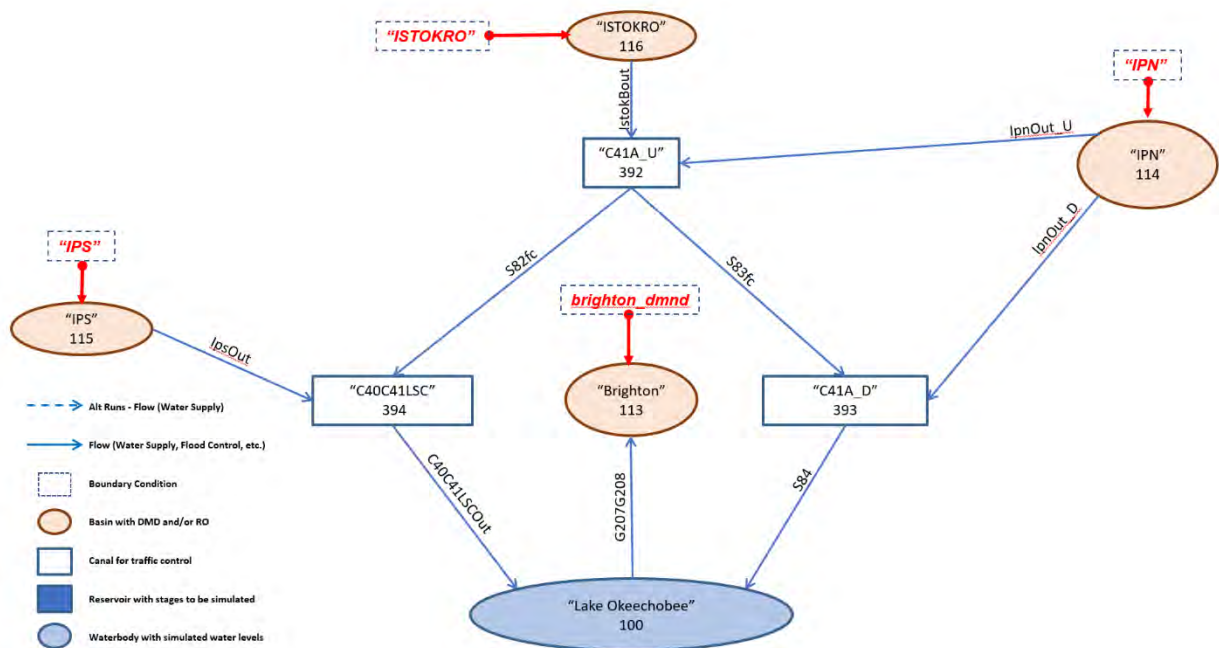


Figure 3.1.5. Schematic Representation of Waterbodies in Indian Prairie Basin for EBC23L and FWOL.

Indian River Lagoon-South

The purpose of the IRL South and Ten Mile Creek projects is to improve surface-water management in the C-23/C-24, C-25, and C-44 basins for habitat improvement in the Saint Lucie River Estuary and southern portions of the Indian River Lagoon. The RSMBN LOCAR modeled configuration is consistent with the LOSOM (IMC, 2021b) for the ECB23L and is consistent with the latest IRL-S design & operations modeling (IMC, 2022a) for the FWOL. Modeling schematics for these features are shown in Figures 3.1.6 (C44 basin only) and 3.1.7 (full IRL). Additional details for the modeled baseline features are consistent with latest CERP Indian River Lagoon – South DDRs that update the authorized 2004 PIR and include:

ECB23L Features:

C44 Reservoir and STA

- Storage capacity: 50,246 acre-feet
- Footprint: 12,125 acres (assumed 9700 effective acres / 80%)
- Inlet: 1060 cfs capacity, modeled as pump; source: C44 Basin
- Inlet: 250 cfs capacity, modeled as pump; source: C23 Basin
- Outlet: 550 cfs capacity, modeled as pump; destination: C44 Basin

- Cannot divert Lake Okeechobee regulatory releases into storage, but runoff diverted is credited as contributing to Lake Okeechobee regulatory targets identified at S80.
- Basin demands can be met by project features.

Ten Mile Creek Reservoir and STA

- Storage capacity: 7078 acre-feet
- Footprint: 820 acres (assumed 656 effective acres / 80%)
- Inlet: 360 cfs capacity, modeled as pump; source: TMC Basin
- Outlet: 200 cfs capacity, modeled as pump; destination: TMC Basin

FWOL Features (Includes ECB23L Plus):

C44 Reservoir and STA

- Water in the C44 reservoir is discharged and allowed to backflow to Lake Okeechobee when Lake stages are below 14.5 ft, consistent with the CEPP TSP operation. Environmental targets for the St Lucie Estuary are met from the reservoir prior to implementing this operation. C44 basin backflow.

C23/24 Reservoir & STA

- Storage capacity: 90,492 acre-feet
- Footprint: North Reservoir = 2,005 acres, South Reservoir = 3,537 acres
- Inlet & Outlet Routing per **Figure 3.1.7**.

C23/C24 STA

- Storage capacity: 3852 acre-feet
- Footprint: 3323 acres (assumed 2568 effective acres / 80%)
- Inlet: 200 cfs capacity, modeled as pump; source: C23/C24 Reservoir
- Outlet: 200 cfs capacity, modeled as pump; destination: TMC Basin

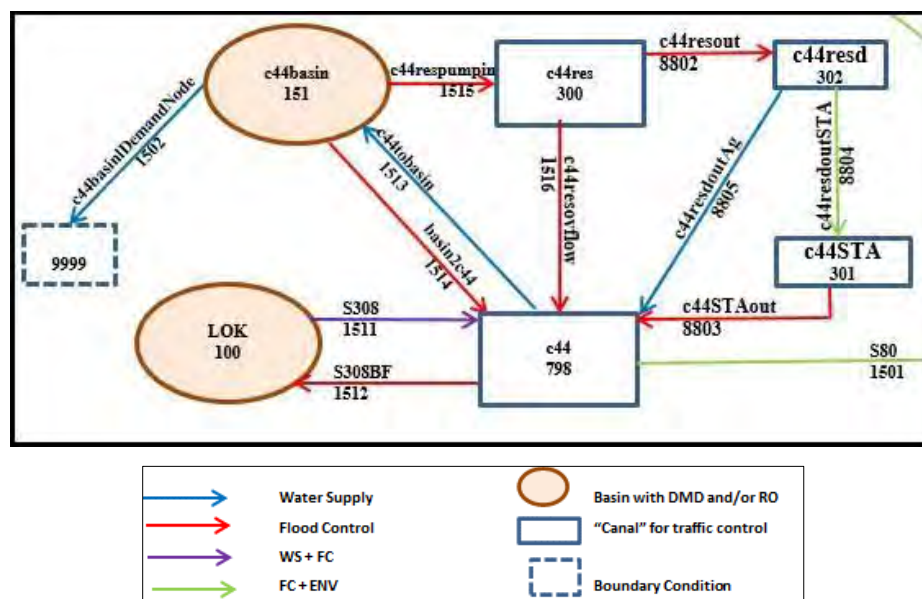


Figure 3.1.6. Schematic Representation of C44 Reservoir & STA Implementation in ECB23L and FWOL

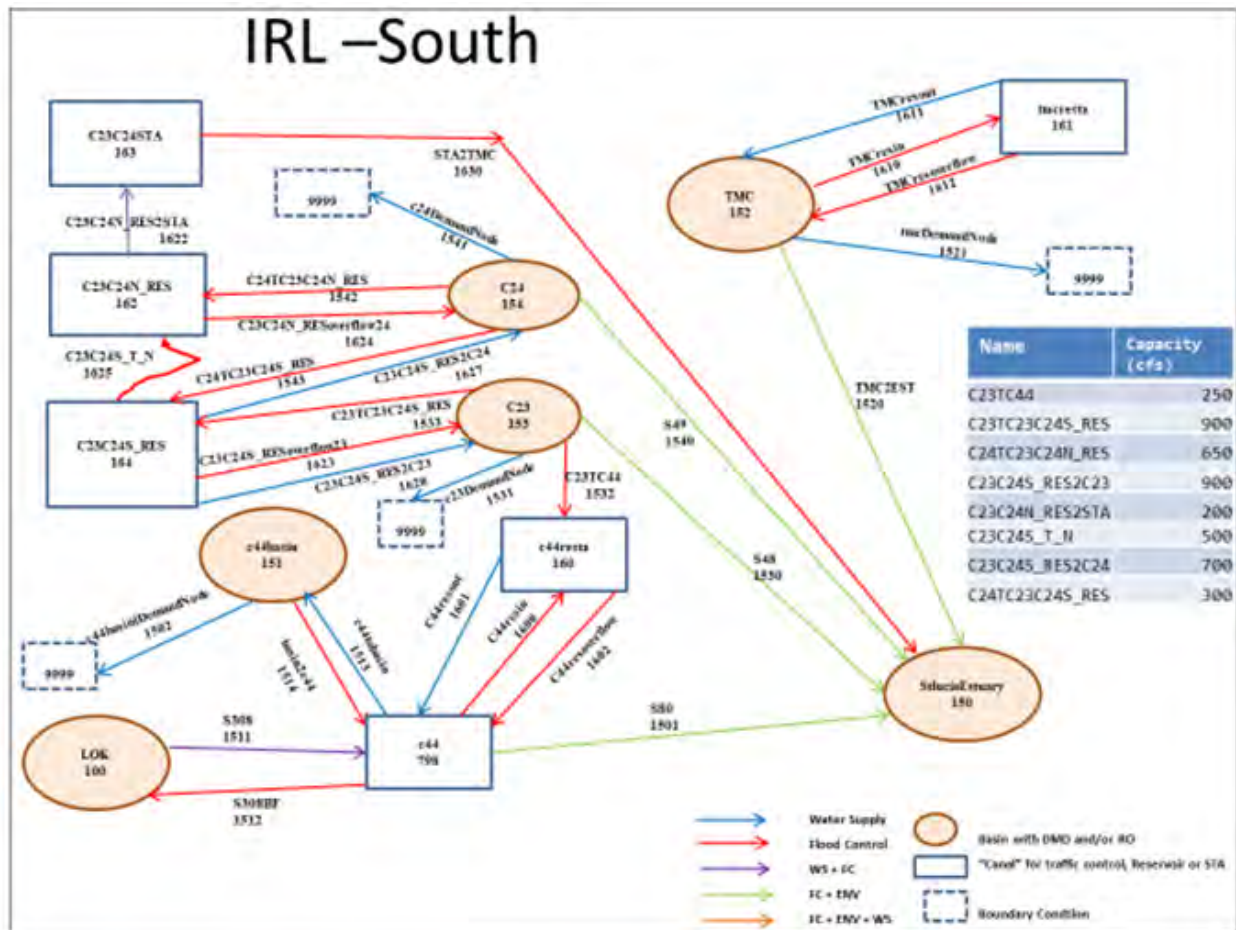


Figure 3.1.7. Schematic Representation of Full IRL-S Implementation in FWOL (note C44ressta implemented like ECB23L with additional internal complexity not shown)

C-43 Phase 1 Reservoir

The purpose of the C-43 Basin Storage Reservoir - Part 1 project is to improve the timing, quantity, and quality of freshwater flows to the Caloosahatchee River estuary. **Figures 3.12 and 3.13** show the model configuration for the RSMBN ECB23L (no reservoir) and FWOL run (with reservoir), respectively:

- Storage capacity: 175,800 acre-feet
- Maximum footprint: 9,379 acres
- Inflow, capacity 1500 cfs, modeled as pump; destination: C43 Reservoir
- Outflow, capacity 1200 cfs modeled as pump; destination: C43 Canal
- Operates based on “dynamic” inflow and release protocols as developed in parallel with LOSOM (IMC, 2021b)
- Can divert Lake Okeechobee regulatory releases into storage.

RSMBN for Caloosahatchee Basin ECB

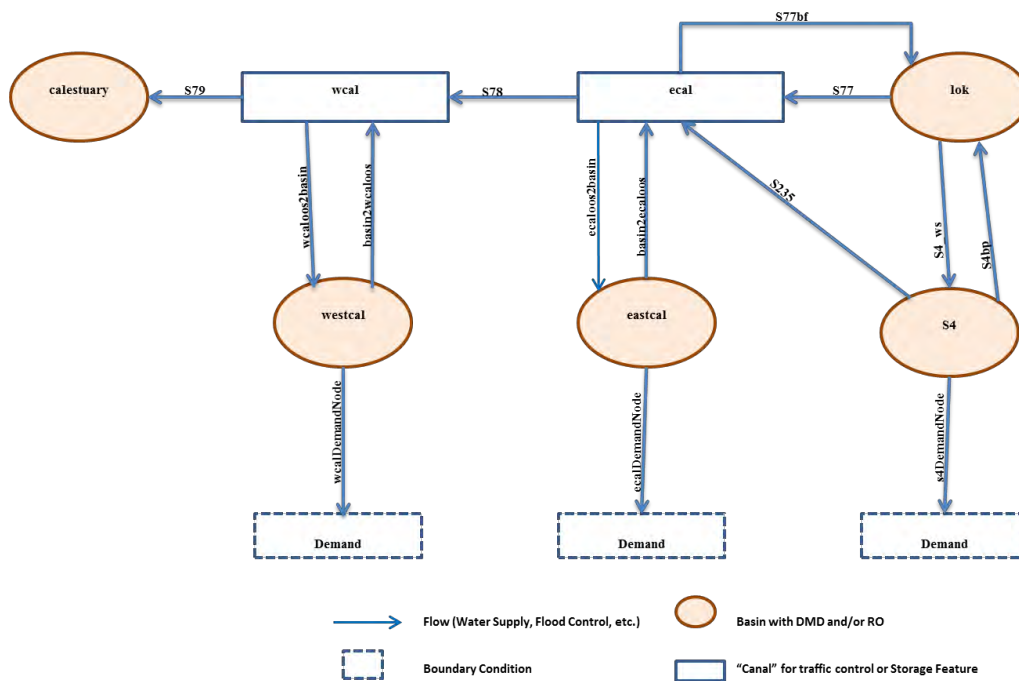


Figure 3.1.8. C43 Basin and Reservoir routing for ECB23L in RSMBN.

RSMBN for Caloosahatchee Basin FWO

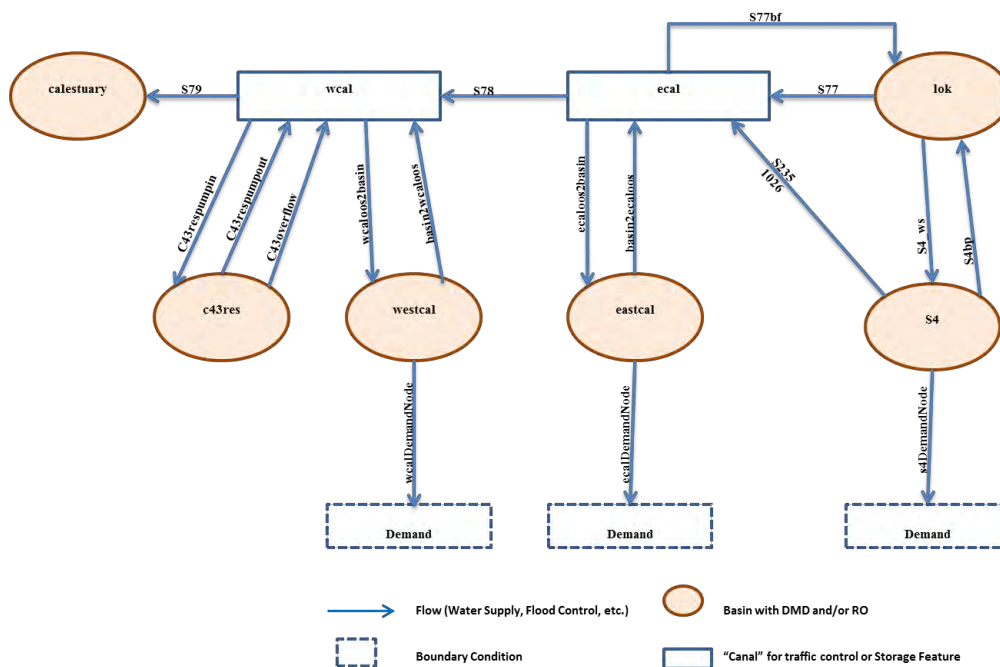


Figure 3.1.9. C43 Basin and Reservoir routing for FWOL in RSMBN.

Lake Okeechobee Operations and EAA Reservoir

Overall, the ECB23L utilizes assumptions that are very similar to the recent LOSOM study and models the preferred alternative LOSOM schedule as its assumption of current Lake Okeechobee Operations, consistent with assumptions in made in the parallel BBSEER CERP planning effort. The as-modeled LOSOM assumptions are shown in **Figure 3.1.10**. In the downstream Everglades Agricultural Area, the ECB23L assumes the presences of existing central flowpath Stormwater Treatment Areas and the A1 Flow Equalization Basin (A1FEB, additional detail on the infrastructure assumed is shown below in describing the FWOL scenario). The CERP A2STA, while under construction is not assumed to be operational in the ECB23L scenario.

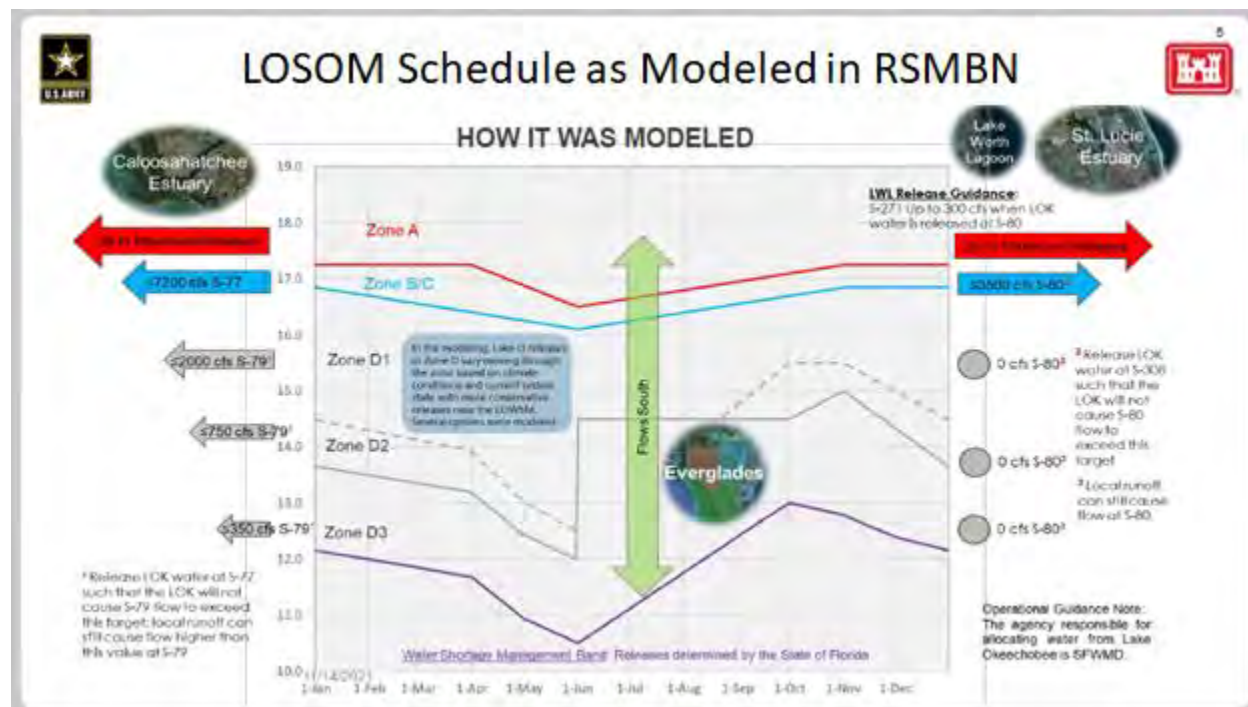


Figure 3.1.10. LOSOM Schedule Simulated in ECB23L

In addition to the ECB23L features, the FWOL scenario assumes the following (see **Figure 3.1.11** for approximate component locations):

A 240 kac-ft storage reservoir located on 10,100 acre effective footprint (A2RES) located north of Holeyland and assumed operations as follows:

- A2 RES inflows are from excess EAA basin runoff above the established inflow targets at STA-3/4, STA-2N, and STA-2S, and from LOK flood releases south (up to ~ 4ft buffer depth from full level to allow attenuation of peak EAA runoff events).
- Work in conjunction with the A2STA – a treatment facility having an effective area of 6,550 acre, receiving outflow from the A2RES and discharging to lower Miami Canal.

- A2RES outflows are used to help meet established inflow targets (as estimated using the Dynamic Model for Stormwater Treatment Areas) at A1FEB, STA-3/4, STA-2N, STA-2S and A2STA if EAA basin runoff and LOK regulatory discharge are not sufficient.
- 0.5 ft minimum depth below which no releases are allowed
- 23.5 ft maximum depth above which inflows are discontinued
- Inflows at the reservoir inflow pump station are assumed to convey up to 3,000 cfs from the Miami canal and 1,500 cfs from the NNR canal (combined basin runoff and Lake O water); inflow to the EAA reservoir can also be made from the existing G370 and G372 pump stations up to a 6.0 ft depth.
- Supplemental irrigation demands in the Miami and NNR/Hillsboro basins can be met from the reservoir when reservoir depths exceed 8.2 feet.

A 15,853-acre Flow Equalization Basin (A1 FEB) located north of STA-3/4 with assumed operations as follows:

- FEB inflows are from the A2 RES and are consistent with established inflow targets (as estimated using the Dynamic Model for Stormwater Treatment Areas). FEB inflows are limited to 500 cfs when depths are above 2.5 ft.
- FEB outflows are used to help meet established inflow targets (as estimated using the Dynamic Model for Stormwater Treatment Areas) at STA-3/4, STA-2N, and STA-2S if EAA basin runoff and LOK regulatory discharge are not sufficient.
- 0.5 ft minimum depth below which no releases are allowed
- 3.8 ft maximum depth above which inflows are discontinued
- Assumed inlet structure of 1,500 cfs capacity from A2 RES for modeling purposes.



Figure 3.1.11. EAA Reservoir, A1FEB and A2STA in FWOL

The operations of the assumed EAA reservoir and FEB features in the future condition are consistent with the as-authorized CERP EAA reservoir planning documents. These features are integrated with the regional objectives by including operational modifications to the Lake Okeechobee regulation schedule as follows:

- Lake Okeechobee regulatory releases to the south are made when the Lake is in or above the baseflow zone of the LORS08 schedule and when criteria as identified in **Figure 3.1.12** are satisfied.
- In order to promote opportunity for Lake discharges to the south, release criteria from the Northern Estuaries are also modified to result in lower overall discharges.
- Collectively these operations are known as “LORS+”, reflecting their foundational operational basis in the previously authorized Lake Okeechobee Regulation Schedule 2008 (LORS08) protocols.

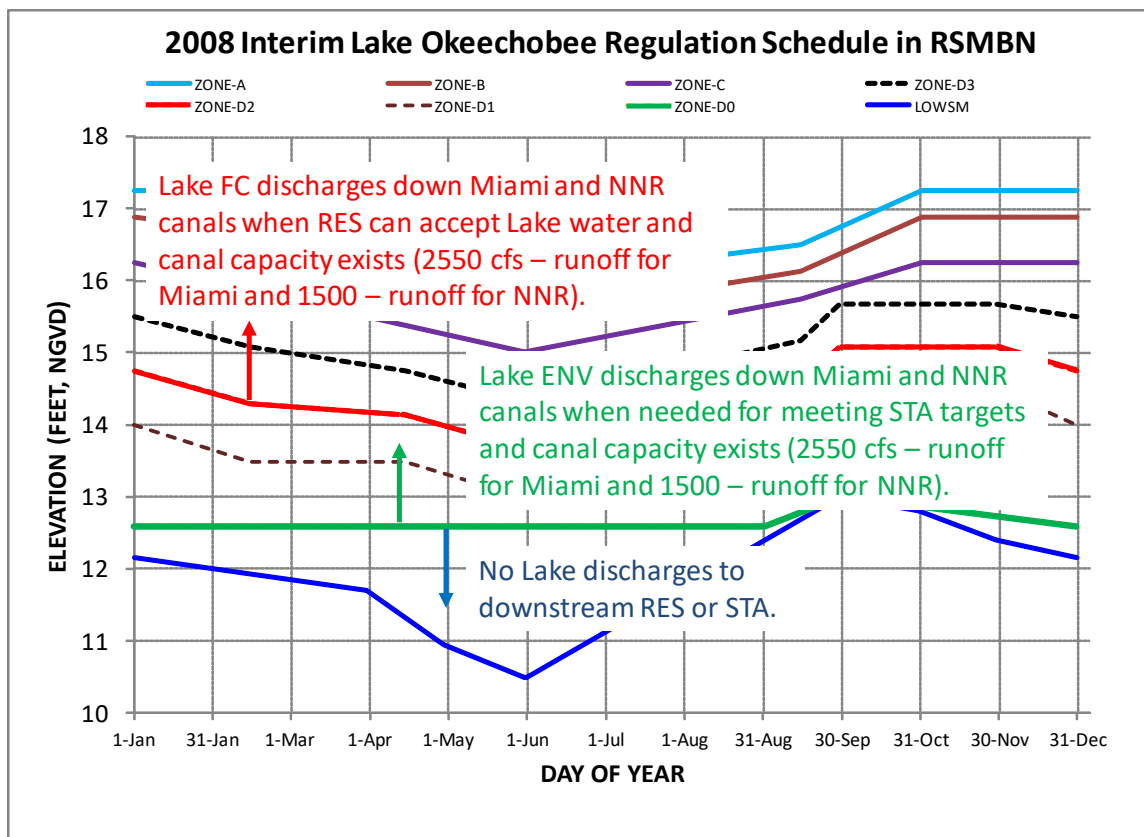


Figure 3.1.12. LORS08-Based Regulation Schedule in FWOL

Other 1st and 2nd Generation CERP and Foundation Projects

A number of other projects in the South Florida area are assumed to be implemented in the period of time between the existing (ECB23L) and future (FWOL) conditions and are fully cataloged in the model assumption tables. Given that these features are not within the study area, these features are not detailed in this MDR although they are included in the modeling for completeness. Given their remote proximity to proposed LOCAR plan features combined with the assumption that LOCAR will maintain flows south relative to the FWOL baseline, these components are not likely to significantly affect the evaluation of LOCAR.

3.2 Alternatives Model Set Up

The Future with Project Alternatives (LCR1, LCR2, LCR3) were built in the RSMBN starting from the FWOL. Each alternative contained the unique storage & conveyance features per each alternative as previously illustrated. Initially, a GIS exercise was performed to identify the as-modeled details which are summarized in **Table 3.2.1** and **Figures 3.2.1** through **3.2.3**. As previously identified, although each scenario simulates 200,000 acre-ft of storage, each has a different spatial extent and reservoir normal full stage level (NFSL), resulting in different reservoir and basin input details in RSMBN. Once

the reservoir features were fully defined, a simplified form of the conveyance infrastructure (still pending detailed design) was implemented into the model. The schematics in **Figures 3.2.4** and **3.2.5** show the routing of the LOCAR reservoir in the alternatives as modeled. Inflow and outflow capacities were assumed to be 1,500 cfs.

Table 3.2.1. Reservoir Configurations as Modeled.

Alternative	East-West/South Reservoir Area (acre)	East-West/South Reservoir NFSL (ft, NVGD29)	North Reservoir Area (acre)	North Reservoir NFSL (ft, NVGD29)
LCR1	11,875	51.80	n/a	n/a
LCR2	11,928	44.35	6,792	57.92
LCR3	6,825	50.24	6,884	61.32



Figure 3.2.1. LOCAR Alternative 1 (LCR1) Reservoir Siting

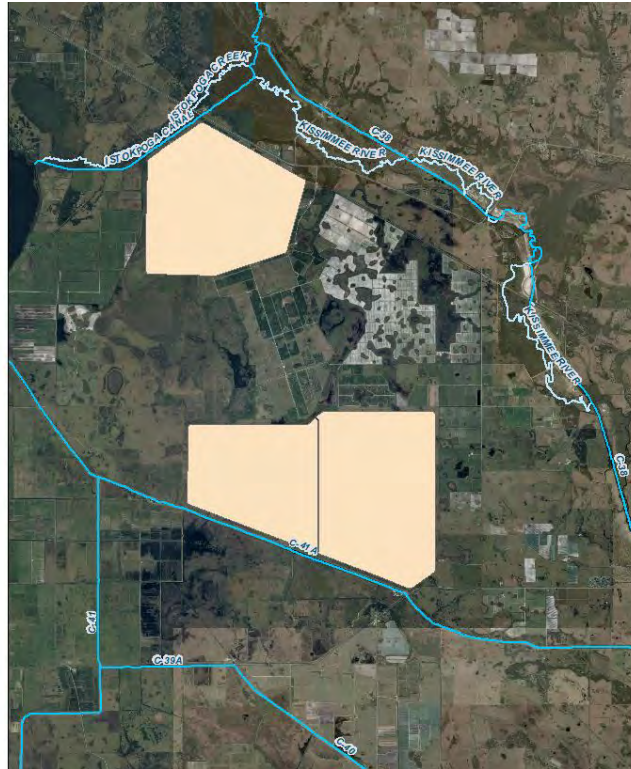


Figure 3.2.2. LOCAR Alternative 2 (LCR2) Reservoir Siting

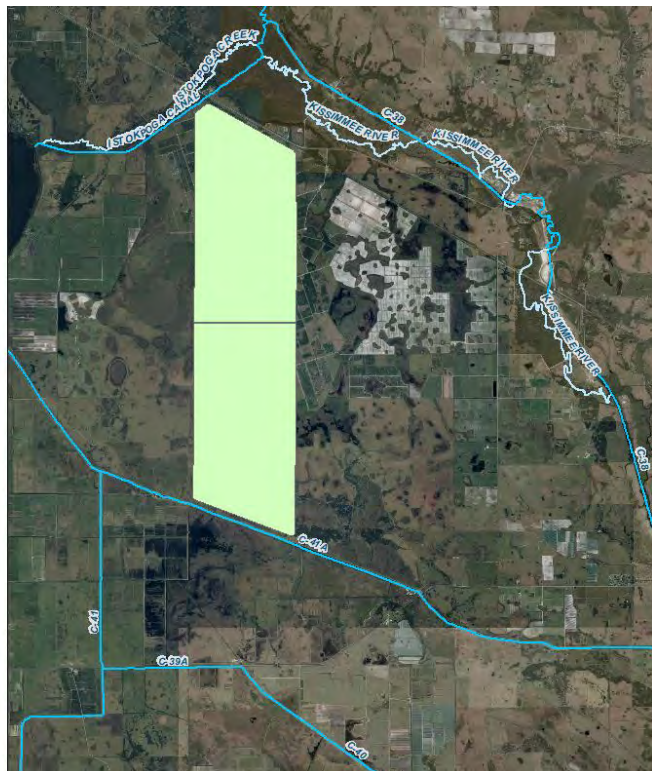


Figure 3.2.3. LOCAR Alternative 3 (LCR3) Reservoir Siting

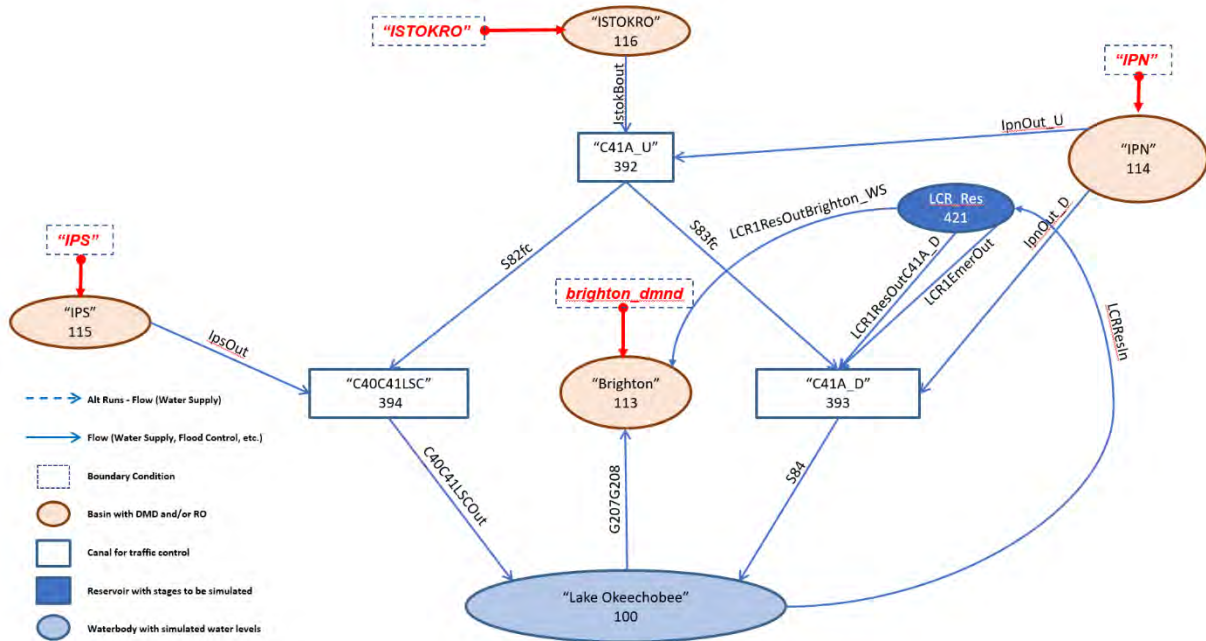


Figure 3.2.4. Schematic representation of waterbodies including the LOCAR reservoir alternative LCR1 in Indian Prairie Basin.

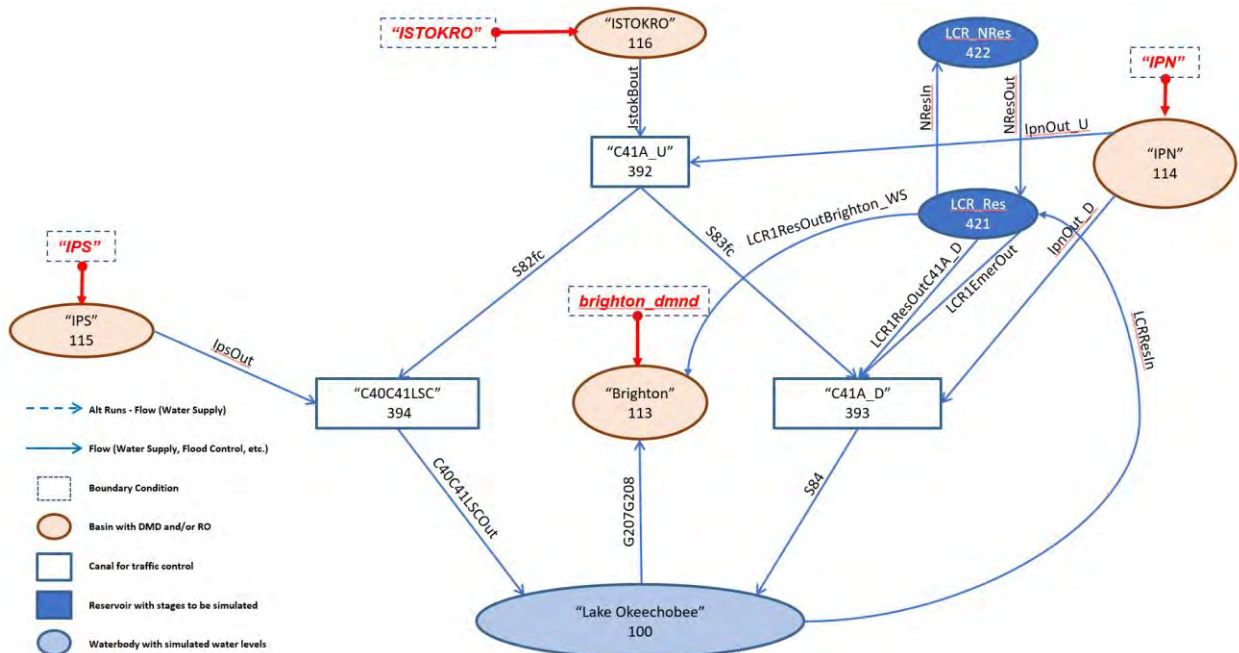


Figure 3.2.5. Schematic representation of waterbodies including the LOCAR reservoir alternative LCR2 and LCR3 in Indian Prairie Basin.

To integrate the operation of the LOCAR reservoir into the regional water management protocols, a set of operational changes were made to Lake Okeechobee (as conceptually considered in CERP components A & F) to allow for diversion to and recovery from storage as well as to take advantage of this storage by reducing northern estuary discharges. First, the Lake Okeechobee schedule was returned to the LOSOM protocols, reflecting the preferred operational outcome of the exhaustive public planning process that identified LOSOM as the replacement to the LORS08 schedule (which was the basis of the FWOL operations). Next, a batch process like that performed during the development of LOSOM (**IMC, 2021a & b**) was performed to ensure that schedule parameters were identified that maximized the intended performance of the LOCAR plan. All alternatives endeavored to release flow south consistent with the FWOL and to the maximum extent practicable improve system performance for Lake Okeechobee & the Northern Estuary ecosystems as well as for water supply users. As such, a “LOSOM-like” schedule was explored in the parameter space (~ total 10,000 runs) with the following resulting changes applied to LCR1, LCR2 and LCR3:

- Addition of LOCAR storage diversion & recovery lines to the Lake schedule; when above the diversion line water is sent to the LOCAR reservoir from Lake Okeechobee, subject to conveyance & storage capacity and when below the recovery line, water is sent back from LOCAR storage to Lake Okeechobee.
- Lowered Zone B/C Line by 0.5 ft.
- Reduced Zone D S79 discharges (parameters identified through model optimization – Zone D1 releases reduced from 1,200 cfs to 750 cfs; Zone D2 releases reduced from 750 cfs to 550 cfs and conservation mode releases reduced to 50 cfs)
- EAA Reservoir discharge line revised to maintain flows south.
- Water can be released to the C41 / C41A canals and used for water supply if the LOCAR reservoir is $\geq 33\%$ full.

The schedule line changes listed above are displayed in **Figure 3.2.6**, with LOSOM shown in blue, LOCAR-related updates to LOSOM shown in yellow and the revised EAA reservoir line shown in red.

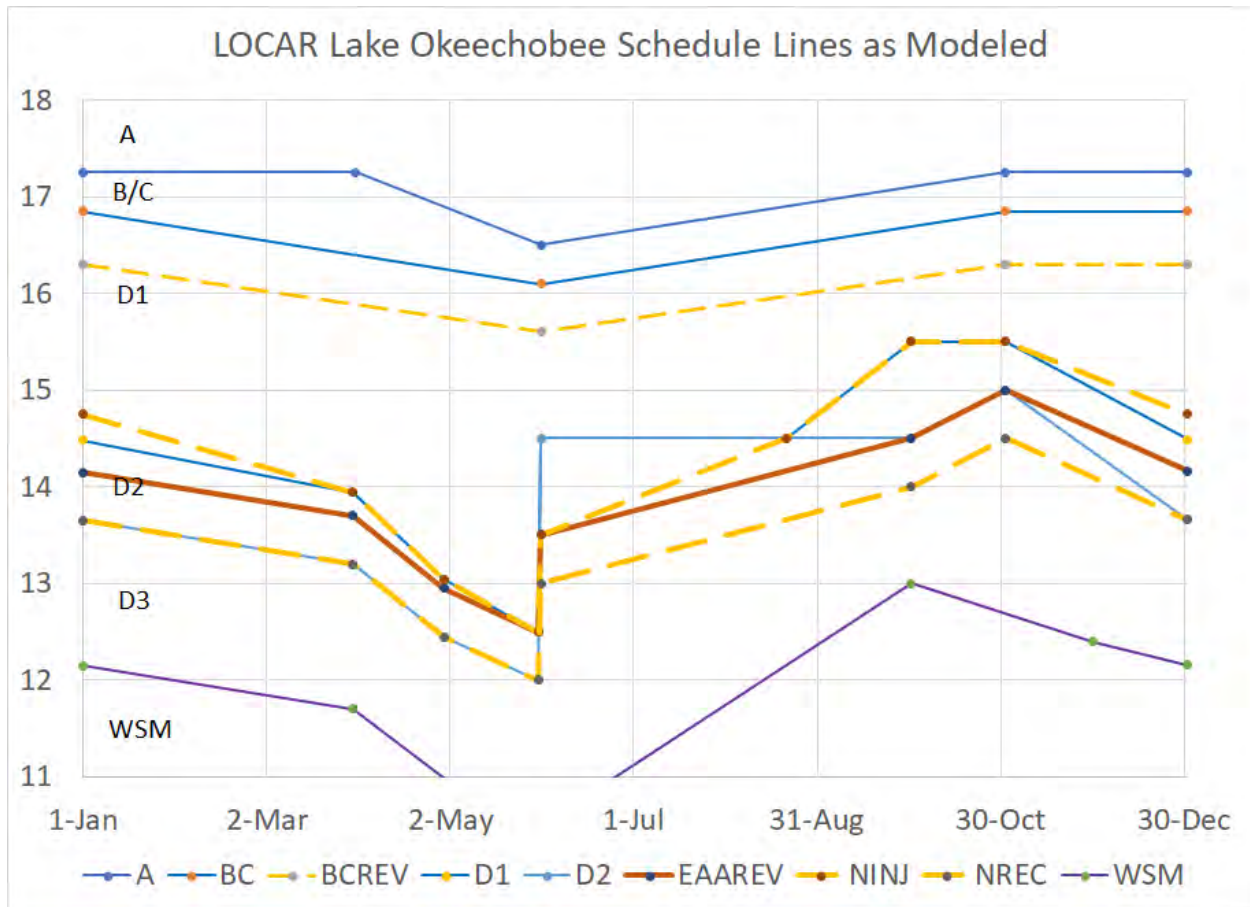


Figure 3.2.6. Lake Okeechobee Operational Lines for Alternatives LCR1, LCR2, LCR3

4.0 Results

The LOCAR project identified the LCR1 scenario as the Tentatively Selected Plan (TSP). Final LOCAR modeling products will be uploaded to the Statewide Model Management System (SMMS) once the project has been finalized. SMMS is a geographic information system (GIS) based application that includes model input data, select model output data, source code/executable files and documentation. LOCAR Project modeling products in SMMS will be available by selecting the LOCAR project from the “project” drop down box or by selecting the LOCAR study area at:

<https://apps.sfwmd.gov/smmsviewer/>

While the modeling products will be archived in the above systems, the table below lists more specific information including model version & inputs used. Version numbers and “svnroot” paths refer to a model version control system found on the SFWMD network that is not generally accessible, hence the need to upload into SMMS.

Version information and model file locations

LOCAR RSMBN ECB23L 05122023	RSM 4.0.15
Input: ... https://whqsvn02p.sfwmd.gov/websvn/browse/svnroot/trunk/rsm_imp/LOCAR/Models/RSMBN/Baselines/ECB22	
Output: .../nw/hesm_nas/projects/LOCAR/Models/RSMBN/Baselines/ECB23L/output_052123_xml19063	
LOCAR RSMBN FWO 05122023	RSM 4.0.15
Input: ... https://whqsvn02p.sfwmd.gov/websvn/browse/svnroot/trunk/rsm_imp/LOCAR/Models/RSMBN/Baselines/FWOL	
Output: .../nw/hesm_nas/projects/LOCAR/Models/RSMBN/Baselines/FWOL/output_052123_xml19063	
LOCAR RSMBN LCR1 05232023	RSM 4.0.15
Input: ... https://whqsvn02p.sfwmd.gov/websvn/browse/svnroot/trunk/rsm_imp/LOCAR/Models/RSMBN/Alternatives/LCR1	
Output: .../nw/hesm_nas/projects/LOCAR/Models/RSMBN/Alternatives/LCR1/output_052323_xml19069	
LOCAR RSMBN LCR2 05232023	RSM 4.0.15
Input: ... https://whqsvn02p.sfwmd.gov/websvn/browse/svnroot/trunk/rsm_imp/LOCAR/Models/RSMBN/Alternatives/LCR2	
Output: .../nw/hesm_nas/projects/LOCAR/Models/RSMBN/ Alternatives/LCR2/output_052323_xml19069	
LOCAR RSMBN LCR3 05232023	RSM 4.0.15
Input: ... https://whqsvn02p.sfwmd.gov/websvn/browse/svnroot/trunk/rsm_imp/LOCAR/Models/RSMBN/Alternatives/LCR3	
Output: .../nw/hesm_nas/projects/LOCAR/Models/RSMBN/ Alternatives/LCR3/output_052323_xml19069	

Review of Local and Regional-Level Results

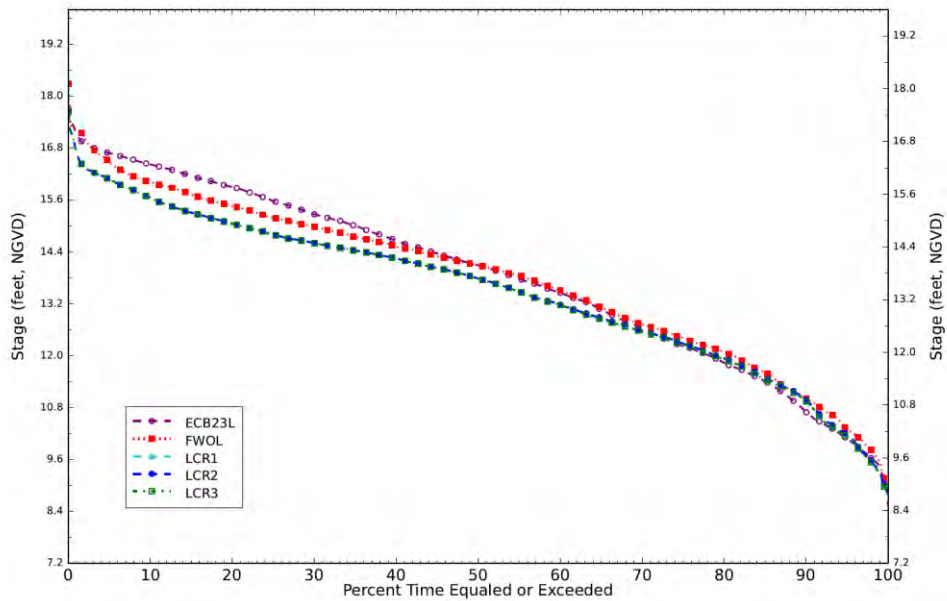
The RSMBN modeling scenarios were reviewed from the perspective of ensuring that localized effects of project implementations were observed as expected and that regional performance was considered reasonable. Specific checks on RSM outputs included the following:

- Lake Okeechobee performance relative to baselines are shown in **Figures 4.1** and **4.2**. The figures show Lake Okeechobee stage duration and stage envelope upper/lower penalties. In **Figure 4.1**, all alternatives show a lower stage in Lake Okeechobee 65% percent of time or less. In **Figure 4.2**, the alternatives show a reduced high stage penalty when compared to ECB23L and FWOL. The alternatives show a reduced lower stage penalty when compared to ECB23L. However, the lower penalty shows an increase when compared to FWOL which is due to Lake Okeechobee's operational intent (e.g. LORS08) and ECB23L/alternatives are based on LOSOM's PA25.
- Mean annual food control releases from Lake Okeechobee are shown in **Figure 4.3**. The effects of the different flood control releases on Lake Okeechobee stages can be seen when compared with stage duration curves in **Figure 4.1**. The figure also shows that the volume of flow south is maintained in the LCR alternatives relative to the FWOL, thereby honoring the project assumption/constraint that LOCAR will not impact the benefits of the EAA reservoir project or reduce flows to the Everglades. This is further confirmed by the STA flows south as shown in **Table 4.1**; in fact, the LOCAR alternatives show some potential to increase flow south later into the dry season as an additional benefit of storage.
- For the northern estuaries, Lake triggered events relative to baselines are shown in **Figures 4.4** and **4.5**. The figures illustrate low, optimum, high, and damaging flow events. In addition, the high and damaging events are further discretized into Lake Okeechobee and Basin events. The differences in performance reflect the operation intent and perform as expected. The effects of both the LOCAR project and the storage added as part of the baseline scenarios is evident in the performance measure.
- LOSA and Tribal water supply relative to baselines are shown in **Figures 4.6**, **4.7** and **4.8**. **Figure 4.6** illustrates the largest events for the Lake Okeechobee Service Area (LOSA) demand cutback volumes. The differences in demand cutback volumes and shortages reflect difference in plans and perform as expected, with improvements clearly illustrated relative to the current condition.
- **Figures 4.7** and **4.8** show annual average irrigation supplies and shortages for the Seminole Tribe at the Brighton and Big Cypress Reservations. Not only are improvements in cutbacks relative to the current condition evident, but the local supply of water from the LOCAR reservoir to the Brighton Reservation illustrates a significant availability of local supplemental supply from the project feature.
- As can be seen in all these figures, the three LCR1, LCR2 and LCR3 alternatives all perform similarly as would be expected given that they all implement the same storage volume (~200 kacft) and are operated for the same objective of managing Lake Okeechobee stage.

- It is noted that in some figures, the changes from the existing condition to the future without project condition to the LOCAR alternatives does not represent a continuous trend in performance. This is due to the presence of the LORS-based schedule utilized in the future without project condition consistent with the current draft project operating manual for the EAA Reservoir. It is expected that future implementations of Lake Okeechobee regulation schedules will not return to LORS-like protocols, but rather would continue to evolve the LOSOM-like operational mindset. To this end, a comparison set was developed to illustrate how the addition of storage features would help to improve a system using consistent LOSOM-like protocols and these results are summarized in **Appendix B**.
- Upon selection of the TSP, an additional sensitivity test was performed on the LCR1 scenario to explore increasing the inflow capacity to the LOCAR reservoir. These results are summarized in **Appendix C**.

In summary, the modeled scenarios provided to the LOCAR project team are deemed to adequately represent the intended planning conditions and provide a reasonable basis of comparison for the necessary evaluations required to draft the project report.

Stage Duration Curves for Lake Okeechobee

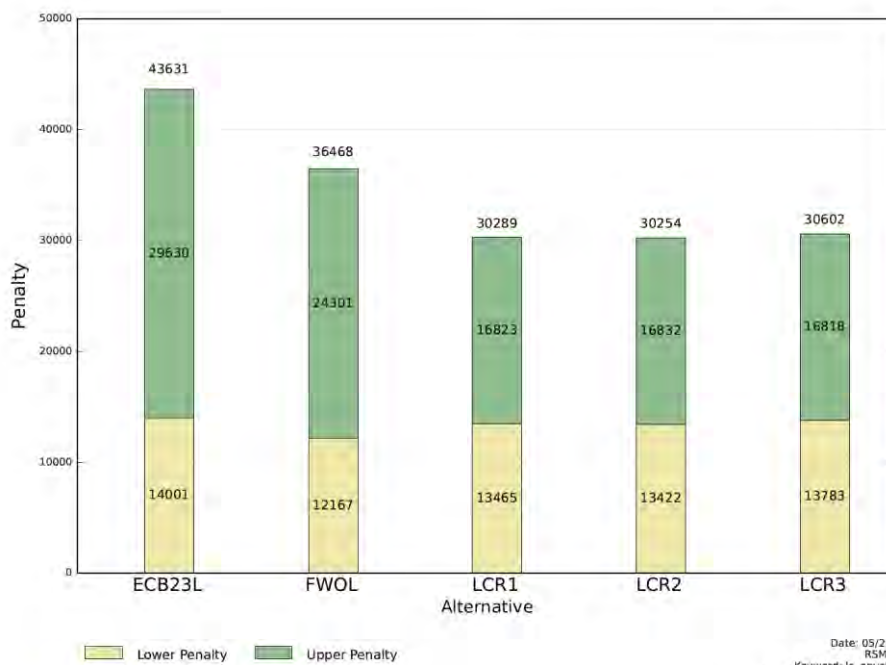


RSMBN P.O.S. 1965-2016

Date: 05/23/23 10:11:55
 RSM Version 5816
 Keyword: lo_duration
 Reference: rsmib_2016_ws271_lcr.xml

Figure 4.1. Lake Okeechobee Stage Duration Curves Comparing Baselines and Alternatives.

Lake Okeechobee Envelope Penalty Scores - All Years



Date: 05/23/23 10:11:59
 RSM Version 5816
 Keyword: lo_envelope_score_v2
 Reference: rsmib_2016_ws271_lcr.xml

Figure 4.2. Lake Okeechobee Stage Envelope Upper and Lower Penalties Comparing Baselines and Alternatives.

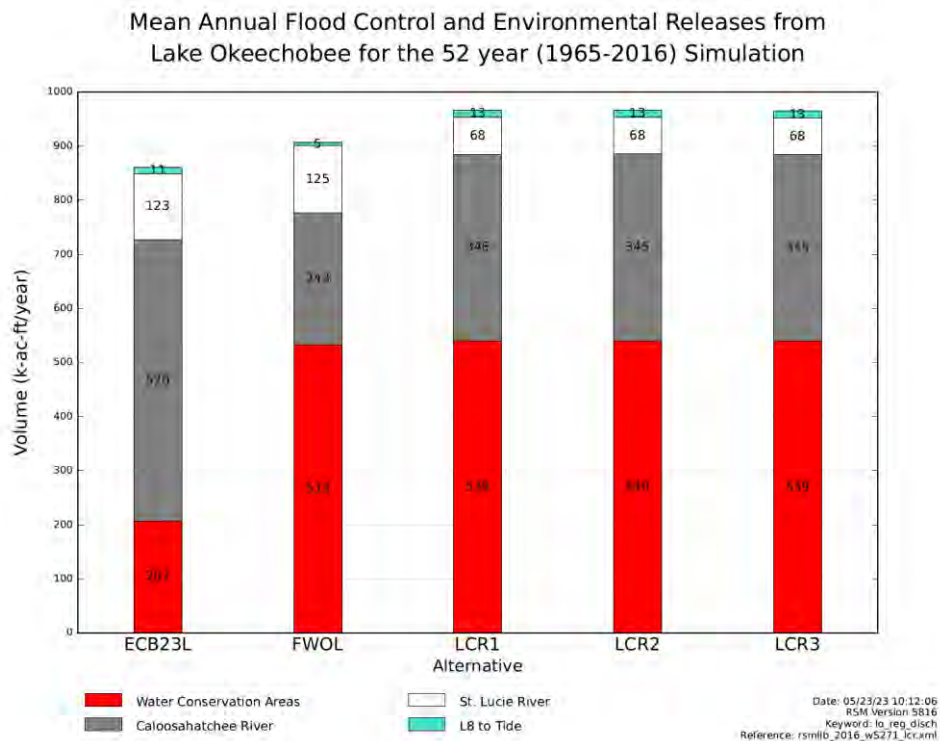


Figure 4.3. Mean Annual Flood Control Releases from Lake Okeechobee (1965-2016).

Table 4.1. RMSBN Flow South Report

Period of Record 1965/1/1 2016/12/31

All units are average annual flow k-ac-ft/yr.

Index_CFP = Index for Central Flowpath flows to Greater Everglades.

LOK flows south wet season: June 1 to October 31 (5 months)

LOK flows south early dry season: November 1 to February 28/29 (4 months)

LOK flows south late dry season: March 1 to May 31 (3 months)

Simulation	LOK_South	STA2	STA3/4	Index_CFP	LOK_South_Wet	LOK_South_Early_Dry	LOK_South_Late_Dry
ECB23L	206.56	472.72	388.75	22	73.68	76.99	55.89
FWOL	533.03	567.86	457.36	7	94.70	278.31	160.02
LCR1	539.14	565.81	454.52	7	85.46	272.18	181.50
LCR2	540.09	566.21	454.95	7	85.91	272.29	181.89
LCR3	539.42	565.83	454.51	7	85.46	271.71	182.25

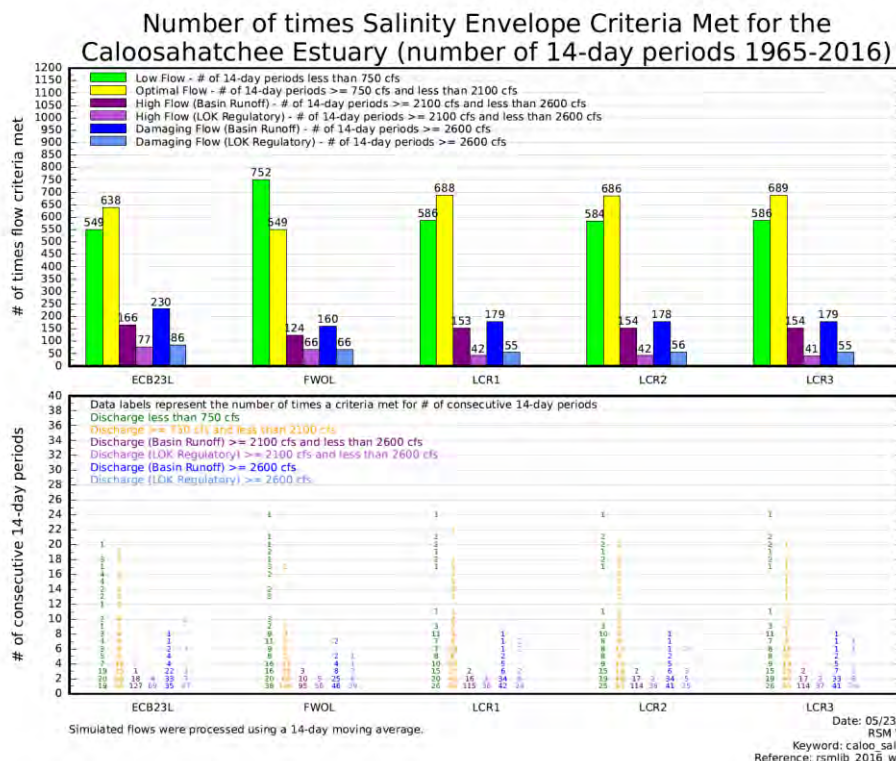


Figure 4.4. Salinity Envelope Criteria for the Caloosahatchee Estuary.

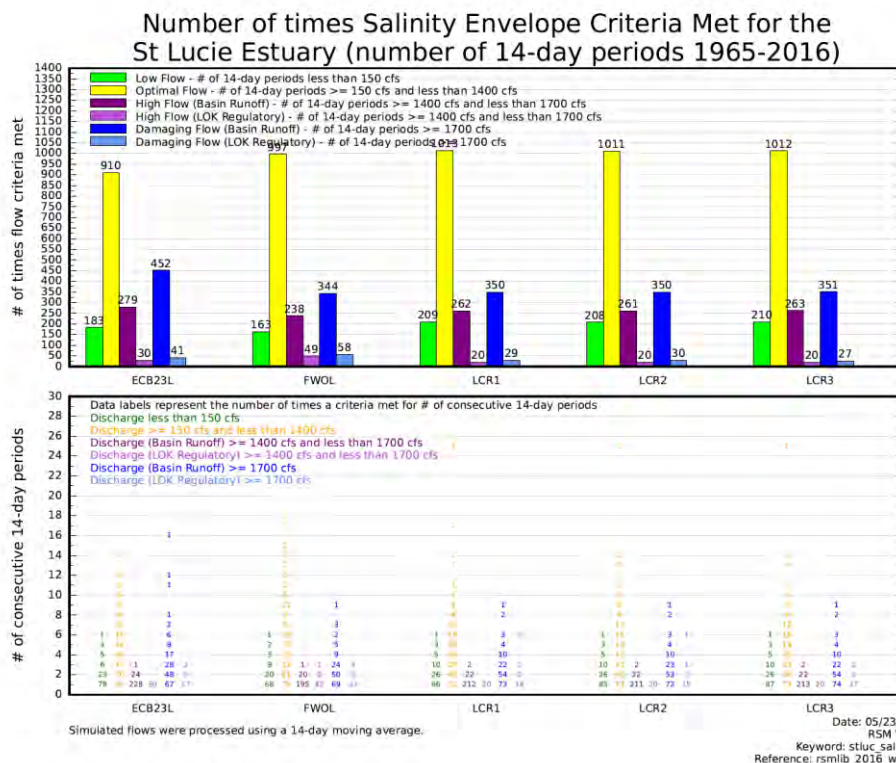


Figure 4.5. Salinity Envelope Criteria for the St. Lucie Estuary.

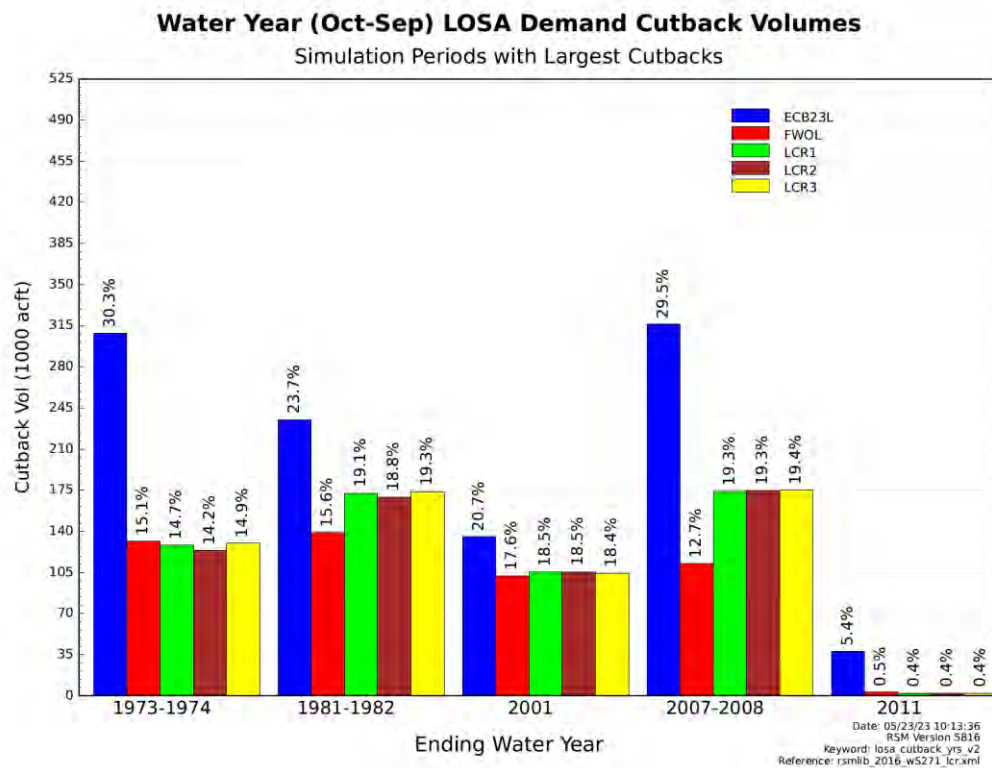


Figure 4.6. LOSA Demand Cutback Volumes for Drought Events.

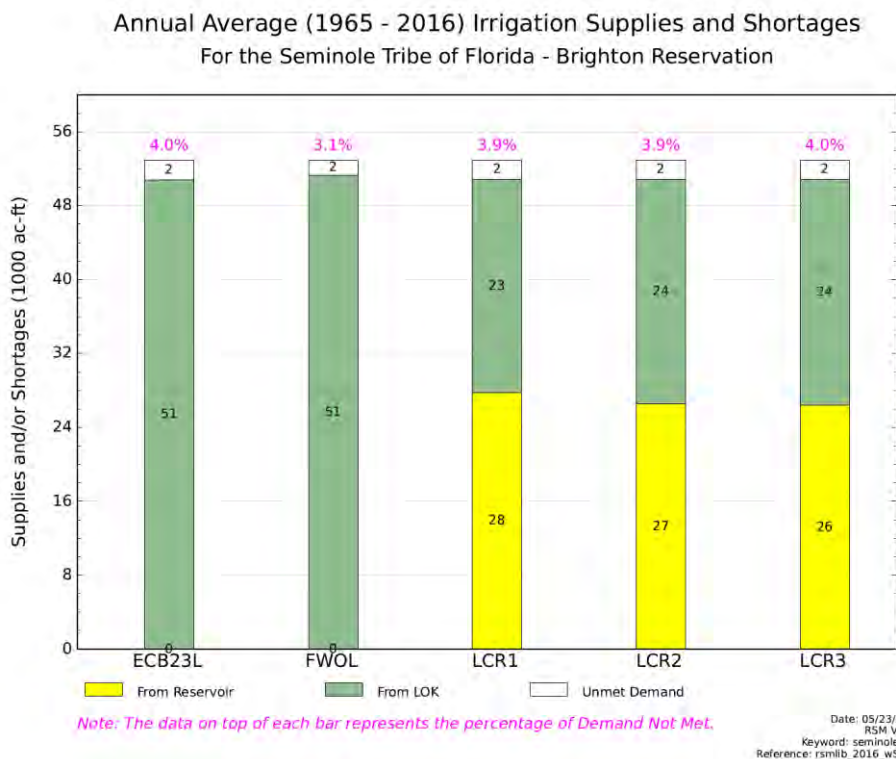


Figure 4.7. Annual Average Irrigation Supplies for the Seminole Brighton Reservation.

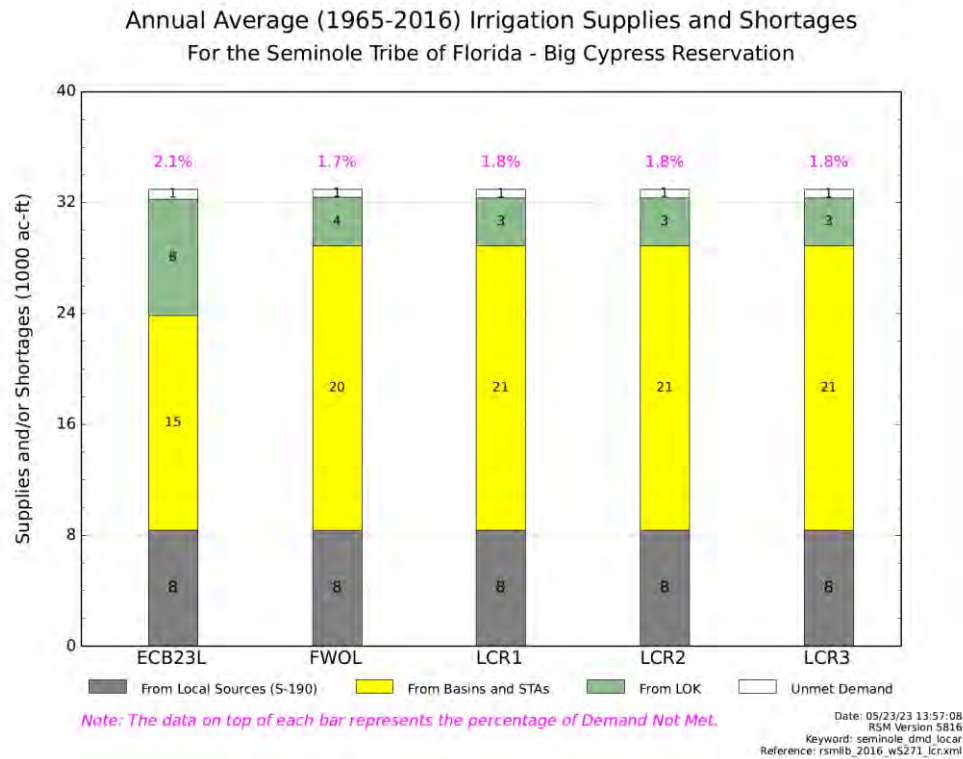


Figure 4.8. Annual Average Irrigation Supplies for the Seminole Big Cypress Reservation.

References

- Interagency Modeling Center (IMC), 2019b. MSR 5485 Lake Okeechobee Watershed Restoration Project (LOWRP) Recommended Plan (ALT1BWR) Model Documentation Report. Modeling Section, H&H Bureau, West Palm Beach, FL. February 28, 2019.
- IMC, 2019b. Indian River Lagoon South - Model Documentation Report. IMC. Modeling Section, H&H Bureau, West Palm Beach, FL. September 24, 2019.
- IMC, 2021a. Lake Okeechobee System Operating Manual (LOSOM): Sensitivity Analysis and Conceptual Schedule Testing. IMC. Modeling Section, H&H Bureau, West Palm Beach, FL. December 13, 2020.
- IMC, 2021b. LOSOM: Balanced Array and Selected Plan. IMC. Modeling Section, H&H Bureau, West Palm Beach, FL. December 13, 2020.
- IMC, 2022a. Indian River Lagoon South -C-23/C24 Reservoir/STA Model Documentation Report. IMC. Modeling Section, H&H Bureau, West Palm Beach, FL. March 9, 2022.
- IMC, 2022b. BBSEER Existing Condition Baseline and Future Without Project Baseline. Presentation to Biscayne Bay and Southeastern Everglades Ecosystem Restoration (BBSEER) Project Delivery Team. IMC. Modeling Section, H&H Bureau, West Palm Beach, FL. Presentation to June 30, 2022.
- South Florida Water Management District (SFWMD), 2005a, Regional Simulation Model - Theory Manual. South Florida Water Management District, West Palm Beach, FL.
- SFWMD, 2005b, Regional Simulation Model - Hydrologic Simulation Engine (HSE) User Manual. South Florida Water Management District, West Palm Beach, FL.
- SFWMD, 2007. South Florida Environmental Report. Chapter 11: Kissimmee River Restoration and Upper Basin Initiatives. West Palm Beach, FL:
- SFWMD & IMC. 2014a. Model Documentation Report: Central Everglades Planning Project (CEPP) Baseline Runs MDR. USACE DASR Project 51-Central Everglades Planning. MSR 368 Model_Documentation. Hydrologic & Environmental Systems Modeling Section, Water Supply Bureau, West Palm Beach, FL. February 14, 2014, 98 pp.
- SFWMD & IMC. 2014b. Model Documentation Report: Central Everglades Planning Project (CEPP) Final Array of Alternatives MDR. USACE DASR Project 51-Central Everglades Planning. MSR 368 Model_Documentation. Hydrologic & Environmental Systems Modeling Section, Water Supply Bureau, West Palm Beach, FL. February 14, 2014, 62 pp.

- SFWMD, 2018a. Model Documentation Report: Everglades Agricultural Area Storage Reservoir Project (EAASR) Baseline and Screening Runs MDR. Modeling Section, H&H Bureau, West Palm Beach, FL. January 30, 2018, 72 pp.
- SFWMD, 2018b. Model Documentation Report: Everglades Agricultural Area Storage Reservoir Project (EAASR) Final Array of Alternatives MDR. Modeling Section, H&H Bureau, West Palm Beach, FL. January 30, 2018, 56 pp.
- SFWMD, 2021. Regional Simulation Model for BasiNs (RSMBN) Implementation Manual. SFWMD, West Palm Beach, FL.
- SFWMD, 2022. Regional Simulation Model - Hydrologic Simulation Engine (HSE) User Guide. South Florida Water Management District, West Palm Beach, FL.
- U.S. Army Corps of Engineers (USACE), 2014. Central Everglades Planning Project (CEPP) Final Integrated Project Implementation Report and Environmental Impact Statement. Jacksonville District. July 2014.
- VanZee, R., 2011. Regional Simulation Model-BasiNs (RSMBN), Documentation and User Manual. Hydrologic and Environmental Systems Modeling Dept., South Florida Water Management District, West Palm Beach, FL. March 28, 2011.

Appendix A – Tables of Assumptions

RSMBN:

- **ECB23L**
- **FWOL**

**Regional Simulation Model Basins (RSMBN)
Lake Okeechobee Component A Reservoir (LOCAR)
Existing Conditions (ECB23L) Baseline
Table of Assumptions**

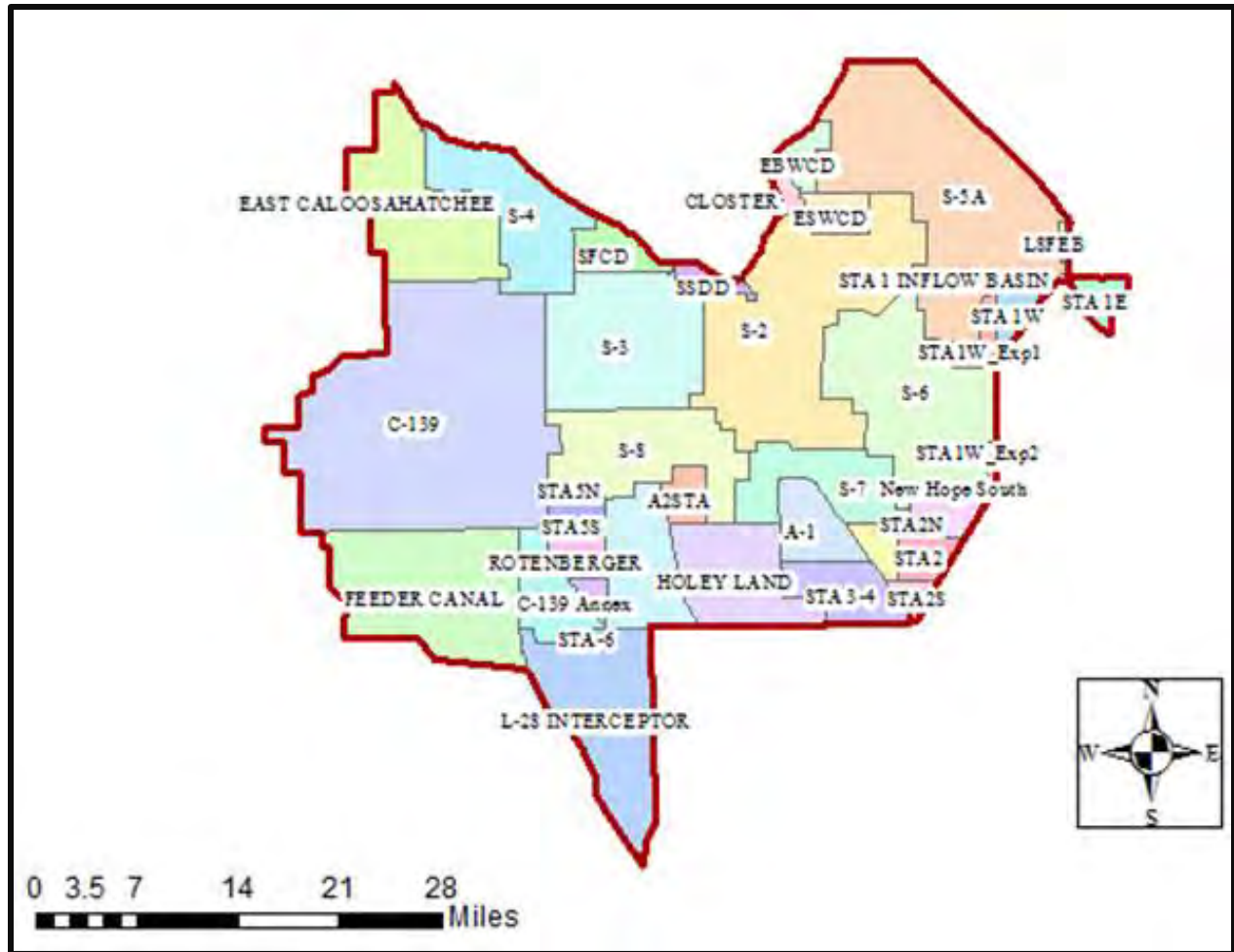
Feature	
Climate	<ul style="list-style-type: none"> • The climatic period of record is from 1965 to 2016 • Rainfall estimates have been revised and updated for 1965-2016, utilizing gauge interpolation through April 2002 and SFWMD NEXRAD from May 2002 to 2016 • Evapotranspiration datasets derived from NOAA’s North American Land Data Assimilation System and extended through 2016
Topography	<p>The Topography dataset for RSM was Updated in 2019 using the following datasets:</p> <ul style="list-style-type: none"> • South Florida Digital Elevation Model, USACE, 2017 (Interim) • High Accuracy Elevation Data, US Geological Survey 2007 • Loxahatchee River LiDAR Study, Dewberry and Davis, 2004 • Grassy Water Preserve, CWPB DEM (LiDAR based), Sep 2021 • St. Lucie North Fork LiDAR, Dewberry and Davis, 2007 • Palm Beach County LiDAR Survey, Dewberry and Davis, 2004 • Stormwater Treatment Area stage-storage-area relationships based on G. Goforth spreadsheets with updated effective areas per 2019 South Florida Environmental Report (SFER). • C139 basin topographic update based on available Everglades Agricultural Area (EAA) LiDAR, 2007
Land Use	<ul style="list-style-type: none"> • Lake Okeechobee Service Area (LOSA) Basins were updated using consumptive use permit information as of July 2017, as reflected in the LOSA Ledger produced by the Water Use Bureau • C-43 Groundwater irrigated basins – Permitted as of 2010, the dataset was updated using land use, aerial imagery and 2010 consumptive use permit information • Dominant land use in the EAA is sugar cane; other land uses consist of shrub land, wet land, ridge and slough, and sawgrass
LOSA Basins	<ul style="list-style-type: none"> • Lower Istokpoga, North Lake Shore and Northeast Lake Shore demands and runoff estimated using the AFSIRS model and assumed permitted land use (see land use assumptions row).
Lake Okeechobee	<ul style="list-style-type: none"> • Lake Okeechobee Systems Operating Manual (LOSOM) <ul style="list-style-type: none"> ○ Schedule modeling details as in LOSOM Preferred Alternative 2022 (PA22) scenario ○ No Lake Okeechobee regulatory releases to West Palm Beach Canal consistent with Restoration Strategies planning assumptions. ○ Lake Okeechobee regulatory releases limited to 1,550 cfs for Miami Canal and 1,350 cfs for North New River Canal based on studies performed by USACE. • Lake Okeechobee Water Shortage Management (LOWSM) Plan • Backpumping to Lake Okeechobee at S-2 and S-3 is minimized; since the model does not simulate EAA canal stages, triggering operations utilize 7-day moving average excess runoff surrogates • “Temporary” forward pumps as follows:

Feature	
	<ul style="list-style-type: none"> ○ S354 – 400 cfs ○ S351 – 600 cfs ○ S352 – 400 cfs ○ All pumps reduce to the above capacities when Lake Okeechobee stage falls below 10.2 ft and turn off when stages recover to greater than 11.2 ft in the dry season (Nov-May) and 10.5 in the wet season (Jun-Oct). • No reduction in EAA runoff associated with the implementation of Best Management Practices (BMPs); No BMP makeup water deliveries to the WCAs • Backpumping of 298 Districts and 715 Farms into Lake minimized
Northern Lake Okeechobee Watershed Inflows	<ul style="list-style-type: none"> • Kissimmee River inflows based on UKOPS model; operations for Lakes Kissimmee-Cypress-Hatchineha based on current interim Regulation Schedule (IRS-14-50). Lake Tohopekaliga and East Lake Tohopekaliga use the current (1981) regulation schedule with an addition of a spring recession operation. • Watershed inflows from the H&H version of the Kissimmee Basin MIKE-SHE/MIKE-11 Model (KB_HHFB16). Restored reaches / pools of Kissimmee River as of 2019 • Fisheating Creek, Istokpoga & Taylor Creek / Nubbin Slough Basin Inflows calculated from historical runoff estimates.
Caloosahatchee River Basin	<ul style="list-style-type: none"> • Caloosahatchee River Basin irrigation demands and runoff estimated using the AFSIRS model and assumed permitted land use as of July 2017 (see land use assumptions row). • Public water supply daily intake from the river is included in the analysis.
St. Lucie Canal & Estuary Basins	<ul style="list-style-type: none"> • St. Lucie Canal Basin demands estimated using the AFSIRS model and assumed permitted land use as of July 2017 (see land use assumptions row). • Excess C-44 basin runoff is allowed to backflow into the Lake if the lake stage is below 14.5 ft, NGVD. • St. Lucie Canal Basin demands include the Florida Power & Light reservoir at Indiantown. • Indian River Lagoon South Project features: <ul style="list-style-type: none"> ○ As-built Ten-mile Creek Reservoir and STA: 2,368 acre-feet maximum storage capacity at 4 ft maximum operating depth on 658 acres effective footprint (2 ft maximum depth on STA); receives excess water from North Fork Basin; operations per TMC Preliminary Operating Plan (SFWMD, June 2015). ○ C-44 Reservoir: 50,441 acre-feet storage capacity at 15 feet maximum depth on a 3,413 acres footprint. ○ Proposed C44 reservoir releases to estuary and to meet C-44 basin supplemental demands for surface water irrigation. ○ C-44 STA: 6,384 acres effective area.
Seminole Brighton Reservation	<ul style="list-style-type: none"> • Brighton reservation demands were estimated using AFSIRS method based on 2030 projected planted acreage provided by the Seminole Tribe of Florida and utilize the best available soil and evapotranspiration parameters reflecting local conditions on the Reservation.

Feature	
	<ul style="list-style-type: none"> • For the 52-year Period of Simulation (POS), this method results in a supplemental demand estimate of 52,938 ac-ft on an average annual basis. Estimated demands, and therefore deliveries, for every month of simulation do not equate to the monthly entitlement quantities as per Table 7, Agreement C-4121 (Nov. 1992). • Lake Okeechobee Water Shortage Management (LOWSM) applies to this agreement. On a monthly basis, water shortage management cutbacks are assumed to be deferred until after all entitlement volumes have been utilized.
<p>Seminole Big Cypress Reservation</p>	<ul style="list-style-type: none"> • Big Cypress Reservation irrigation demands and runoff were estimated using the AFSIRS method based on existing planted acreage • The 2-in-10 demand set forth in the Seminole Compact Work Plan equals 2,606 MGM • AFSIRS modeled 2-in-10 demands equaled 2,659 MGM • While estimated demands, and therefore deliveries, for every month of simulation do not equate to monthly entitlement quantities as per the District’s Final Order and Tribe’s Resolution establishing the Big Cypress Reservation entitlement, tribal rights to these quantities are preserved • LOWSM applies to this agreement
<p>Everglades Agricultural Area</p>	<ul style="list-style-type: none"> • Model water-body components as shown in Figure 1 below. • Simulated runoff from the North New River – Hillsboro basin apportioned based on simulated SFWMM flows for 2001–2016. • G-341 regulates water movement between S-5A Basin and Hillsboro Basin • EAA runoff and irrigation demand compared to SFWMM (ECB) simulated runoff and demand from 1965-2016 for reasonability • EAA ECP/RS STAs are simulated as single waterbodies consistent with 2019 SFER and recent construction efforts: <ul style="list-style-type: none"> ○ STA-1E: 4,994 acres effective area ○ STA-1E Distribution: 1,054 acres effective area ○ STA-1W: 10,818 acres effective area (includes expansion #1) ○ STA-2: cells 1,2 & 3: 6,509 acres effective area ○ STA-2N: cells 4,5 & 6; a.k.a. Comp B-North; 5,994 acres effective area ○ STA-2S: cells 7 & 8; a.k.a. Comp B-South; 2,995 acres effective area ○ STA-3/4: 16,327 effective total area ○ STA-5N: includes cells 1 & 2: 4,846 acres effective area ○ STA-5S: includes cells 3, 4 & 5; a.k.a. Compartment C: 6,856 acres effective area ○ STA-6: expanded with phase 2: 3,054 acres effective area • Assumed operations of STAs: <ul style="list-style-type: none"> ○ 0.5 ft minimum depth below which supply from external sources is triggered; ○ 4 ft maximum depth above which inflows are discontinued;

Feature	
	<ul style="list-style-type: none"> ○ Inflow targets established for STA-3/4, STA-2N and STA-2S based on DMSTA simulation; met from local basin runoff, LOK regulatory releases and available A1-FEB storage. ● A 15,853-acre Flow Equalization Basin (A1-FEB) located north of STA-3/4 with assumed operations as follows: <ul style="list-style-type: none"> ○ FEB inflows are from excess EAA basin runoff above the established inflow targets at STA-3/4, STA-2N, and STA-2S, and from LOK flood releases south. ○ FEB outflows are used to help meet established inflow targets (as estimated using the Dynamic Model for Stormwater Treatment Areas) at STA-3/4, STA-2N, and STA-2S if EAA basin runoff and LOK regulatory discharge are not sufficient. ○ 0.5 ft minimum depth below which no releases are allowed ○ 4.0 ft maximum depth above which inflows are discontinued ○ Assumed inlet pump from STA-3/4 supply canal to FEB with capacity equal to combined capacity of G-720 and G-721 structures. ○ Outflow weir, with similar discharge characteristics as STA-3/4 outlet structure, discharging into lower North New River canal. ○ Structure capacities and water quality operating rules are consistent with modeling assumptions assumed during the A-1 FEB EIS application process. ● A-2STA: 6,599 acres effective area; footprint is modeled, but the facility is not operational.
Holey Land Wildlife Management Area	<ul style="list-style-type: none"> ● G200 inflow structure, total of 300 cfs, operated to send lower Miami canal water into Holey Land. ● G-372HL inflow structure for fire protection used for keeping the water table from going lower than half a foot below land surface elevation. ● Operations are per the Holey Land Wildlife Management Area Draft Project Operations Manual (SFWMD, October 2015)
Rotenberger Wildlife Management Area	<ul style="list-style-type: none"> ● Operational Schedule as defined in the Operation Plan for Rotenberger WMA (SFWMD, March 2010)
Public Water Supply and Irrigation	<ul style="list-style-type: none"> ● Regional water supply demands to maintain Lower East Coast canals as simulated from RSMGL ECB22.
Western Basins	<ul style="list-style-type: none"> ● C139 basin runoff is modeled as follows: G136 flows is routed to Miami Canal; G342A-D flows routed to STA5N; G508 flows routed to STA5S; G406 flows routed to STA6. ● C139 basin demand is met primarily by local groundwater. ● C139 Annex flows routed to L28.
Eastern Flowway & North Palm Beach	<ul style="list-style-type: none"> ● Runoff simulated by RSMBN for the Upper and Lower basins of the Indian Trail Improvement District (ITID) M-1 watershed to correspond to previous regional modeling (SFWMM) adjusted based on updated GIS-based drainage basin delineation and historical data provided by ITID staff. (Note: ITID M-2 watershed is assumed to be part of the overall C-51W basin.) ITID M1 runoff discharges preferentially into C-51W canal, instead of the L-8

Feature	
	<p>Canal, subject to available M-1 canal conveyance (750 cfs total capacity) after passage of runoff from the Town of Royal Palm Beach. M-1 canal discharges into C-51W canal and are assumed to be released to the east via S-155A instead of to the west via S-319 pump station.</p> <ul style="list-style-type: none"> • L-8 FEB is simulated as a 950-acre, ~48,000 ac-ft reservoir with an inflow structure capacity of 3,000 cfs and an outflow pump capacity of 450 cfs; operations as described in the July 2015 L-8 Reservoir and FEB Draft Project Operations manual. It receives water primarily from the S5A and C-51W basins with coordinated closure of divide structure G-541 which prevents it from receiving water from the northern reaches of the L-8 Canal. • Grassy Waters Preserve is simulated and modeled with a maintenance level of 18.5 ft NGVD delivered via the M-Canal to supplement water supply demands to the City of West Palm Beach (41.2 MGD with 2016-2020 Seasonal Distribution) and releases via G161 toward the Loxahatchee Slough and River. Seepage losses are accounted for in both GWP and the conveyance route from Control 2 to GWP.
Water Shortage Rules	<ul style="list-style-type: none"> • Reflects the existing water shortage policies as in South Florida Water Management District Chapters 40E-21 and 40E-22, FAC, including Lake Okeechobee Water Shortage Management (LOWSM) Plan.



Water-Body Components:

- MIA Water-Body = S3 + S8
- NNR/HILLS Water-Body = S2 + S6 + S7 + New Hope South
- WPB Water-Body = S-5A
- A-1FEB = A-1

Figure A.1. RSMBN Basin Definition within the EAA for ECB23L

Notes:

- The RSM is a robust and complex regional scale model. Due to the scale of the model, it is frequently necessary to implement abstractions of system infrastructure and operations that will, in general, mimic the intent and result of the desired project features while not matching the exact mechanism by which these results would be obtained in the real world. Additionally, it is sometimes necessary to work within established paradigms and foundations within the model code (e.g. use available input-driven options to represent more complex project operations).
- The boundary conditions along the eastern and southern boundaries of the RSMBN model were provided from either the South Florida Water Management Model (SFWMM) or the RSM Glades-LECSA Model (RSMGL). The SFWMM was the source of the eastern boundary groundwater/surface water flows, while the RSMGL was the source of the southern boundary structural flows.
- LOCAR ECB23L assumptions were taken from and are consistent with the BBSEER ECB22 assumptions.

**Regional Simulation Model Basins (RSMBN)
Lake Okeechobee Component A Reservoir (LOCAR)
Future Without Project (FWOL) Baseline
Table of Assumptions**

Feature	
Climate	<ul style="list-style-type: none"> • The climatic period of record is from 1965 to 2016 • Rainfall estimates have been revised and updated for 1965-2016, utilizing gauge interpolation through April 2002 and SFWMD NEXRAD from May 2002 to 2016 • Evapotranspiration datasets derived from NOAA’s North American Land Data Assimilation System and extended through 2016
Topography	<p>The Topography dataset for RSM was Updated in 2019 using the following datasets:</p> <ul style="list-style-type: none"> • South Florida Digital Elevation Model, USACE, 2017 (Interim) • High Accuracy Elevation Data, US Geological Survey 2007 • Loxahatchee River LiDAR Study, Dewberry and Davis, 2004 • Grassy Water Preserve, CWPB DEM (LiDAR based), Sep 2021 • St. Lucie North Fork LiDAR, Dewberry and Davis, 2007 • Palm Beach County LiDAR Survey, Dewberry and Davis, 2004 • Stormwater Treatment Area stage-storage-area relationships based on G. Goforth spreadsheets with updated effective areas per 2019 South Florida Environmental Report (SFER). • C139 basin topographic update based on available Everglades Agricultural Area (EAA) LiDAR, 2007
Land Use	<ul style="list-style-type: none"> • Lake Okeechobee Service Area (LOSA) Basins were updated using consumptive use permit information as of July 2017, as reflected in the LOSA Ledger produced by the Water Use Bureau • C-43 Groundwater irrigated basins – Permitted as of 2010, the dataset was updated using land use, aerial imagery and 2010 consumptive use permit information • Dominant land use in the EAA is sugar cane; other land uses consist of shrub land, wet land, ridge and slough, and sawgrass
LOSA Basins	<ul style="list-style-type: none"> • Lower Istokpoga, North Lake Shore and Northeast Lake Shore demands and runoff estimated using the AFSIRS model and assumed permitted land use (see land use assumptions row).
Lake Okeechobee	<ul style="list-style-type: none"> • Lake Okeechobee Regulation Schedule per CEPP/EAA Reservoir Operations as in the C240 Scenario. <ul style="list-style-type: none"> ○ Based on LORS 2008 schedule lines + CEPP/EAA optimized release guidance in order to improve selected performance within LOK, the northern estuaries and LOSA while meeting environmental targets in the Glades. ○ Lake Okeechobee can send flood releases south through the Miami Canal and North New River Canal to the EAA Reservoir and A1FEB (if the FEB depth is below 2’) when the LOK stage is above the bottom of Zone D. ○ Lake Okeechobee can send flood releases south to help meet water-quality based flow targets at STA-3/4, STA-2N, and

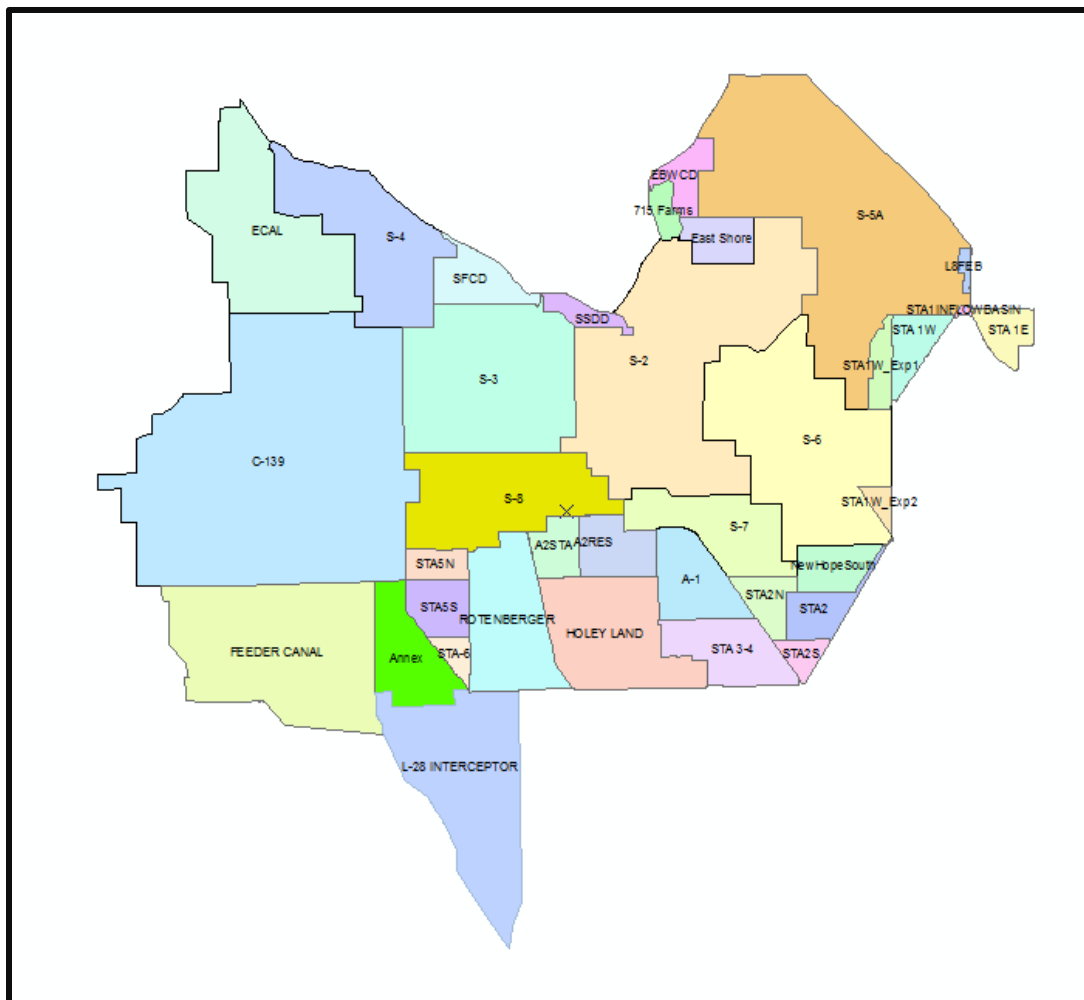
Feature	
	<p>STA-2S when the LOK stage is above the bottom of the Baseflow Zone.</p> <ul style="list-style-type: none"> ○ EAA basin runoff used to limit conveyance capacity: 2,550 cfs minus runoff for Miami Canal and 1,500 cfs minus runoff for North New River Canal. ○ Includes Lake Okeechobee regulatory releases to tide via L8 canal. ○ Releases via S-77 can be diverted into C43 Reservoir <ul style="list-style-type: none"> ● Lake Okeechobee Water Shortage Management (LOWSM) Plan ● Backpumping to Lake Okeechobee at S-2 and S-3 is minimized; since the model does not simulate EAA canal stages, triggering operations utilize 7-day moving average excess runoff surrogates ● “Temporary” forward pumps as follows: <ul style="list-style-type: none"> ○ S354 – 400 cfs ○ S351 – 600 cfs ○ S352 – 400 cfs ○ All pumps reduce to the above capacities when Lake Okeechobee stage falls below 10.2 ft and turn off when stages recover to greater than 11.2 ft in the dry season (Nov-May) and 10.5 in the wet season (Jun-Oct). ● No reduction in EAA runoff associated with the implementation of Best Management Practices (BMPs); No BMP makeup water deliveries to the WCAs ● Backpumping of 298 Districts and 715 Farms into Lake minimized
<p>Northern Lake Okeechobee Watershed Inflows</p>	<ul style="list-style-type: none"> ● Kissimmee River inflows based on UKOPS model; operations for Lakes Kissimmee-Cypress-Hatchineha based on proposed Headwaters Regulation Schedule (HRS-14-50). Zone A as defined in the 1996 SEIS, and Zone B modified per SFWMD scientists recommended restoration flow ramp (aka zone-discharge function). Lake Tohopekaliga and East Lake Tohopekaliga use the current (1981) regulation schedule with an addition of a spring recession operation. ● Watershed inflows from the H&H version of the Kissimmee Basin MIKE-SHE/MIKE-11 Model (KB_HHFB16). Restored reaches / pools of Kissimmee River as of 2019. ● Fisheating Creek, Istokpoga & Taylor Creek / Nubbin Slough Basin Inflows calculated from historical runoff estimates.
<p>Caloosahatchee River Basin</p>	<ul style="list-style-type: none"> ● Caloosahatchee River Basin irrigation demands and runoff estimated using the AFSIRS model and assumed permitted land use as of July 2017 (see land use assumptions row). ● Public water supply daily intake from the river is included in the analysis. ● C43 reservoir: maximum reservoir height of 41.7 ft NGVD with a 9,379-acre footprint in Western C43 basin with a 175,800 acre-foot effective storage. ● Proposed reservoir releases to estuary while C-43 basin supplemental demands for surface water irrigation are met by Lake Okeechobee.

Feature	
St. Lucie Canal & Estuary Basins	<ul style="list-style-type: none"> • St. Lucie Canal Basin demands estimated using the AFSIRS model and assumed permitted land use as of November 2016 (see land use assumptions row). • Excess C-44 basin runoff is allowed to backflow into the Lake if the lake stage is 0.25 ft below the low sub-band line. • St. Lucie Canal Basin demands include the Florida Power & Light reservoir at Indiantown. • Indian River Lagoon South Project features: • As-built Ten-mile Creek Reservoir and STA: 1,893 acre-feet maximum storage capacity at 3.6 ft maximum operating depth on 526 acres effective footprint; STA has 475 acre-feet maximum storage capacity at 3.6 ft maximum operating depth on 132 acres effective footprint; receives excess water from North Fork Basin; operations per TMC Preliminary Operating Plan (SFWMD, June 2015). • C-44 Reservoir: 50,441 acre-feet storage capacity at 15 feet maximum depth on a 3,413 acres footprint. • C44 Reservoir releases to estuary and to meet C-44 basin supplemental demands for surface water irrigation. • C-44 STA: 6,384 acres effective area. • C-23/C-24 North Reservoir: 32,677 acre-feet storage capacity at 16.5 ft maximum depth on a 2,005 acres footprint. • C-23/C-24 South Reservoir: 57,815 acre-feet storage capacity at 16.5 ft maximum depth on a 3,537 acres footprint. • C-23/C-24 STA: 1970 acres effective area.
Seminole Brighton Reservation	<ul style="list-style-type: none"> • Brighton reservation demands were estimated using AFSIRS method based on 2030 projected planted acreage provided by the Seminole Tribe of Florida and utilize the best available soil and evapotranspiration parameters reflecting local conditions on the Reservation. • For the 52-year Period of Simulation (POS), this method results in a supplemental demand estimate of 52,938 ac-ft on an average annual basis. Estimated demands, and therefore deliveries, for every month of simulation do not equate to the monthly entitlement quantities as per Table 7, Agreement C-4121 (Nov. 1992). • Lake Okeechobee Water Shortage Management (LOWSM) applies to this agreement. On a monthly basis, water shortage management cutbacks are assumed to be deferred until after all entitlement volumes have been utilized.

Feature	
Seminole Big Cypress Reservation	<ul style="list-style-type: none"> • Big Cypress Reservation irrigation demands and runoff were estimated using the AFSIRS method based on existing planted acreage • The 2-in-10 demand set forth in the Seminole Compact Work Plan equals 2,606 MGM • AFSIRS modeled 2-in-10 demands equaled 2,659 MGM • While estimated demands, and therefore deliveries, for every month of simulation do not equate to monthly entitlement quantities as per the District’s Final Order and Tribe’s Resolution establishing the Big Cypress Reservation entitlement, tribal rights to these quantities are preserved • LOWSM applies to this agreement
Everglades Agricultural Area	<ul style="list-style-type: none"> • Model water-body components as shown in Figure 1 below. • Simulated runoff from the North New River – Hillsboro basin apportioned based on simulated SFWMM flows for 2001–2016. • G-341 regulates water movement between S-5A Basin and Hillsboro Basin • EAA runoff and irrigation demand compared to SFWMM (ECB) simulated runoff and demand from 1965-2016 for reasonability • EAA ECP/RS STAs are simulated as single waterbodies consistent with 2019 SFER and recent construction efforts: <ul style="list-style-type: none"> ○ STA-1E: 4,994 acres effective area ○ STA-1E Distribution: 1,054 acres effective area ○ STA-1W: 10,818 acres effective area (includes expansion #1) ○ STA-2: cells 1,2 & 3: 6,509 acres effective area ○ STA-2N: cells 4,5 & 6; a.k.a. Comp B-North; 5,994 acres effective area ○ STA-2S: cells 7 & 8; a.k.a. Comp B-South; 2,995 acres effective area ○ STA-3/4: 16,327 effective total area ○ STA-5N: includes cells 1 & 2: 4,846 acres effective area ○ STA-5S: includes cells 3, 4 & 5; a.k.a. Compartment C: 6,856 acres effective area ○ STA-6: expanded with phase 2: 3,054 acres effective area • Assumed operations of STAs: <ul style="list-style-type: none"> ○ 0.5 ft minimum depth below which supply from external sources is triggered; ○ 4 ft maximum depth above which inflows are discontinued; ○ Inflow targets established for STA-3/4, STA-2N and STA-2S based on DMSTA simulation; met from local basin runoff, LOK regulatory releases and available A1-FEB storage. • EAA Reservoir: A 240 kac-ft storage reservoir located on 10,100 acre effective footprint (A2-RES) located north of Holeyland and assumed operations as follows: <ul style="list-style-type: none"> ○ A2-RES inflows are from excess EAA basin runoff above the established inflow targets at STA-3/4, STA-2N, and STA-2S, and from LOK flood releases south (up to ~ 4ft buffer depth from full level to allow attenuation of peak EAA runoff events). ○ A2-RES outflows are used to help meet established inflow targets (as estimated using the Dynamic Model for Stormwater

Feature	
	<p>Treatment Areas) at A1FEB, STA-3/4, STA-2N, STA-2S and ERSTA if EAA basin runoff and LOK regulatory discharge are not sufficient.</p> <ul style="list-style-type: none"> ○ 0.5 ft minimum depth below which no releases are allowed ○ 23.5 ft maximum depth above which inflows are discontinued ○ Inflows at the reservoir inflow pump station are assumed to convey up to 3000 cfs from the Miami canal and 1500 cfs from the NNR canal (combined basin runoff and Lake O water); inflow to the EAA reservoir can also be made from the existing G370 and G372 pump stations up to a 6 ft depth. ○ Supplemental irrigation demands in the Miami and NNR/Hillsboro basins can be met from the reservoir when reservoir depths exceed 8.2 feet. <ul style="list-style-type: none"> ● A 15,853-acre Flow Equalization Basin (A1-FEB) located north of STA-3/4 with assumed operations as follows: <ul style="list-style-type: none"> ○ FEB inflows are from excess EAA basin runoff above the established inflow targets at STA-3/4, STA-2N, and STA-2S, from releases from the EAA reservoir and from LOK flood releases south. ○ FEB outflows are used to help meet established inflow targets (as estimated using the Dynamic Model for Stormwater Treatment Areas) at STA-3/4, STA-2N, and STA-2S if EAA basin runoff and LOK regulatory discharge are not sufficient. ○ 0.5 ft minimum depth below which no releases are allowed ○ 4.0 ft maximum depth above which inflows are discontinued ○ Assumed inlet pump from STA-3/4 supply canal to FEB with capacity equal to combined capacity of G-720 and G-721 structures. ○ Outflow weir, with similar discharge characteristics as STA-3/4 outlet structure, discharging into lower North New River canal. ○ Structure capacities and water quality operating rules are consistent with modeling assumptions assumed during the A-1 FEB EIS application process. ● A-2STA: 6,599 acres effective area; facility is operational, receiving inflow directly from A-2 RES.
<p>Holey Land Wildlife Management Area</p>	<ul style="list-style-type: none"> ● G200 inflow structure, total of 300 cfs, operated to send lower Miami canal water into Holey Land. ● G-372HL inflow structure for fire protection used for keeping the water table from going lower than half a foot below land surface elevation. ● Operations are per the Holey Land Wildlife Management Area Draft Project Operations Manual (SFWMD, October 2015)
<p>Rotenberger Wildlife Management Area</p>	<ul style="list-style-type: none"> ● Operational Schedule as defined in the Operation Plan for Rotenberger WMA (SFWMD, March 2010)
<p>Public Water Supply and Irrigation</p>	<ul style="list-style-type: none"> ● Regional water supply demands to maintain Lower East Coast canals as simulated from RSMGL BBFWO.

Feature	
Western Basins	<ul style="list-style-type: none"> • C139 basin runoff is modeled as follows: G136 flows is routed to Miami Canal; G342A-D flows routed to STA5N; G508 flows routed to STA5S; G406 flows routed to STA6. • Full Restoration Strategies western flow path features including the C139FEB are not yet simulated by the RSM. • C139 basin demand is met primarily by local groundwater. • C139 Annex flows routed to L28.
Eastern Flowway & North Palm Beach	<ul style="list-style-type: none"> • Runoff simulated by RSMBN for the Upper and Lower basins of the Indian Trails Improvement District (ITID) M-1 watershed to correspond to previous regional modeling (SFWMM) adjusted based on updated GIS-based drainage basin delineation and historical data provided by ITID staff. (Note: ITID M-2 watershed is assumed to be part of the overall C-51W basin.) ITID M1 runoff discharges preferentially into C-51W canal, instead of the L-8 Canal, subject to available M-1 canal conveyance (750 cfs total capacity) after passage of runoff from the Town of Royal Palm Beach. M-1 canal discharges into C-51W canal and are assumed to be released to the east via S-155A instead of to the west via S-319 pump station. • L-8 FEB is simulated as a 950-acre, ~48,000 ac-ft reservoir with an inflow structure capacity of 3,000 cfs and an outflow pump capacity of 450 cfs; operations as described in the July 2015 L-8 Reservoir and FEB Draft Project Operations manual. It receives water primarily from the S5A and C-51W basins with coordinated closure of divide structure G-541 which prevents it from receiving water from the northern reaches of the L-8 Canal. • Grassy Waters Preserve is simulated and modeled with a maintenance level of 18.5 ft NGVD delivered via the M-Canal to supplement water supply demands to the City of West Palm Beach (41.2 MGD with 2016-2020 Seasonal Distribution) and releases via G161 toward the Loxahatchee Slough and River. Seepage losses are accounted for in both GWP and the conveyance route from Control 2 to GWP. • Features of the Loxahatchee River Watershed Restoration Projects although authorized, are not yet simulated in RSM.
Water Shortage Rules	<ul style="list-style-type: none"> • Reflects the existing water shortage policies as in South Florida Water Management District Chapters 40E-21 and 40E-22, FAC, including Lake Okeechobee Water Shortage Management (LOWSM) Plan.



Water-Body Components:

- MIA Water-Body = S3 + S8
- NNR/HILLS Water-Body = S2 + S6 + S7 + New Hope South
- WPB Water-Body = S-5A
- A-1FEB = A-1
- EAA Reservoir = A2RES

Figure A.2. RSMBN Basin Definition within the EAA for FWOL

Notes:

- The RSM is a robust and complex regional scale model. Due to the scale of the model, it is frequently necessary to implement abstractions of system infrastructure and operations that will, in general, mimic the intent and result of the desired project features while not matching the exact mechanism by which these results would be obtained in the real world. Additionally, it is sometimes necessary to work within established paradigms and foundations within the model code (e.g. use available input-driven options to represent more complex project operations).
- The boundary conditions along the eastern and southern boundaries of the RSMBN model were provided from either the South Florida Water Management Model (SFWMM) or the RSM Glades-LECSA Model (RSMGL). The SFWMM was the source of

the eastern boundary groundwater/surface water flows, while the RSMGL was the source of the southern boundary structural flows.

- LOCAR FWO assumptions were taken from and are consistent with the BBSEER FWO assumptions.

Appendix B – LOSOM Based Comparisons

As described in the MDR report, the Future Without Project condition (FWOL) assumes a LORS08-based schedule consistent with the current draft project operating manual for the EAA Reservoir. Recent project planning efforts have identified the LOSOM schedule as the successor to LORS08 and it is expected that future implementations of Lake Okeechobee regulation schedules will not return to LORS08-like protocols, but rather would continue to evolve the LOSOM-like operational mindset. To this end, a comparison set was developed to illustrate how the addition of the selected plan (LCR1) storage features would help to improve a system using consistent LOSOM-like protocols. While the ECB23L and LCR1 scenarios already utilized LOSOM protocols, the future without project condition was updated for this exercise to a new scenario that incorporated LOSOM operations. This scenario is called FWOLL (Future WithOut LOCAR – LOSOM, released 7/25/23) and when compared to the ECB23L and LCR1 created a more consistent Lake operational regime across the scenarios, thereby better illustrating the effects of LOCAR storage addition to the system. Due to the more intuitive nature of these comparisons and their better adherence to the latest operational mindsets, they were used extensively in the public engagement for LOCAR.

The RSMBN LOSOM-like modeling scenarios were reviewed from the perspective of ensuring that localized effects of project implementations were observed as expected and that regional performance was considered reasonable. Specific checks on RSM outputs included the following:

- Lake Okeechobee performance relative to LOSOM baselines are shown in **Figures B.1** and **B.2**. These figures illustrate that the LOCAR storage in combination with EAA reservoir storage has the ability to dramatically improve high Lake Okeechobee stage performance while simultaneously improving low Lake stage performance.
- Mean annual food control releases from Lake Okeechobee are shown in **Figure B.3** and illustrates that the LOCAR storage in combination with EAA reservoir storage has the ability to significantly increase flow south while reducing discharges east and west.
- For the northern estuaries, Lake triggered events relative to the LOSOM baselines are shown in **Figures B.4** and **B.5**. The figures illustrate low, optimum, high, and damaging flow events. In addition, the high and damaging events are further discretized into Lake Okeechobee and Basin events. It can be seen that the addition of storage reduces Lake-triggered damaging events and improve the optimal counts.
- LOSA and Tribal water supply relative to LOSOM baselines are shown in **Figures B.6** and **B.7**. **Figure B.6** illustrates the largest events for the LOSA demand cutback volumes. **Figure B.7** shows annual average irrigation supplies and shortages for the Seminole Tribe at the Brighton Reservation. The figures illustrate that the LOCAR and EAA storage both provide a supplemental source of irrigation supply and also reduce water shortage cutbacks relative to the existing condition.

In summary, the modeled LOSOM-like scenarios provided to the LOCAR project team are deemed to adequately represent the intended planning conditions and provide a reasonable basis of comparison to supplement the necessary evaluations required to draft the project report and to help facilitate public engagement for LOCAR.

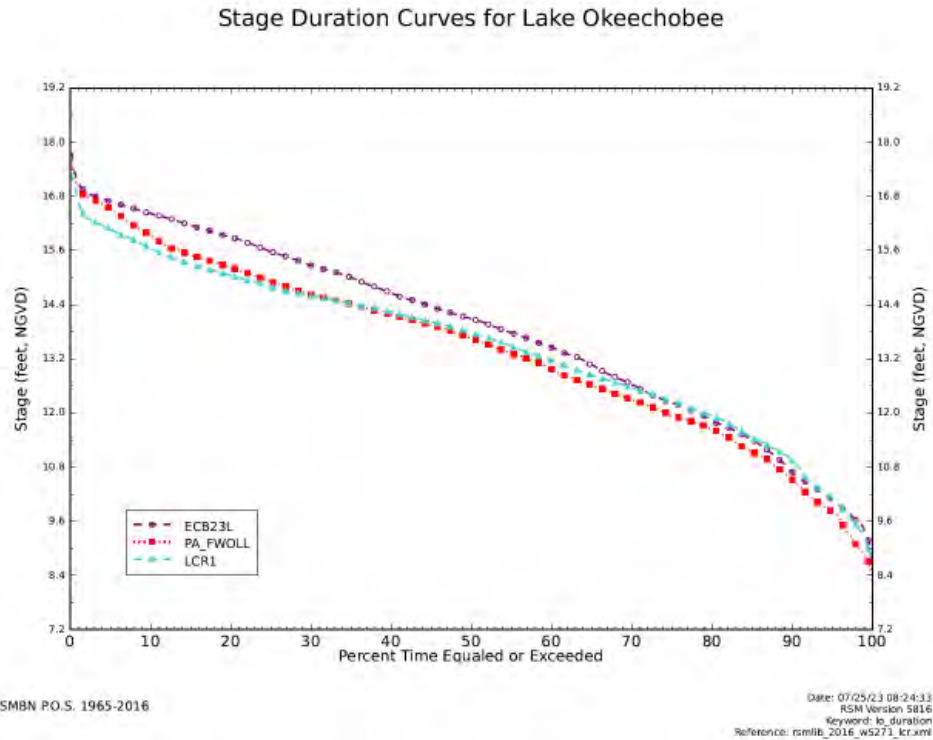


Figure B.1. Lake Okeechobee Stage Duration Curves Comparing LOSOM Baselines and Alternative LCR1.

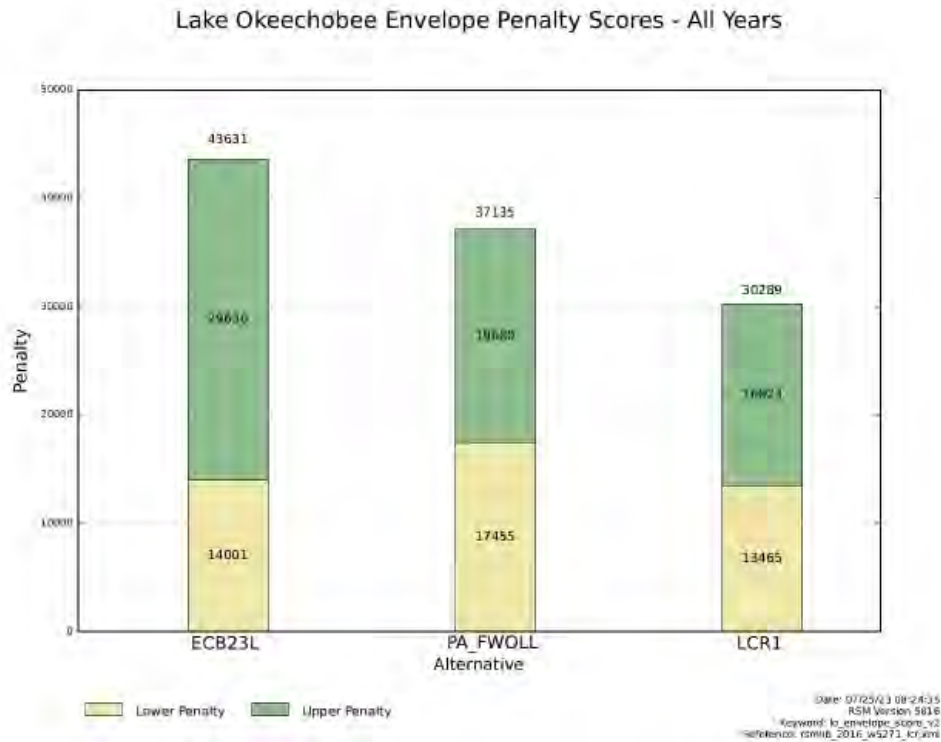


Figure B.2. Lake Okeechobee Stage Envelope Upper and Lower Penalties Comparing LOSOM Baselines and Alternative LCR1.

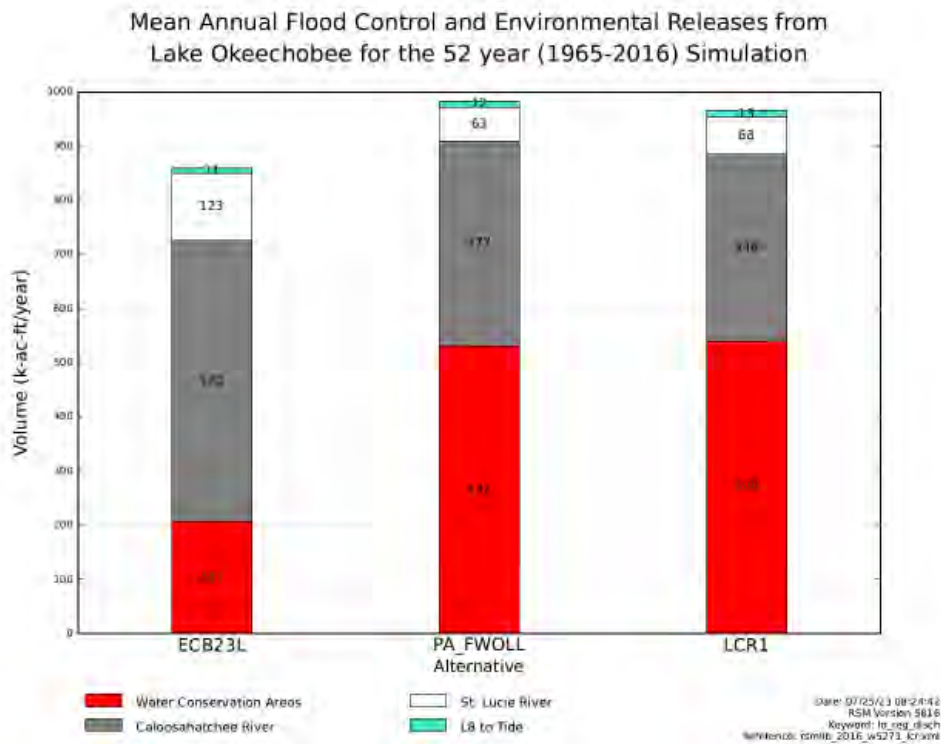


Figure B.3. Mean Annual Flood Control Releases from Lake Okeechobee (1965-2016).

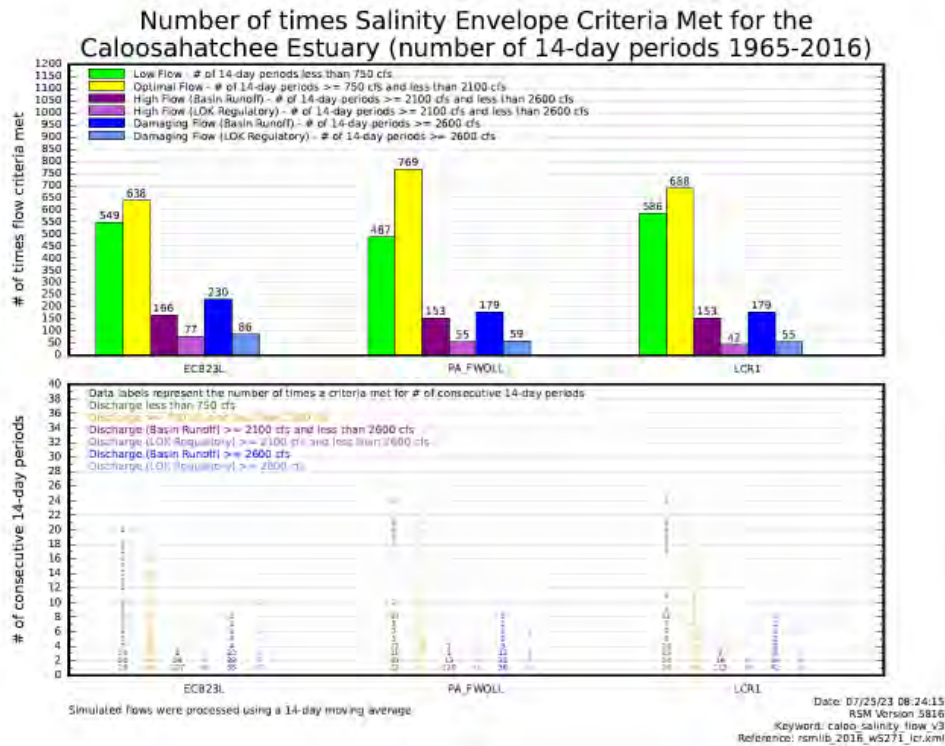


Figure B.4. Salinity Envelope Criteria for the Caloosahatchee Estuary.

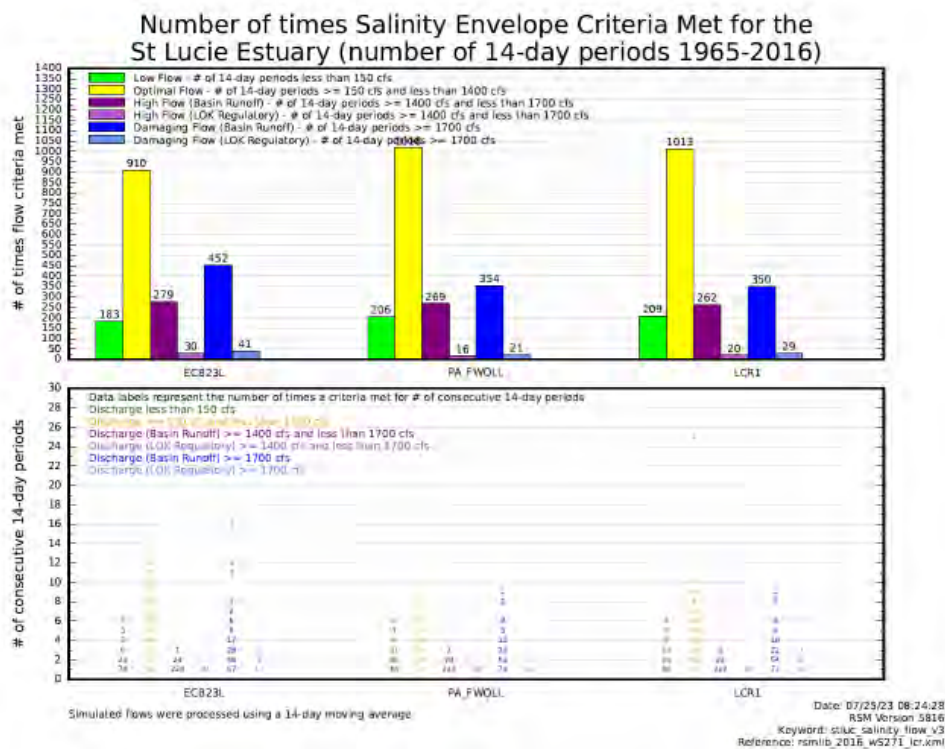


Figure B.5. Salinity Envelope Criteria for the St. Lucie Estuary.

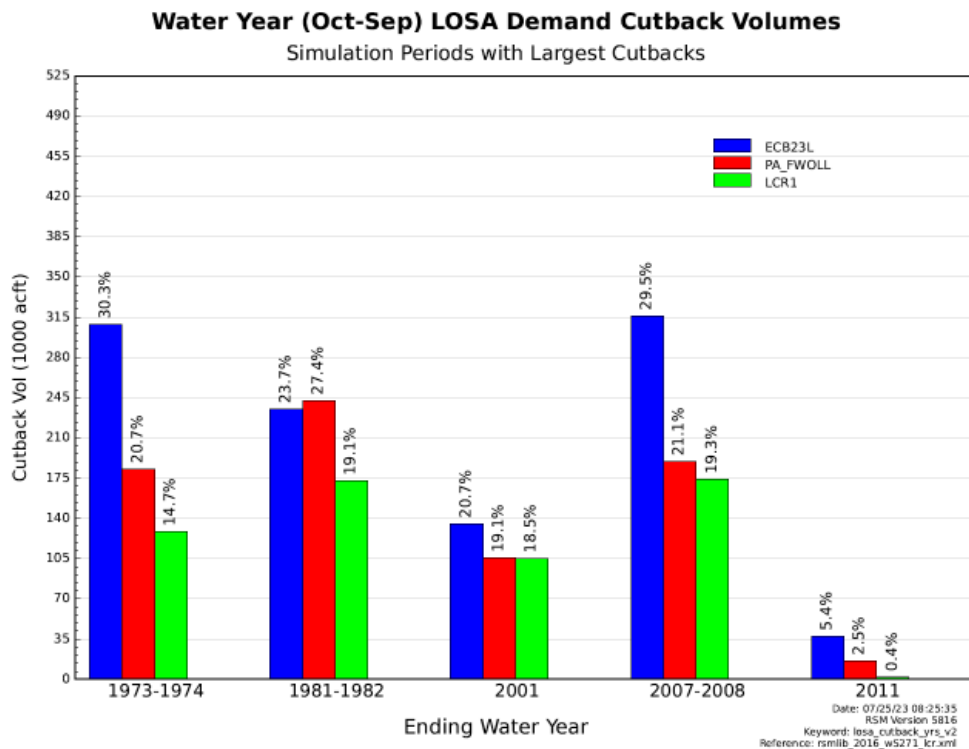


Figure B.6. LOSA Demand Cutback Volumes for Drought Events.

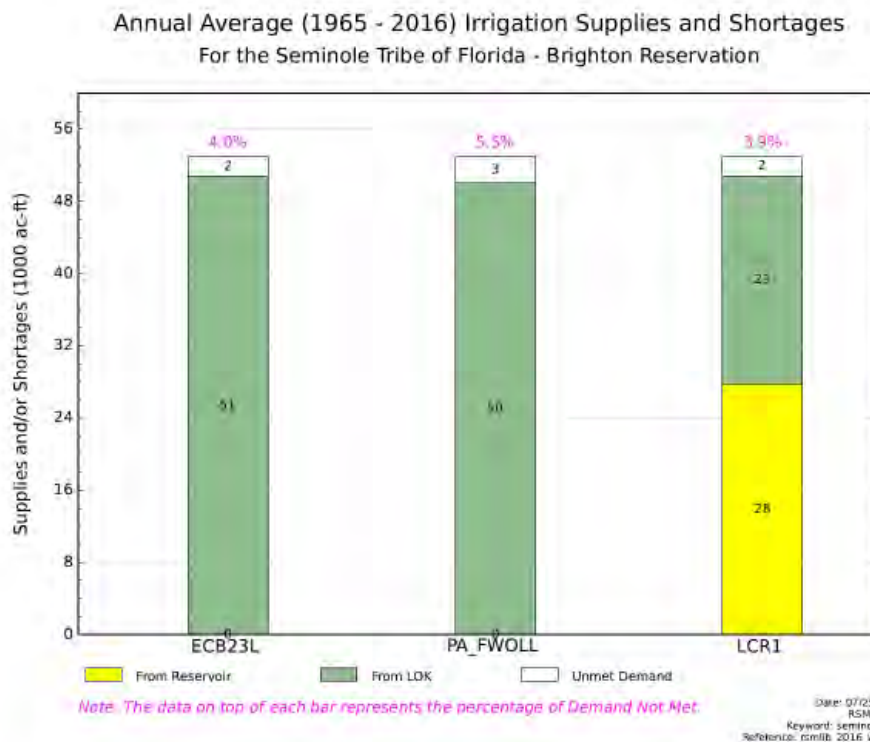


Figure B.7. Annual Average Irrigation Supplies for the Seminole Brighton Reservation.

Appendix C – LOCAR Reservoir Inflow Capacity Sensitivity

All LOCAR with-project scenarios assumed 1,500 cfs inflow conveyance capacity based on previous work in the C43 Reservoir and LOWRP efforts. While this value seems reasonable given the size of the proposed LOCAR storage (~ two month fill time) and given that the source of inflow is Lake Okeechobee which has an effectively unlimited supply, a sensitivity analysis was performed to confirm that additional inflow capacity was not required. A sensitivity scenario was built off of the selected plan (LCR1) that doubled the inflow capacity to 3,000 cfs and was named LCR1-3K. As can be seen in **Figures C.1** and **C.2** which show Lake Okeechobee stage envelope and discharge volumes, the LCR1-3K sensitivity does not perform meaningfully differently from the LCR1 scenario, thereby confirming that the addition of increased inflow capacity would not improve project performance measures.

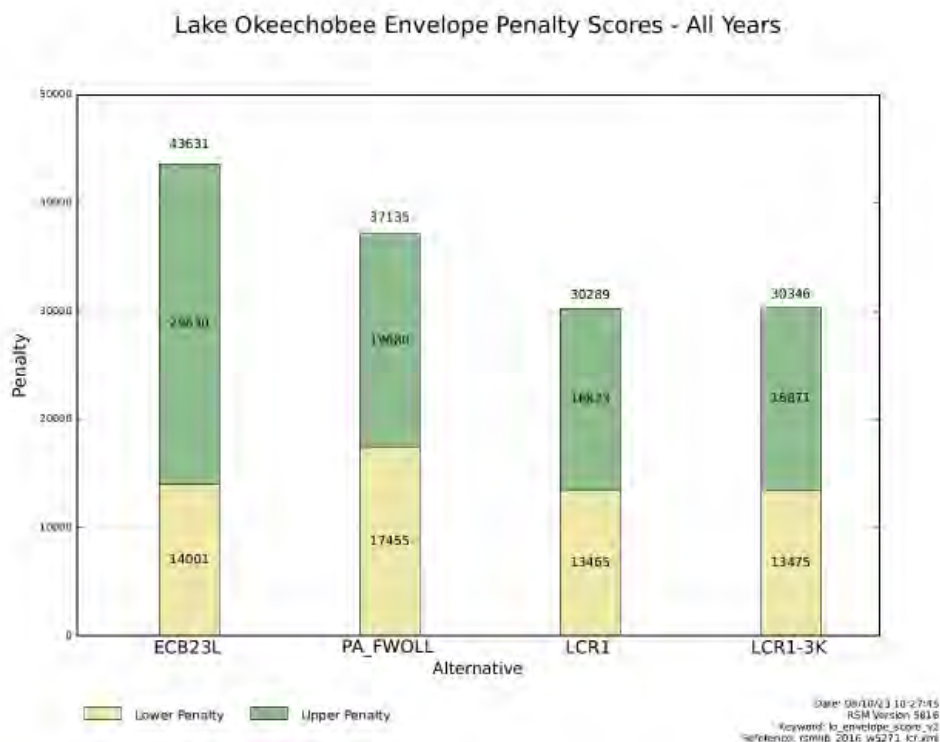


Figure C.1. Lake Okeechobee Stage Envelope Upper and Lower Penalties Comparing LOSOM Baselines, LCR1 and LCR1-3K Sensitivity Run.

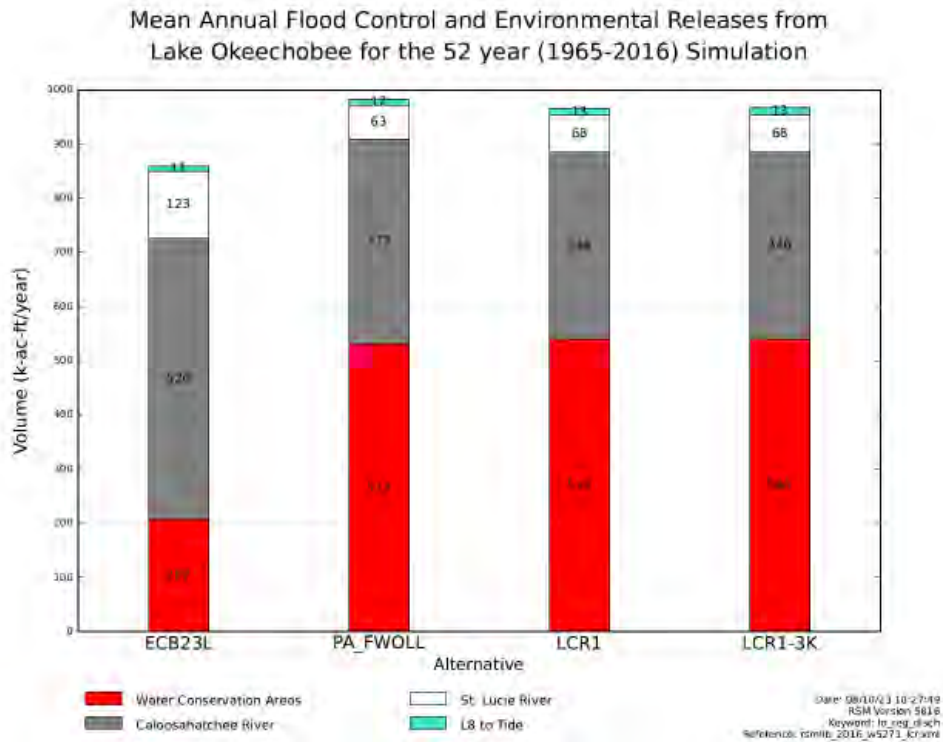


Figure C.2. Mean Annual Flood Control Releases from Lake Okeechobee (1965-2016).

Prepared for:	South Florida Water Management District
Prepared by:	J-Tech, an Alliance between Jacobs Engineering and Tetra Tech, Inc.
Date:	January 2024
Subject:	Lake Okeechobee Component A Storage Reservoir Feasibility Study Assessment of Allowable Wave Overtopping

1.0 Introduction

The Lake Okeechobee Component A Storage Reservoir (LOCAR) Project is currently being undertaken as part of the Comprehensive Everglades Restoration Plan (CERP), an approved framework for restoring the South Florida ecosystem while providing for other water-related needs of the region. The purpose of the LOCAR Project is:

- to store excess water in the northern watersheds for release at times when it is beneficial,
- to improve Lake Okeechobee’s ecology by reducing the duration and frequency of high water levels, and
- to reduce the likelihood of harmful releases from Lake Okeechobee to the northern estuaries.

As part of this project, the South Florida Water Management District (SFWMD) is undertaking a feasibility assessment for the design and construction of the LOCAR. Freeboard requirements for the reservoir are driven by potential overtopping due to wave action during extreme events and are determined so that the overtopping that occurs does not exceed a critical level, beyond which could lead to damage or failure of the embankment.

The selection of an allowable overtopping flow rate will have an impact on the required height of the embankment, which can have a significant impact on the construction cost. A wave wall was initially considered during the early phases of the concept design development as a cost effective means to minimize total embankment height. During various reviews with stakeholders, it was determined to propose an embankment design without the use of a wave wall, but with the potential to re-introduce the concept during the PED and final design phases. Final refinements during subsequent design phases are anticipated to further minimize the embankment height and its associated construction cost.

1.1 Objectives

The objective of this TM is to develop recommendations for an allowable mean overtopping flow for use in the LOCAR Feasibility Study.

1.2 Design Criteria

The SFWMD *Design Criteria Memorandum: DCM-2. Wind and Precipitation Design Criteria for Freeboard* (DCM-2) (SFWMD, 2006) presents joint design criteria and recommendations developed by the South Florida Water Management District (SFWMD), the US Army Corps of Engineers (USACE) and the Florida Department of Environmental Protection (FDEP) for developing wind speed and precipitation events for freeboard determination of CERP impoundments.

Four different design scenarios are specified by DCM-2. Preliminary overtopping analysis indicates that Design Case 2, which specifies use of a 100-year return period precipitation event and Category 5 windspeed acting

over the surface of the reservoir, will generate the greatest amount of overtopping and should be used to determine freeboard of the reservoir.

With respect to allowable overtopping, DCM-2 states:

“Because the impoundments will generally be constructed with highly erodible embankment shell material, freeboard design criteria of zero over-wash resulting from wind setup and wave action is desirable. Zero over-wash is not always required under infrequent high pool conditions. However, it is required that the over-wash not be of such magnitude and duration as to threaten the safety of the dam.”

DCM-2 does not provide guidance on specific tolerable over-wash rates for infrequent high pool conditions (which conditions resulting from design storm events are considered to be).

1.3 Approach

The ability of the embankments surrounding the LOCAR reservoir to resist erosion that, if excessive, could lead to failure of the embankments will be a function of both the erosion resistance of the embankment (including grass cover) and the length of time the embankment is exposed to erosive conditions.

Proposed overtopping rates for use in the LOCAR feasibility study consider general guidance for allowable overtopping rates recommended in the EurOtop manual (EurOtop, 2018) as well results and recommendations from overwash testing performed using soil at sites of three reservoirs in South Florida plus the Herbert Hoover Dike (HHD) that encircles Lake Okeechobee.

The results of two separate test programs were evaluated to assess their applicability for use in the feasibility study for the LOCAR reservoir.

In addition, the potential duration that the reservoir would see overtopping and the variability in overtopping that should be expected as the storm passed the reservoir were evaluated based on conservative assumptions related to the storm characteristics.

2.0 Review of Relevant Guidance/Data

2.1 Summary of Guidance/Test Reports

EurOtop (2018)

The EurOtop manual (EurOtop, 2018) guidance for tolerable overtopping for dikes and embankments subject to waves with significant wave heights (H_{m0}) between 1 and 3 meters (3.3 to 9.8 feet) is summarized in Table 1.

EurOtop (2018) notes that, although past guidance on tolerable overtopping rates relied solely on the mean discharge rate, tolerable overtopping depends very strongly on the peak volume of overtopping, and therefore on the wave height causing overtopping. The design significant wave height for the LOCAR reservoir for the embankment section with the longest fetch is on the order of 8 to 10 feet, which is at the upper end of wave heights in **Table 1** and, therefore, the values in **Table 1** could reasonably be considered to be applicable to the LOCAR reservoir.

Table 1. EurOtop recommended limits for grass covered dikes

Condition	Mean Discharge, q		Max Volume, V_{max}	
	l/s/m	cfs/ft	l/m	cf/ft
Grass covered crest and landward slope; maintained and closed grass cover; $H_{m0} = 1 - 3$ m	5	0.05	2000 - 3000	22 - 32
Grass covered crest and landward slope; not maintained grass cover, open spots, moss, bare patches; $H_{m0} = 0.5 - 3$ m	0.1	0.001	500	5
l/s/m = liters per second per meter l/m = liters per meter cfs/ft = cubic feet per second per foot cf/ft = cubic feet per foot				

Overwash testing on embankment dams in South Florida (Phillips et al, 2007).

Phillips et al (2007) documents the results of a full scale overwash test program performed on prototype embankments constructed at the EAA A-1, C-43, and C-44 reservoir sites. The tests consisted of the application of a variety of uniform flow rates ranging from 0.001 to 0.23 cfs/ft of embankment. Each test was run at the specified flow rate for an 8-hour duration.

Although the embankment at the EAA A-1 site was designed to be a grass slope underlain by a nine-inch topsoil layer, as a conservative portrayal of the erosion resistance of this material, a matrix of limestone fragments and carbonate silty sands which has a cementitious quality which was considered to be more resistant to erosion, the tests at the EAA A-1 site were conducted on the exposed surface of the embankment.

The sands at the C-43 and C-44 reservoir sites are characterized as clean fine-grained to silty sands. C-43 test embankment had been hydroseeded with a combination of millet, bahia, and Bermuda grass seed six months prior to the tests. No topsoil was applied prior to seeding and no additional maintenance was done following the initial seeding.

The C-44 test embankment slopes were planted using Bahia grass sod. No maintenance, other than mowing the embankment twice, was performed prior to testing eight months after installation of the sod. It was noted that the cover at C-43 was uniform in appearance but somewhat less dense than sodded slopes used at the C-44 test embankments.

As a result of these tests, a mean overwash rate of 0.01 cfs/ft of embankment was recommended for use in setting the freeboard for the C-43 and C-44 reservoirs and a mean overwash of 0.10 cfs/ft of embankment was

recommended for the EAA A-1 reservoir. A more conservative overwash rate of 0.005 cfs/ft of embankment was ultimately used in the final design of the C-43 reservoir (Hughes, 2017).

The sandy soil at the LOCAR site is expected to be more similar to that at the C-43 and C-44 reservoirs than the soil at EAA A-1 reservoir site.

Full-Scale Overtopping Simulation using Florida Sandy Soils (CSU, 2014).

CSU (2014) documents twelve full-scale wave overwash tests using the wave overtopping simulator at the Engineering Research Center in Colorado State University (CSU), Fort Collins, Colorado. Test trays were prepared in greenhouses at (CSU) using soils from the sites of four Florida reservoirs/dikes that were covered with Bahia grass sod. Soil was obtained from sites of the Herbert Hoover Dike (HHD), the C-43 reservoir, the C-44 reservoir, and the EAA A-1 reservoir.

Each test consisted of a series of 1-hour test segments in which the average wave overtopping discharge was held constant. The simulated wave heights and periods as well as grass coverage were varied between tests as shown in **Table 2**.

Table 2. Test Conditions for Overtopping Tests Documented in CSU (2014).

Soil	Test Number	Surface Treatment	Hs (ft)	Tp (sec)
HDD	1	50% Grass Coverage	8	7.7
	2	30% Grass Coverage	8	7.7
	3	30% Grass Coverage	5	7.7
C-43	4	50% Grass Coverage	4.7	3.4
	5	50% Grass Coverage	6.7	4.5
	6	HPTRM with 50% Grass Coverage	6.7	4.5
EAA A-1	7	50% Grass Coverage	6.7	4.5
	8	50% Grass Coverage	7.2	6.0
	9	Bare Soil	7.2	6.0
C-44	10	50% Grass Coverage	4.7	3.4
	11	50% Grass Coverage	6.7	4.5
	12	HPTRM with 50% Grass Coverage	6.7	4.5

H_s = Significant wave height
 ft = feet
 T_p = Peak wave period
 sec = seconds
 HPTRM = High-performance turf reinforcement mats

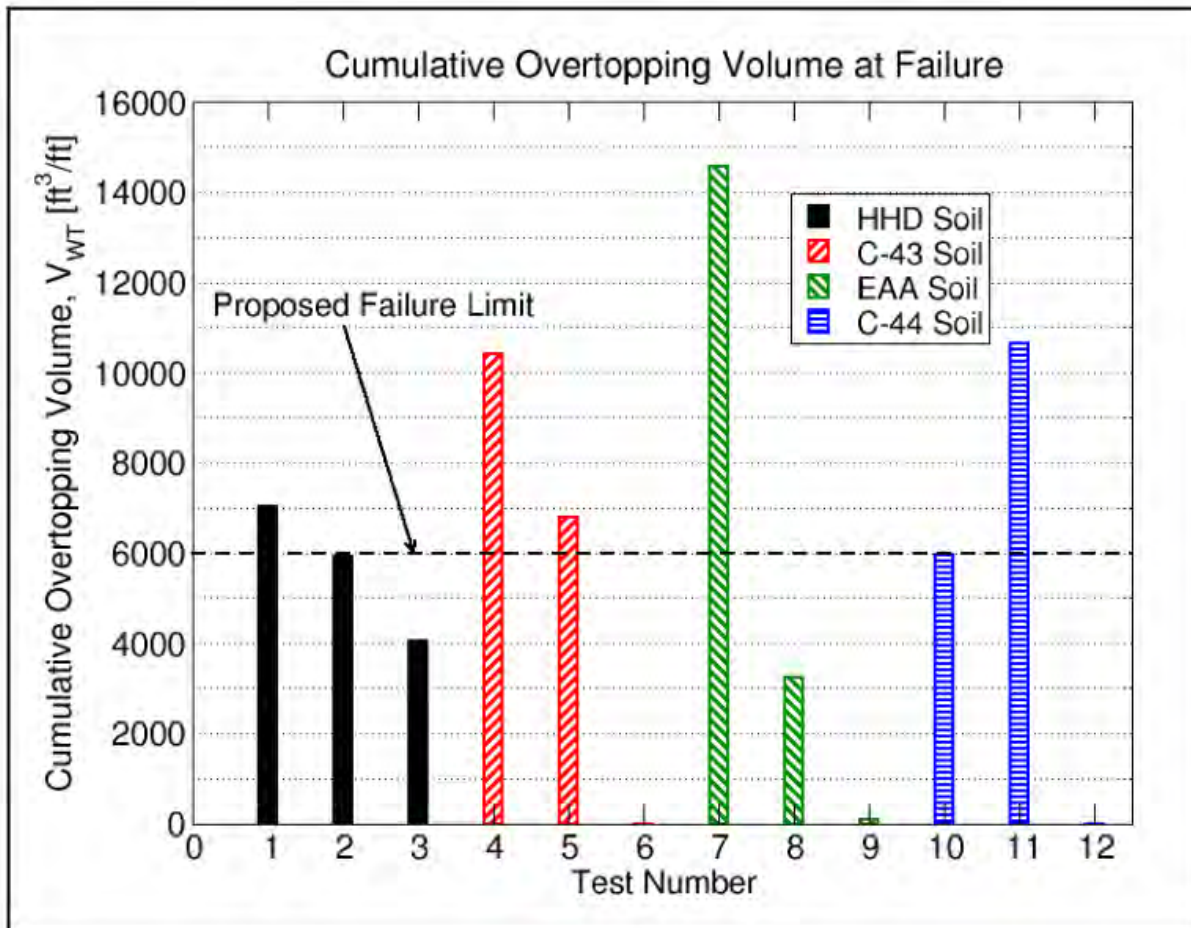
Results of the tests, based on the cumulative overtopping volume up to failure (**Figure 1**), were used to develop a “coarse failure criterion” of 6000 cubic feet per foot (cf/ft) of embankment which was considered to be useful for preliminary planning purposes.

Results for tests 6 and 12, which had high-performance turf reinforcement mats (HPTRM), are not presented in **Figure 1**.

The tests did not show significant differences between erosion resistance of the C-43, C-44, and HDD soil types. As noted in overwash tests described in Phillips et al (2007), the soil from the EAA A-1 reservoir site exhibited cementitious characteristics, with the soil in test number 7 showing a much greater resistance to erosion even after large sections of the sod had been lost.

Analysis of grass root parameters compared with the cumulative overtopping rates at failure confirmed that grass maintenance is important to ensure effective protection of the embankment slopes. It was concluded that if the root system of well-established grass cover is allowed to degrade, the risk of failure during an overtopping event will increase significantly.

Figure 1. Results and Proposed Coarse Failure Criterion from CSU (2014).



2.2 Discussion of Relevant Data for Establishing Tolerable Overtopping Rates

Although the tests described in Phillips (2007) do provide information on the erodibility of the embankment soil for the three reservoir sites, it did not simulate the characteristics of the overtopping flows that the reservoir embankments would see during an extreme event.

Rather than a constant overwash flow, overtopping due to waves occurs in pulses with a larger percentage, if not the majority of the overwash, occurring due to the largest waves that run up the embankment. As noted above, EurOtop (2018) indicates that tolerable overtopping depends strongly on the peak volume of overtopping from individual waves.

The LOCAR reservoir could see significant wave heights on the order of 8 to 10 feet, which will require a certain amount of freeboard over the Normal Full Storage Level (NFSL) in order to limit the mean overtopping rates to those tested in Phillips (2007). Overtopping of these waves will result in pulses of much higher velocity flow (and much higher shear stress) than simulated in these tests.

On the other hand, each test was run with a constant overtopping rate over a period of 8 hours and observed erosion at the end of each test represents the cumulative effect of that rate over the entire 8-hour period. In reality, the overtopping from a hurricane passing by or over the reservoir would be much more variable and transient. Winds (and associated waves) would build to a peak value as the storm approached the reservoir then would decrease after the storm passed. Also, windspeed within the storm will begin to abate over time after the storm makes landfall, so even if the storm stalls on top of the reservoir, the wind speed and wave conditions would decrease with time past its peak value.

Whether the erodibility data from these tests under- or over-represents the critical mean overtopping rate for the LOCAR reservoir is difficult to assess. It is likely that the overtopping rates in the tests in Phillips (2007) are an over-representation of the tolerable mean overtopping rates that the embankments could resist during a high wave event over the same period of time because it doesn't adequately simulate the peak overtopping flows. However, the 8-hour duration of each test is significantly longer than the potential time that peak wind and wave conditions would occur over the reservoir. Actual conditions during a storm will likely result in higher water velocities over the embankment, but over a shorter period of time.

The overtopping simulator at CSU provides a more realistic characterization of the overtopping flows for given wave characteristics. Based on tests performed using this simulator, CSU (2014) proposes a cumulative overtopping volume of 6000 cf/ft of embankment as a coarse failure criteria for preliminary planning purposes.

Data in CSU (2014) also indicates a linear correlation between grass root parameters (root volume x root length) and the cumulative overtopping volume at failure. This suggests that the proposed failure criteria is dependent on how well the root structure of the grass that is ultimately grown at the site is represented by the test sections which were grown in greenhouses at CSU. The quality of the grass cover that ultimately grows on the reservoir embankment is likely one of the largest uncertainties when applying model results from the CSU tests to the LOCAR reservoir.

A review of the test results shows that, with one exception, the tests sections for the HDD, C-43, and C-44 soils failed at a consistent mean overtopping rate. This occurred regardless of the cumulative overtopping volume or associated grass parameters.

Figure 2 shows a comparison of the cumulative overtopping volume at failure (**Figure 2a**) and the mean overtopping rate at failure (**Figure 2b**) for tests of these three soils. Tests 6 and 12, which included HPTRMs, and had much higher resistance to erosion are not included in **Figure 2**. The cumulative overtopping volume at failure varied from approximately 4000 cf/ft of embankment for test 3 to over 10,000 cf/ft for tests 4 and 11. The mean overtopping rate at failure varied from 0.6 cfs/ft of embankment for test 4 to 1.5 cfs/ft for test 11.

A closer look at the mean overtopping results and the varying test schedules for the different tests shows that, with the exception of test 11, all tests successfully resisted mean overtopping flows of 0.5 cfs/ft of embankment but failed on the next overtopping rate tested.

- Test 1 stepped flows from 0.5 to 1.0 cfs/ft and failed at 1.0 cfs/ft
- Tests 2, 3, 5, and 10 stepped flows from 0.5 to 0.7 cfs/ft and failed at 0.7 cfs/ft
- Test 4 stepped flows from 0.5 to 0.6 cfs/ft and failed at 0.6 cfs/ft

It should be noted that all tests were run for a total of between 4 and 5 hours which included lower overtopping flows as the tests stepped up to the peak flow at failure, with the exception of test 4 which, because of smaller step size, ran to 14 hours long before failing. It is noted that even with this longer test length and the associated greater cumulative overtopping volume, it still failed at a similar mean overtopping level as the other tests (with the exception of test 11).

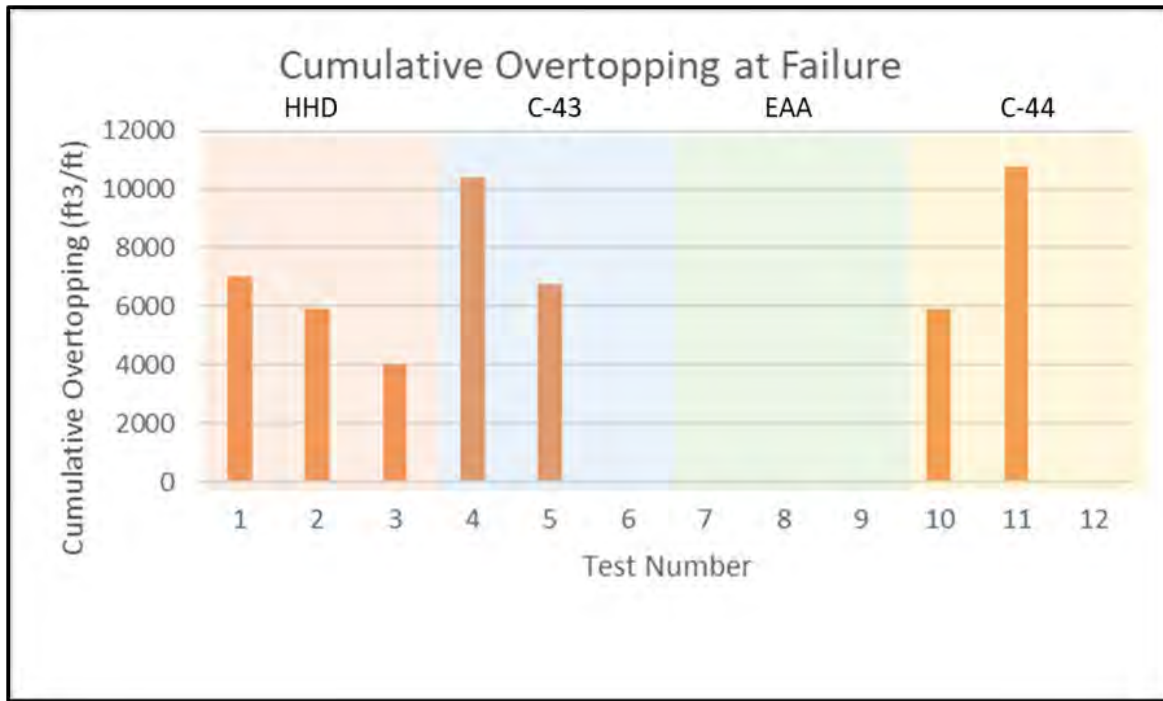
These results suggest that a mean overtopping rate of 0.5 cfs/ft of embankment could be tolerated for up to an hour (time span at which tests were run at 0.5 cfs/ft) for soils similar to those at the HDD, C-43, and C-44 reservoir sites and with similar grass cover.

The results from these tests are the most relevant available data for the LOCAR reservoir site, which has sandy soil characteristics similar to those at the HDD, C-43, and C-44 reservoir sites. Some conservativeness should be practiced when applying these results to the LOCAR reservoir due to uncertainties, including:

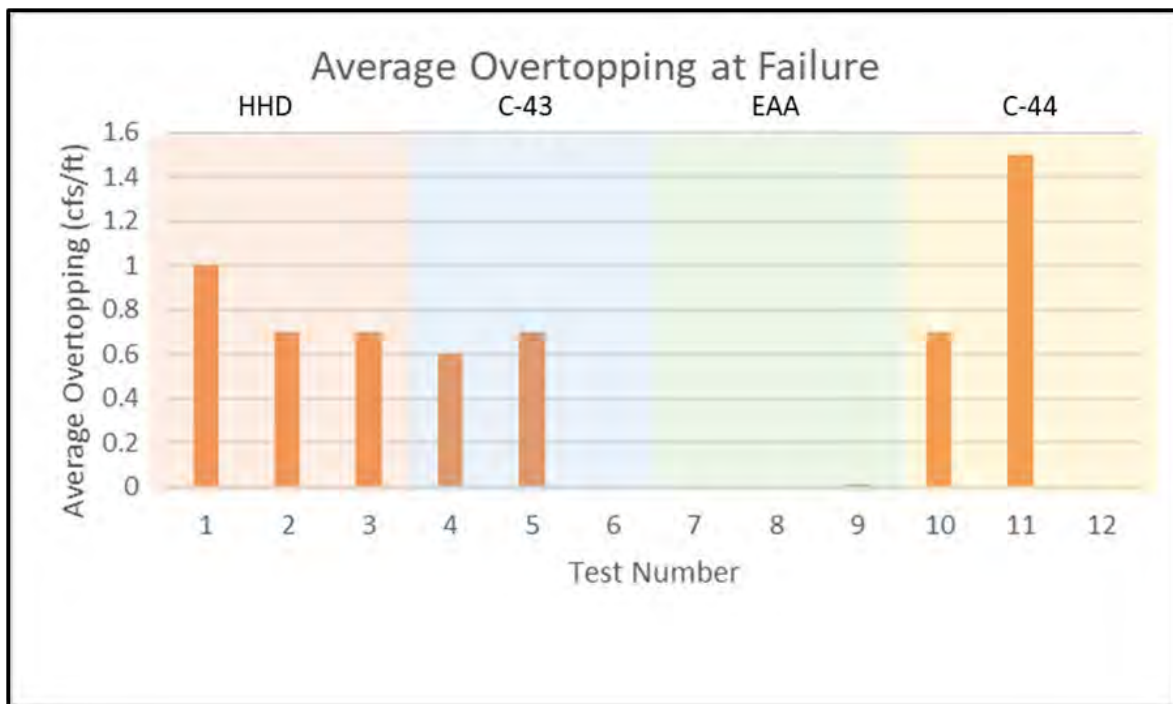
- Variability in conditions that are not represented in the limited number of test runs
- Differences in coverage and/or root structure between the grass cover on the LOCAR reservoir and the grass grown on the test sections at CSU
- Potential for degradation of the grass root structure over time (which could be exacerbated with effects of future climate variability)
- Storm duration at the peak wave/overtopping condition
- Contribution of precipitation to the flow over the embankment
- Differences in the length of the test sections compared with the LOCAR embankment length which could see increased water velocities and associated shear stresses as overtopping flows accelerate down the embankment

The potential for variations in grass cover characteristics from one section to another can be observed in the test results for tests 10 and 11. Both used soil from the C-44 site planted with 50% coverage of Bahia grass. Although wave conditions were smaller for test 10 (4.7 ft, 3.4 sec waves compared with 6.7 ft, 4.5 sec waves for test 11), the test section for test 11 was more resistant to failure of the grass by almost a factor of two for both measures (i.e. the cumulative overtopping volume and the mean overtopping flow at failure). This is counter to what would be expected based on the wave conditions alone and appears related to differences in the grass root structure between the two test sections.

Figure 2. Comparison of Cumulative vs Average Overtopping at Failure.



a) Cumulative overtopping at failure



b) Average overtopping at failure

3.0 Potential overtopping duration

Because erosion is a cumulative process, both the magnitude and duration of overtopping will be important in determining the potential for embankment failure.

The duration of overtopping flows during a storm will depend on the wind magnitude blowing across the reservoir as a function of time. For a hurricane, the time series of wind acting on the reservoir will depend on the path of the storm, the storm size, the profile of winds across the storm, the forward speed of the storm, and abatement of winds as the storm moves inland.

The following assumptions were made to get an idea of the potential overtopping as a function of time:

- **The reservoir is directly in the path of the hurricane.** This is considered the worst case in which winds blow in one direction (from left to right across the path of the hurricane) and build from the edge of the storm to the eyewall as the hurricane approaches, then reverse in direction and decrease as the storm subsides.
- **15-mile radius to peak winds.** Based on the National Weather Service's (NWS) "Hurricane Facts" (NOAA, 2023), a typical hurricane eye diameter is between 20 to 40 miles and a 15-mile radius represents a typical radius to the eye wall.
- **75-mile radius to the outer band of hurricane force winds.** Based on NWS "Hurricane Facts" (NOAA, 2023), hurricane force winds can extend more than 150 miles for a large hurricane.
- **125 mph peak wind at the hurricane eyewall.** Representative of a one-hour averaged Category 5 wind speed consistent with Design Case 2 from SFWMD (2006).
- **59 mph wind 75 miles from the hurricane center.** Representative of a one-hour averaged Category 1 windspeed.
- **Windspeed varies linearly from the eyewall to the outer edge of the storm.**
- **9, 12, and 20 mph storm forward speed,** corresponding with the approximate 50-, 75-, and 95-percentile forward speed of hurricanes based on a statistical analysis of historical hurricane tracks in the Florida Region documented in Jacobs (2018). Although slower forward speed would result in the hurricane passing over the reservoir for a longer time, the wind in a slower storm would also abate more as it moved from the coast to the site. It is assumed that a fast moving storm would be required to result in Category 5 strength winds at the site.

Wave heights were calculated on an hourly basis based on the wind time series determined from the wind profile and storm forward speeds assumed. Wave heights and periods were calculated using the Shore Protection Manual (USACE, 1984) empirical shallow water wave growth equation with results adjusted to be consistent with STWAVE model results for 125 mph wind documented in J-Tech (2023) for the East Cell with wind blowing from 330 true North. Wind setup was also recalculated based on the decreasing hourly wind speeds.

Mean overtopping rates were calculated based on methods from EurOtop (2018) for embankment heights of 71.9, 70.2, 68.4, and 66.0 feet NAVD88, corresponding to embankment heights for peak allowable overtopping rates of 0.05, 0.10, 0.2, and 0.5 cfs/ft of embankment (both pertaining to the exterior/landside of the crest of the embankment).

Results are plotted in **Figure 3** showing the decrease in mean overtopping rate with time for the four different embankment heights. Hour 0 in the plots represents the point the eye wall passes the reservoir with wind speeds decreasing linearly with time as the storm moves away. For the highest embankment, the mean overtopping rate is reduced from its peak rate of 0.05 cfs/ft of embankment by almost half over the first hour for the storm with a 9 mph forward speed. For comparison, the mean overtopping rate is reduced by about a factor of five over the first hour for the same storm with a forward speed of 20 mph. Overtopping essentially stops after about 2 hours for the fastest (20 mph) storm and after about 4 hours for the slowest (9 mph) storm.

Cumulative overtopping volumes were also calculated based on the hourly overtopping rates. These are summarized in **Table 3**. The maximum cumulative overtopping volume of 3824 cf/ft of embankment occurred for the case with an embankment height of 66.0 ft NAVD88 and a 9 mph forward storm speed. Comparison with the overtopping rates run during test 3 from CSU (2014) show a similar cumulative overtopping volume at failure (4048 cf/ft) and a similar hourly profile of mean overtopping rates, suggesting that the test schedules used in CSU (2014) may be representative of a large hurricane moving at an average forward speed (or slower for the case of test 4).

Figure 3. Results – Mean Overtopping Rates for Four Embankment Heights with Passage of a Hurricane.

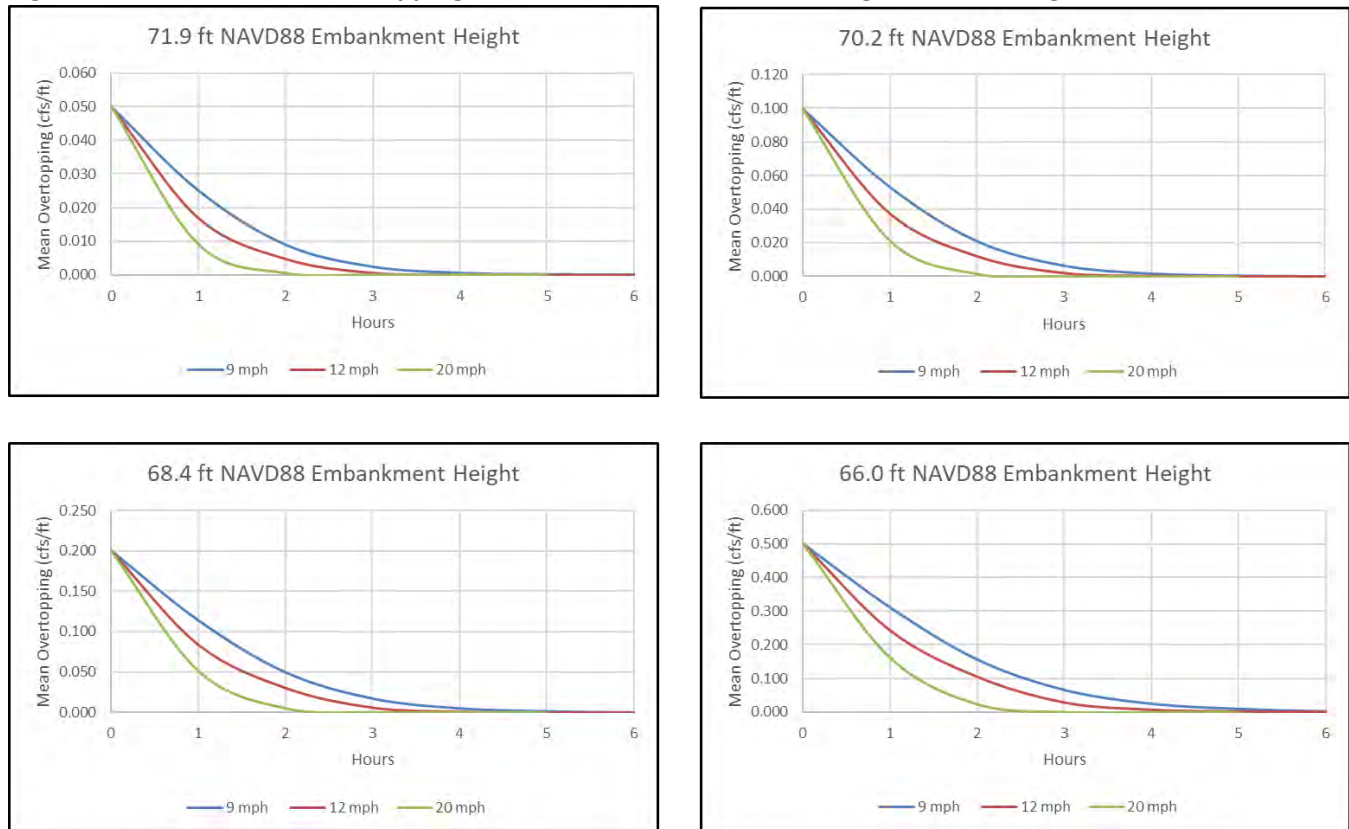


Table 3. Summary of Results – Cumulative Overtopping Volume.

Peak Average Overtopping Rate (cfs/ft)	Embankment Height (ft, NAVD88)	Storm Forward Speed (mph)	Cumulative Overtopping (cf/ft)
0.05	71.9	9	312
		12	260
		20	214
0.10	70.2	9	658
		12	545
		20	442
0.2	68.4	9	1394
		12	1155
		20	922
0.5	66.0	9	3824
		12	3161
		20	2470

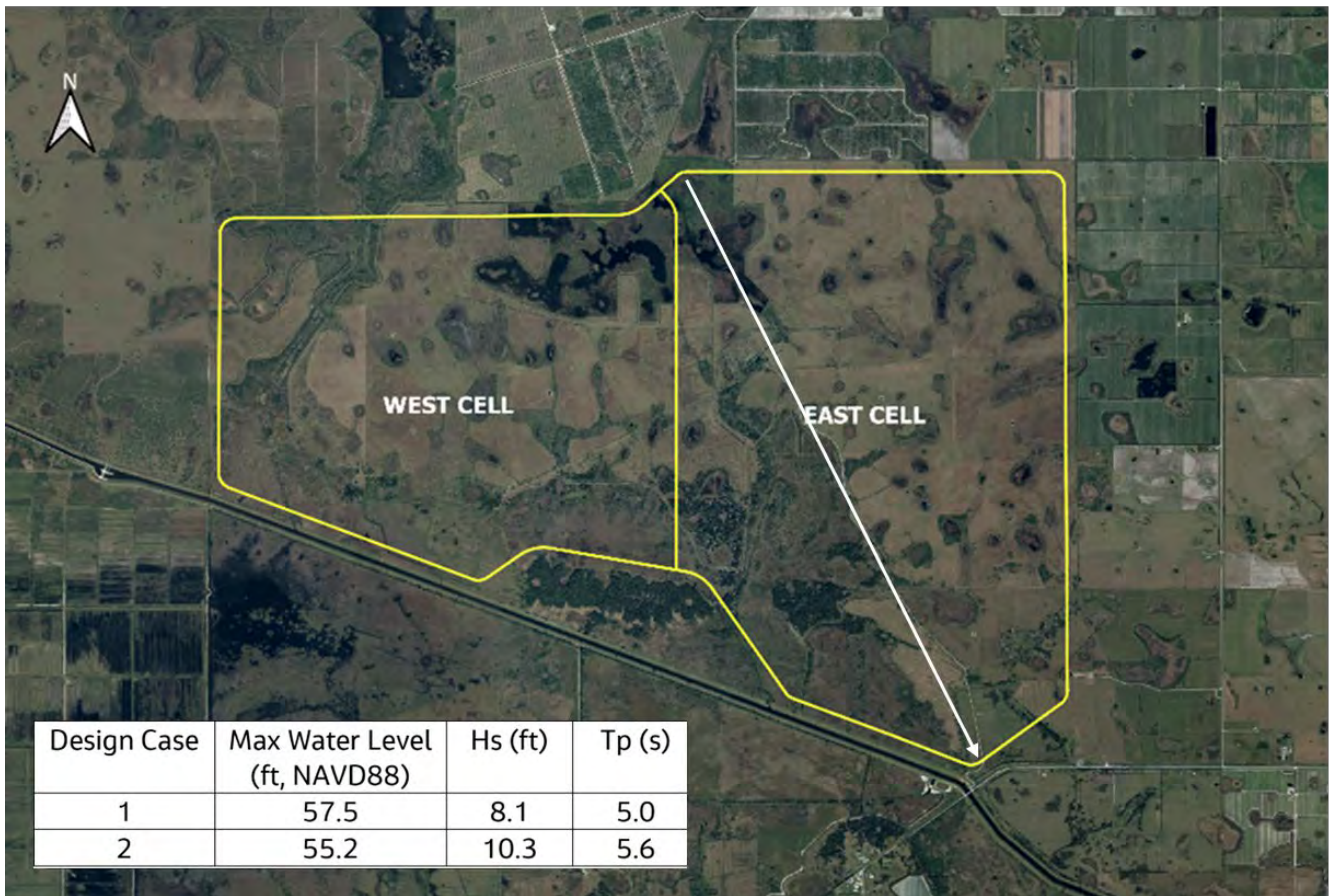
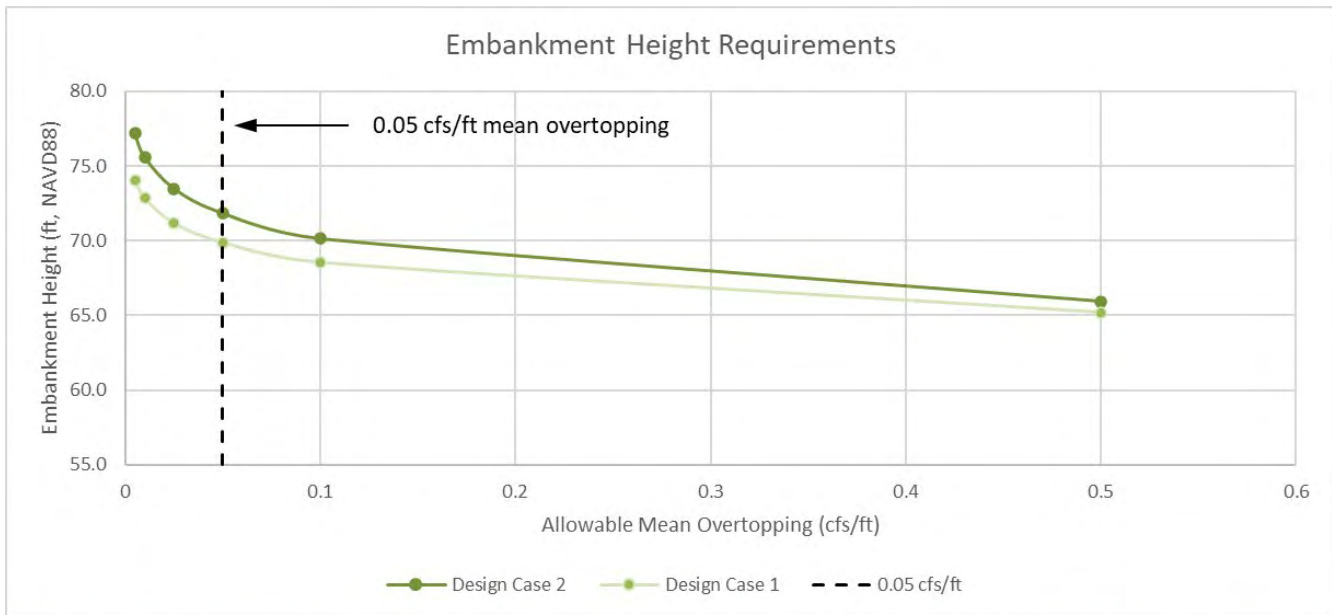
4.0 Implications for Embankment Height

Height requirements for the embankment (as measured at the top of the exterior/landside bank) were calculated for the embankment with no wave wall for allowable overtopping rates varying from 0.005 to 0.50 cfs/ft of embankment. Results are summarized in **Table 4** and plotted in **Figure 4** for Design Cases 1 and 2 for the reach with the maximum fetch in the East Cell of the LOCAR reservoir.

Table 4. Embankment Height Requirements.

Allowable Overtopping (cfs/ft)	Design Case 1 Embankment Height Requirements (ft, NAVD88)	Design Case 2 Embankment Height Requirements (ft, NAVD88)
0.005	74.1	77.2
0.01	72.9	75.7
0.025	71.2	73.6
0.05	69.9	71.9
0.10	68.5	70.2
0.50	65.2	66.0

Figure 4. Embankment Height Requirements as a Function of Allowable Overtopping.



5.0 Discussion

The evaluation of the potential overtopping duration is based on broad, but relatively conservative assumptions about storm size and speed. The results suggest that the test schedules used in tests documented in CSU (2018) may be representative of a large hurricane moving across the reservoir at moderate (50 percentile or slower) forward speeds. The test schedules used may lead to conservative estimates of cumulative overtopping volumes at failure as a Category 5 windspeed at the reservoir defined for Design Case 2 from SFWMD (2006) would likely require a fast moving storm due to abatement of wind with time as the storm moved from the coast to the site.

The evaluation of potential overtopping duration also suggests that tests documented in Phillips et al (2007) were run for durations that were much longer than the duration that would be seen during passage of a hurricane. Although this could lead to estimates of critical mean overtopping flows that are unrealistically low, the fact that the pulse flows from actual wave overtopping was not considered makes assessment of the representativeness of these tests for establishing overtopping rates difficult.

Results documented in CSU (2018) show a strong correlation between grass root parameters (root volume x root length) and the cumulative overtopping volume at failure indicating the quality of the grass cover is an important factor in the erosion resistance of the embankments. It is likely that the root system of grass grown on site in Florida will vary from that grown in greenhouses in Fort Collins, Colorado which increases the uncertainty associated with using the test results to establish overtopping rates for the LOCAR reservoir.

This uncertainty will increase with time as the root structure of the grass cover could vary in quality from year to year in response to weather conditions. The potential for more extremes in weather associated with future climate change will likely increase the potential for variability in root structure in response to seasonal weather conditions.

On the other hand, the test results for soils that should have relatively similar characteristics to those at the LOCAR site showed quite consistent resistance to overtopping (i.e. with one exception, all resisted mean overtopping rates of 0.5 cfs/ft, but failed at the next level tested). This was surprising based on differences in wave conditions and grass coverage from one test to the next.

EurOtop (2018) guidance recommends a mean overtopping rate of 0.05 cfs/ft of embankment for grass covered dikes with maintained grass cover, dropping to 0.001 cfs/ft for grass cover that is not maintained, which emphasizes the importance of the grass cover.

Results of the CSU (2018) tests suggest that higher mean overtopping rates than the 0.05 cfs/ft could be tolerated at the LOCAR site, particularly in light of the limited durations of peak wind speeds expected of the storms. However, caution should be exercised due to uncertainties associated with differences in grass cover quality between the test segments and grass grown at the site.

The contribution of precipitation on the embankment coincident with the wave overtopping, which is not factored into the EurOtop (2018) guidance or the two physical tests (CSU, 2014; Phillips et al, 2007), can also add to the flow over the embankment. Based on the rain inflow profile used during the routing analysis for Design Case 1 (CWR, 2023), the rate of runoff that flows off of the embankment during a 72-hour PMP event could be as much as 0.031 cfs/ft of embankment or more.

For Design Case 2, which is based on a 72-hour/100-year return period storm, scaling the peak flow from the 72-hour PMP calculations results in a peak rate for Design Case 2 of about 0.006 cfs/ft. Note that these are

average/steady flow rates rather than the pulses of flow that will occur due to wave overtopping and, while less likely to occur coincident with the peak wind during the storm, rainfall could potentially contribute to the total flows cascading on the downstream slope of the embankment. This suggests that rainfall may play a role in increasing the flows down the embankment, particularly if it persists for an extended period of time, and, depending on the length of slope, may contribute to additional erosion near the toe as the soil particles are mobilized in the flow. This additional consideration contributes to the argument for applying additional conservatism when specifying an acceptable mean overtopping rate, particularly at this phase of the design.

6.0 Recommendations

It is recommended that a mean overtopping rate of 0.05 cfs/ft of embankment be used for the purposes of the feasibility study. This is consistent with guidance provided in EurOtop (2018) for dikes with well maintained grass cover and is likely conservative, providing a factor of safety given the results of tests on sections with similar soil characteristics presented in CSU (2014) and in light of the transient nature of the storms. The conservativeness of this value depends to some extent on the quality of the grass at the site compared with the grass grown at the test facility in Colorado, the timing of additional rainfall and soil properties resisting erosive forces.

Further, as Figure 4 shows, the height reduction opportunities diminish moving from 0.05 cfs/ft and higher (to the right). At this stage in the analysis a slightly more conservative assumption is preferable to yield a more conservative cost estimate, giving more opportunity for refinement in the final design phases. A higher overtopping rate may be justifiable by the engineer of record for the final design of the reservoir; however, at this stage a more conservative value is recommended for the feasibility study.

7.0 References

CSU, 2014. Full-Scale Wave Overwash Resiliency Testing of Dikes and Embankments on Florida Sandy Soils. Prepared by Christopher I. Thornton, Steven A. Hughes, Bryan N. Scholl, and Natalie Youngblood. Prepared for US Army Corps of Engineers, Jacksonville District. Colorado State University Engineering Research Center. January 2014.

CWR, 2023. Lake Okeechobee Component A Storage Reservoir Feasibility Study – PMP Determination and PMF Routing. Prepared by Collective Water Resources on behalf of J-Tech, an alliance between Jacobs Engineering and Tetra Tech, Inc. Prepared for South Florida Water Management District. August 8, 2023.

EurOtop, 2018. Manual on wave overtopping of sea defenses and related structures. An overtopping manual largely based on European research, but for worldwide application. Van der Meer, J.W., Allsop, N.W.H., Bruce, T., De Rouck, J., Kortenhaus, A., Pullen, T., Schüttrumpf, H., Troch, P. and Zanuttigh, B., www.overtopping-manual.com.

Hughes, undated. Proposed methodology for Approximating Time-Varying Wave Overwash Leading to Dike Failure. Steven A. Hughes. Colorado State University – Engineering Research Center.

Hughes, 2017. Wave Overtopping and Wave Loading Analyses for the C043 Reservoir. Prepared by: Steven A Hughes. Prepared for Carollo Engineers, Inc. March 6, 2017.

Jacobs, 2018. Wave and Overtopping Analysis. Technical Memorandum. For the South Florida Water Management District. Issued 16 January 2018.

J-Tech, 2023. Lake Okeechobee Component A Storage Reservoir Feasibility Study – Wave Overtopping Analysis. Prepared by J-Tech, an Alliance between Jacobs Engineering and Tetra Tech, Inc. Prepared for South Florida Water Management District. 11 August 2023.

NOAA, 2023. Hurricane Facts. [Hurricane Facts \(weather.gov\)](https://www.weather.gov/hurricane-facts). Accessed 24 October 2023.

Phillips et al, 2007. Over the top – Results from overwash testing on embankment dams in South Florida. Bruce A. Phillips, Becky J. Hachenburg, and Kevin C. Clark, MWH Americas, Inc, and Jeffrey R Kivett, South Florida Water Management District. ASDSO conference paper final submission. July 27, 2007.

SFWMD, 2006. Design Criteria Memorandum: DCM-2. Wind and Precipitation Design Criteria for Freeboard. South Florida Water Management District. February 6, 2006.

USACE, 1984. Shore Protection Manual. Fourth Edition. Coastal Engineering Research Center. Department of the Army. 1984

Prepared for:	South Florida Water Management District
Prepared by:	J-Tech, an Alliance between Jacobs Engineering and Tetra Tech, Inc.
Date:	February 16, 2024
Subject:	LOCAR Section 203 Feasibility Study (FS) Overview of Reservoir Perimeter Canal System Modeling

1.0 Introduction

HEC-RAS 1-D models were developed to evaluate potential drainage impacts of the Recommended Plan (project) on the drainage basins surrounding the reservoir site, which currently discharge stormwater through the reservoir site to the C-41A canal (via the existing ditches within the reservoir site, which drain to the project culverts along the north side of C-41A). To evaluate the potential impacts, an existing condition model and a proposed condition model were coded to evaluate the effects of the project. To ensure that the proposed project will not interrupt the existing drainage pattern of the drainage basins surrounding the reservoir site, nor increase peak flood stages within these basins, the project includes a perimeter canal around the reservoir designed to simultaneously convey peak seepage flows from reservoir (intercepted by the perimeter canal as described in **Section A.9** of the FS report) and peak stormwater discharges from the reservoir site and adjacent offsite basins (that historically drain to the reservoir site) to C-41A. The HEC-RAS 1-D models were used to determine the effectiveness of the perimeter canal to meet this design intent. The objective of the HEC-RAS 1-D modeling presented in this technical memorandum is to evaluate stormwater stage changes in basins around the reservoir site resulting from the construction of the Recommended Plan. The spatial extent of the existing and proposed condition models is shown in **Figure 1**.

As described in **Section A.9** and shown in **Figures 26 and 27**, the proposed perimeter canal includes a series of cascading reaches (Reaches 1A through 6) controlled by adjustable weirs, which drain to C-41A via Reach 7, that will be adjusted as needed throughout the annual wet and dry seasons, so that the stage in each reach matches as closely as possible the average existing condition (or pre-project) groundwater table elevation of the adjacent offsite basins, in order to minimize impacts to the groundwater table in these basins by the seepage outflows from the reservoir.

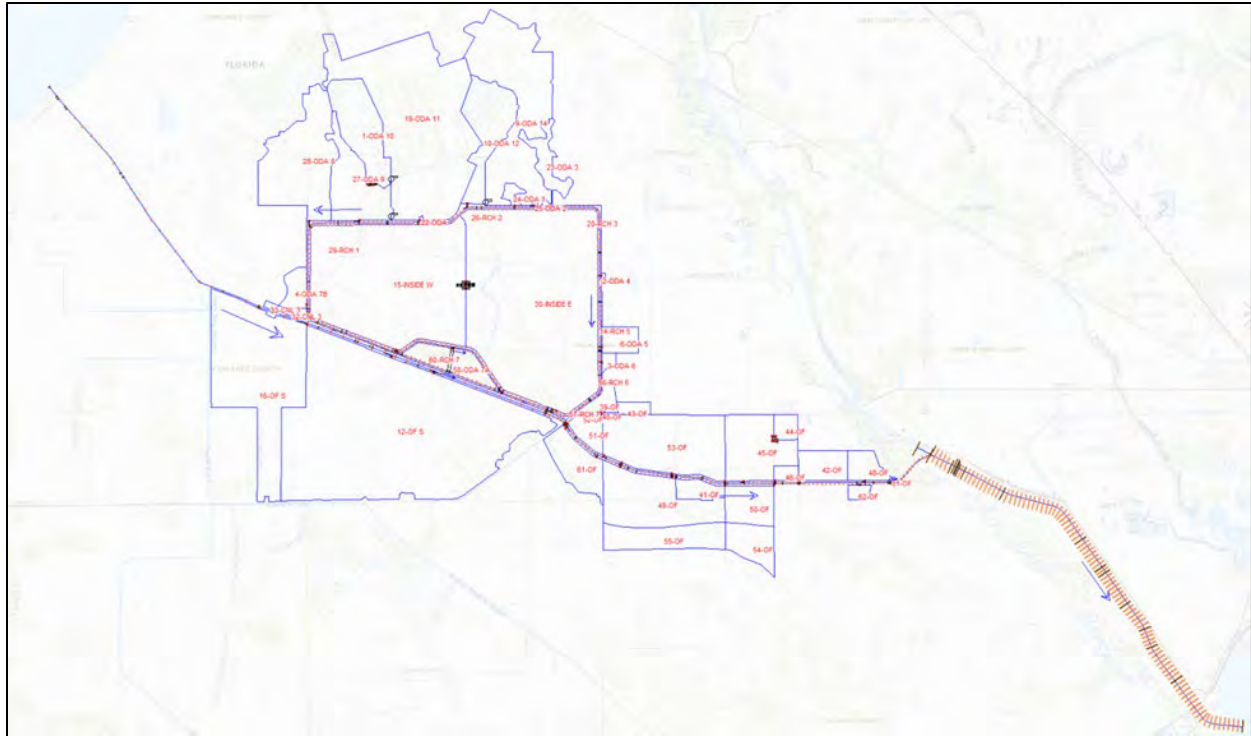


Figure 1. Spatial Extent of HEC-RAS Existing and Proposed Condition Development models.

2.0 Hydrology

Hydrologic information needed for the 1-D HEC-RAS models, including inflow hydrographs for the basins, was developed using USACE HEC-HMS Software version 4.11. Soil Conservation Service (SCS) methods were used to develop the runoff files using the SFWMD 72-hour hydrograph for the 10-year, 3-day and 100-year, 3-day storms, shown in **Figure 1A**, with rainfall depths of 7.0 and 10.9 inches, respectively (obtained from NOAA Atlas 14).

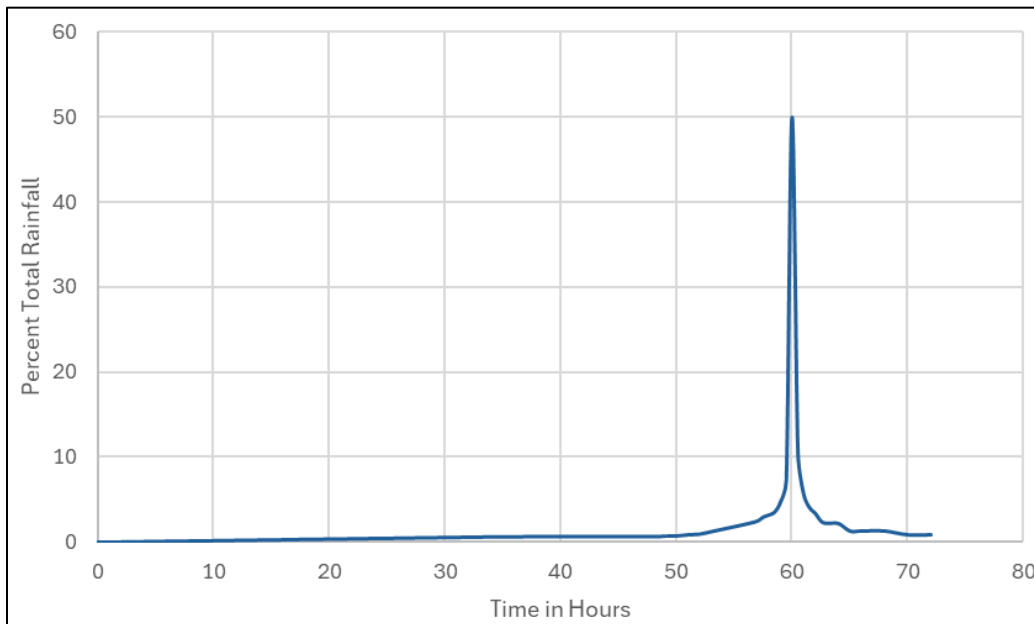


Figure 1A. SFWMD 72-Hour Rainfall Distribution used for 10 and 100-Year Storms.

Runoff estimates used SCS runoff curve numbers calculated by overlaying the land use and soil coverages and developing a composite CN. Hydrograph data was saved into a Data Storage System (DSS) file for use in HEC-RAS. DSS files store the time versus runoff relationship of the basins. CN values were generally in the upper eighties due to the high water table in the soils. Typically, the pastures had minimal drainage systems that would not have lowered the water table, contrasted with the grove areas that are well drained with CN values in the seventies. The percentage of each hydrologic group represented in the entire existing condition model and proposed condition model is summarized in **Table 1**.

Table 1. Basin Hydrologic Groups.

Hydrologic Group	Percentage of Entire Model (same percentages for existing and proposed condition models)
A	1
A/D	65
B/D	27
C/D	6

Lag time for the basins was developed using the SCS Watershed Lag Method found in the SCS National Engineering Handbook, chapter 15, shown in **Figure 1B**, which uses flow length, slope, and CN. Average flow velocities through the basins was 0.2 feet per second. Lag times are shown in **Table 4**.

(a) Watershed lag method

The SCS method for watershed lag was developed by Mockus in 1961. It spans a broad set of conditions ranging from heavily forested watersheds with steep channels and a high percent of runoff resulting from subsurface flow, to meadows providing a high retardance to surface runoff, to smooth land surfaces and large paved areas.

$$L = \frac{\ell^{0.8} (S+1)^{0.7}}{1,900Y^{0.5}} \quad (\text{eq. 15-4a})$$

Applying equation 15-3, $L=0.6T_c$, yields:

$$T_c = \frac{\ell^{0.8} (S+1)^{0.7}}{1,140Y^{0.5}} \quad (\text{eq. 15-4b})$$

where:

- L = lag, h
- T_c = time of concentration, h
- ℓ = flow length, ft
- Y = average watershed land slope, %
- S = maximum potential retention, in
- $= \frac{1,000}{cn'} - 10$

where:

- cn' = the retardance factor

Figure 1B. Watershed Lag Method from SCS National Engineering Handbook.

Basins were delineated within the SFWMD C-41A watersheds. The existing condition and proposed condition drainage maps for the LOCAR Section 203 study (**Figures 25 and 26**, respectively), as well as SFWMD environmental resource permits and drainage reports were used to determine basin boundaries, including the report “Engineering Report of Proposed Surface Water Management Basins III & IV Lykes Bros. – Basinger Tract” by Hutcheon Engineers, dated October 12, 1984 (Hutcheon report). Basin boundaries were also drawn along the outer edge of the reservoir footprint.

In the proposed condition model, the basins outside of the reservoir footprint remained the same as in the existing condition model. Within the reservoir footprint, for the proposed condition model, the east and west cells were added along with the perimeter canal segments that surround the reservoir. The existing condition and proposed condition model basin boundaries are shown in **Figures 2 and 3**, respectively. Note, that only the basins within the reservoir have been changed for the existing condition model.

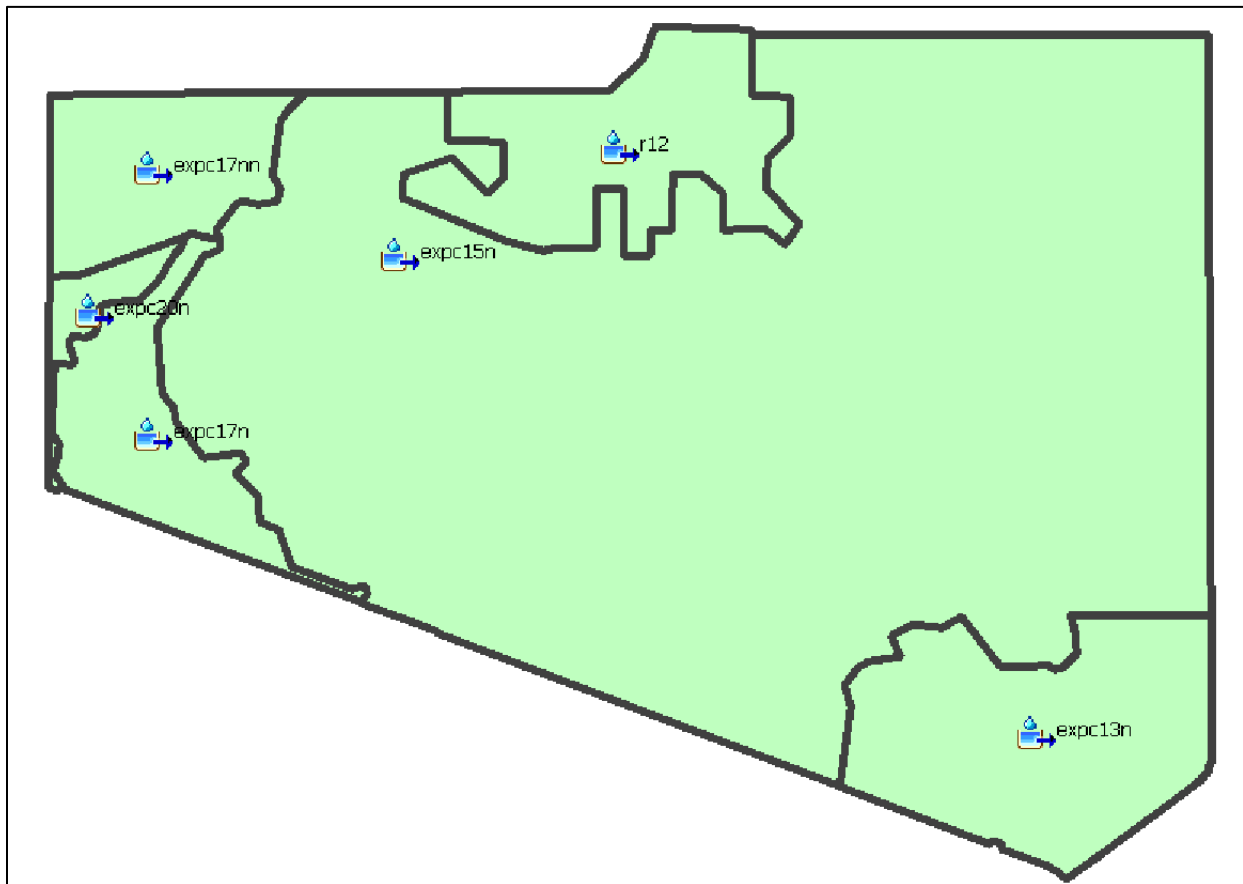


Figure 2. Existing Condition Model Basins within LOCAR Site.

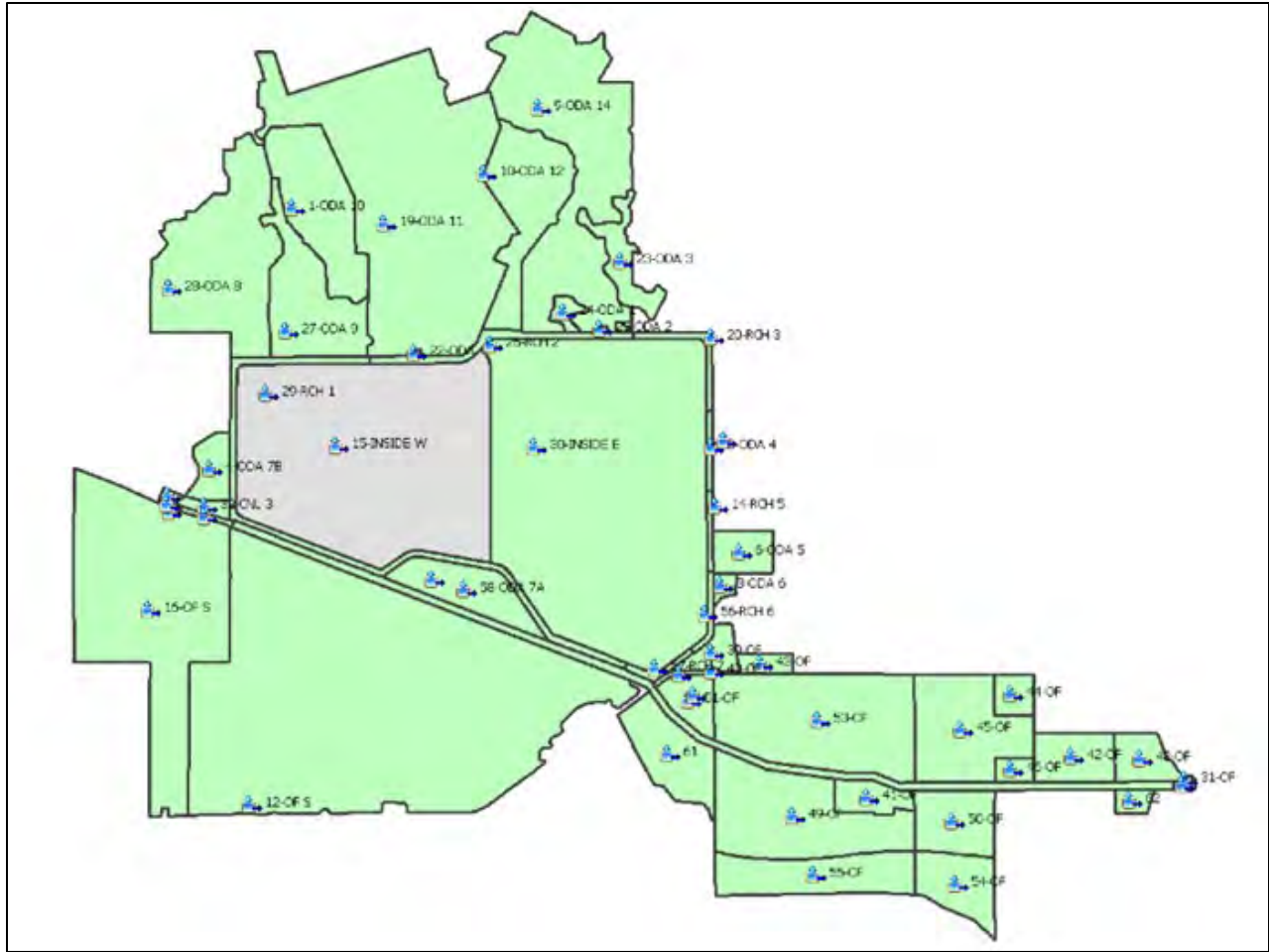


Figure 3. Proposed Condition Model Basins.

3.0 Storage

Storage in each basin was calculated using the 2018 Highlands County, bare-earth, DEM, obtained from the USGS LiDAR explorer website at: [USGS Lidar Explorer Map \(nationalmap.gov\)](https://nationalmap.gov); except for the reservoir perimeter canal and C-41A canal. In those basins the storage is based on the channel section. An image of the 2018 Highlands County DEM used to determine the storage for each basin is shown in **Figure 4**. HEC-RAS storage areas were used to represent the basins in the model. Because of the relatively flat topography, the basins will become inundated during the larger storm events.

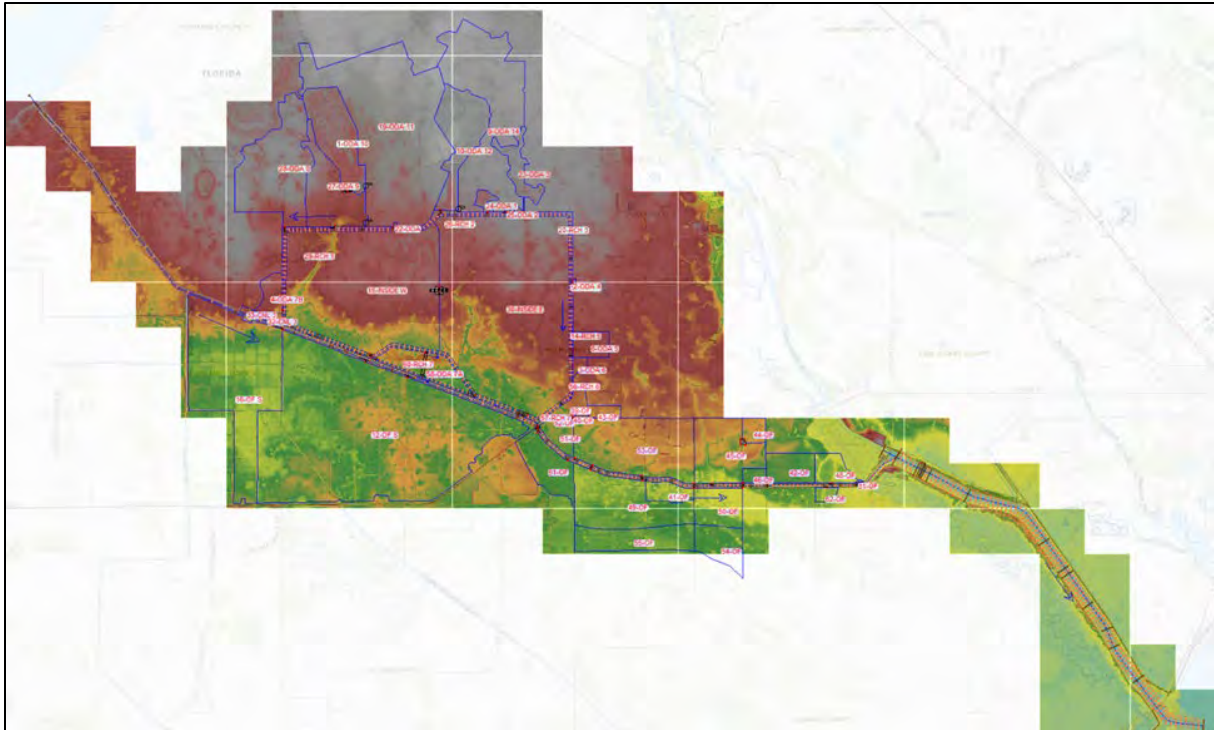


Figure 4. Proposed Condition Model Basins with 2018 Highlands County DEM.

4.0 Hydraulics

HEC-RAS 1-D models were developed for the existing and proposed drainage conditions. An existing system drainage model was developed, then modified to reflect the changes required because of the LOCAR project. Weirs, culverts, and channels were used to connect the basins in accordance with the existing and proposed water management features shown in **Figures 25, 26 and 27**. Basins outside of the reservoir site, which drain to the reservoir perimeter canal, were connected to the perimeter canal via weir structures (labeled as offsite overflow structures OOS-1 through OOS-8 on **Figures 26 and 27**). The C-41A canal from S-83 to the C-38 canal, and the C-38 canal from S-65 to Lake Okeechobee, were coded as river reaches in HEC-RAS. Basins were represented by storage areas. In the proposed condition model, the perimeter canal was coded as a river around the reservoir. Typical sections used for the canals are shown on **Figures 10 and 11**. Section geometry for the C-41A canal is provided in **Figures 19, 20 and 21**.

Existing Condition Model

Currently, the area of the proposed reservoir site drains from north to south, cascading through a series of basins controlled by culverts and weirs. Land uses within and around the reservoir site include citrus groves, pastures, and impoundments. Citrus tree roots are damaged by periods of inundation. To prevent tree damage from flooding, the citrus groves areas are drained by pumping at a rate of 4 inches per day into above ground impoundments (AGIs). The basins ODA 11 and ODA 14 are citrus groves (ODA is an acronym for offsite drainage area). Basins ODA 9, 10, 12 and 13 are AGIs that attenuate the flows from the pumped grove areas and discharge into pastures and flow ways downstream or south of the groves. These pastures areas then drain by gravity to the C-41A canal. Control structures and drainage basins were coded into the model as described in the Hutcheon report. Once the drainage reaches the north levee of C-41A, there are four project culverts along the north levee of C-41A that convey the stormwater into the C-41A. Flow through these project culverts is controlled by upstream weirs. Weirs were used to represent the basin to C-41A canal connections. Only the weirs upstream of the culverts were modeled in HEC-RAS.

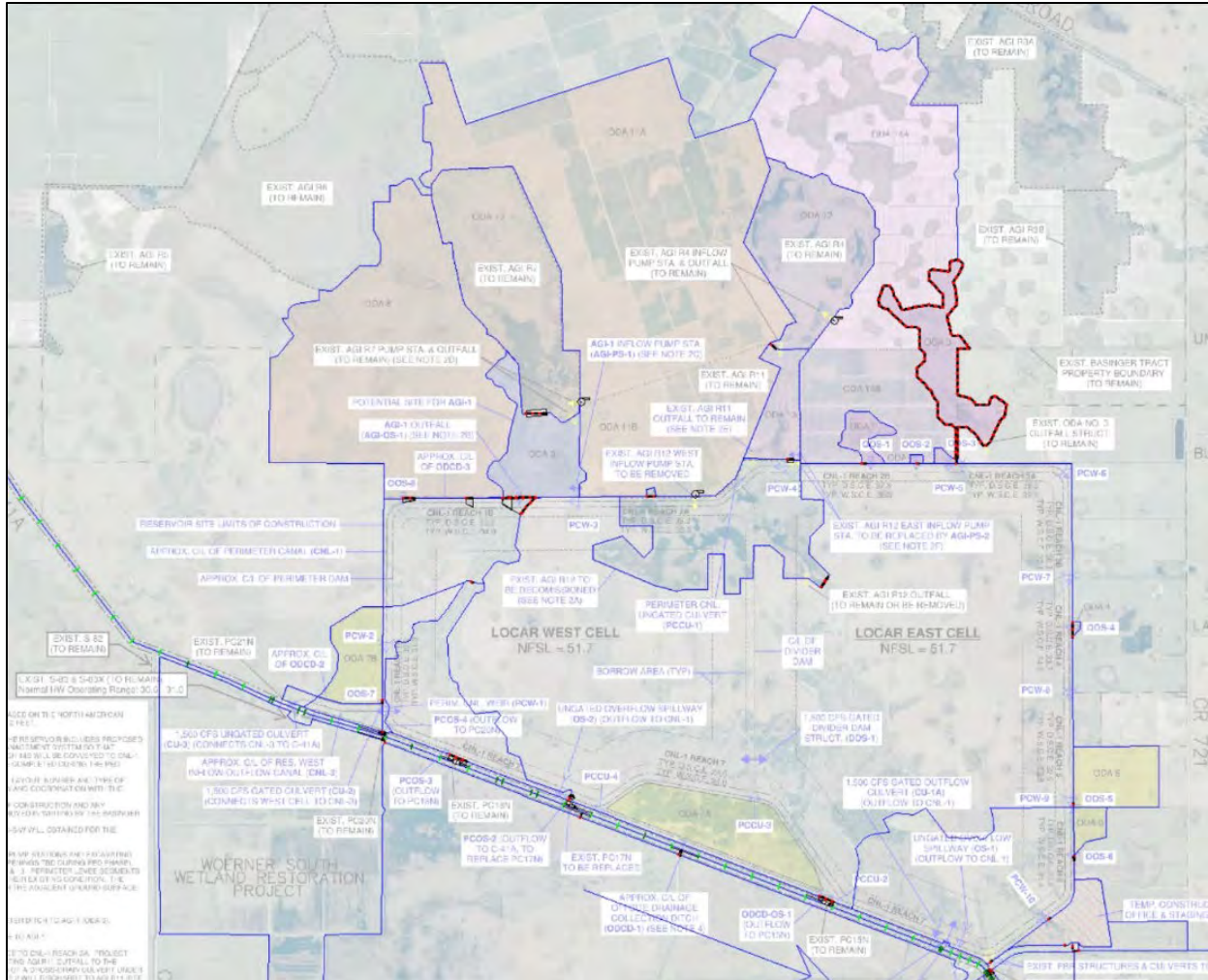


Figure 6. Existing Condition Model Basins Overlaid on Proposed LOCAR Footprint.

Proposed Condition Model

In the proposed condition model, the existing pastures and flow ways that convey stormwater south will be blocked by the reservoir footprint. As part of the LOCAR project, a perimeter canal will be constructed around the reservoir to convey seepage and stormwater runoff around the reservoir site to the C-41A canal. Flow through the proposed perimeter canal cascades from north to south along the east and west sides of the reservoir. A series of adjustable weirs maintain minimum water levels in the perimeter canal staging water levels down from north to south. For the proposed condition model simulations, the crest of each of these weirs were set to their typical seasonal low control elevation, shown on **Figures 26 and 27**. The perimeter canal parallels the C-41A canal along the south side of the reservoir and connects to the C-41A through existing project culverts overflow structures as shown in **Figures 26 and 27**. As shown in **Figure 27**, Existing AGI R12 located within the LOCAR downstream of ODA 13 and receiving pump water from ODA 11, will be eliminated as part of the LOCAR project. Water pumped from ODA 11 will be redirected to ODA 9, which will be modified to allow water to be pumped into this area.

The Reservoir East Inflow-Outflow canal (shown on **Figures 26 and 27**) will be used to convey water to LOCAR from C-41A during the filling and emptying processes. Weirs upstream of the project culverts were used to connect the perimeter canal to C-41A. Basins north of the LOCAR canal were connected to the perimeter

canal via weir structures. The configuration of these weir structures will need to be refined during the PED phase of the project.

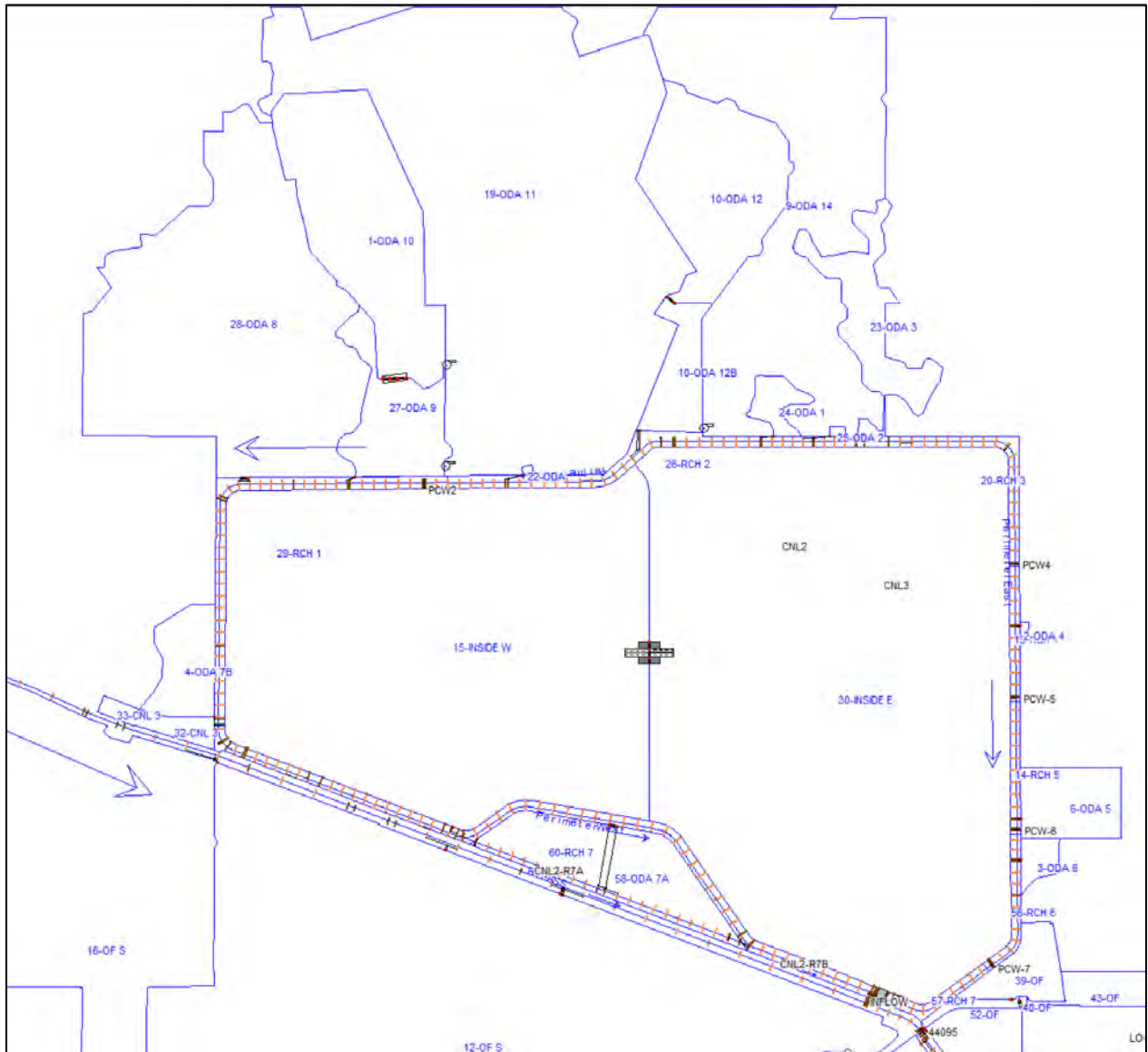


Figure 7. Proposed Condition Model Basins Within and Around the Reservoir Site.

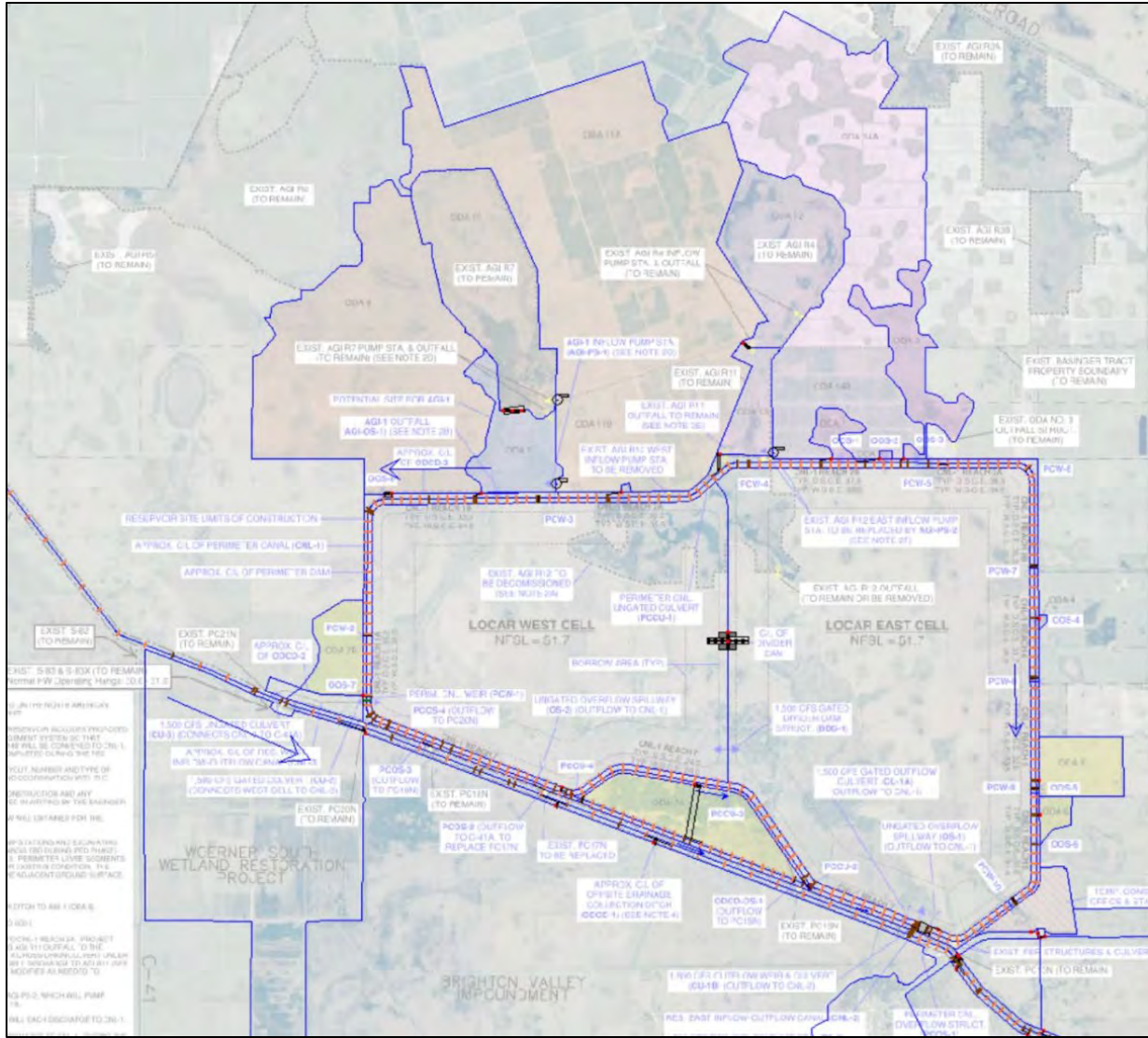


Figure 9. Proposed Condition Model Basins Overlaid on Proposed LOCAR Footprint.

5.0 Boundary Conditions

S-83 inflow was held constant at 3,830 cfs for the 10-year design storm and held constant at 4,150 cfs for the 100-year design storm. These flow rates for S-83 are consistent with the Corps design report for the C-41A Canal, titled Central and Southern Florida Project For Flood Control and Other Purposes, Part II, Kissimmee River Basin and Related Areas, Supplement 7 – Detail Design Memorandum Canal C-41A (Slough and Stub Canals) Structures 66, 68, 83 and 84, Serial No. 22, dated January 22, 1958. S-84/S-84+ was modeled with 3 gates based on the proposed improvements involving the replacement of S-84 with S-84+. Tailwater on S-84/S-84+ was based on stage in the C-38 Canal. S-84 was set to open when stages reached 23.9 and begin closings when stage were at 23.7 at a rate of 6 inches per minute. This structure operation schedule is consistent with the SFWMD published operation schedule for S-84. Lake Okeechobee was set at a constant stage of 18 feet NAVD for the duration of the simulations. S-65E was represented by a constant inflow of 2,590 cfs during the 10-year and 24,000 cfs during the 100-year events. These flows were used to estimate tailwater conditions for S-84/S-84+.

6.0 Routing

HEC-RAS simulations were conducted using “unsteady flow analysis” capability. Simulations represented a 5-day period, the first 3 days accounting for the storm and the remaining 2 days to capture peak stage and flows that may occur after the 3-day storm period. The 10-year and 100-year, 3-day storms were simulated. Rainfall hydrograph DSS files from HEC-HMS were linked to the HEC-RAS basins.

7.0 Results

The 10-year and 100-year, 3-day storm simulation results are provided in the **Tables 2 and 3**. Basins of interest are located north and east of the project site.

Table 3 shows that with the exception of basins ODA 5 and ODA 9, all peak stages for the basins in the proposed condition model 10-year and 100-year storm simulations are equal to or less than the peak stages for the same basins in the existing condition model 10-year and 100-year storm simulations. ODA 5 shows an increase in the peak stage from the existing condition model to the proposed condition model of 0.02 feet and 0.01 feet for the 10-year and 100-year simulations, respectively, which is a negligible increase in peak stage. Since ODA 9 represents an existing wetland area in the existing conditions model, while in the proposed condition model ODA 9 represents proposed above ground impoundment AGI-1 (as shown on **Figures 26 and 27**), it is expected that the peak stage will increase for ODA 9 in the proposed condition simulations.

Canal profiles for the C-41A canal and the LOCAR perimeter canal are provided in **Figures 12 through 18**.

8.0 Conclusion

Model results show the perimeter canal will have the capacity to pass the simultaneous reservoir seepage outflows (intercepted by the perimeter canal) and onsite and offsite stormwater flows (discharged to the perimeter canal) around the reservoir to C-41A without impacting the peak stage on these offsite basins.

The preliminary typical wet and dry season control elevations for each reach of CNL-1 is discussed in **Section A.9** and shown in **Figures 26 and 27**. As stated in the DPOM (**Annex C**), the crest elevation of one or more of the perimeter (seepage) canal adjustable weirs, PCW-1 through PCW-10, may need to be lowered within allowable limits, as part of CNL-1 operations before, during and after storm events, to maintain stages within CNL-1 that are sufficiently low enough to avoid adverse flooding during storm events, within the reservoir site and adjacent offsite properties which drain to CNL-1.

The proposed wet and dry season typical control elevations of the CNL-1 reaches, as well as the number and limits of the CNL-1 reaches may be adjusted during the PED phase of the project, as part of the additional 3D seepage modeling to be performed during the PED phase, as recommended in **Section A.9.4**. Additional H&H modeling will be required during the PED phase of the project to refine the offsite structure configurations that connect the perimeter canal to the adjacent offsite basins.

Table 2. Summary of Stages and Flows in C-41A for Existing and Proposed Condition Models.

Peak Water Surface Profile Conditions Simulated in the C-41A Canal			
Simulation	Total Flow (Q) (cfs)	Peak Water Surface Elevation (ft NAVD88)	Channel Velocity (ft/s)
Existing Condition Model - 10-year, 3-day Simulation			
Downstream S-83	3829	26.88	1.59
Upstream S70 Bridge	4540	26.04	1.99
Upstream S-84	5633	23.90	2.18
Proposed Condition Model - 10-year, 3-day Simulation			
Downstream S-83	3829	26.51	1.63
Upstream S70 Bridge	4325	25.84	1.92
Upstream S-84	5449	23.90	2.11
Existing Condition Model - 100-year, 3-day Simulation			
Downstream S-83	4149	28.11	1.59
Upstream S70 Bridge	5684	27.21	2.30
Upstream S-84	6619	24.72	2.44
Proposed Condition Model - 100-year, 3-day Simulation			
Downstream S-83	4148	27.27	1.67
Upstream S70 Bridge	4709	26.62	1.98
Upstream S-84	6305	24.41	2.37

Table 3. Summary of Stages and Flows in Subbasins for Existing and Proposed Condition Models.

ODA	Simulation	Peak Water Surface Elevation (ft NAVD 88)	Inflow (cfs)	Outflow (cfs)	HEC-RAS Storage Area ID	Existing Land Use (Proposed Land Use if different from Existing Land Use)
1	Exist 10y3d	39.70	0.00	26.17	24-ODA 1	Wetland
1	Prop 10y3d	39.50	22.34	0.00	24-ODA 1	Wetland
1	Exist 100y3d	39.78	0.00	44.02	24-ODA 1	Wetland
1	Prop 100y3d	39.50	36.02	0.00	24-ODA 1	Wetland
2	Exist 10y3d	40.15	0.00	10.73	25-ODA 2	Wetland
2	Prop 10y3d	40.00	84.93	0.00	25-ODA 2	Wetland
2	Exist 100y3d	40.22	0.00	18.02	25-ODA 2	Wetland
2	Prop 100y3d	40.00	105.45	0.00	25-ODA 2	Wetland
3	Exist 10y3d	40.42	0.00	32.87	23-ODA 3	Wetland
3	Prop 10y3d	39.50	37.34	0.00	23-ODA 3	Wetland
3	Exist 100y3d	40.71	0.00	60.51	23-ODA 3	Wetland
3	Prop 100y3d	39.58	60.57	0.00	23-ODA 3	Wetland

LOCAR Section 203 Feasibility Study Reservoir Perimeter Canal System Modeling



ODA	Simulation	Peak Water Surface Elevation (ft NAVD 88)	Inflow (cfs)	Outflow (cfs)	HEC-RAS Storage Area ID	Existing Land Use (Proposed Land Use if different from Existing Land Use)
4	Exist 10y3d	35.43	0.00	8.04	2-ODA 4	Wetland
4	Prop 10y3d	35.30	0.00	0.00	2-ODA 4	Wetland
4	Exist 100y3d	35.46	0.00	13.51	2-ODA 4	Wetland
4	Prop 100y3d	35.30	5.23	0.00	2-ODA 4	Wetland
5	Exist 10y3d	34.30	0.00	18.40	6-ODA 5	Pasture
5	Prop 10y3d	34.31	0.00	18.26	6-ODA 5	Pasture
5	Exist 100y3d	34.66	0.00	23.41	6-ODA 5	Pasture
5	Prop 100y3d	34.67	0.00	22.36	6-ODA 5	Pasture
6	Exist 10y3d	32.63	0.00	18.93	3-ODA 6	Pasture
6	Prop 10y3d	32.54	0.00	0.00	3-ODA 6	Pasture
6	Exist 100y3d	32.85	0.00	31.29	3-ODA 6	Pasture
6	Prop 100y3d	32.72	7.46	0.00	3-ODA 6	Pasture
7B	Exist 10y3d	30.31	0.00	155.38	4-ODA 7B	Pasture
7B	Prop 10y3d	29.87	0.00	0.00	4-ODA 7B	Pasture
7B	Exist 100y3d	30.54	0.00	250.86	4-ODA 7B	Pasture
7B	Prop 100y3d	30.37	0.00	0.00	4-ODA 7B	Pasture
8	Exist 10y3d	34.28	0.00	178.32	28-ODA 8	Pasture & Citrus Farm
8	Prop 10y3d	34.26	1349.24	0.00	28-ODA 8	Pasture & Citrus Farm
8	Exist 100y3d	34.99	0.00	208.22	28-ODA 8	Pasture & Citrus Farm
8	Prop 100y3d	34.90	2510.47	0.00	28-ODA 8	Pasture & Citrus Farm
9	Exist 10y3d	32.92	208.89	196.45	27-ODA 9	Wetland (AGI)
9	Prop 10y3d	36.79	349.42	0.00	27-ODA 9	Wetland (AGI)
9	Exist 100y3d	34.22	365.93	335.96	27-ODA 9	Wetland (AGI)
9	Prop 100y3d	37.33	577.39	0.00	27-ODA 9	Wetland (AGI)
10	Exist 10y3d	40.06	296.25	208.89	1-ODA 10	AGI
10	Prop 10y3d	40.06	296.25	208.42	1-ODA 10	AGI
10	Exist 100y3d	40.54	395.00	365.93	1-ODA 10	AGI
10	Prop 100y3d	40.54	395.00	365.89	1-ODA 10	AGI

LOCAR Section 203 Feasibility Study Reservoir Perimeter Canal System Modeling



ODA	Simulation	Peak Water Surface Elevation (ft NAVD 88)	Inflow (cfs)	Outflow (cfs)	HEC-RAS Storage Area ID	Existing Land Use (Proposed Land Use if different from Existing Land Use)
11	Exist 10y3d	38.36	0.00	296.25	19-ODA 11	Citrus Farm
11	Prop 10y3d	38.36	0.00	296.25	19-ODA 11	Citrus Farm
11	Exist 100y3d	39.55	0.00	395.00	19-ODA 11	Citrus Farm
11	Prop 100y3d	39.55	0.00	395.00	19-ODA 11	Citrus Farm
12	Exist 10y3d	44.25	180.00	148.52	10-ODA 12	AGI
12	Prop 10y3d	44.25	180.00	148.04	10-ODA 12	AGI
12	Exist 100y3d	44.57	240.00	230.28	10-ODA 12	AGI
12	Prop 100y3d	44.57	240.00	230.28	10-ODA 12	AGI
13	Exist 10y3d	40.43	148.52	142.55	10-ODA 12B	AGI
13	Prop 10y3d	39.80	232.04	0.00	10-ODA 12B	AGI
13	Exist 100y3d	40.66	230.28	228.42	10-ODA 12B	AGI
13	Prop 100y3d	39.80	314.28	0.00	10-ODA 12B	AGI
14	Exist 10y3d	41.63	0.00	180.00	9-ODA 14	Citrus Farm
14	Prop 10y3d	41.63	0.00	180.00	9-ODA 14	Citrus Farm
14	Exist 100y3d	42.58	0.00	240.00	9-ODA 14	Citrus Farm
14	Prop 100y3d	42.58	0.00	240.00	9-ODA 14	Citrus Farm
N/A	Exist 10y3d	26.60	18.93	419.46	expc13n	Pasture
N/A	Exist 100y3d	27.50	31.29	463.19	expc13n	Pasture
N/A	Exist 10y3d	30.36	419.74	258.51	expc15n	Pasture
N/A	Exist 100y3d	31.04	717.77	372.58	expc15n	Pasture
N/A	Exist 10y3d	30.20	597.00	0.00	expc17n	Pasture
N/A	Exist 100y3d	30.70	930.81	0.00	expc17n	Pasture
N/A	Exist 10y3d	32.20	374.77	338.49	expc17nn	Pasture
N/A	Exist 100y3d	33.48	544.18	558.23	expc17nn	Pasture
N/A	Exist 10y3d	27.77	316.17	0.00	expc20n	Pasture
N/A	Exist 100y3d	29.17	498.19	0.00	expc20n	Pasture
N/A	Exist 10y3d	37.81	367.55	323.53	r12	AGI
N/A	Exist 100y3d	38.25	523.93	558.30	r12	AGI

Table 4. SCS Method for Watershed Lag (per chapter 15 of National Engineering Handbook)

Basin ID	CN	Z ₁ (ft)	Z ₂ (ft)	Flow Length (ft)	Slope (%)	SCS Lag (hours)	SCS Lag (minutes)	T _c (hours)	Flow Velocity (fps)
1 - ODA 10	98	36.9	39.7	12938	0.02	8.0	479	13.3	0.27
2 - ODA 4	98	35.1	35.8	535	0.12	0.3	16	0.4	0.34
3 - ODA 6	90	31.5	34.2	2391	0.11	1.3	80	2.2	0.30
4 - ODA 7B	88	30.9	38.1	3800	0.19	1.6	97	2.7	0.39
6 - ODA 5	90	31.9	34.6	6978	0.04	5.3	318	8.8	0.22
9 - ODA 14	70	46.4	37.2	22359	0.04	25.1	1506	41.8	0.15
9 - ODA 14B	70	39.0	44.0	10155	0.05	12.2	732	20.3	0.14
10 - ODA 12	98	37.3	45.0	9394	0.08	3.2	190	5.3	0.50
10 - ODA 12B	98	37.4	40.8	4994	0.07	2.1	125	3.5	0.40
12 - OF S	91	25.0	27.0	20522	0.01	24.3	1458	40.5	0.14
13 - RCH 4	89	44.0	43.0	150	0.67	0.1	4	0.1	0.40
14 - RCH 5	88	44.0	43.0	150	0.67	0.1	4	0.1	0.39
15 - INSIDE W	98	0.0	0.0	5	0.00	0.0	0		
19 - ODA 11	68	37.5	48.5	21084	0.05	22.5	1350	37.5	0.16
19 - ODA 11B	68	43.3	36.8	14181	0.05	17.4	1046	29.1	0.14
20 - RCH 3	88	44.0	43.0	150	0.67	0.1	4	0.1	0.39
22 - ODA	98	36.0	39.5	320	1.09	0.1	3	0.1	0.92
23 - ODA 3	93	39.6	42.0	9961	0.02	7.9	475	13.2	0.21
24 - ODA 1	94	38.0	38.9	2894	0.03	2.5	149	4.1	0.19
25 - ODA 2	94	38.6	40.7	395	0.52	0.1	7	0.2	0.54
26 - RCH 2	93	44.0	43.0	150	0.67	0.1	3	0.1	0.48
27 - ODA 9	98	34.1	39.5	12032	0.04	5.2	314	8.7	0.38
28 - ODA 8	68	33.6	40.1	14324	0.05	17.6	1057	29.4	0.14
29 - RCH 1	87	44.0	43.0	150	0.67	0.1	4	0.1	0.37
30 - INSIDE E	98	0.0	0.0	0	0.00	0.0	0	0.0	0.00
35 - C41A	73.2	44.0	42.0	100	2.00	0.0	3	0.1	0.38
39 - OF	88	29.0	32.1	3828	0.08	2.5	149	4.1	0.26
40 - OF	87	31.0	32.0	150	0.67	0.1	4	0.1	0.37
41 - OF	88	23.4	26.1	5303	0.05	4.0	241	6.7	0.22
42 - OF	87	24.3	28.1	6966	0.05	5.1	304	8.4	0.23
43 - OF	92.5	30.0	32.6	6130	0.04	4.1	249	6.9	0.25
44 - OF	87.1	28.8	29.7	3831	0.02	4.6	279	7.7	0.14
45 - OF	85	23.3	30.6	6932	0.11	3.9	233	6.5	0.30
46 - OF	87	26.4	27.6	3986	0.03	4.4	263	7.3	0.15
48 - OF	88	23.7	24.0	2869	0.01	4.9	292	8.1	0.10
49 - OF	88	24.1	27.8	14439	0.03	12.7	763	21.2	0.19
50 - OF	88	21.7	27.5	8689	0.07	5.3	317	8.8	0.27
51 - OF	88	27.7	30.2	3828	0.06	2.8	168	4.7	0.23
52 - OF	87	28.3	29.6	3994	0.03	4.2	249	6.9	0.16
53 - OF	87	26.0	28.5	4609	0.05	3.7	221	6.1	0.21
54 - OF	87	21.7	27.5	8689	0.07	5.5	329	9.1	0.26
55 - OF	88	24.1	27.8	14439	0.03	12.7	763	21.2	0.19
56 - RCH 6	87	44.0	43.0	150	0.67	0.1	4	0.1	0.37
57 - RCH 7	90	44.0	43.0	150	0.67	0.1	4	0.1	0.42
58 - ODA 7A	89	25.3	29.4	8426	0.05	5.8	349	9.7	0.24
59 - C41A	77	2.0	0.0	150	1.33	0.1	4	0.1	0.38

Basin ID	CN	Z_1 (ft)	Z_2 (ft)	Flow Length (ft)	Slope (%)	SCS Lag (hours)	SCS Lag (minutes)	T _c (hours)	Flow Velocity (fps)
60 - RCH 7	91	44.0	43.0	150	0.67	0.1	3	0.1	0.44
61	87	22.6	26.5	8379	0.05	6.4	382	10.6	0.22
62	87	23.9	25.7	1386	0.13	0.9	54	1.5	0.26
r12	88.0	36.2	37.0	10382	0.01	11.2	669	18.6	0.16
expc13n	88.0	27.3	30.8	7522	0.05	5.6	337	9.4	0.22
expc15n	88.0	26.8	36.3	22598	0.04	14.3	856	23.8	0.26
expc17n	88.0	23.5	32.0	9116	0.09	4.6	278	7.7	0.33
expc17nn	88.0	30.5	34.9	7248	0.06	4.8	287	8.0	0.25
expc20n	88.0	33.6	34.3	4506	0.02	6.5	388	10.8	0.12

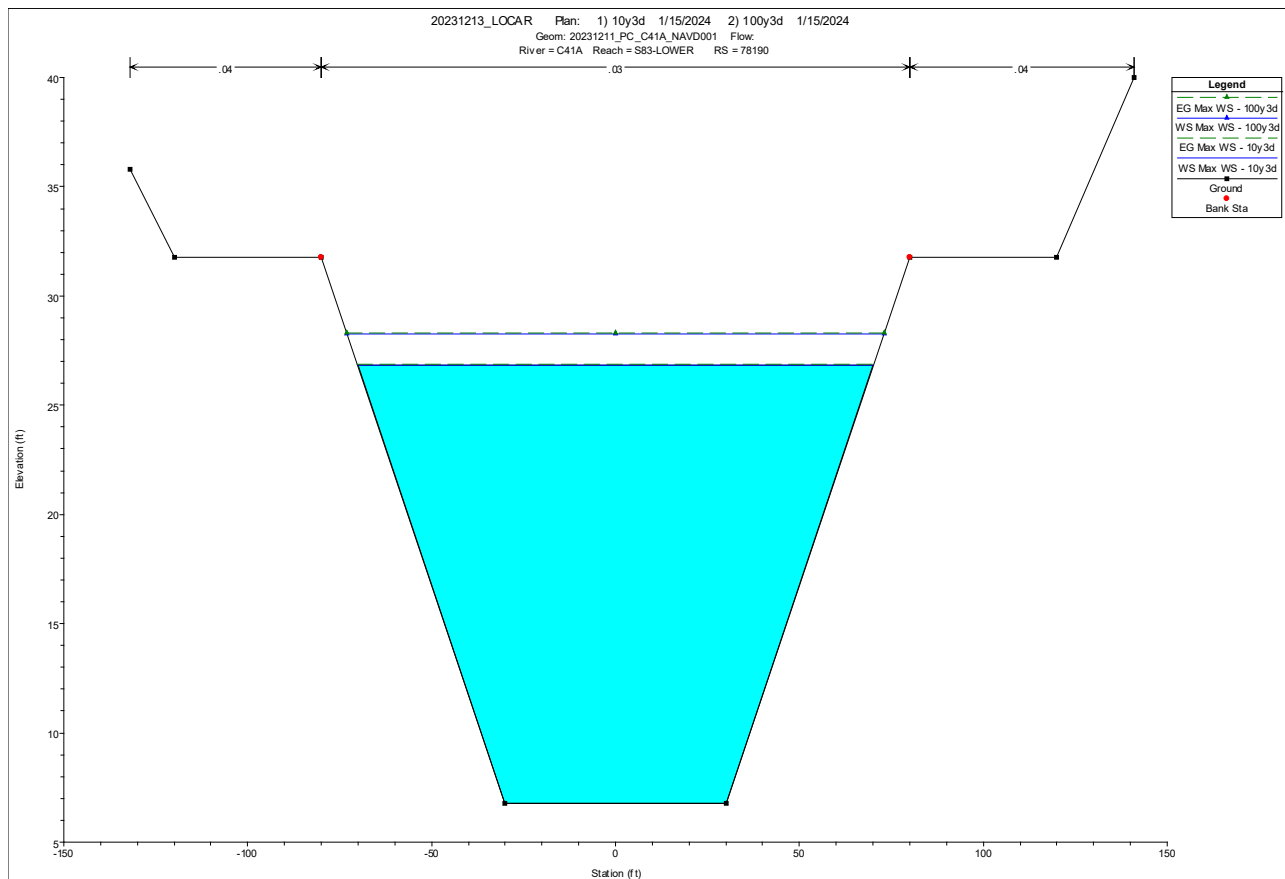


Figure 10. Typical Canal Section used for the C-41A Canal.

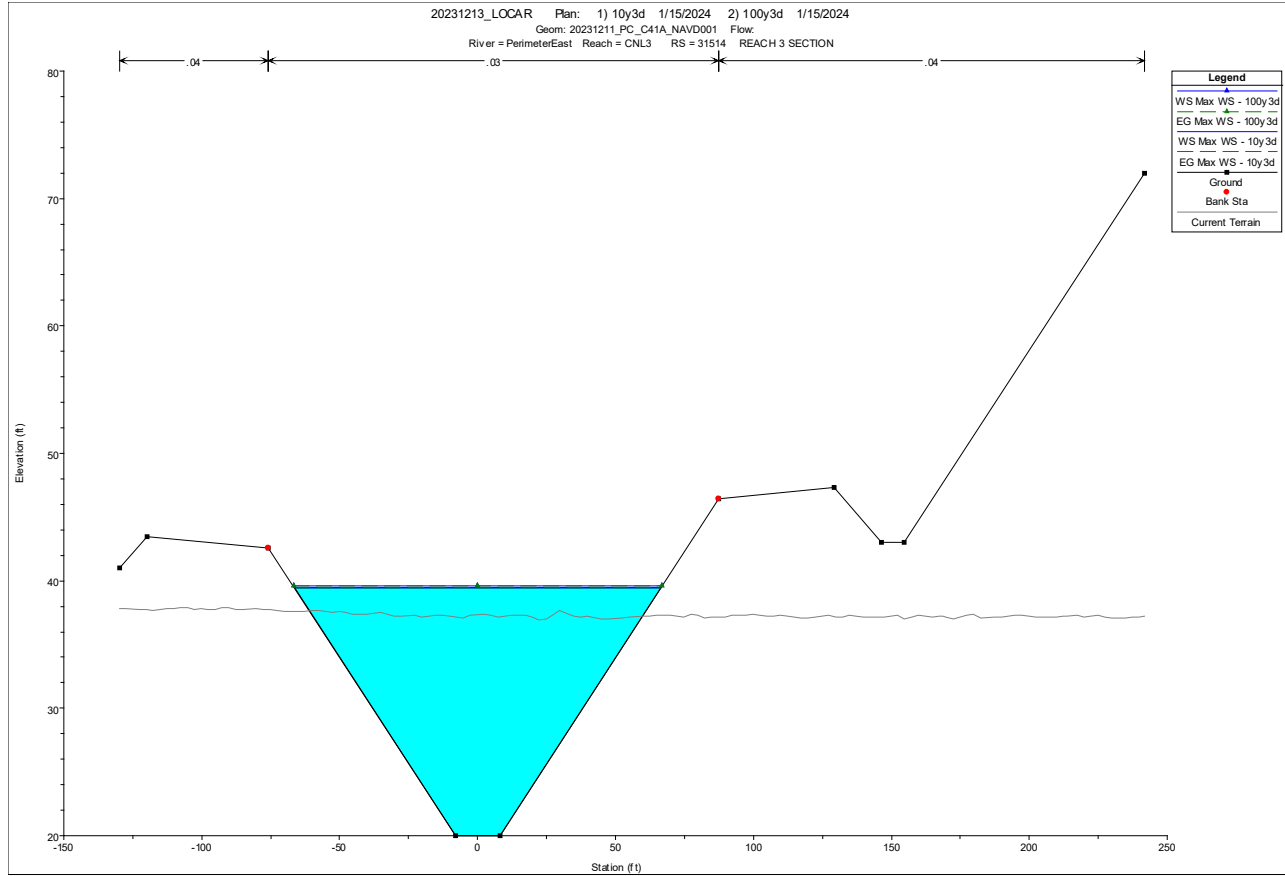


Figure 11. Typical Canal Section used for the LOCAR Perimeter Canal.

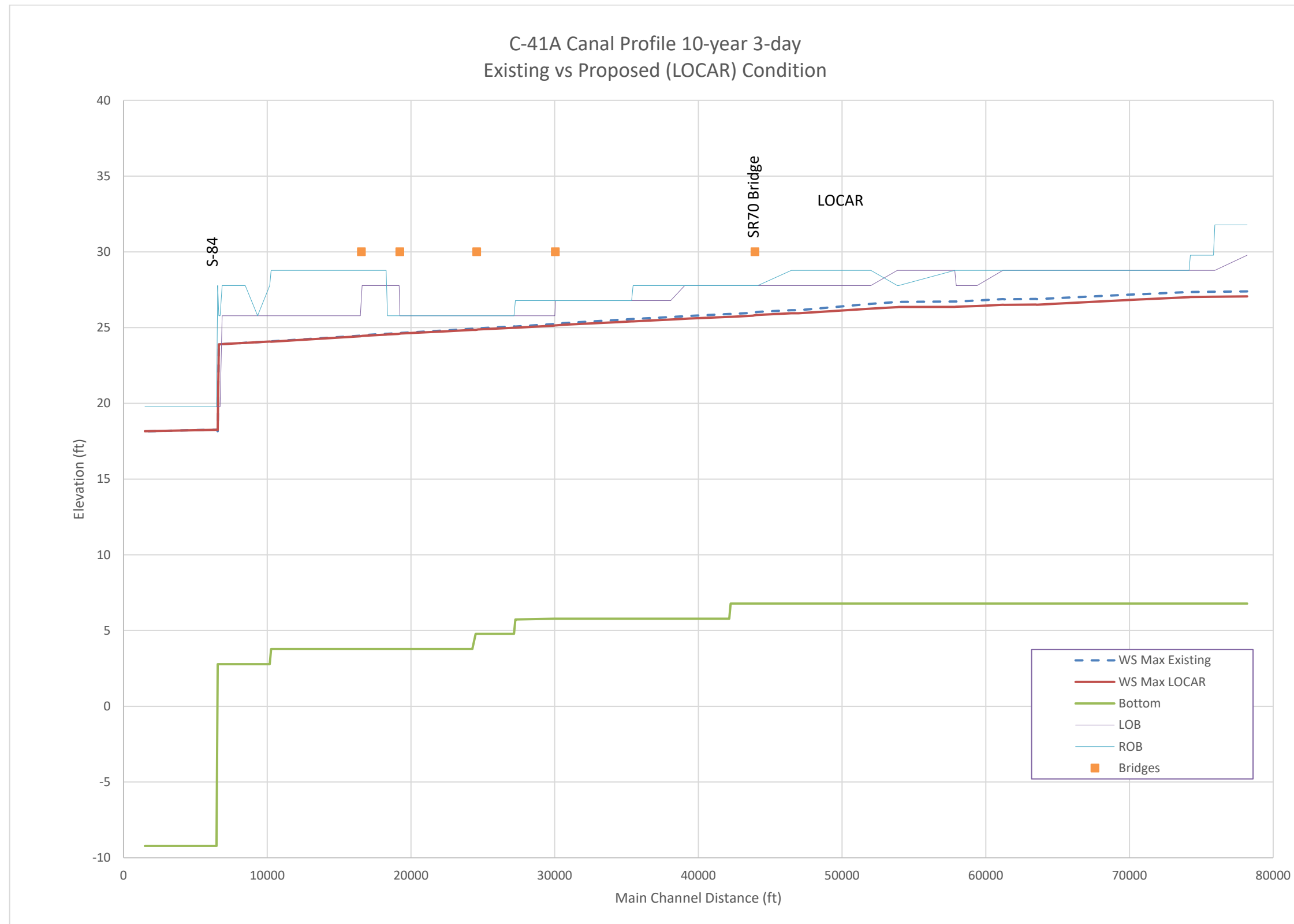


Figure 12. C-41A Water Surface Profile Comparison Between Existing and Proposed (LOCAR) Condition for 10-Year, 3-Day Storm.

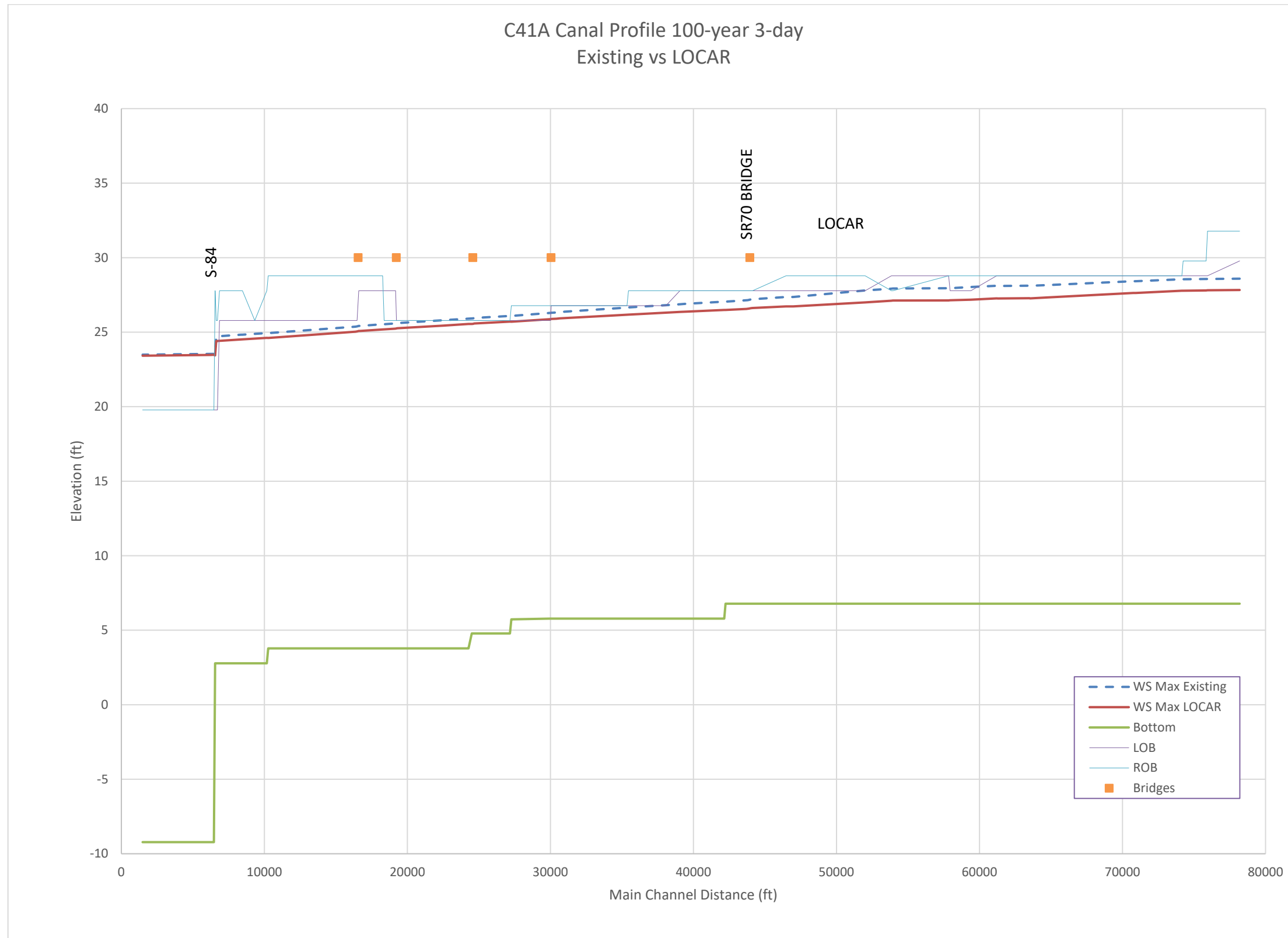


Figure 13. C-41A Water Surface Profile Comparison Between Existing and Proposed (LOCAR) Condition for 100-Year, 3-Day Storm.

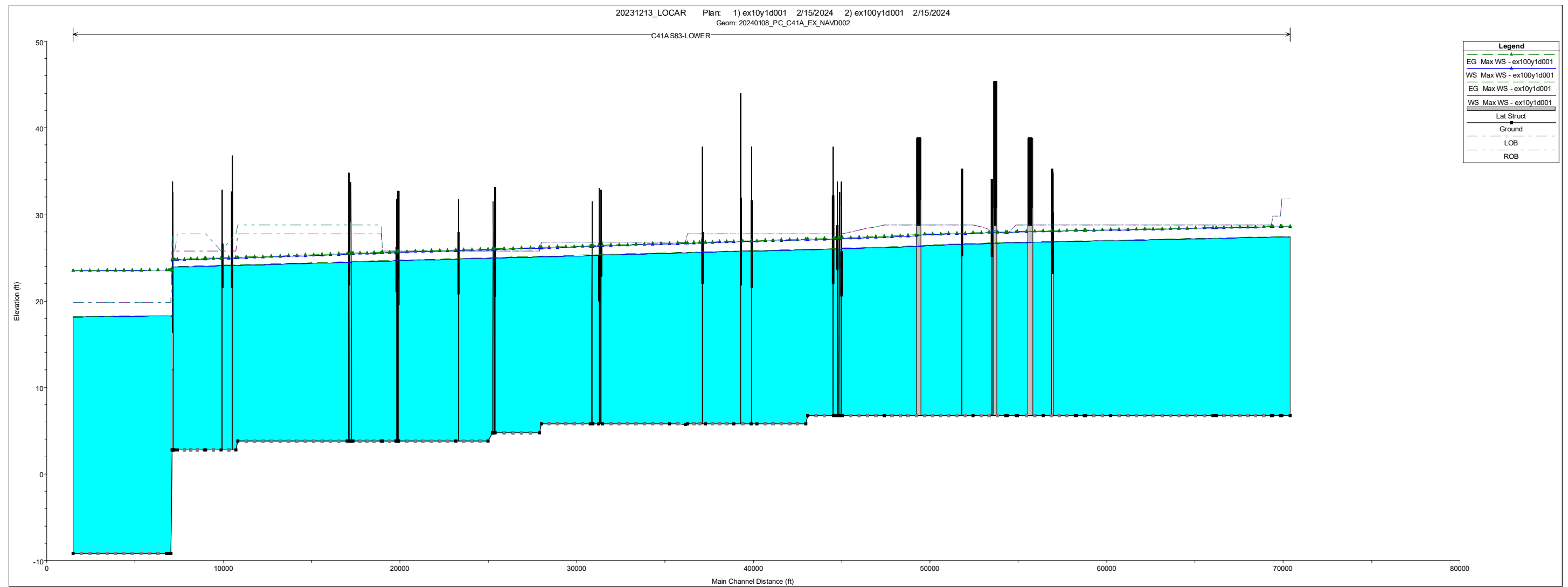


Figure 14. C-41A Canal Maximum Water Surface Profile for Existing Conditions.

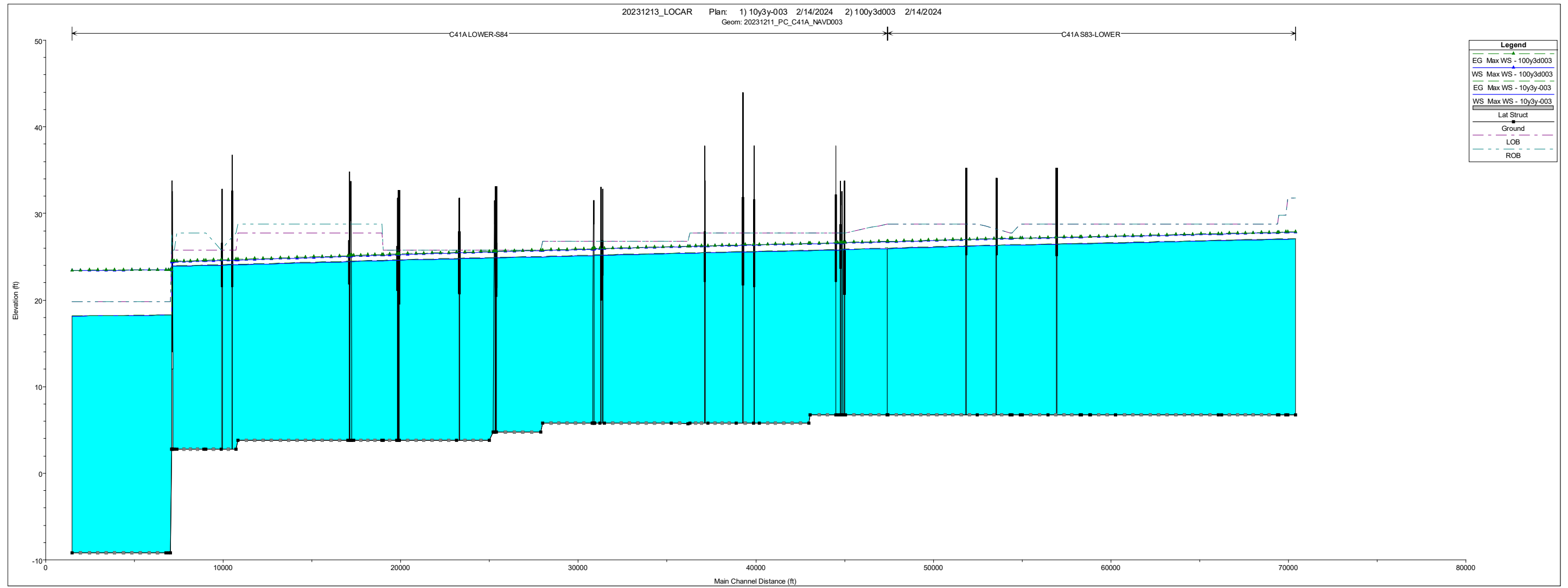


Figure 15. C-41A Canal Maximum Water Surface Profile for Proposed Conditions.

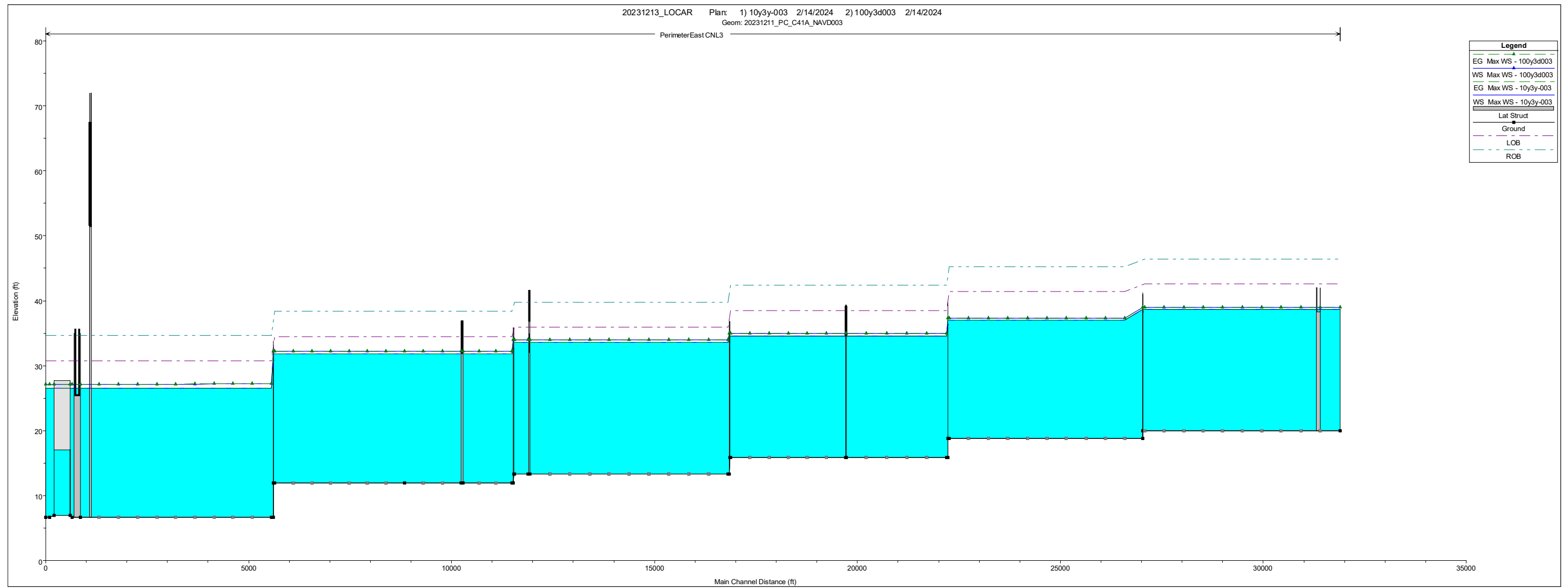


Figure 16. LOCAR Perimeter Canal East Side Maximum Water Surface.

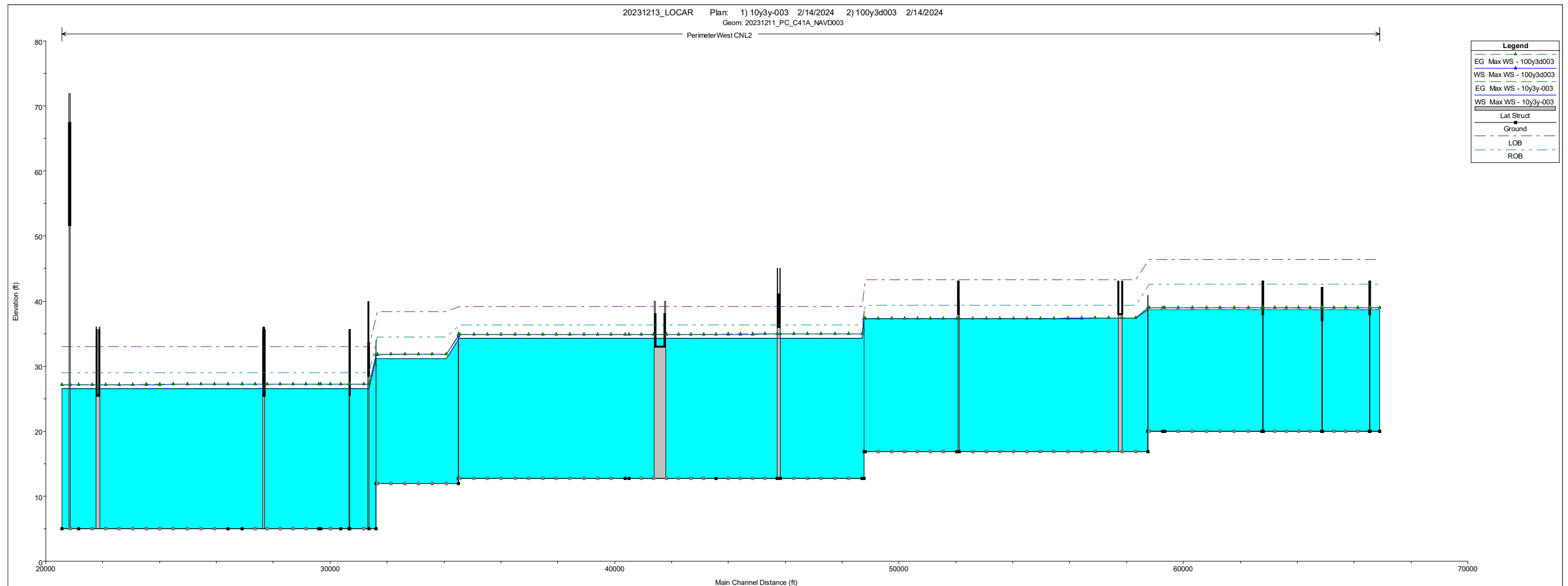


Figure 17. LOCAR Perimeter Canal West Side Maximum Water Surface.

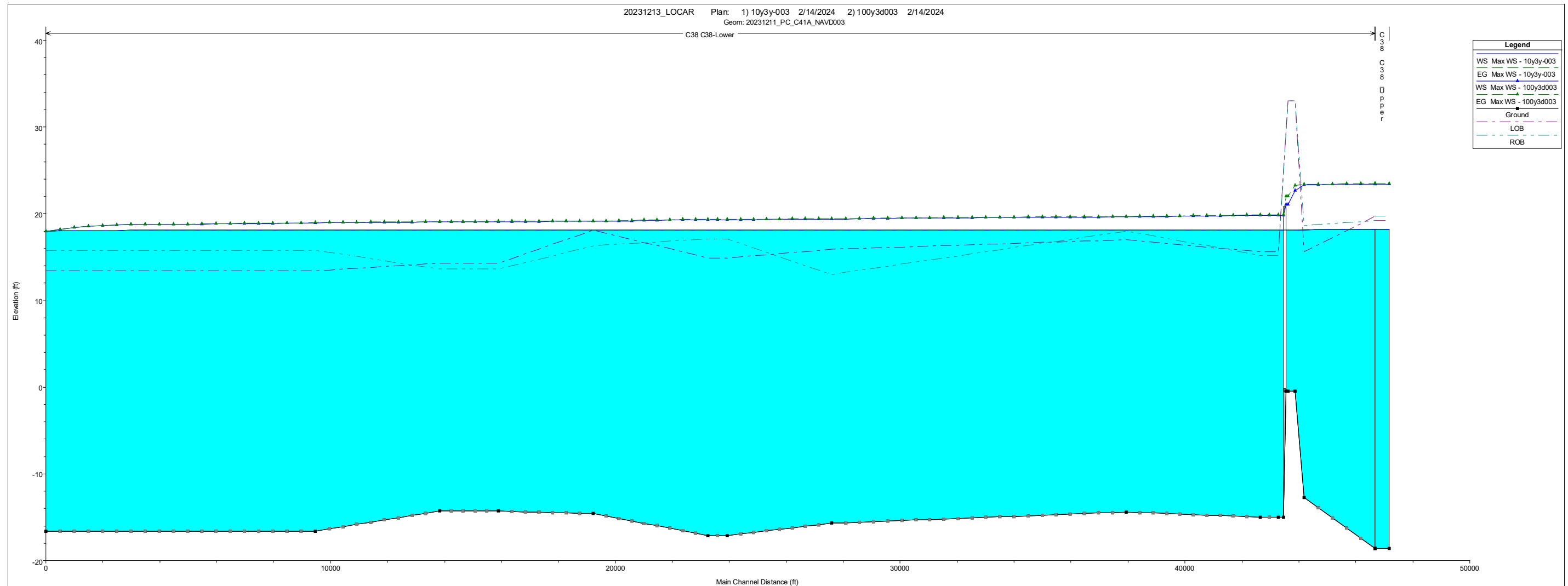


Figure 18. C-38 Canal Profile Maximum Water Surface.

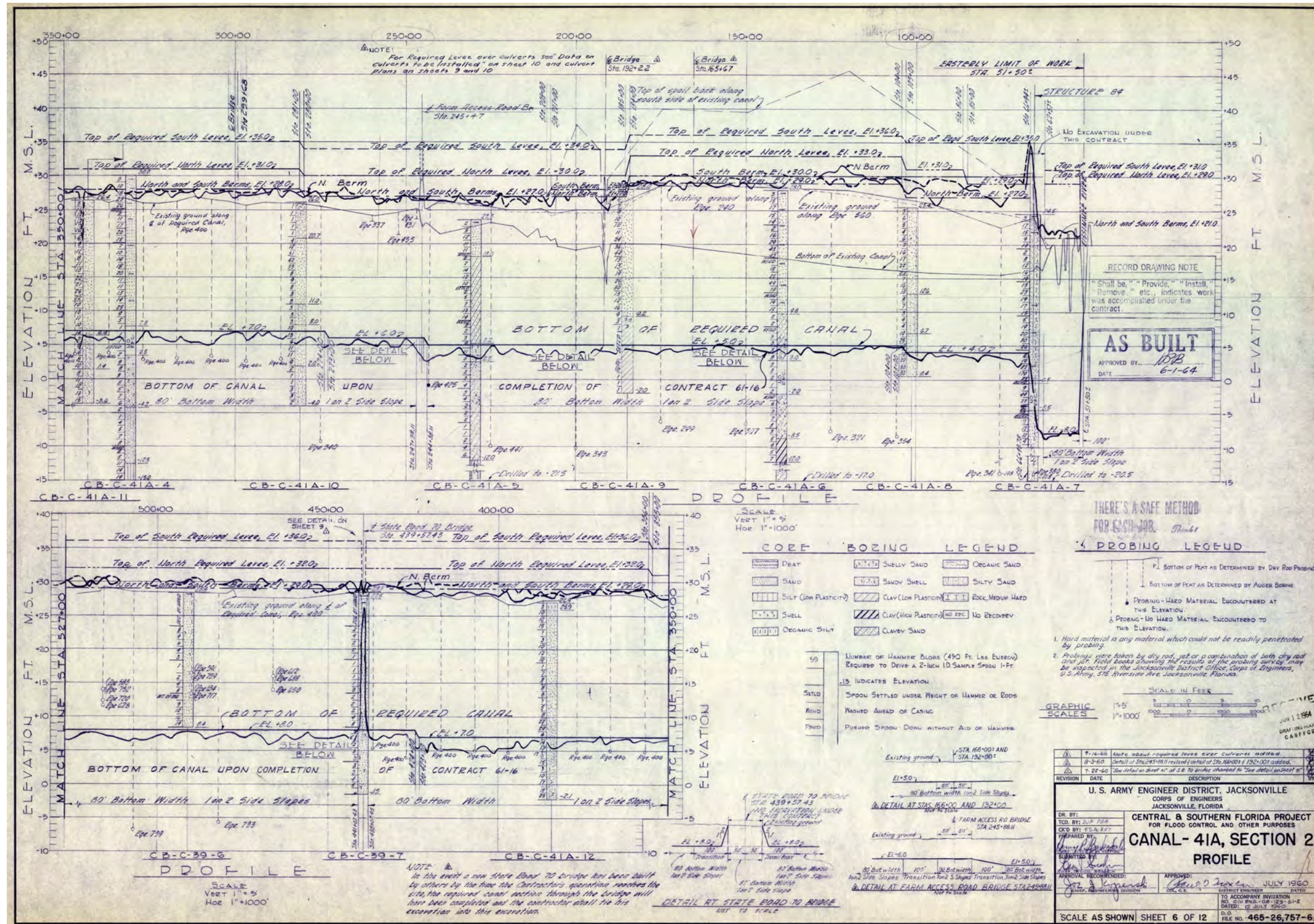


Figure 19. C-41A Record Drawing with Section Dimensions.

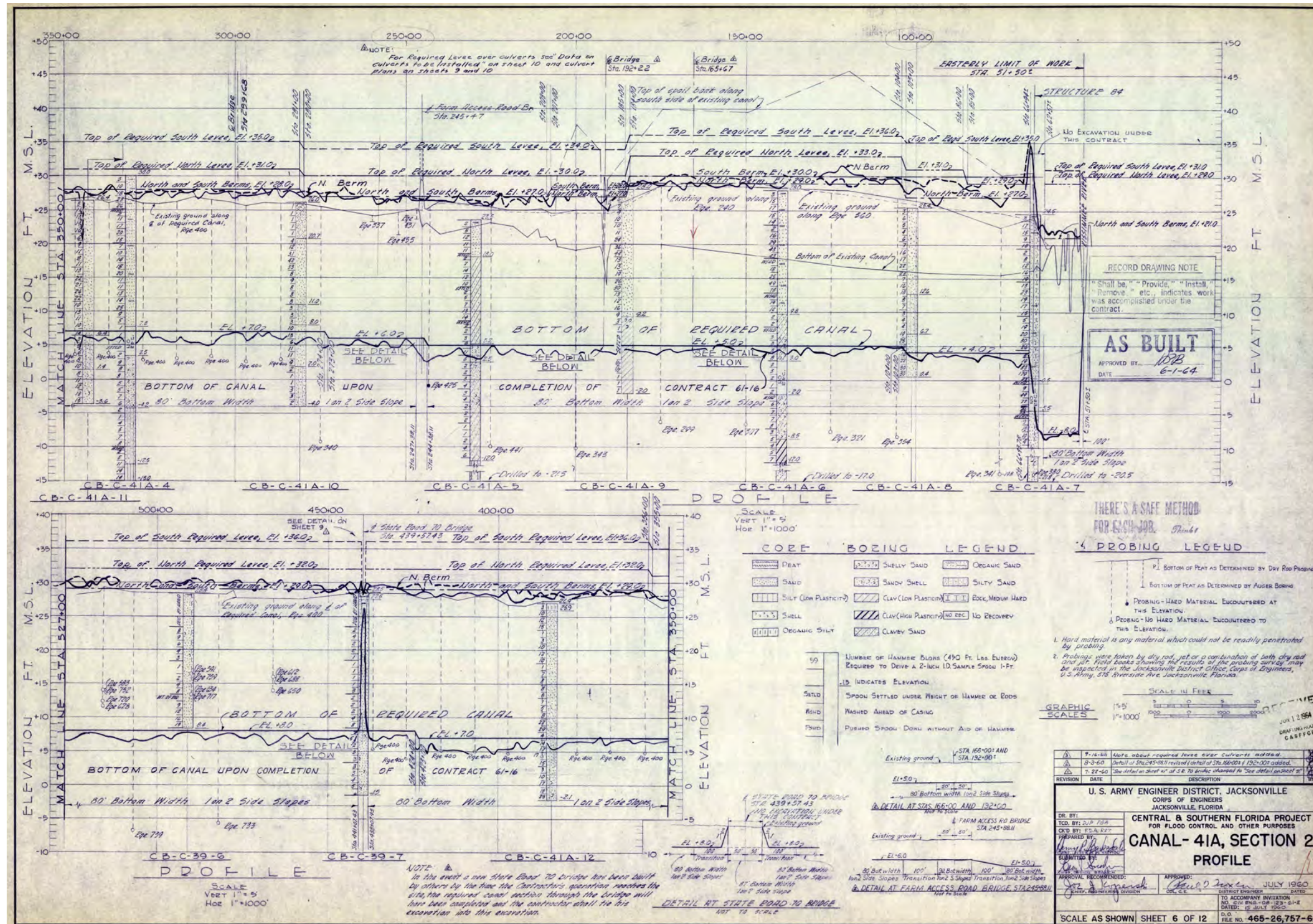


Figure 20. C-41A Record Drawing with Section Dimensions.

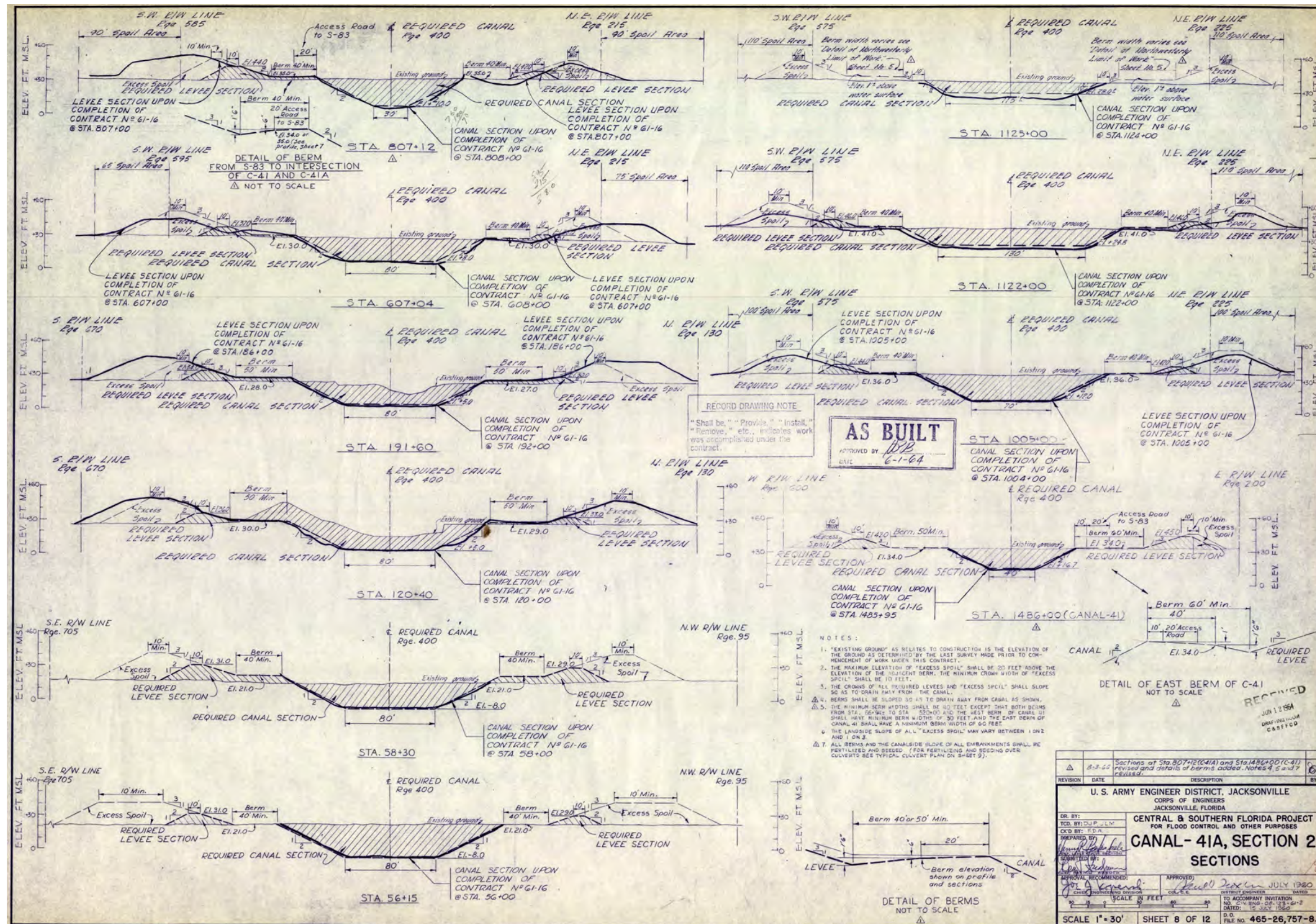


Figure 21. C-41A Record Drawing Section Dimensions.

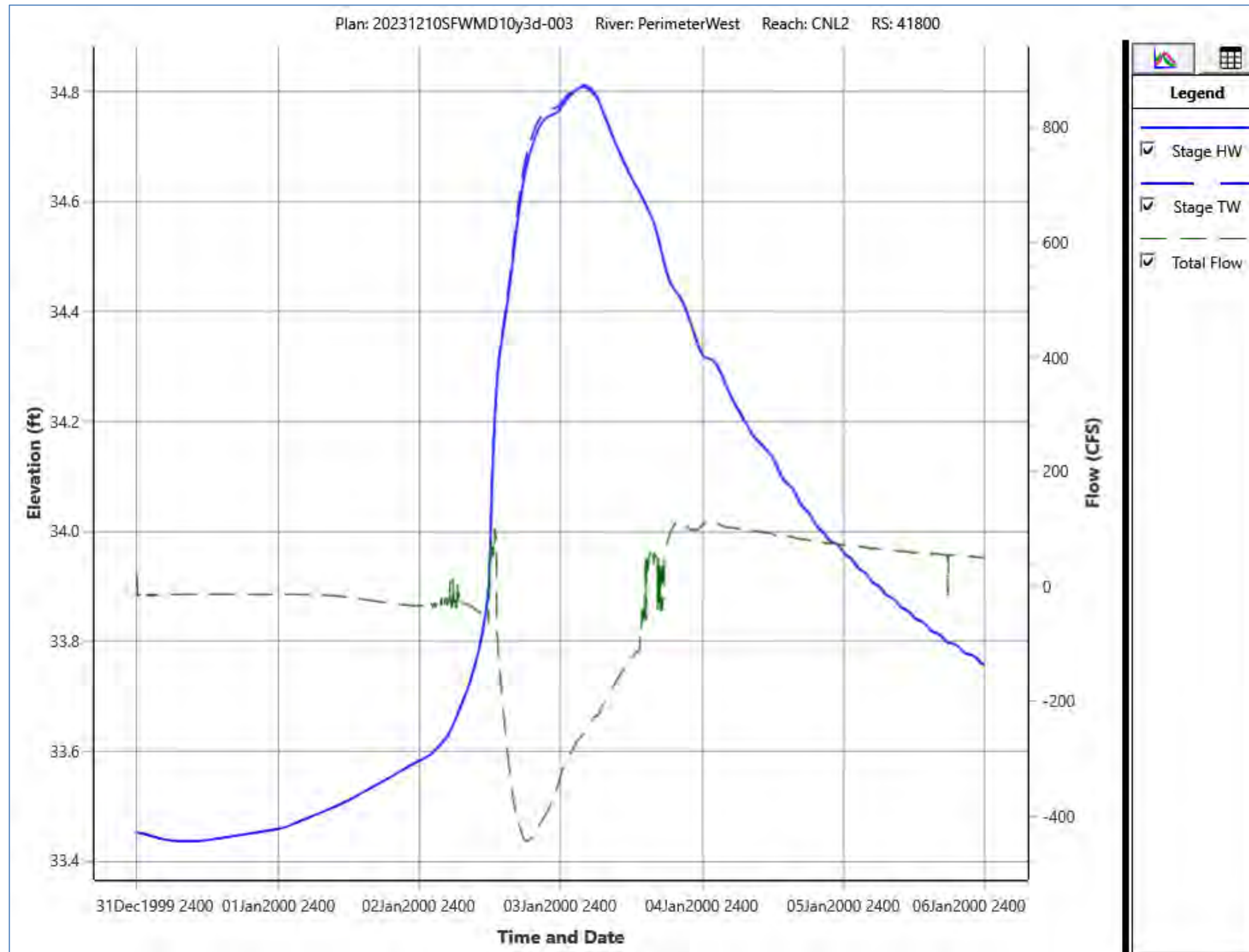


Figure 22. Stage and Discharge from ODA 8 into Perimeter Canal for 10-year 3-day storm (negative flow indicates flow into canal).

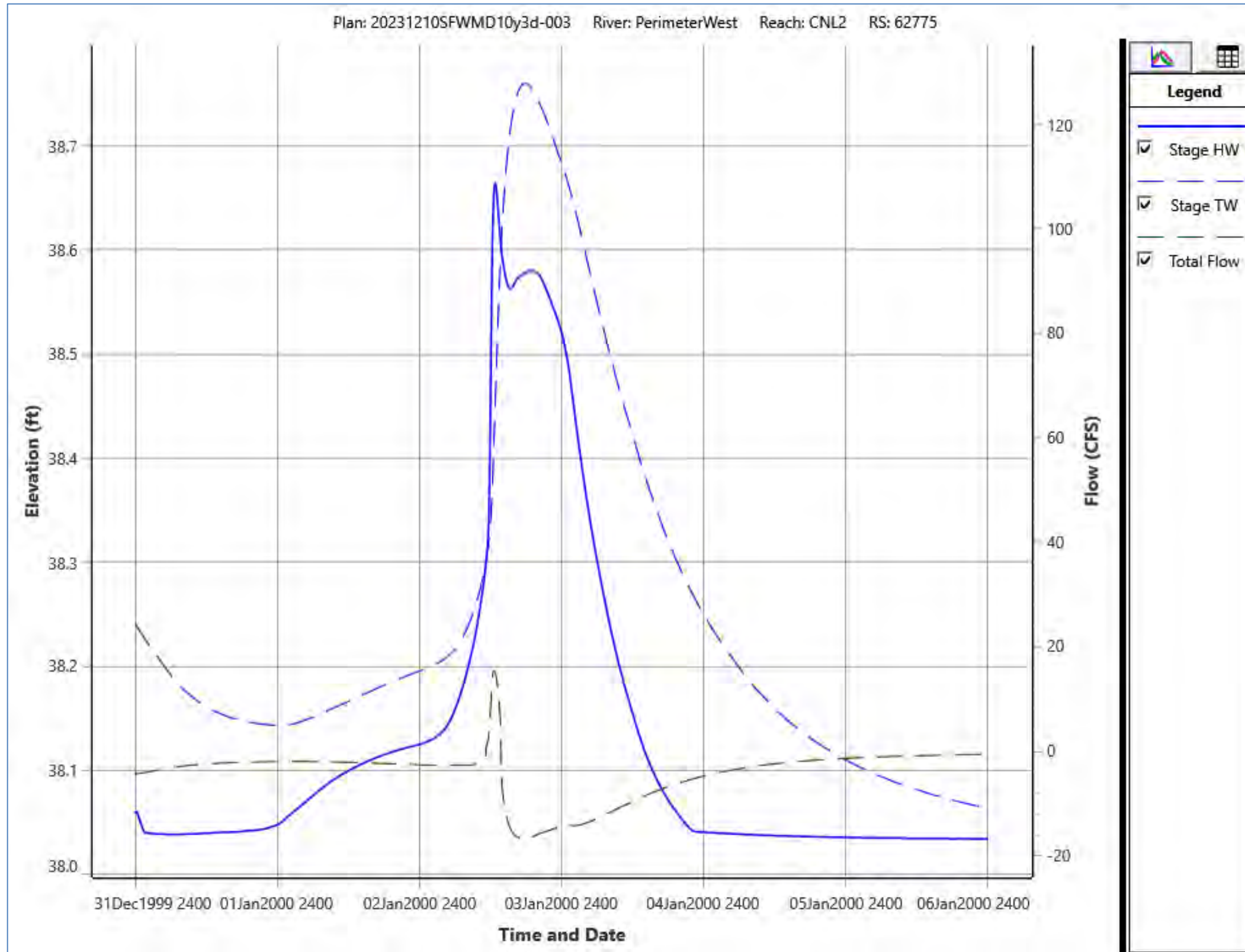


Figure 23. Stage and Discharge from 24-ODA 1 into the Perimeter Canal for 10-year 3-day storm.

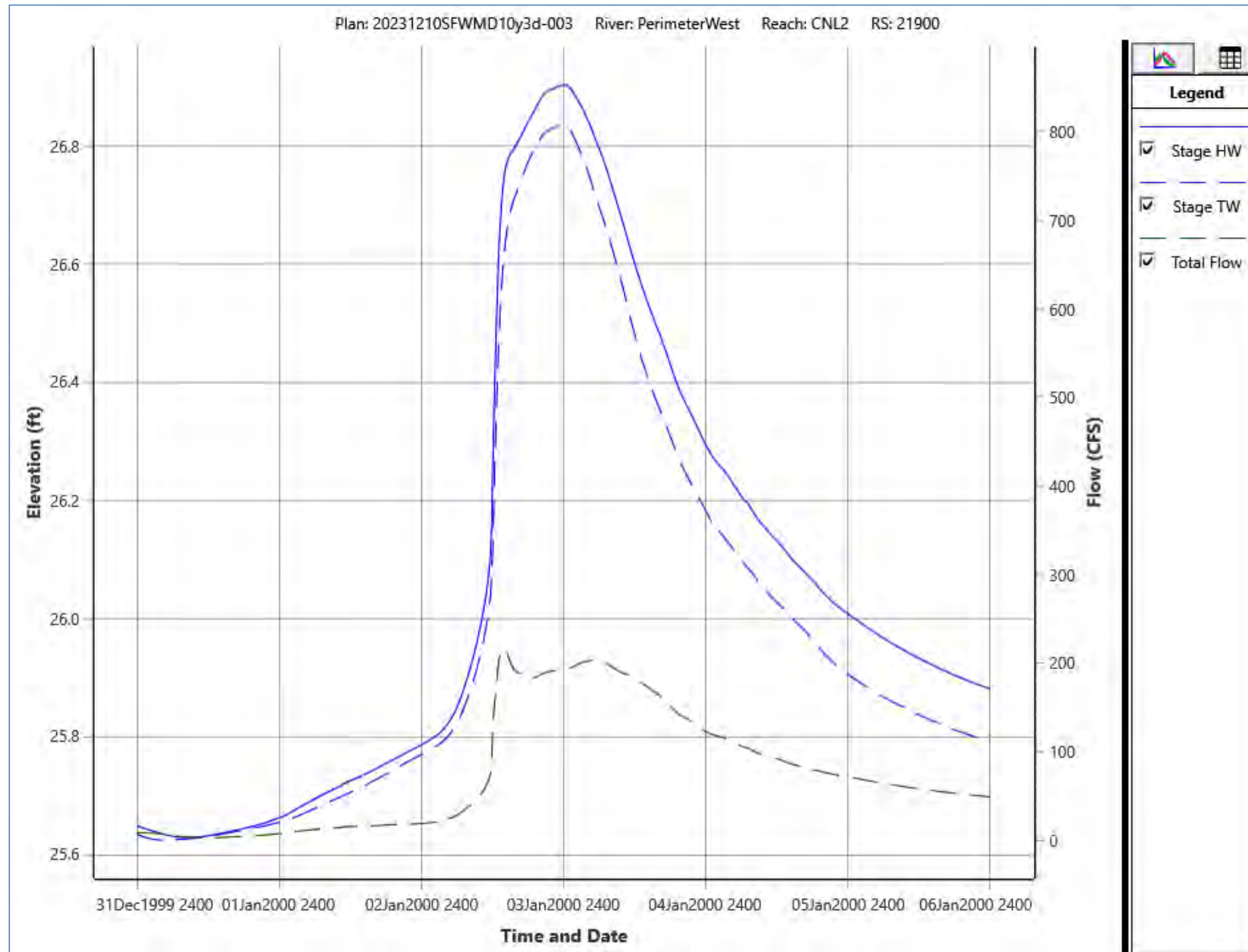


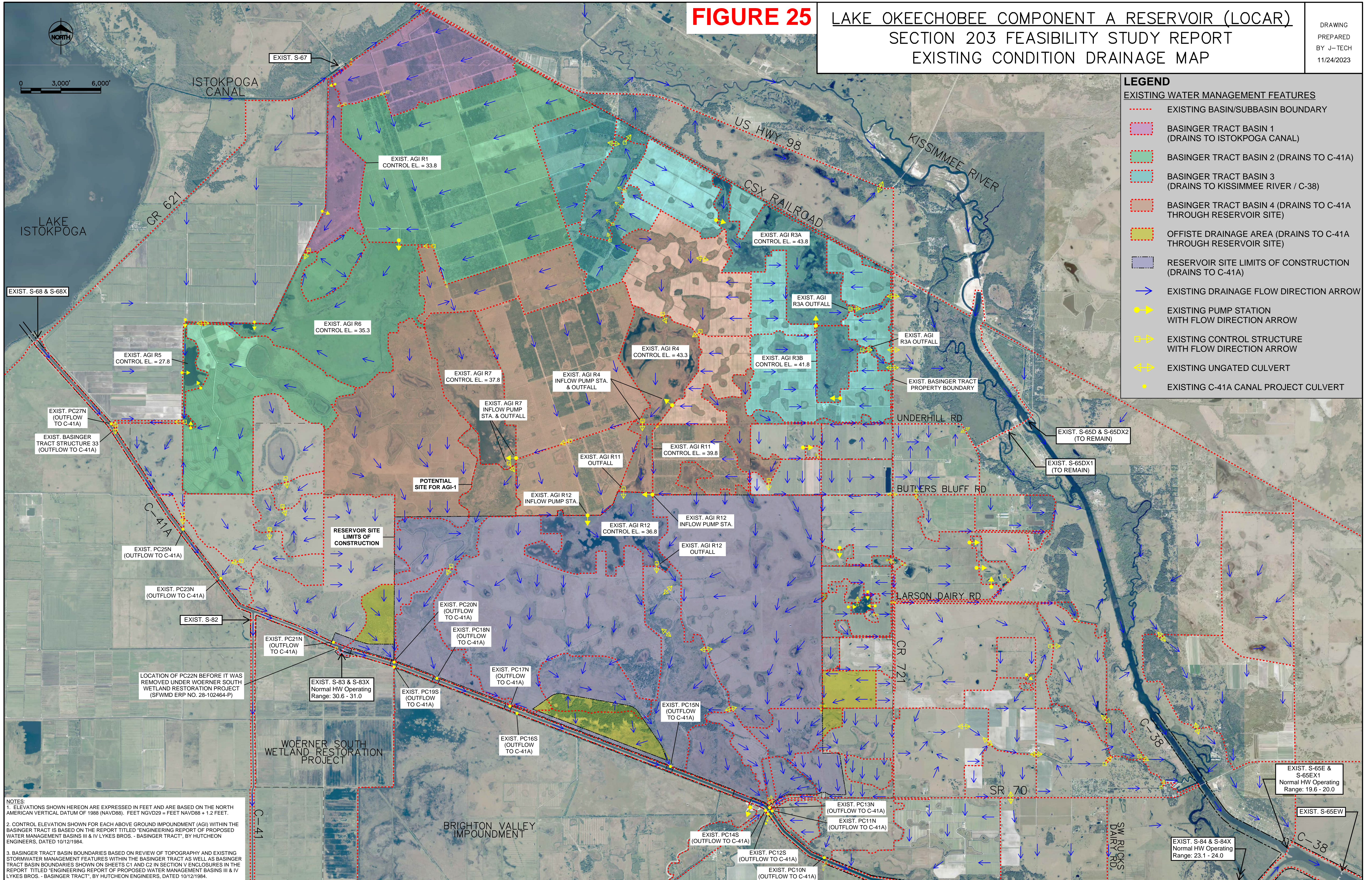
Figure 24. Stage and Discharge from Perimeter Canal into the C41A Canal for 10-year 3-day Storm.

Attached
Figures 25, 26 and 27

FIGURE 25

**LAKE OKEECHOBEE COMPONENT A RESERVOIR (LOCAR)
SECTION 203 FEASIBILITY STUDY REPORT
EXISTING CONDITION DRAINAGE MAP**

DRAWING
PREPARED
BY J-TECH
11/24/2023



LEGEND

EXISTING WATER MANAGEMENT FEATURES

- - - EXISTING BASIN/SUBBASIN BOUNDARY
- - - BASINGER TRACT BASIN 1 (DRAINS TO ISTOKPOGA CANAL)
- - - BASINGER TRACT BASIN 2 (DRAINS TO C-41A)
- - - BASINGER TRACT BASIN 3 (DRAINS TO KISSIMMEE RIVER / C-38)
- - - BASINGER TRACT BASIN 4 (DRAINS TO C-41A THROUGH RESERVOIR SITE)
- - - OFFSITE DRAINAGE AREA (DRAINS TO C-41A THROUGH RESERVOIR SITE)
- - - RESERVOIR SITE LIMITS OF CONSTRUCTION (DRAINS TO C-41A)
- EXISTING DRAINAGE FLOW DIRECTION ARROW
- EXISTING PUMP STATION WITH FLOW DIRECTION ARROW
- ⊠ EXISTING CONTROL STRUCTURE WITH FLOW DIRECTION ARROW
- ⚡ EXISTING UNGATED CULVERT
- EXISTING C-41A CANAL PROJECT CULVERT

NOTES

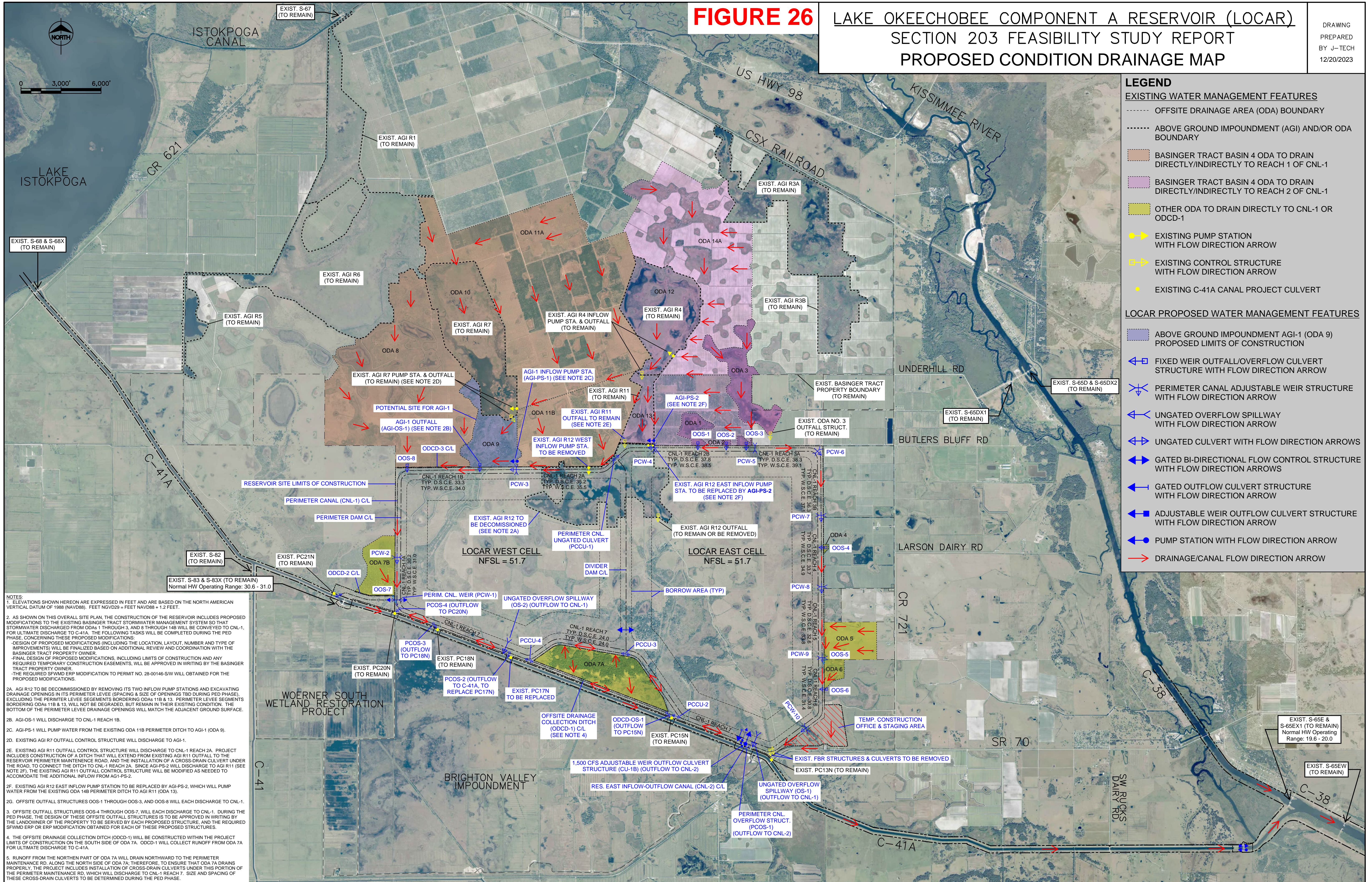
1. ELEVATIONS SHOWN HEREON ARE EXPRESSED IN FEET AND ARE BASED ON THE NORTH AMERICAN VERTICAL DATUM OF 1988 (NAVD88). FEET NGVD29 = FEET NAVD88 + 1.2 FEET.
2. CONTROL ELEVATION SHOWN FOR EACH ABOVE GROUND IMPOUNDMENT (AGI) WITHIN THE BASINGER TRACT IS BASED ON THE REPORT TITLED "ENGINEERING REPORT OF PROPOSED WATER MANAGEMENT BASINS III & IV LYKES BROS. - BASINGER TRACT", BY HUTCHISON ENGINEERS, DATED 10/12/1984.
3. BASINGER TRACT BASIN BOUNDARIES BASED ON REVIEW OF TOPOGRAPHY AND EXISTING STORMWATER MANAGEMENT FEATURES WITHIN THE BASINGER TRACT AS WELL AS BASINGER TRACT BASIN BOUNDARIES SHOWN ON SHEETS C1 AND C2 IN SECTION V ENCLOSURES IN THE REPORT TITLED "ENGINEERING REPORT OF PROPOSED WATER MANAGEMENT BASINS III & IV LYKES BROS. - BASINGER TRACT", BY HUTCHISON ENGINEERS, DATED 10/12/1984.

© 2023 J-TECH ENGINEERING, INC. ALL RIGHTS RESERVED. PROJECT NO. 23-001 - 10-2023

FIGURE 26

LAKE OKEECHOBEE COMPONENT A RESERVOIR (LOCAR) SECTION 203 FEASIBILITY STUDY REPORT PROPOSED CONDITION DRAINAGE MAP

DRAWING PREPARED BY J-TECH 12/20/2023



LEGEND

EXISTING WATER MANAGEMENT FEATURES

- OFFSITE DRAINAGE AREA (ODA) BOUNDARY
- ABOVE GROUND IMPOUNDMENT (AGI) AND/OR ODA BOUNDARY
- BASINGER TRACT BASIN 4 ODA TO DRAIN DIRECTLY/INDIRECTLY TO REACH 1 OF CNL-1
- BASINGER TRACT BASIN 4 ODA TO DRAIN DIRECTLY/INDIRECTLY TO REACH 2 OF CNL-1
- OTHER ODA TO DRAIN DIRECTLY TO CNL-1 OR ODCD-1
- EXISTING PUMP STATION WITH FLOW DIRECTION ARROW
- EXISTING CONTROL STRUCTURE WITH FLOW DIRECTION ARROW
- EXISTING C-41A CANAL PROJECT CULVERT

LOCAR PROPOSED WATER MANAGEMENT FEATURES

- ABOVE GROUND IMPOUNDMENT AGI-1 (ODA 9) PROPOSED LIMITS OF CONSTRUCTION
- FIXED WEIR OUTFALL/OVERFLOW CULVERT STRUCTURE WITH FLOW DIRECTION ARROW
- PERIMETER CANAL ADJUSTABLE WEIR STRUCTURE WITH FLOW DIRECTION ARROW
- UNGATED OVERFLOW SPILLWAY WITH FLOW DIRECTION ARROW
- UNGATED CULVERT WITH FLOW DIRECTION ARROWS
- GATED BI-DIRECTIONAL FLOW CONTROL STRUCTURE WITH FLOW DIRECTION ARROWS
- GATED OUTFLOW CULVERT STRUCTURE WITH FLOW DIRECTION ARROW
- ADJUSTABLE WEIR OUTFLOW CULVERT STRUCTURE WITH FLOW DIRECTION ARROW
- PUMP STATION WITH FLOW DIRECTION ARROW
- DRAINAGE/CANAL FLOW DIRECTION ARROW

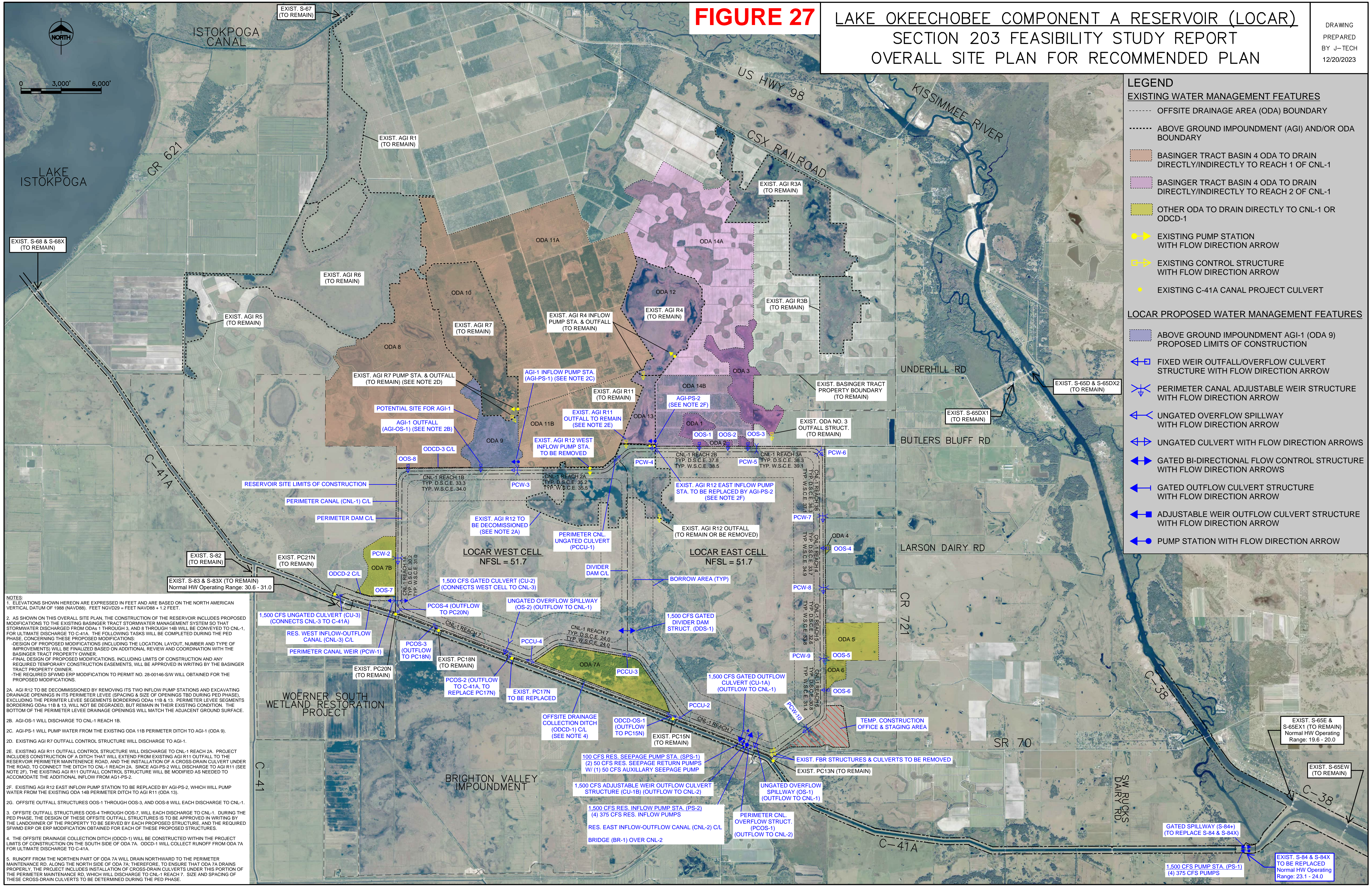
NOTES:

- ELEVATIONS SHOWN HEREON ARE EXPRESSED IN FEET AND ARE BASED ON THE NORTH AMERICAN VERTICAL DATUM OF 1988 (NAVD88). FEET NGVD29 = FEET NAVD88 + 1.2 FEET.
- AS SHOWN ON THIS OVERALL SITE PLAN, THE CONSTRUCTION OF THE RESERVOIR INCLUDES PROPOSED MODIFICATIONS TO THE EXISTING BASINGER TRACT STORMWATER MANAGEMENT SYSTEM SO THAT STORMWATER DISCHARGED FROM ODAs 1 THROUGH 3, AND 8 THROUGH 14B WILL BE CONVEYED TO CNL-1, FOR ULTIMATE DISCHARGE TO C-41A. THE FOLLOWING TASKS WILL BE COMPLETED DURING THE PED PHASE, CONCERNING THESE PROPOSED MODIFICATIONS:
 - DESIGN OF PROPOSED MODIFICATIONS (INCLUDING THE LOCATION, LAYOUT, NUMBER AND TYPE OF IMPROVEMENTS) WILL BE FINALIZED BASED ON ADDITIONAL REVIEW AND COORDINATION WITH THE BASINGER TRACT PROPERTY OWNER.
 - FINAL DESIGN OF PROPOSED MODIFICATIONS, INCLUDING LIMITS OF CONSTRUCTION AND ANY REQUIRED TEMPORARY CONSTRUCTION EASEMENTS, WILL BE APPROVED IN WRITING BY THE BASINGER TRACT PROPERTY OWNER.
 - THE REQUIRED SFVWD ERP MODIFICATION TO PERMIT NO. 28-00146-S/W WILL OBTAINED FOR THE PROPOSED MODIFICATIONS.
- AGI R12 TO BE DECOMMISSIONED BY REMOVING ITS TWO INFLOW PUMP STATIONS AND EXCAVATING DRAINAGE OPENINGS IN ITS PERIMETER LEVEE (SPACING & SIZE OF OPENINGS TBD DURING PED PHASE), EXCLUDING THE PERIMETER LEVEE SEGMENTS BORDERING ODAs 11B & 13. PERIMETER LEVEE SEGMENTS BORDERING ODAs 11B & 13, WILL NOT BE DEGRADED, BUT REMAIN IN THEIR EXISTING CONDITION. THE BOTTOM OF THE PERIMETER LEVEE DRAINAGE OPENINGS WILL MATCH THE ADJACENT GROUND SURFACE.
- AGI-OS-1 WILL DISCHARGE TO CNL-1 REACH 1B.
- AGI-PS-1 WILL PUMP WATER FROM THE EXISTING ODA 11B PERIMETER DITCH TO AGI-1 (ODA 9).
- EXISTING AGI R7 OUTFALL CONTROL STRUCTURE WILL DISCHARGE TO AGI-1.
- EXISTING AGI R11 OUTFALL CONTROL STRUCTURE WILL DISCHARGE TO CNL-1 REACH 2A. PROJECT INCLUDES CONSTRUCTION OF A DITCH THAT WILL EXTEND FROM EXISTING AGI R11 OUTFALL TO THE RESERVOIR PERIMETER MAINTENANCE ROAD, AND THE INSTALLATION OF A CROSS-DRAIN CULVERT UNDER THE ROAD, TO CONNECT THE DITCH TO CNL-1 REACH 2A. SINCE AGI-PS-2 WILL DISCHARGE TO AGI R11 (SEE NOTE 2F), THE EXISTING AGI R11 OUTFALL CONTROL STRUCTURE WILL BE MODIFIED AS NEEDED TO ACCOMMODATE THE ADDITIONAL INFLOW FROM AGI-PS-2.
- EXISTING AGI R12 EAST INFLOW PUMP STATION TO BE REPLACED BY AGI-PS-2, WHICH WILL PUMP WATER FROM THE EXISTING ODA 14B PERIMETER DITCH TO AGI R11 (ODA 13).
- OFFSITE OUTFALL STRUCTURES OOS-1 THROUGH OOS-3, AND OOS-8 WILL EACH DISCHARGE TO CNL-1.
- OFFSITE OUTFALL STRUCTURES OOS-4 THROUGH OOS-7, WILL EACH DISCHARGE TO CNL-1. DURING THE PED PHASE, THE DESIGN OF THESE OFFSITE OUTFALL STRUCTURES IS TO BE APPROVED IN WRITING BY THE LANDOWNER OF THE PROPERTY TO BE SERVED BY EACH PROPOSED STRUCTURE, AND THE REQUIRED SFVWD ERP OR ERP MODIFICATION OBTAINED FOR EACH OF THESE PROPOSED STRUCTURES.
- THE OFFSITE DRAINAGE COLLECTION DITCH (ODCD-1) WILL BE CONSTRUCTED WITHIN THE PROJECT LIMITS OF CONSTRUCTION ON THE SOUTH SIDE OF ODA 7A. ODCD-1 WILL COLLECT RUNOFF FROM ODA 7A FOR ULTIMATE DISCHARGE TO C-41A.
- RUNOFF FROM THE NORTHERN PART OF ODA 7A WILL DRAIN NORTHWARD TO THE PERIMETER MAINTENANCE RD. ALONG THE NORTH SIDE OF ODA 7A; THEREFORE, TO ENSURE THAT ODA 7A DRAINS PROPERLY, THE PROJECT INCLUDES INSTALLATION OF CROSS-DRAIN CULVERTS UNDER THIS PORTION OF THE PERIMETER MAINTENANCE RD, WHICH WILL DISCHARGE TO CNL-1 REACH 7. SIZE AND SPACING OF THESE CROSS-DRAIN CULVERTS TO BE DETERMINED DURING THE PED PHASE.

FIGURE 27

**LAKE OKEECHOBEE COMPONENT A RESERVOIR (LOCAR)
SECTION 203 FEASIBILITY STUDY REPORT
OVERALL SITE PLAN FOR RECOMMENDED PLAN**

DRAWING
PREPARED
BY J-TECH
12/20/2023



LEGEND

EXISTING WATER MANAGEMENT FEATURES

- OFFSITE DRAINAGE AREA (ODA) BOUNDARY
- ABOVE GROUND IMPOUNDMENT (AGI) AND/OR ODA BOUNDARY
- BASINGER TRACT BASIN 4 ODA TO DRAIN DIRECTLY/INDIRECTLY TO REACH 1 OF CNL-1
- BASINGER TRACT BASIN 4 ODA TO DRAIN DIRECTLY/INDIRECTLY TO REACH 2 OF CNL-1
- OTHER ODA TO DRAIN DIRECTLY TO CNL-1 OR ODCD-1
- ▶ EXISTING PUMP STATION WITH FLOW DIRECTION ARROW
- ▶ EXISTING CONTROL STRUCTURE WITH FLOW DIRECTION ARROW
- EXISTING C-41A CANAL PROJECT CULVERT

LOCAR PROPOSED WATER MANAGEMENT FEATURES

- ABOVE GROUND IMPOUNDMENT AGI-1 (ODA 9) PROPOSED LIMITS OF CONSTRUCTION
- ▶ FIXED WEIR OUTFALL/OVERFLOW CULVERT STRUCTURE WITH FLOW DIRECTION ARROW
- ▶ PERIMETER CANAL ADJUSTABLE WEIR STRUCTURE WITH FLOW DIRECTION ARROW
- ▶ UNGATED OVERFLOW SPILLWAY WITH FLOW DIRECTION ARROW
- ▶ UNGATED CULVERT WITH FLOW DIRECTION ARROWS
- ▶ GATED BI-DIRECTIONAL FLOW CONTROL STRUCTURE WITH FLOW DIRECTION ARROWS
- ▶ GATED OUTFLOW CULVERT STRUCTURE WITH FLOW DIRECTION ARROW
- ▶ ADJUSTABLE WEIR OUTFLOW CULVERT STRUCTURE WITH FLOW DIRECTION ARROW
- ▶ PUMP STATION WITH FLOW DIRECTION ARROW

NOTES:

- ELEVATIONS SHOWN HEREON ARE EXPRESSED IN FEET AND ARE BASED ON THE NORTH AMERICAN VERTICAL DATUM OF 1988 (NAVD88). FEET NGVD29 = FEET NAVD88 + 1.2 FEET.
- AS SHOWN ON THIS OVERALL SITE PLAN, THE CONSTRUCTION OF THE RESERVOIR INCLUDES PROPOSED MODIFICATIONS TO THE EXISTING BASINGER TRACT STORMWATER MANAGEMENT SYSTEM SO THAT STORMWATER DISCHARGED FROM ODAs 1 THROUGH 3, AND 8 THROUGH 14B WILL BE CONVEYED TO CNL-1, FOR ULTIMATE DISCHARGE TO C-41A. THE FOLLOWING TASKS WILL BE COMPLETED DURING THE PED PHASE, CONCERNING THESE PROPOSED MODIFICATIONS:
 - DESIGN OF PROPOSED MODIFICATIONS (INCLUDING THE LOCATION, LAYOUT, NUMBER AND TYPE OF IMPROVEMENTS) WILL BE FINALIZED BASED ON ADDITIONAL REVIEW AND COORDINATION WITH THE BASINGER TRACT PROPERTY OWNER.
 - FINAL DESIGN OF PROPOSED MODIFICATIONS, INCLUDING LIMITS OF CONSTRUCTION AND ANY REQUIRED TEMPORARY CONSTRUCTION EASEMENTS, WILL BE APPROVED IN WRITING BY THE BASINGER TRACT PROPERTY OWNER.
 - THE REQUIRED SFVMD ERP MODIFICATION TO PERMIT NO. 28-00146-S/W WILL OBTAINED FOR THE PROPOSED MODIFICATIONS.
- AGI R12 TO BE DECOMMISSIONED BY REMOVING ITS TWO INFLOW PUMP STATIONS AND EXCAVATING DRAINAGE OPENINGS IN ITS PERIMETER LEVEE (SPACING & SIZE OF OPENINGS TBD DURING PED PHASE), EXCLUDING THE PERIMETER LEVEE SEGMENTS BORDERING ODAs 11B & 13. PERIMETER LEVEE SEGMENTS BORDERING ODAs 11B & 13, WILL NOT BE DEGRADED, BUT REMAIN IN THEIR EXISTING CONDITION. THE BOTTOM OF THE PERIMETER LEVEE DRAINAGE OPENINGS WILL MATCH THE ADJACENT GROUND SURFACE.
- AGI-OS-1 WILL DISCHARGE TO CNL-1 REACH 1B.
- AGI-PS-1 WILL PUMP WATER FROM THE EXISTING ODA 11B PERIMETER DITCH TO AGI-1 (ODA 9).
- EXISTING AGI R7 OUTFALL CONTROL STRUCTURE WILL DISCHARGE TO AGI-1.
- EXISTING AGI R11 OUTFALL CONTROL STRUCTURE WILL DISCHARGE TO CNL-1 REACH 2A. PROJECT INCLUDES CONSTRUCTION OF A DITCH THAT WILL EXTEND FROM EXISTING AGI R11 OUTFALL TO THE RESERVOIR PERIMETER MAINTENANCE ROAD, AND THE INSTALLATION OF A CROSS-DRAIN CULVERT UNDER THE ROAD, TO CONNECT THE DITCH TO CNL-1 REACH 2A. SINCE AGI-PS-2 WILL DISCHARGE TO AGI R11 (SEE NOTE 2F), THE EXISTING AGI R11 OUTFALL CONTROL STRUCTURE WILL BE MODIFIED AS NEEDED TO ACCOMMODATE THE ADDITIONAL INFLOW FROM AGI-PS-2.
- EXISTING AGI R12 EAST INFLOW PUMP STATION TO BE REPLACED BY AGI-PS-2, WHICH WILL PUMP WATER FROM THE EXISTING ODA 14B PERIMETER DITCH TO AGI R11 (ODA 13).
- OFFSITE OUTFALL STRUCTURES OOS-1 THROUGH OOS-3, AND OOS-8 WILL EACH DISCHARGE TO CNL-1.
- OFFSITE OUTFALL STRUCTURES OOS-4 THROUGH OOS-7, WILL EACH DISCHARGE TO CNL-1. DURING THE PED PHASE, THE DESIGN OF THESE OFFSITE OUTFALL STRUCTURES IS TO BE APPROVED IN WRITING BY THE LANDOWNER OF THE PROPERTY TO BE SERVED BY EACH PROPOSED STRUCTURE, AND THE REQUIRED SFVMD ERP OR ERP MODIFICATION OBTAINED FOR EACH OF THESE PROPOSED STRUCTURES.
- THE OFFSITE DRAINAGE COLLECTION DITCH (ODCD-1) WILL BE CONSTRUCTED WITHIN THE PROJECT LIMITS OF CONSTRUCTION ON THE SOUTH SIDE OF ODA 7A. ODCD-1 WILL COLLECT RUNOFF FROM ODA 7A FOR ULTIMATE DISCHARGE TO C-41A.
- RUNOFF FROM THE NORTHERN PART OF ODA 7A WILL DRAIN NORTHWARD TO THE PERIMETER MAINTENANCE RD. ALONG THE NORTH SIDE OF ODA 7A; THEREFORE, TO ENSURE THAT ODA 7A DRAINS PROPERLY, THE PROJECT INCLUDES INSTALLATION OF CROSS-DRAIN CULVERTS UNDER THIS PORTION OF THE PERIMETER MAINTENANCE RD, WHICH WILL DISCHARGE TO CNL-1 REACH 7. SIZE AND SPACING OF THESE CROSS-DRAIN CULVERTS TO BE DETERMINED DURING THE PED PHASE.

12/20/2023 10:00 AM J-TECH

Prepared for:	South Florida Water Management District
Prepared by:	J-Tech, an Alliance between Jacobs Engineering and Tetra Tech, Inc.
Date:	January 17, 2024
Subject:	Lake Okeechobee Component A Storage Reservoir Feasibility Study – Dam Breach Analysis

1.0 Introduction

This memorandum summarizes J-Tech’s development of a two-dimensional (2D) hydrodynamic dam breach model of the Lake Okeechobee Component A Storage Reservoir (LOCAR) Recommended Plan (presented in the LOCAR Section 203 Feasibility Study Report, dated October 2023), referred to in this memorandum as Alternative 1 (Alt1). The 2D model was developed using Hydrologic Engineering Center’s River Analysis System (HEC-RAS) v6.3.1 (U.S. Army Corps of Engineers [USACE] 2023). The objectives of the analysis presented in this memorandum are:

- Determine the characteristics associated with failure of the LOCAR Alt1 embankment for three dam breach conditions: Probable Maximum Precipitation (PMP); 100-year, 72-hour storm frequency event; and Sunny Day.
- Determine the extents and characteristics of the flood wave from a LOCAR Alt1 embankment breach in four locations.
- Determine differences in inundation depths caused by failure of LOCAR Alt1 embankment during a PMP event and 100-year, 72-hour storm frequency event.
- Provide inundation maps of dam breach scenarios showing fastest arrival times, maximum flood depths, and maximum velocities.

Four dam breach locations for LOCAR Alt1 were identified by J-Tech and reviewed by the South Florida Water Management District (SFWMD). The breach locations were primarily focused on the biggest impacts on transportation, residential, and agricultural lands near the reservoir. The four locations evaluated for LOCAR Alt1 dam breach analysis include (Figure 1):

1. Location 1: From LOCAR towards the Kissimmee River to the residential properties and County Road 721
2. Location 2: From LOCAR towards C-41A, residential properties, and State Road 70
3. Location 3: From LOCAR away from C-41A towards State Road 70 and C-40
4. Location 4: From LOCAR away from C-41A towards the Brighton Valley Impoundment

The 1,500 cubic feet per second (cfs) gated divider dam culvert between the east and west cells in the reservoir was not considered in dam breach analysis. The entire reservoir storage from both cells was used for the analysis to represent the worst-case conditions in the event of a dam breach.

Lake Okeechobee Component A Storage Reservoir Dam Breach Analysis

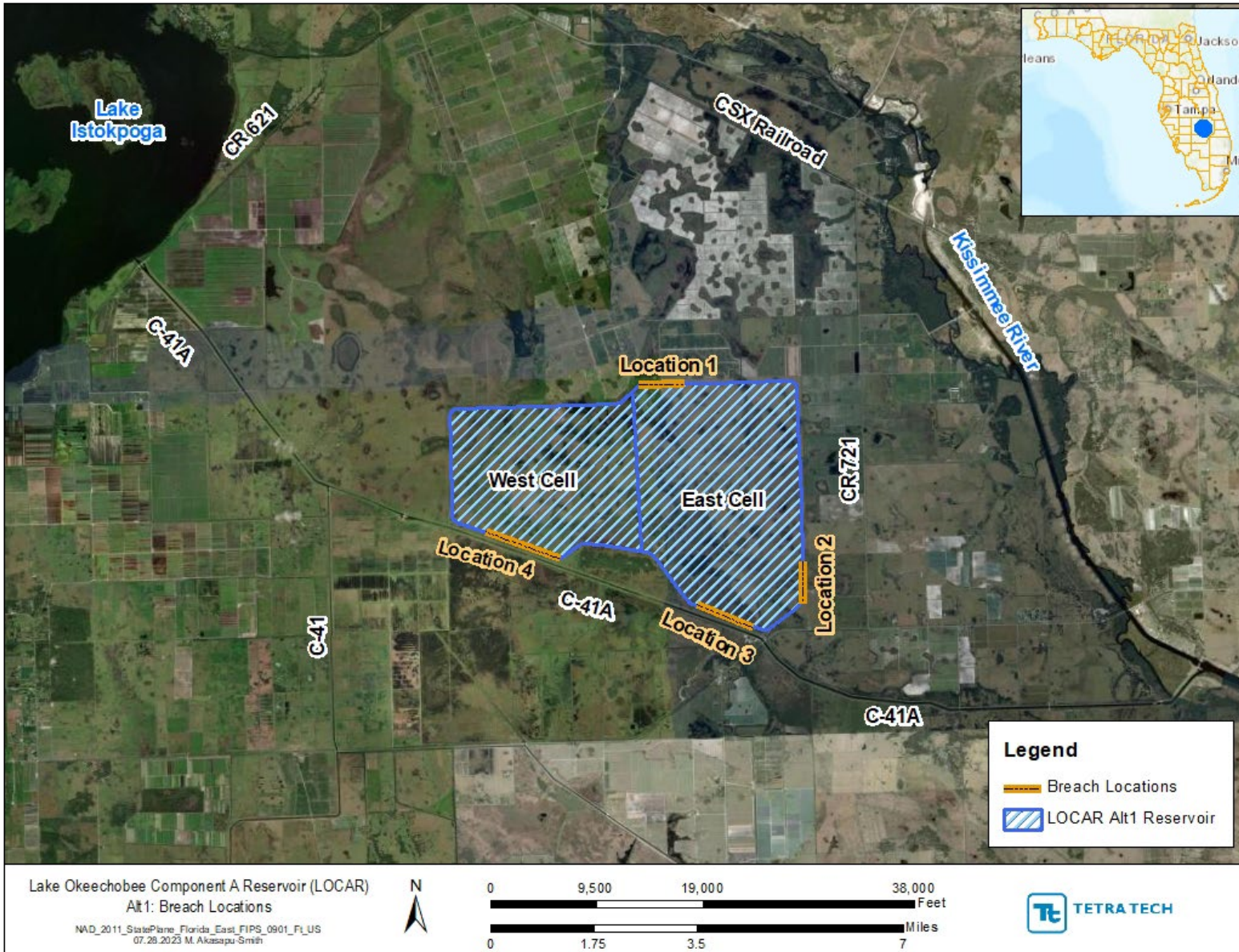


Figure 1. Dam Breach Locations for LOCAR Alt1

2.0 Project Area Description

LOCAR Alt1 will be located approximately 10 miles south of Lake Istokpoga, and approximately 18 miles north of Lake Okeechobee as shown in Figure 2. LOCAR Alt1 is proposed to have a normal pool storage (elevation) level (NFSL) of 51.7 feet North American Vertical Datum of 1988 (NAVD88) and a storage of approximately 200,811 acre-feet at NFSL (115,583 acre-feet of storage in the east cell and 85,228 acre-feet in the west cell).

There will be a 1,500 cfs gated divider dam culvert between the east and west cells with two ungated overflow spillways to C-41A. Additionally, a 1,500 cfs inflow pump station and a gated outflow culvert between the east cell and C-41A and a 1,500 cfs ungated outflow culvert and canal from the west cell to C-41A are proposed. Average ground surface elevation along the perimeter dam centerline would be 32.9 feet NAVD88 with an average water depth at NFSL along the perimeter dam of 18.8 feet. The exterior top of berm (TOB) elevation is proposed at 66.36 feet NAVD88 sloping 2% towards the interior at an TOB elevation of 66.00 feet NAVD88. The berm was set at 3H:1V slope on the exterior end of TOB set at 70.46 feet NAVD88. The overall site plan of LOCAR Alt1 and the typical section of the east and west cells can be seen in Figure 2 and Figure 3.

The reservoir will be bounded by the CSX Railroad and US Highway 98 on the north, on the south by C-41A and Brighton Valley Impoundment, on the east by the Kissimmee River, and on the west by County Road 621 and Lake Istokpoga. A major portion of this area is pastureland, which is crossed by a series of irrigation ditches and canals, discharging into the larger C-41A. Lake Istokpoga and Lake Okeechobee are connected via C-41A. The Brighton Valley Impoundment area is surrounded by C-41A to its north, C-41 to its west, and C-39A to its south and east. Brighton Valley Impoundment is part of the dispersed water management project developed to store and treat excess stormwater runoff before it reaches Lake Okeechobee (SFWMD 2022). To the southeast of the Brighton Valley Impoundment is the Brighton Seminole Indian Reservation located in Glades County.

Lake Okeechobee Component A Storage Reservoir Dam Breach Analysis

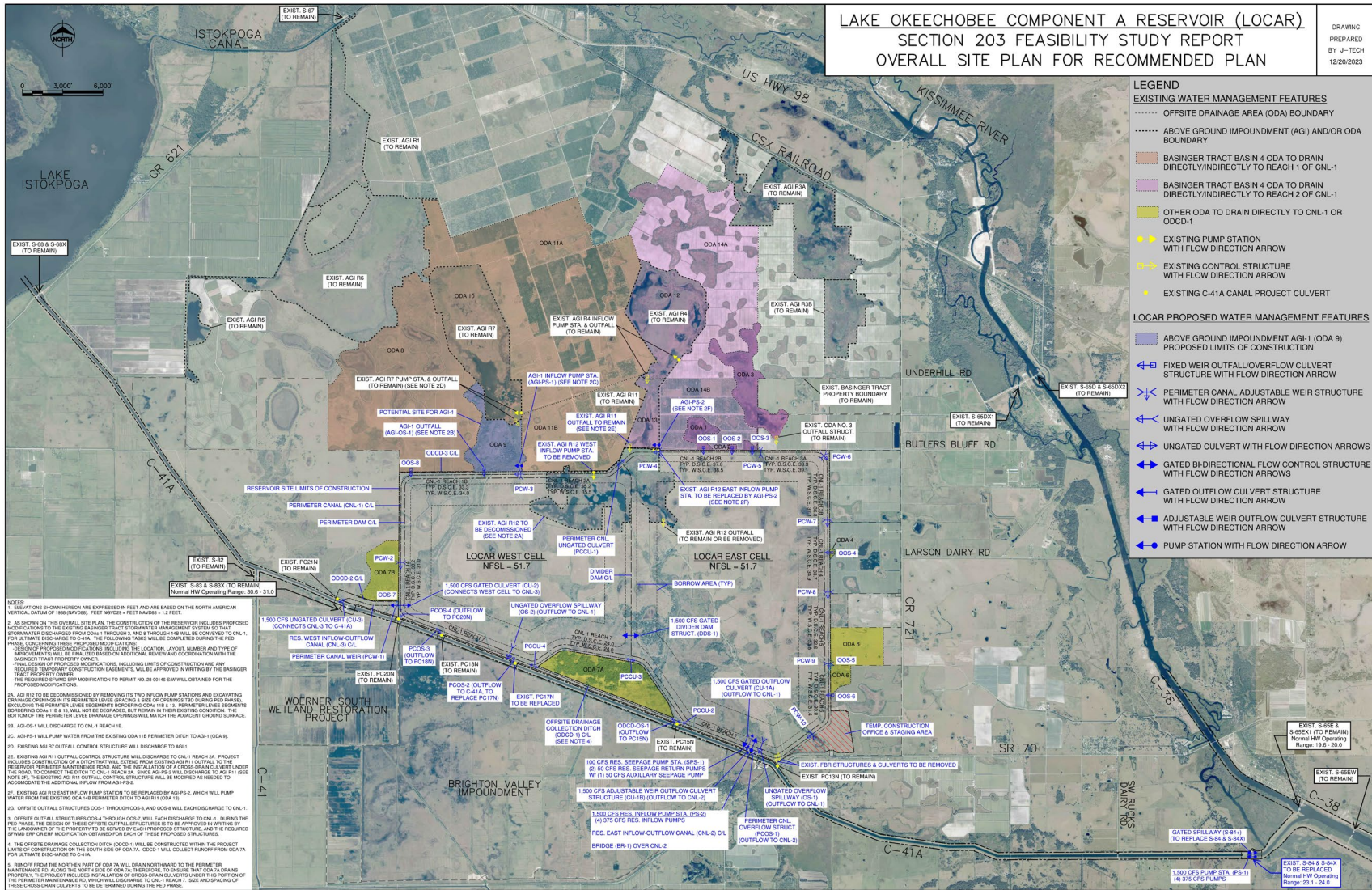


Figure 2. Overall Site Plan of LOCAR Alt1

Lake Okeechobee Component A Storage Reservoir Dam Breach Analysis

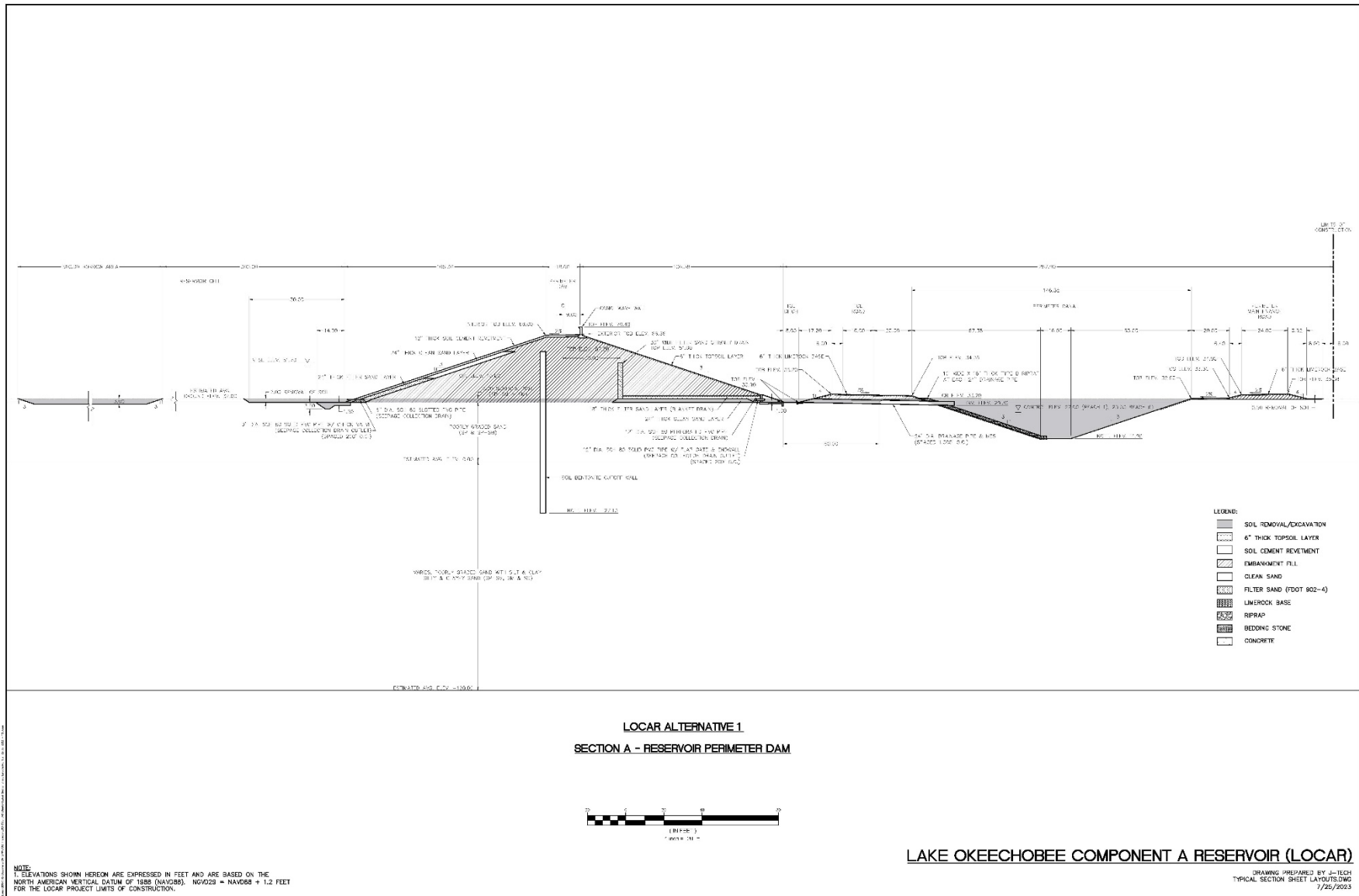


Figure 3. Typical Section of East and West Cells

3.0 Hydrology

Three dam breach conditions (PMP; 100-year, 72-hour; and Sunny Day), and two non-breach conditions (PMP and 100-year, 72-hour) were evaluated.

PMP depth and its routing were simulated in Hydrologic Engineering Center's Meteorological Visualization Utility Engine (HEC-MetVue), for the proposed LOCAR Alt1. The PMP total at the center of the reservoir was estimated at 54.74 inches (4.6 feet) based on the LOCAR PMP-PMF model. For the PMP breach and non-breach condition, the total 72-hour PMP depth of 4.6 feet was added to the normal pool elevation, for a PMP reservoir elevation of 56.3 feet NAVD88. As LOCAR Alt1 has a proposed storage of approximately 200,811 acre-feet at normal pool elevation, the additional volume from the PMP event is 51,690 acre-feet above the NFSL. The 72-hour, 15-minute PMP incremental rainfall depth was applied to the entire model domain as a gridded dataset to characterize the incremental risk (Figure 4). The inset in Figure 4 shows the peak PMP distribution. For the PMP breach conditions, the reservoir was set to breach at 56.3 feet NAVD88. However, when the model was run at this elevation, a breach was not triggered. Therefore, the model was rerun to force a breach after 47 hours and 50 minutes, when the peak PMP depth was achieved.

Based on National Oceanic and Atmospheric Administration (NOAA) Atlas 14, Volume 9, Version 2, at the centroid of the model domain, the 100-year, 72-hour point precipitation depth is 10.9 inches, with 8.33 inches and 14.5 inches estimated at lower and upper bounds of the 90% confidence intervals. SFWMD standard rainfall distribution for 72-hour rainfall event was applied to the NOAA Atlas 14 precipitation depth and divided by 135.9% to ensure the cumulative percentage of 72-hour rainfall adds up to 100% because the 72-hour rainfall distribution is based on a 24-hour rainfall event (Figure 5). The 100-year, 72-hour rainfall distribution was applied to the entire model domain. The 100-year, 72-hour rainfall depth of 0.91 feet (10.9 inches) was added to the normal pool elevation, for a 100-year reservoir elevation of 52.61 feet NAVD88, with an additional volume of 10,212 acre-feet above the NFSL. For the 100-year, 72-hour breach conditions, the reservoir was set to breach at 52.61 feet NAVD88.

For the Sunny Day event, no additional rainfall was applied on the surface and the normal pool elevation of reservoir was set to 51.7 feet NAVD88, which was the breach elevation for the reservoir.

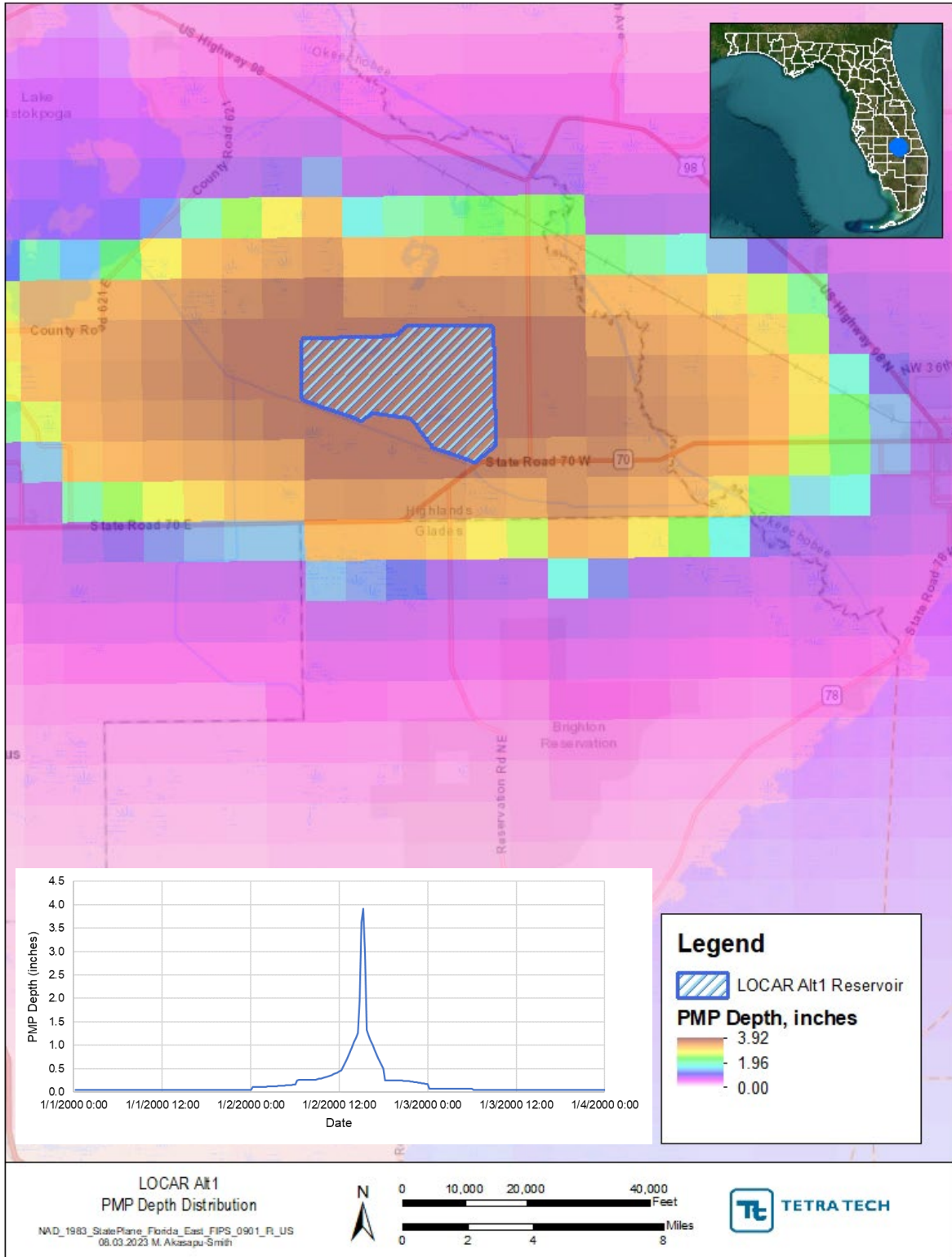


Figure 4. Peak PMP Distribution (January 2, 2000, 20:45) Applied to LOCAR Alt1 Dam Breach Model

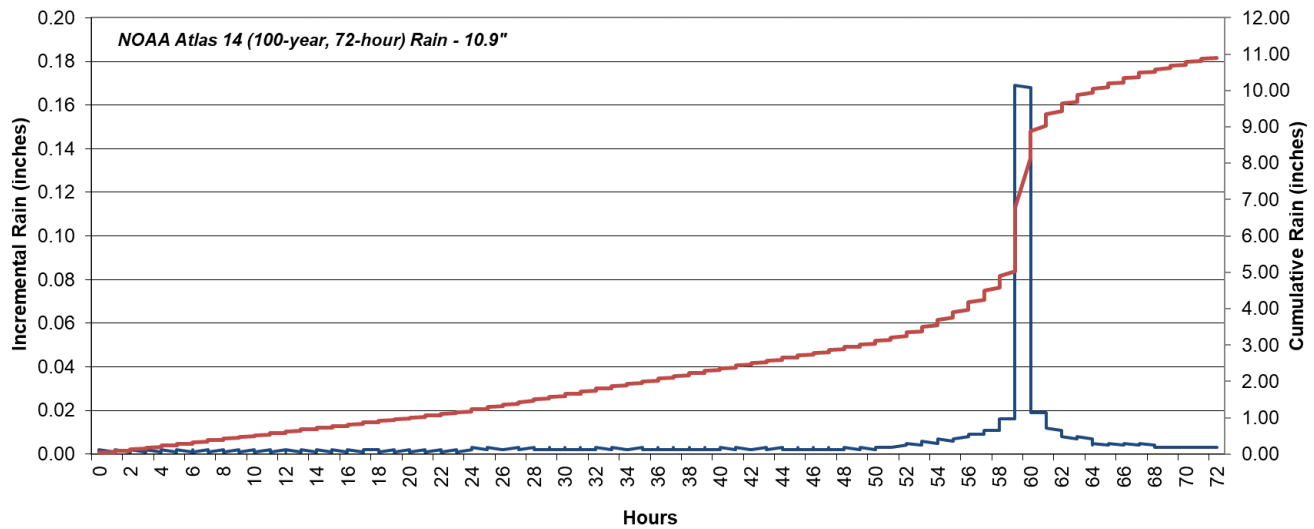


Figure 5. NOAA Atlas 14 Precipitation Distribution Applied to LOCAR Alt1 Dam Breach Model

4.0 Hydraulic Model Development

To characterize and identify threats to life and property in the event of dam failure, an unsteady 2D flow model was setup in USACE’s HEC-RAS Version 6.3.1 to simulate a dam breach. The following sections detail the methodologies used to model the unsteady flow in HEC-RAS.

4.1 Model Domain

The 536-square mile model domain extends from south of Lake Istokpoga along County Road 621 East south towards Palmdale and connecting to the Herbert Hoover Dike (HHD) (Figure 6). The model domain includes the Kissimmee River extending approximately 0.7 miles from the river north to connect County Road 621 East. LOCAR Alt1 is at the center of the model domain with C-41A located immediately south.

The model domain was divided into two 2D flow areas since LOCAR Alt1 is in the middle of the model domain. To overcome the limitation within HEC-RAS to draw a model domain around a reservoir, the two 2D flow areas were connected via weir connections for the breach flood wave to move between the two areas seamlessly. Weir width was set to 1 foot and a weir coefficient of 0.3 was used for this non-elevated overbank terrain connection. The connection was made at the northwest end of the reservoir system as seen in Figure 6.

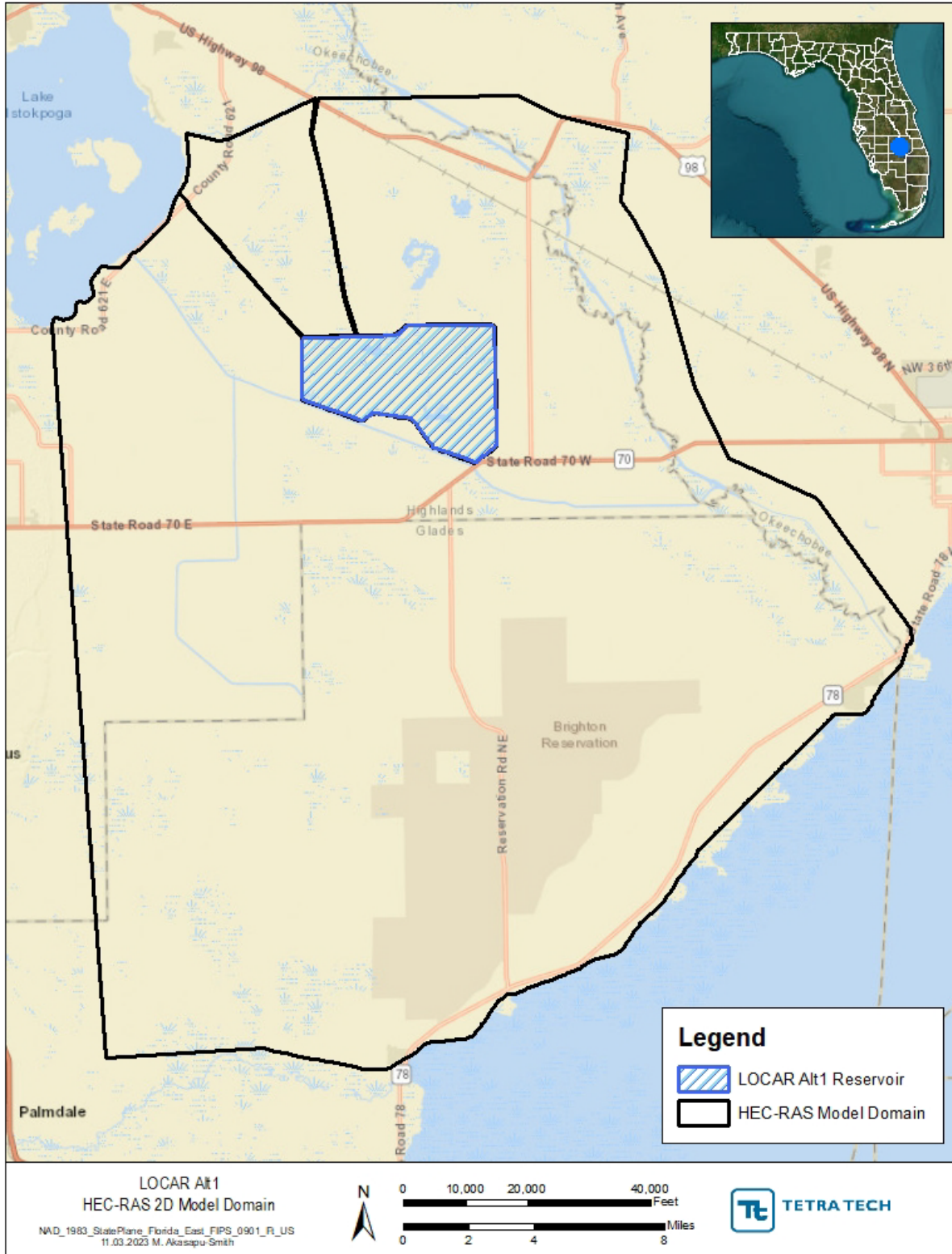


Figure 6. Domain for LOCAR Alt1 Dam Breach Model

4.2 Model Topography

The model topography serves as the basis for the hydraulic computations and is comprised of:

- Light Detection and Ranging (LiDAR) data derived Digital Elevation Model (DEM);
- National Elevation Dataset (NED) rasters;
- Design for the C-41A, C-41, C-40, C-39A, and C-38; details on the gated spillways located on C-41A, C-41, C-40, and C-38;
- Reservoir embankment;
- Two ungated overflow spillways; and
- Perimeter canal around the reservoir.

U.S. Geological Survey's (USGS) 2018 Highlands County LiDAR DEM coverage, available at a 1-meter (3.28 feet) horizontal resolution, was used for the dam breach model domain. However, the Brighton Seminole Indian Reservation area was not part of the study. Therefore, the LiDAR DEM coverage was merged with 1/3 arc-second horizontal resolution (32.8 feet) NED raster. The two DEM raster datasets were merged in HEC-RAS Ras Mapper and resampled to a 3-foot horizontal resolution. The merged DEM raster was edited to incorporate features as discussed in the following section.

4.2.1 Features

The surface topography was edited to include the reservoir embankments for LOCAR Alt1 as seen in Figure 3. In addition, the perimeter canal, CNL-1, and two ungated overflow spillways, OS-1, and OS-2, were included. A preliminary design CAD drawing, dated July 20, 2023, showing the key geometric features was used to modify the topographic surface. A TOB elevation on the exterior end of the embankment was set to 66.36 feet NAVD88, sloping 2% towards the interior end of the reservoir, which was set to 66.0 feet NAVD88. The crest width of the perimeter dam was set at 18 feet, and the embankment slopes were 3H:1V. The divider dam between the east and west cells was not included to be conservative. The bottom width of the perimeter canal was 16 feet and sloped up at 3H:1V. The ungated overflow spillways, OS-1 and OS-2, were set at a width of 25 feet with the control elevation at 51.7 feet NAVD88 and the stepped chute along the perimeter dam coming down at 3H:1V until it reached the bare earth surface. The surface raster from CAD was added to the merged DEM raster (Figure 7).

The merged DEM raster was modified to represent the C-41A, C-41, C-40, C-39A, and C-38 bathymetry to better capture the conveyance capacity of the canal system. These modifications were performed in HEC-RAS Ras Mapper based on the information provided in the as-builts of the canals (Figure 7).

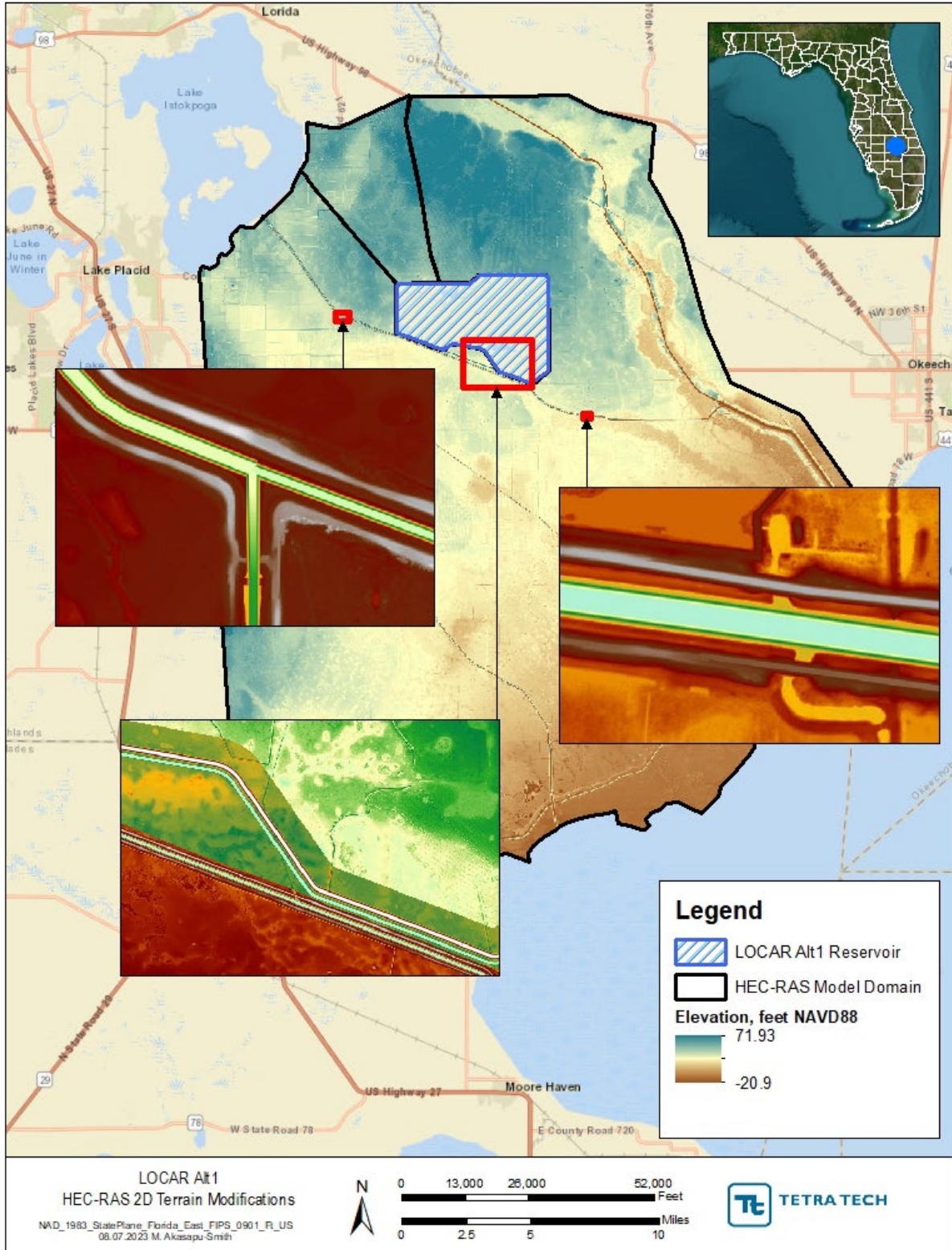


Figure 7. Terrain Modifications Performed to Represent Features for LOCAR Alt1 Dam Breach Model

4.3 Model Components

4.3.1 Model Mesh

HEC-RAS allows for automatically generating a computational mesh by defining the project domain and specifying a desired resolution. In each model, the domain was defined as shown in Figure 6, using a base resolution of 300 feet. To improve the automatically generated mesh, breaklines were added at key features such as within the canals (C-41A, C-41, C-40, C-39A, and C-38), levees (L-48, L-49, L-59, L-60, L-61), HDD (Inset 1 and 2 in Figure 8), along road embankments (US Highway 98, County Road 721, State Road 70, and State Road 78), and along Kissimmee River (Inset 3 in Figure 8). Adding breaklines helped capture the needed hydraulic details in the model because the infrastructure would serve as weirs to block flow when the dam breaches. Breaklines were also used to increase the mesh resolution and better capture the topographic details. The mesh resolution was increased to 50 to 75 feet along the canals and levees, and up to 100 feet near road embankments and along the Kissimmee River (Figure 8).

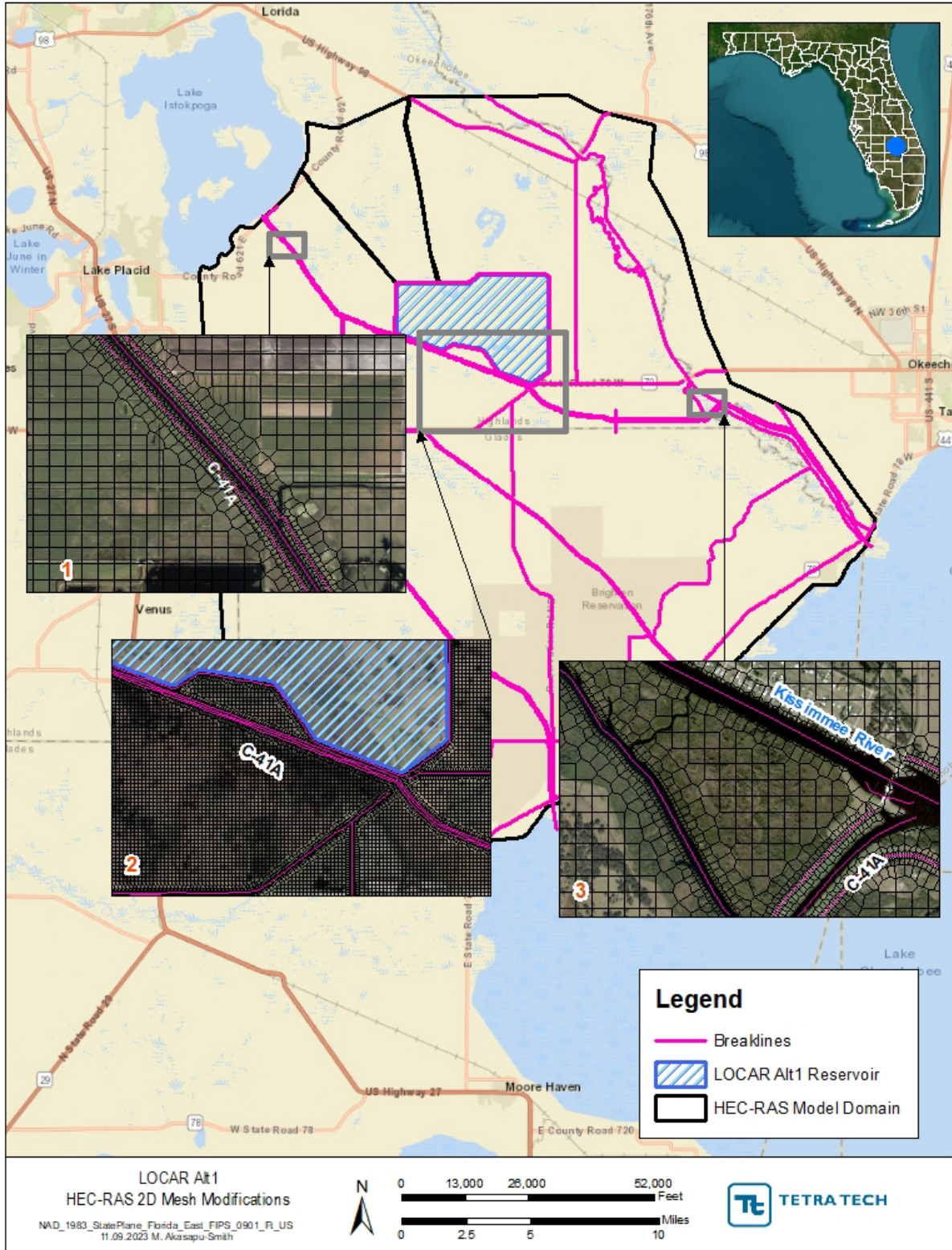


Figure 8. Closer View of the HEC-RAS 2D Flow Area for LOCAR Alt1 Dam Breach Model

4.3.2 Elevation-Storage Rating Curves

LOCAR Alt1 was modeled as a storage area, with the embankments modeled using the storage area connection option within HEC-RAS, which allows for defining the embankment geometry and adding breaches. Each reservoir cell (east and west cells) was modeled as one storage area in HEC-RAS. The primary relationship used to define a storage area within HEC-RAS is the elevation-storage curve, which defines the available volume within each reservoir cell and specified elevations. The stage-storage rating curve for the east and west cells were developed by J-Tech. For the purposes of the dam breach analysis, the stage-storage rating curves from each cell were combined as seen in Figure 9. The LOCAR Alt1 elevation-storage relationship defined the storage volume at the NFSL (200,811 acre-feet) and the top of the embankment (366,170 acre-feet).

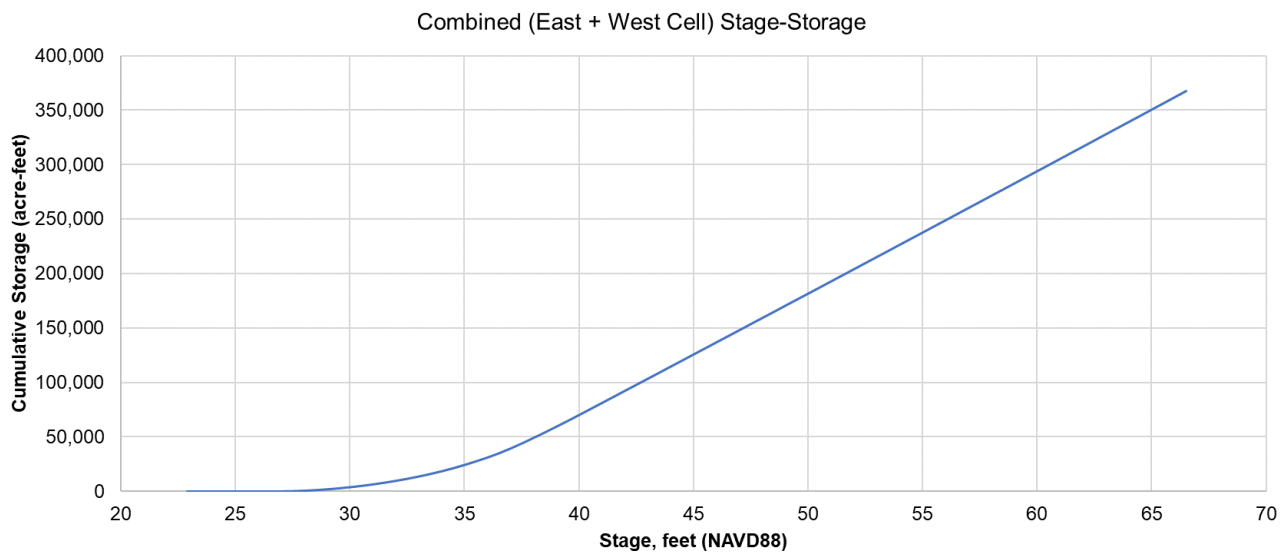


Figure 9. Stage-Storage Rating Curve Used to Define LOCAR Alt1

4.3.3 Bridges

Inline structures along State Road 70 East and West crossing at C-41A and Kissimmee River were included in the dam breach model. The bridges were represented based on the information in plans of proposed State Highway, State Job No. 09060-3503-01-31, State Road No. 70, Highlands County. The two bridges were modeled as Storage Area/2D Flow Area connections as bridge structure type in the HEC-RAS 2D model. The deck elevation of the bridge crossing at C-41A was set to 32.47 feet NAVD88, and 40.8 feet NAVD88 along Kissimmee River.

4.3.4 Water Control Structures

Sixteen water control structures were included in the model domain. Structure book pages were used to obtain information on the structure’s discharge characteristics, hydraulic description, and Maximum Allowable Gate Opening curves. Gate properties used for the structures in the model are in Table 1. Operation rules assigned to these structures are in Table 2. The gate opening and closing rate was assumed to be 1 foot/min for all the gated spillways. Q_{DESIGN} was used for the Sunny Day dam breach model, and Q_{SPF} was used for the PMP and 100-year, 72-hour storm events for breach and non-breach events. Q_{DESIGN} and Q_{SPF} discharge rates were provided by SFWMD on September 15, 2023, and were used in setting up the operation rules for the gated spillways.

Table 1. Gate Properties for the Water Control Structures Represented in LOCAR Alt1 Model Domain

Structure	Location	Number of Gates	Height of the Gate, feet	Width of the Gate, feet	Invert Elevation of the Gate, feet NAVD88
S-68	C-41A	3	10.2	21.8	30.0
S-68X	C-41A	1	12.0	11.0	27.8
S-83	C-41A	1	13.6	25.8	17.2
S-83X	C-41A	1	10.0	11.0	20.8
S-84	C-41A	2	11.8	21.0	11.9
S-84X	C-41A	1	10.0	11.0	12.3
S-65D	C-38	4	13.8	27.8	11.9
S-65DX1	C-38	4	5.0	5.0	27.7
S-65DX2	C-38	2	14.4	27.0	17.7
S-65E	C-38	6	13.8	27.8	8.4
S-65EX1	C-38	3	14.0	27.0	8.4
S-70	C-41	2	12.0	27.8	13.7
S-71	C-41 (Harney Pond)	3	11.2	25.8	8.9
S-82	C-41	2	7.2	23.7	25.5
S-72	C-40 (Prairie)	2	12.0	27.8	8.6
S-75	C-40 (Prairie)	1	10.0	28.8	15.8

Table 2. Operation Rules of Water Control Structures Represented in LOCAR Alt1 Model Domain

Structure	Location	Maximum Opening Height	Minimum Opening Height	Q _{DESIGN} , cfs	Q _{SPF} , cfs
S-68	C-41A	2	1	5,900	5,900
S-68X	C-41A	7	5	1,000	1,000
S-83	C-41A	7	4	3,830	3,830
S-83X	C-41A	6	2	1,000	1,000
S-84	C-41A	7	3.5	5,670	9,000
S-84X	C-41A	4	1	1,000	1,000
S-65D	C-38	8	5	21,300	21,300
S-65DX1	C-38	5	1	1,000	1,000
S-65DX2	C-38	5	3	8,600	9,700

Structure	Location	Maximum Opening Height	Minimum Opening Height	Q _{DESIGN} , cfs	Q _{SPF} , cfs
S-65E	C-38	8	5	24,000	24,000
S-65EX1	C-38	7.5	3.5	12,000	13,000
S-70	C-41	7	2.5	4,470	4,470
S-71	C-41 (Harney Pond)	7	2	6,000	6,000
S-82	C-41	4	0.5	2,100	2,100
S-72	C-40 (Prairie)	7	2	3,120	3,120
S-75	C-40 (Prairie)	6	2	1,150	2,100

4.4 Surface Roughness

To estimate the distributed Manning’s n values used in the model, the USACE Modeling Mapping and Consequence (MMC) Production Center recommends using the National Land Cover Database (NLCD) land use classes (USACE 2018). The 2019 NLCD land use mapping is shown in Figure 10. The MMC also provides general guidance for the assignment of Manning’s n values, which are summarized in Table 3. The land use most prevalent within the modeling domain is pasture/hay (Figure 10).

Table 3. Recommended Manning’s n Values for Associated Land Cover Data

NLCD Code	Land Use Description	Manning’s n
11	Open water	0.030
21	Developed, open space	0.035
22	Developed, Low Intensity	0.050
23	Developed, Medium Intensity	0.055
24	Developed, High Intensity	0.065
31	Barren Land (Rock – Sand-Clay)	0.030
41	Deciduous Forest	0.180
42	Evergreen Forest	0.160
43	Mixed Forest	0.190
52	Shrub/Scrub	0.100
71	Grassland/Herbaceous	0.070
81	Pasture/Hay	0.060
82	Cultivated Crops	0.055
90	Woody Wetlands	0.080
95	Emergent Herbaceous Wetlands	0.070

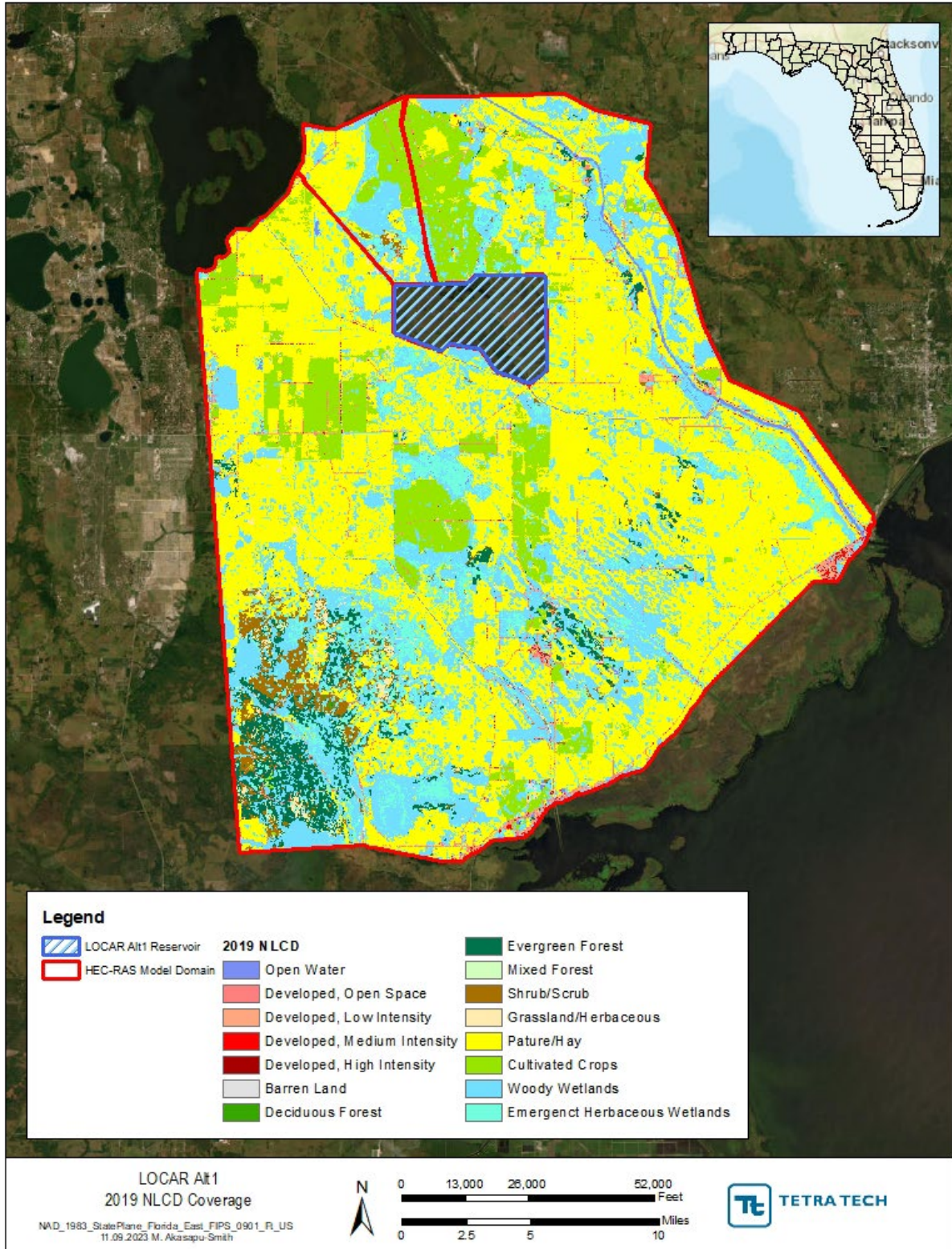


Figure 10. Land Use Used in LOCAR Alt1 Dam Breach Model

4.5 Boundary Conditions

The canals provide the primary method for conveying flows out of the modeling domain. To ensure a reasonable condition for C-41A, the Lake Istokpoga regulation schedule was used as provided in the S-68/S-68X structure book page. The Lake Istokpoga Regulation Schedule shows that the Zone A regulatory release made through S-68/S-68X is set to a firm capacity of 3,000 cfs and a secondary capacity up to 6,900 cfs. Therefore, for the PMP and 100-year, 72-hour breach and non-breach conditions, the Zone A regulatory release of 3,000 cfs was used as an inflow boundary condition from Lake Istokpoga into C-41A. For the Sunny Day dam breach condition, an assumed release of 100 cfs was applied to maintain water in the canals. An inflow boundary condition was also applied at C-38/Kissimmee River, and a constant flow of 250 cfs was applied for the Sunny Day dam breach condition, and a constant flow of 3,000 cfs for the PMP and 100-year, 72-hour breach and non-breach conditions.

On the perimeter of the model domain along HHD, stage hydrograph boundary conditions were assigned at the three canal outlets: C-41, C-40, and C-38. A constant stage of 15.79 NAVD88 (17.0 feet NGVD29) was assigned for the Sunny Day dam breach condition, and 17.99 feet NAVD88 (19.2 feet NGVD29) for the PMP and 100-year, 72-hour breach and non-breach conditions. The stages applied at canal outlets were verified by SFWMD. Setting the stage hydrograph at the three canal outlets caused backflow moving up the canals through the gated spillways; therefore, to avoid backflow, operation rules were set to block the water moving upstream of the gated spillways at S-71 (C-41 [Harney Pond]), S-72 (C-40 [Prairie]), S-65E (C-38), and S-84 (C-41A).

The starting reservoir elevation was assigned in LOCAR Alt1 as 51.7 feet NAVD88. All three dam breach models used HEC-RAS's original Shallow Water Equations, Eulerian-Lagrangian Method (SWE-ELM) to solve for flow moving over the computational mesh. Each simulation was run for a duration of five days to capture the receding end of the breach hydrograph at the outlet of the model domain by Lake Okeechobee. The Sunny Day dam breach model used a computational interval of one second. For the 100-year, 72-hour breach and non-breach conditions, the computational interval was based on the time series of divisors, where a computational interval of five seconds was used from day 1 through 20 hours into day 3, 0.5 seconds from 20 hours into day 3 through day 4, and 0.75 seconds for day 5. A computational interval of five seconds was used from day 1 through 20 hours into day 3, and 0.5 seconds from 20 hours into day 3 until the end of the simulation. The time series of divisors approach was used for the PMP and 100-year, 72-hour breach and non-breach conditions to avoid any oscillations along the breach hydrograph at the four breach locations.

4.6 Breach Parameters

The breach parameters, such as widths, formation times, and side slopes, were based on the Froehlich equations (Froehlich 2008). These equations were derived using data from 74 earthen fill dams and are valid for dam heights from 10 to 305 feet and impoundment volumes between 11 and 535,000 acre-feet. The Froehlich equations for average breach width and failure time are:

$$b_w = 0.27k_o V_w^{0.32} H_b^{0.04}$$
$$t_f = 63.2 \sqrt{\frac{V_w}{gH_b^2}}$$

where: b_w is the average width of final trapezoidal breach, feet

k_o is the overtopping coefficient used to calculate average breach width (1.3 for overtopping)

V_w is the reservoir volume at the time of breach cubic feet

H_b is the maximum height of the final trapezoidal breach, feet

t_f is the breach formation time, seconds

g is the acceleration due to gravity, 32.2 feet/sec²

The Parameter Calculator tool within HEC-RAS was used to calculate the breach parameters and the Froehlich (2008) method was used. The top of the dam elevation for LOCAR Alt1 was set at 66.36 feet NAVD88, nearly 10.2 feet above the PMP elevation of 56.3 feet NAVD88; therefore, only piping failure was considered regardless of the breach location. The breach parameters for each modeled breach is summarized in Table 4.

Table 4. Summary of Breach Parameters Used in LOCAR Alt1 Dam Breach Models

Breach Type	Reservoir Elevation at Failure (feet, NAVD88)	Breach Bottom Elevation (feet, NAVD88)	Reservoir Volume at Time of Breach (acre-feet)	Breach Bottom Width (feet)	Breach Side Slopes	Breach Formation Time (hours)
PMP Piping	56.20	35.866 (Loc#1) 33.75 (Loc#2) 27.761 (Loc#3) 27.761 (Loc#4)	252,501	484 (Loc#1) 484 (Loc#2) 484 (Loc#3) 484 (Loc#4)	0.7	10.64 (Loc#1) 9.95 (Loc#2) 8.41 (Loc#3) 8.41 (Loc#4)
100-year, 72-hour, Piping	52.61	Same as PMP	211,023	456 (Loc#1) 456 (Loc#2) 455 (Loc#3) 455 (Loc#4)	0.7	9.73 (Loc#1) 9.10 (Loc#2) 7.69 (Loc#3) 7.69 (Loc#4)
Sunny Day Piping	51.70	Same as PMP	200,811	449 (Loc#1) 448 (Loc#2) 447 (Loc#3) 447 (Loc#4)	0.7	9.49 (Loc#1) 8.88 (Loc#2) 7.5 (Loc#3) 7.5 (Loc#4)

5.0 Results

After setting up the model as described in Section 4.0, each breach scenario was run and checked for convergence errors (errors caused if features in terrain are not appropriately represented in the model mesh) in water surface elevations (WSEs) and volume accounting errors (percent difference between starting and ending

volumes in the 2D flow area). The errors in WSE and volume were within the set tolerance limits for the models. In addition, the stage and flow hydrograph at each breach locations for all the breach scenarios were checked and corrected for oscillations in the breach hydrograph causing negative flows.

Inundation maps showing maximum depths, maximum velocities, and maximum arrival travel times from the Sunny Day dam breach conditions are included in Appendix A for breach locations 1 through 4 (Figure A-1 through Figure A-12). In HEC-RAS, maximum arrival time is defined as the time for the water to reach its maximum flood depth. As can be seen from the inundation maps, the flooding extents vary based on the breach location, especially between breach locations, 1, 2, and 3 and 4. A significant portion of the breach flood wave is concentrated to the north of State Road 70 and flooding does not reach the Brighton Indian Reservation.

Figure A-14 through Figure A-17 show the difference in maximum depths between the 100-year, 72-hour dam breach condition and non-breach conditions at breach locations 1 through 4.

Figure A-19 through Figure A-22 show the difference in maximum depths between the PMP breach condition and non-breach condition at breach locations 1 through 4.

These figures, **Figure A-14** through Figure A-22, exclusively display the increase in flood depths resulting from the breach flood wave.

Table 5 summarizes the eventual peak discharge into the model domain resulting from a breach at each of the breach locations. The peak discharge at breach locations 1 and 2 are approximately 30,000 to 50,000 cfs lower than the other two breach locations because the terrain at the toe of the dam at breach location 1 and 2 is 6 to 8 feet higher than at breach locations 3 and 4.

Table 5. Summary of Breach Peak Discharges for each LOCAR Alt1 Dam Breach Models

Breach Location	Sunny Day Piping Peak Discharge into Model Domain (cfs)	100-year, 72-hour Piping Peak Discharge into Model Domain (cfs)	PMP Piping Peak Discharge into Model Domain (cfs)
Location 1	51,500	56,417	74,386
Location 2	71,048	76,478	95,782
Location 3	104,642	111,982	137,203
Location 4	105,663	112,474	137,045

5.1 Location 1

The maximum depths from a Sunny Day dam breach at Location 1 are shown in Figure A-1. The depths greater than 15 feet inside C-41A, C-41, C-40, and C-38 are indicative of the canal capacity to hold the breach flood wave without overtopping. The inundation is contained to the north of C-41A and is concentrated immediately downstream of the breach location, around the perimeter canal, along the State Road 70, and towards Istokpoga Canal. The residential communities along the County Road 721 and immediately downstream of the

breach location may be impacted by flooding depths ranging from 2.1 – 5 feet. The communities to the south of County Road 621 and north of State Road 70 may be impacted by flooding depths of 0.6 – 1.5 feet.

Most of the inundation area between the Kissimmee River and C-41A will experience 0.4 to 0.7 feet/second flood wave velocities (Figure A-2). The highest velocities occur near the dam breach and inside C-38 with maximum velocities decreasing with distance from the breach location. The velocities are typically less than 0.7 feet/second in the inundated area.

The maximum flood depths are estimated to reach the residential community immediately downstream of the dam breach location in 0.0 – 0.5 days (0 to 12 hours), and by 0.6 – 1 days (14.4 – 24 hours) at the communities along County Road 721. It will take 1.6 – 2 days (38.4 – 48 hours) for the maximum flood depth to reach communities along State Road 70, and 3.1 – 5 days (74.4 – 120 hours) at communities immediately to the south of County Road 621 (Figure A-3).

An increase in flood depths by 0 to 0.5 feet caused by 100-year, 72-hour breach at Location 1 is concentrated downstream of C-41A, specifically in Brighton Valley Impoundment, Brighton Indian Reservation, and the areas between L-61/L-60 and HDD (Figure A-14). Residential communities immediately downstream of Lake Istokpoga and downstream of the breach Location 1 will experience an increase in flood depths by greater than 2 feet. An increase in flood depths caused by the breach flood wave by 0.6 to 1 feet will occur at communities along County Road 721, and to the north of State Road 70. The increase in depths by 0 to 0.5 feet in most of the model domain downstream of C-41A could be caused by a slight change in flood arrival times of peak discharges caused by the breach flood wave.

Similar to what was observed in Figure A-14, Figure A-19 indicates that the increase in flood depths by 0 to 0.5 feet in Brighton Valley Impoundment, Brighton Indian Reservation, areas between L-61/L-60 and along HDD, and along Kissimmee River from downstream of State Road 70 could be due a slight change in flood arrival times of peak discharges caused by the breach flood wave. An increase of flood depths by greater than 2 feet is concentrated immediately downstream of the breach Location 1.

5.2 Location 2

The maximum depths from a Sunny Day dam breach at Location 2 are shown in Figure A-4, where the flooding is concentrated immediately downstream of the breach location spreading along C-41A, towards the “hammock” area, and to the south of State Road 70. There will not be any flooding south of C-41A. The residential communities downstream of the breach location along County Road 721, and on the south side of the Kissimmee River will be impacted by 2.1 to 5 feet of floodwater, and the residential communities along State Road 70 by 1.6 to 2 feet. There is no overtopping of State Road 70 along Kissimmee River; however, the bridge may get overtopped by 0.4 feet along C-41A under the Sunny Day dam breach scenario.

The highest velocities occur near the dam breach (less than 3.1 feet/second), with maximum velocities decreasing with distance from the breach location. The velocities at few locations between State Road 70 and County Road 721 will range from 1.1 to 2.0 feet/second (Figure A-5). Most of the residential communities located within the flood zone may be impacted by flood wave velocities in the range of 0.1 to 2.0 feet/second.

The maximum flood depths will reach the residential communities along County Road 721 in 0 to 0.5 day (0 to 12 hours) and around 0.6 to 1 day (14.4 to 24 hours) at communities along State Road 70. The residential communities to the east of C-38 may see maximum flood depths in 1.1 – 1.5 days (26.4 – 36 hours) (Figure A-6).

Figure A-15 shows the difference in maximum depths between 100-year, 72-hour dam breach condition and non-breach condition at Location 2. Most of the model domain, downstream of C-41A, Brighton Valley Impoundment, Brighton Indian Reservation, and northwest of the reservoir, has an increase in depths due to breach by 0 to 0.5 feet of water. This difference in depths could be caused by a slight change in flood arrival times of peak discharges caused by the breach flood wave. An increase in flood depths by less than 2 feet can be seen immediately downstream of the breach location, and along State Road 70 and along Kissimmee River, immediately downstream of the breach Location 2.

An increase in flood depths by 0 to 0.5 feet caused by the PMP breach at Location 2 are concentrated downstream of C-41A, specifically in Brighton Valley Impoundment, a few areas inside Brighton Indian Reservation, and the areas between L-61/L60 and HHD and along the Kissimmee River (Figure A-20). Most of the breach flood wave will be concentrated immediately downstream of the breach Location 2 until it reaches the Kissimmee River. The residential communities within this inundation area will experience an increase in flood depths by 1.1 to 1.5 feet caused by the breach.

5.3 Locations 3 and 4

The maximum depths from breach locations 3 and 4 (south breaches) from the Sunny Day can be found in Figure A-7 and Figure A-10, respectively. The flooding extent from breach Location 4 is slightly larger than Location 3 because of the approximately 1% increase in peak discharge from the breach at Location 4 compared to Location 3 (Table 5). The flood extent from breach Location 4 is the largest within the Brighton Valley Impoundment and along County Road 621 and is estimated to be flooded by up to 2.1 to 5 feet of water. Maximum flood depths are observed immediately downstream of the Location 4, inside the “hammock” area, with flood depths ranging from 10.1 to 15.0 feet. The section of C-41A north of Brighton Valley Impoundment is overtopped because of the proximity of breach locations 3 and 4 to the canal. None of the residential communities along the County Road 721 would be flooded, with the exception of one community closest to State Road 70 which may see flood depths of 0 – 0.5 feet. State Road 70 along Kissimmee River will not overtop from breach locations 3 and 4. However, the State Road 70 bridge crossing at C-41A is estimated to be overtopped from a breach at locations 3 and 4.

A portion of the Brighton Valley Impoundment, area on either side of State Road 70, along C-41A towards Lake Istokpoga, and residential communities along State Road 70 and to the south may experience flood waters at maximum velocities ranging from 0.4 to 0.7 feet/second from the dam breach at locations 3 and 4 (Figure A-8 and Figure A-11). Additionally, the area along C-41A (north of the canal towards the reservoir) may experience flood waters at maximum velocities of 1.1 to 2.0 feet/second from dam breach at locations 3 and 4.

Maximum flood depths from the breach at Location 3 may reach portions of northern Brighton Valley Impoundment in 0 to 0.5 days (0 to 12 hours), central portions in 0.6 – 1 days (14.4 – 24 hours), and southern portions in 1.6 – 2 days (38.4 – 48 hours), respectively. Most of the area along State Road 70 and portions of the area along C-41A towards Istokpoga Canal will see the maximum flood water within 0.6 to 1 days (14.4 to 24 hours) (Figure A-9). The residential communities along State Road 70 and immediately south of the Istokpoga Canal may experience maximum flood depths in 1.1 to 1.5 days (26.4 to 36 hours) (Figure A-12).

An increase in flood depths by 0 to 0.5 feet caused by 100-year, 72-hour breach at locations 3 and 4 are concentrated along the Kissimmee River, to the south and west of Brighton Valley Impoundment, a portion of Brighton Indian Reservation, and areas between L-61/L-60 and HHD (Figure A-16 and Figure A-17). The

“hammock” area to the south of reservoir will experience greater than 2 feet of increased depth due to a breach. The breach flood wave will increase the flood depths by greater than 2 feet in the Brighton Valley Impoundment and to the south of State Road 70. The increase in depths along HHD, Kissimmee River, and C-40 and C-41 could be caused by a slight change in flood arrival times of peak discharges caused by the breach flood wave.

Most of the model domain along C-41, C-40, and the area between L-61 and HHD has an increase in flood depths by less than 0.5 feet caused by the PMP breach at locations 3 and 4 (Figure A-21 and Figure A-22). The portion of the model domain in Glades County, between L-60 and HHD, with an increase in flood depths by 0.6-1 feet, could be caused by overtopping of portion of C-40 and C-38 and a slight change in flood arrival times of peak discharges caused by the breach flood wave. The maximum increase in flood depths is observed immediately to the south of reservoir in the “hammock” area and inside Brighton Valley Impoundment with an increase in flood depths greater than 2 feet.

6.0 Next Steps

As part of Pre-Construction Engineering and Design (PED), additional dam breach modeling will occur. This modeling may include sensitivity runs to evaluate the sensitivity of model results to the conceptualization and parameterization and more detailed evaluations of flow and stage in key locations, such as the C-41A.

7.0 References

Froehlich, David C. 2008. Embankment Dam Breach Parameters and their Uncertainties. ASCE, Journal of Hydraulic Engineering, Vol. 134, No. 12, December 2008, pages 1708-1721.

SFWMD. South Florida Environmental Report (SFER) 2022.

https://www.sfwmd.gov/sites/default/files/2022_sfer_highlights_Final_LR.pdf. Accessed on May 21, 2023.

USACE 2018. Technical Manual for Dams: Mapping, Modeling, and Consequences. Prepared by MMC Production Center. October 2018.

Appendix A: Inundation Maps

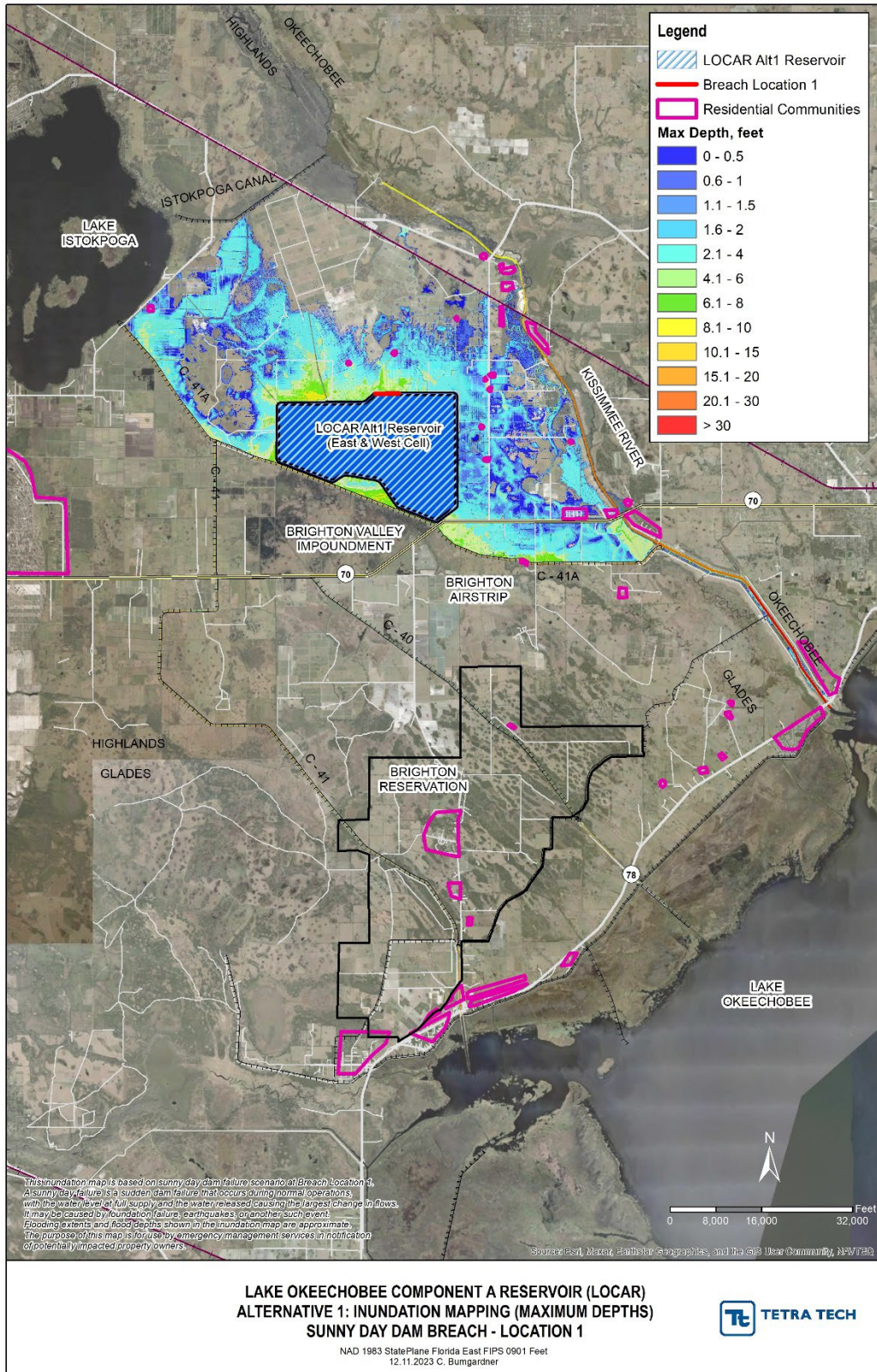


Figure A-1 Maximum Depths from a Sunny Day Dam Breach at Location 1

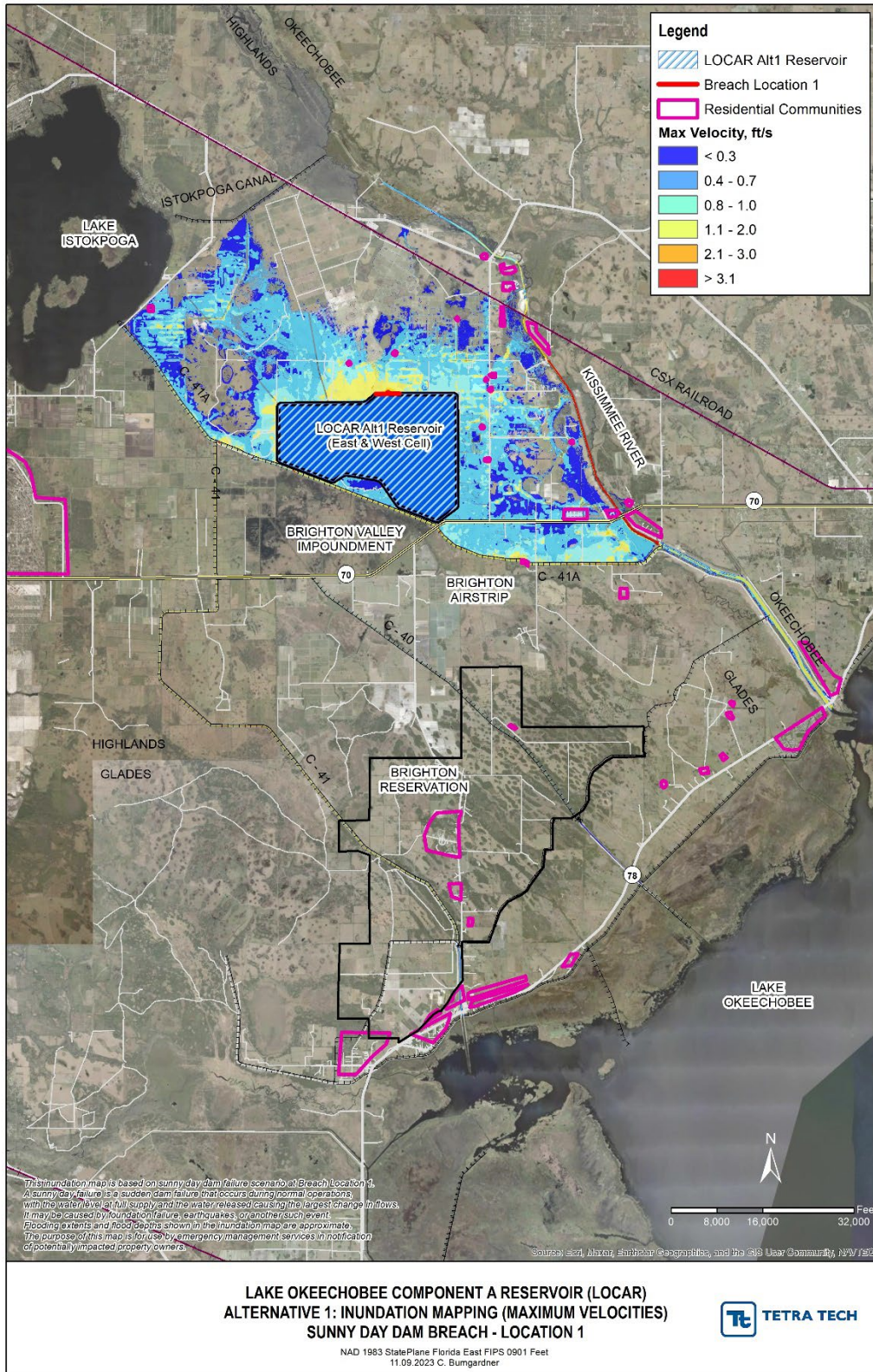


Figure A-2 Maximum Velocities from a Sunny Day Dam Breach at Location 1

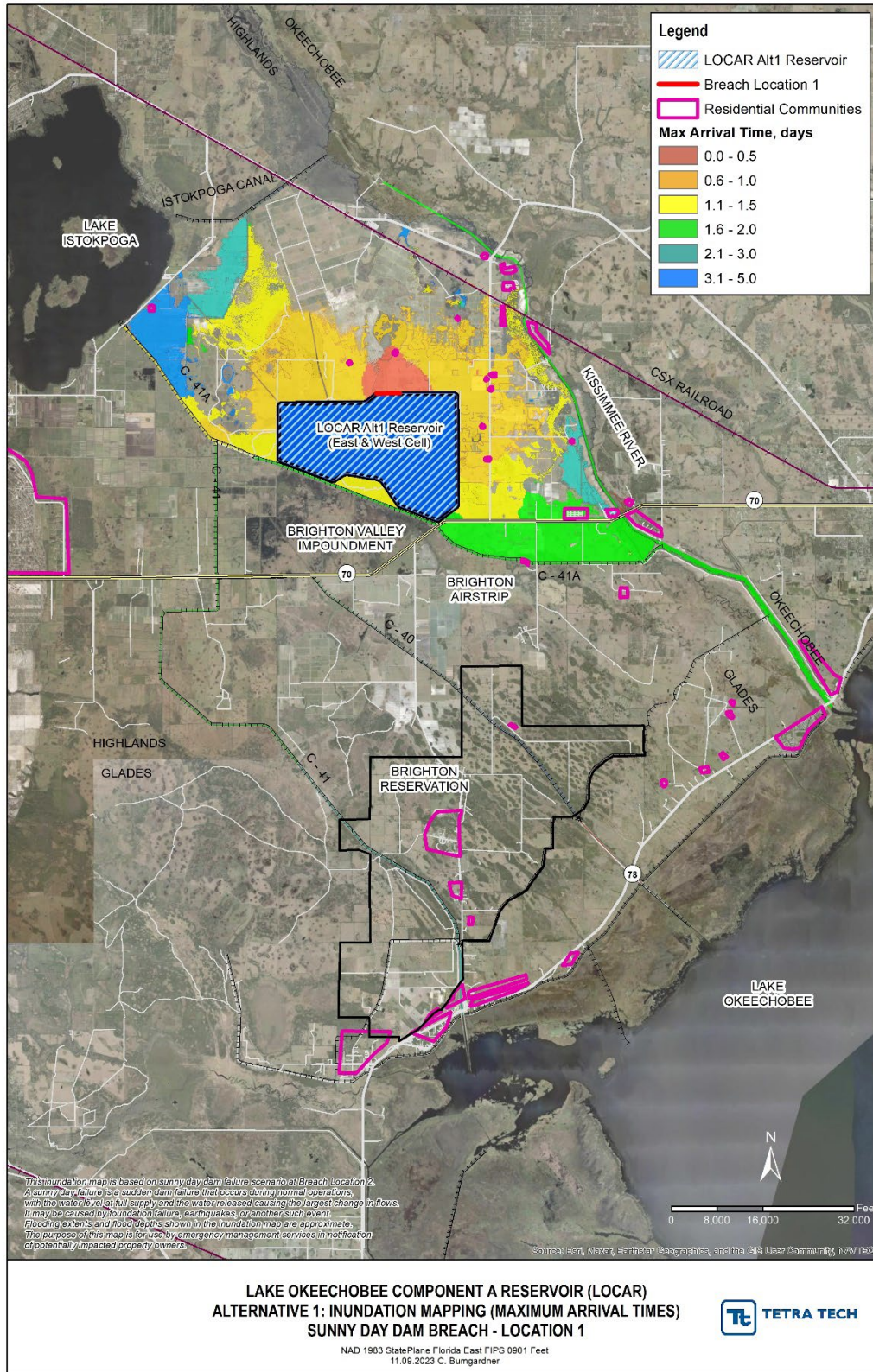


Figure A-3 Time to Maximum Depth from a Sunny Day Dam Breach at Location 1

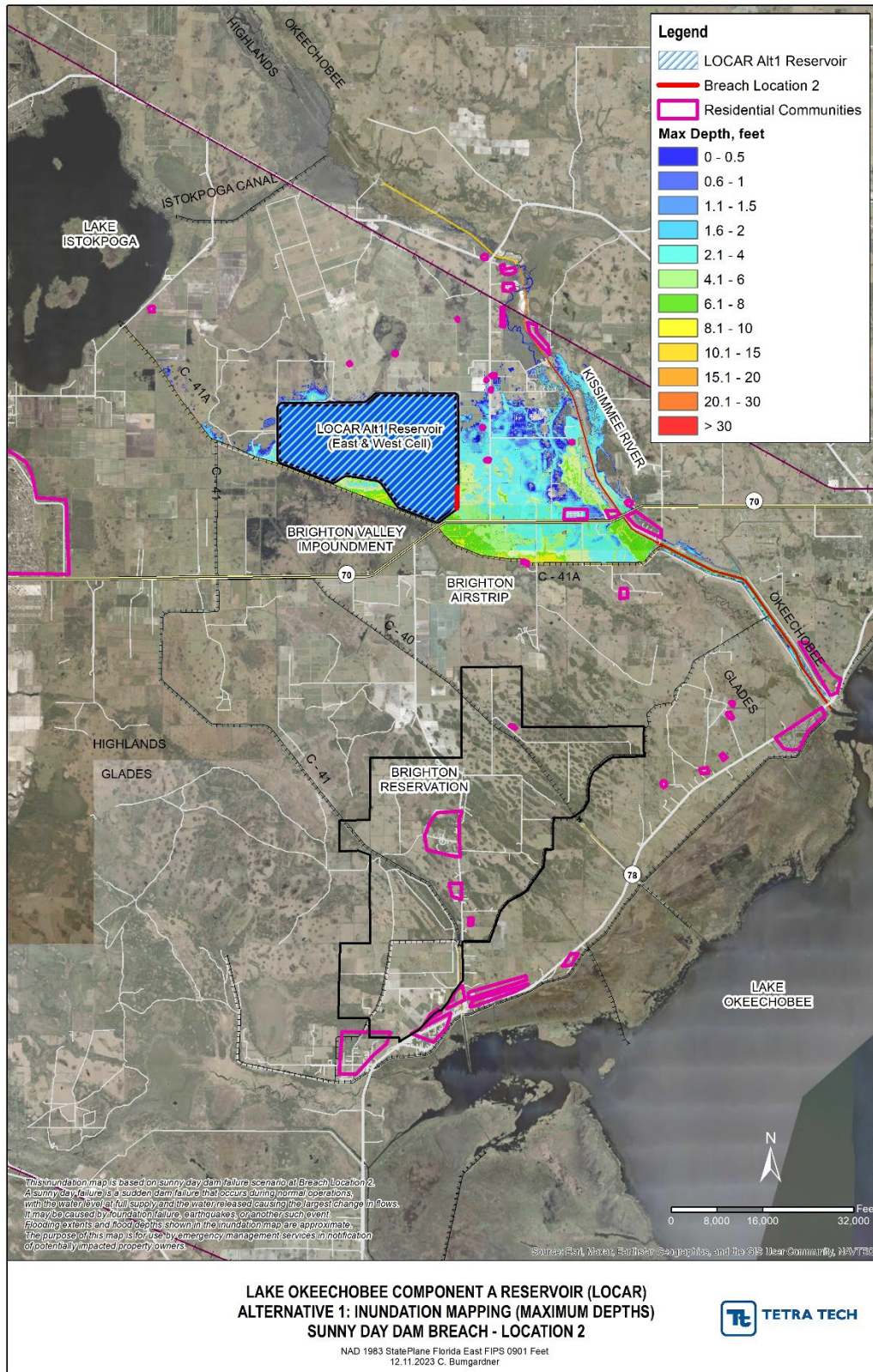


Figure A-4 Maximum Depths from a Sunny Day Dam Breach at Location 2

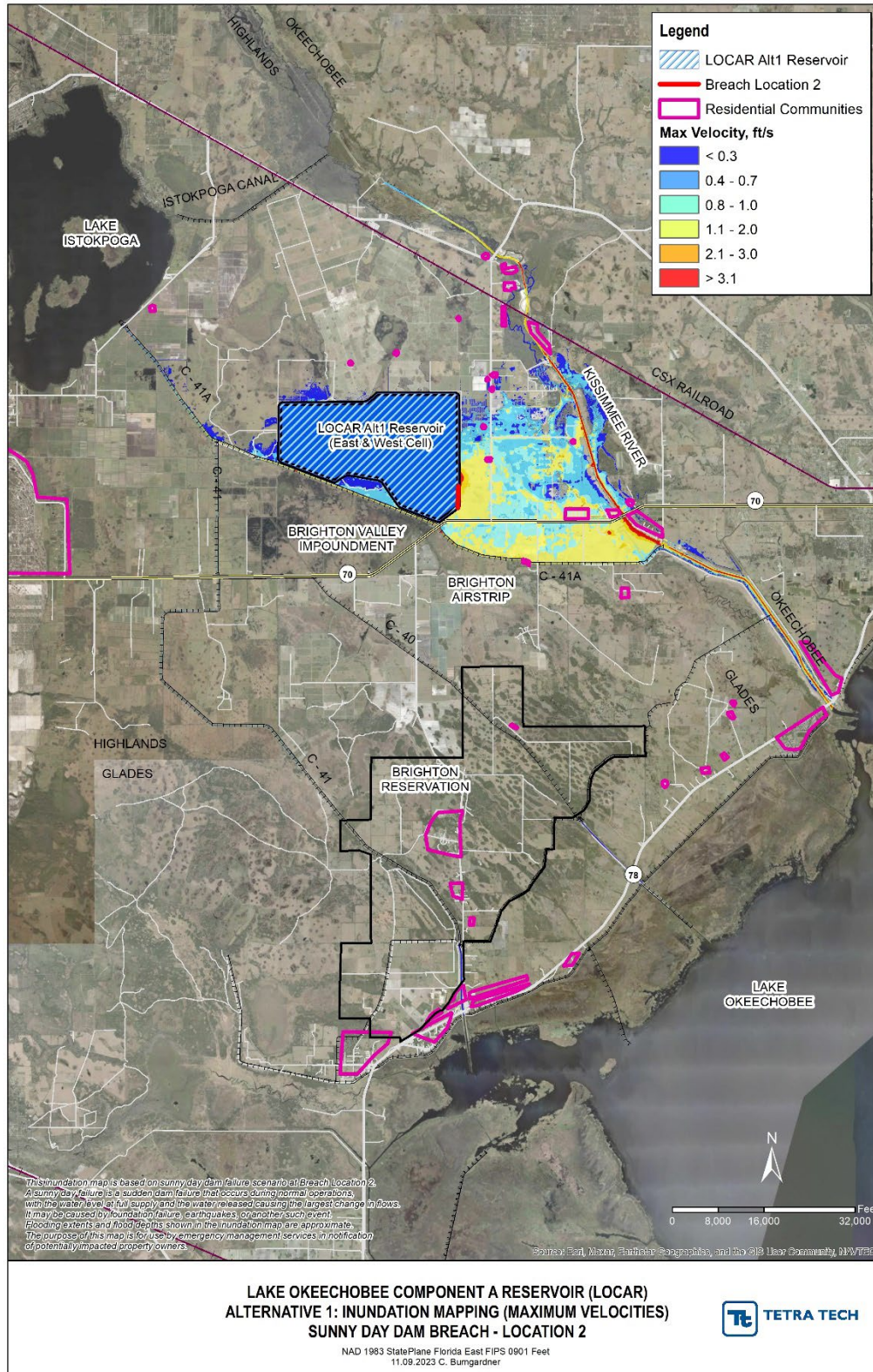


Figure A-5 Maximum Velocities from a Sunny Day Dam Breach at Location 2

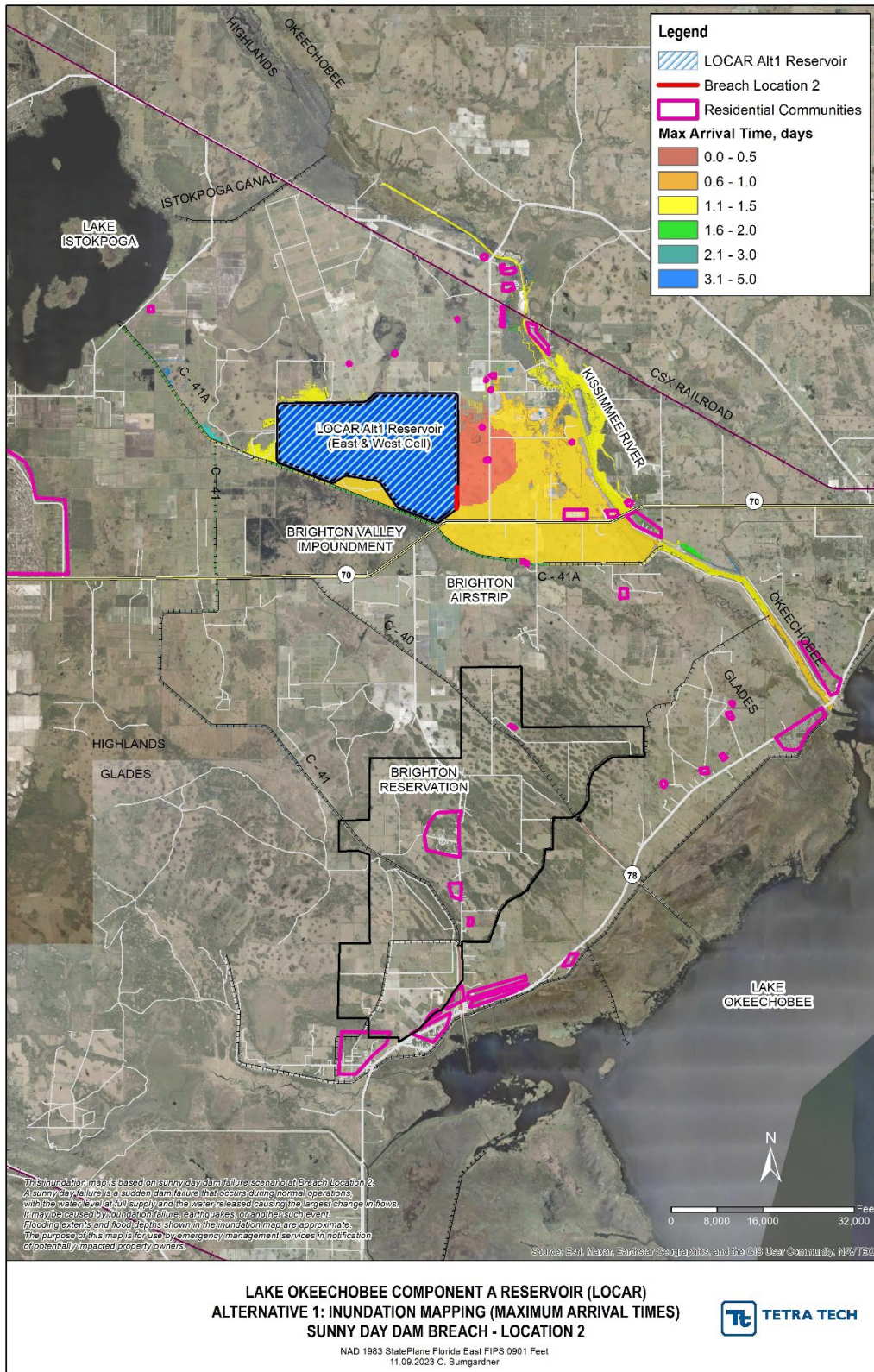


Figure A-6 Time to Maximum Depth from a Sunny Day Dam Breach at Location 2

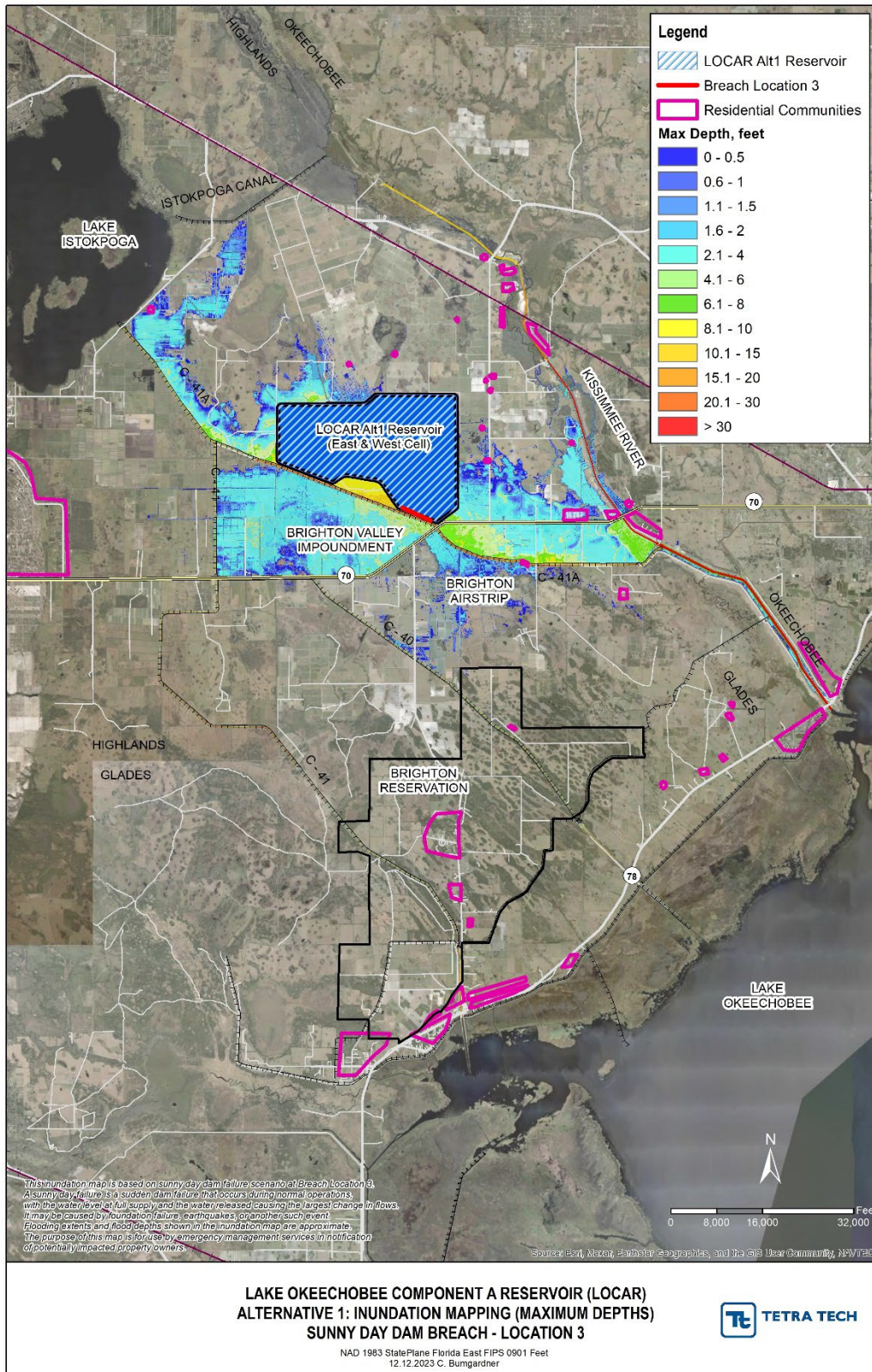


Figure A-7 Maximum Depths from a Sunny Day Dam Breach at Location 3

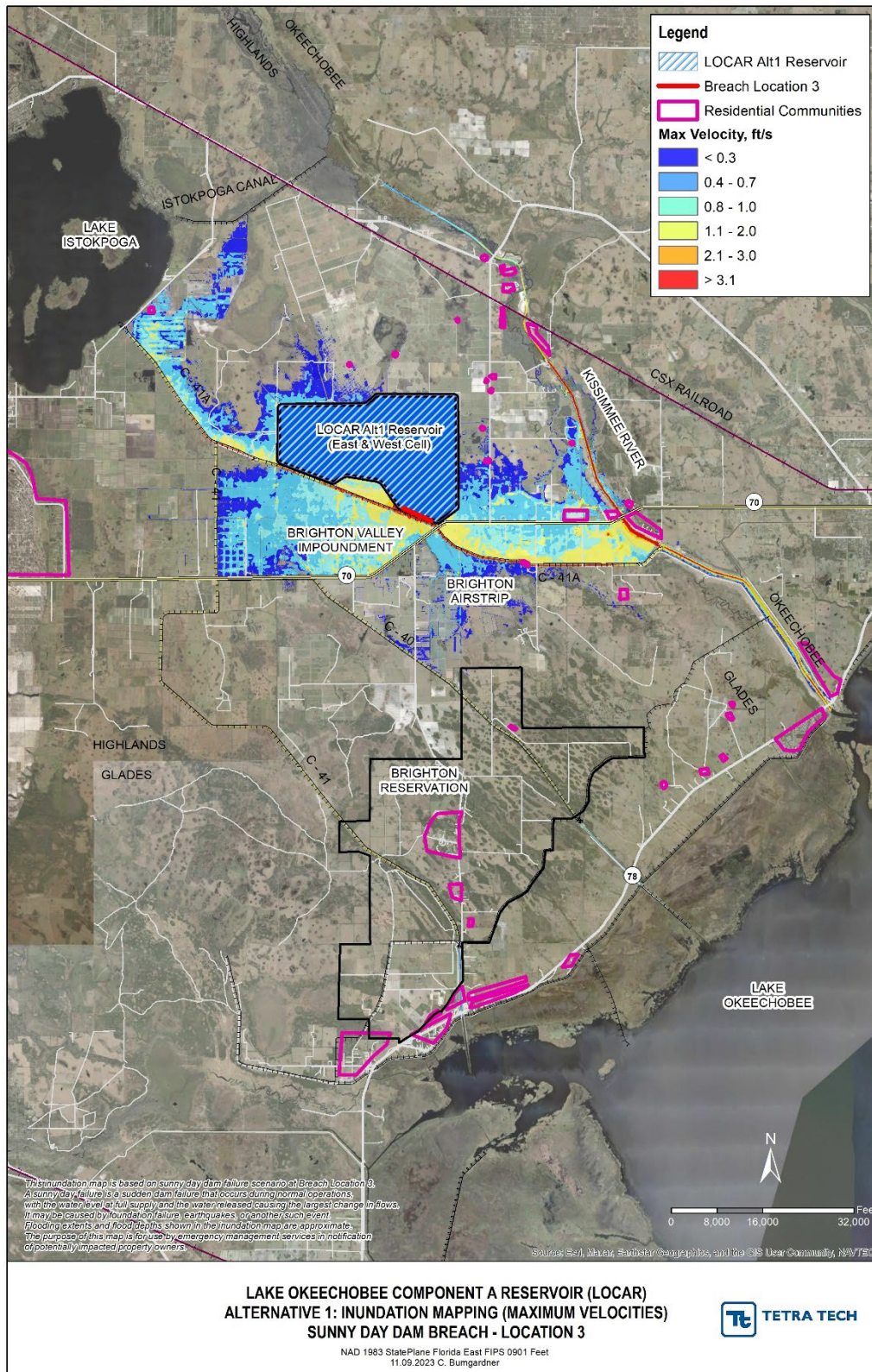


Figure A-8 Maximum Velocities from a Sunny Day Dam Breach at Location 3

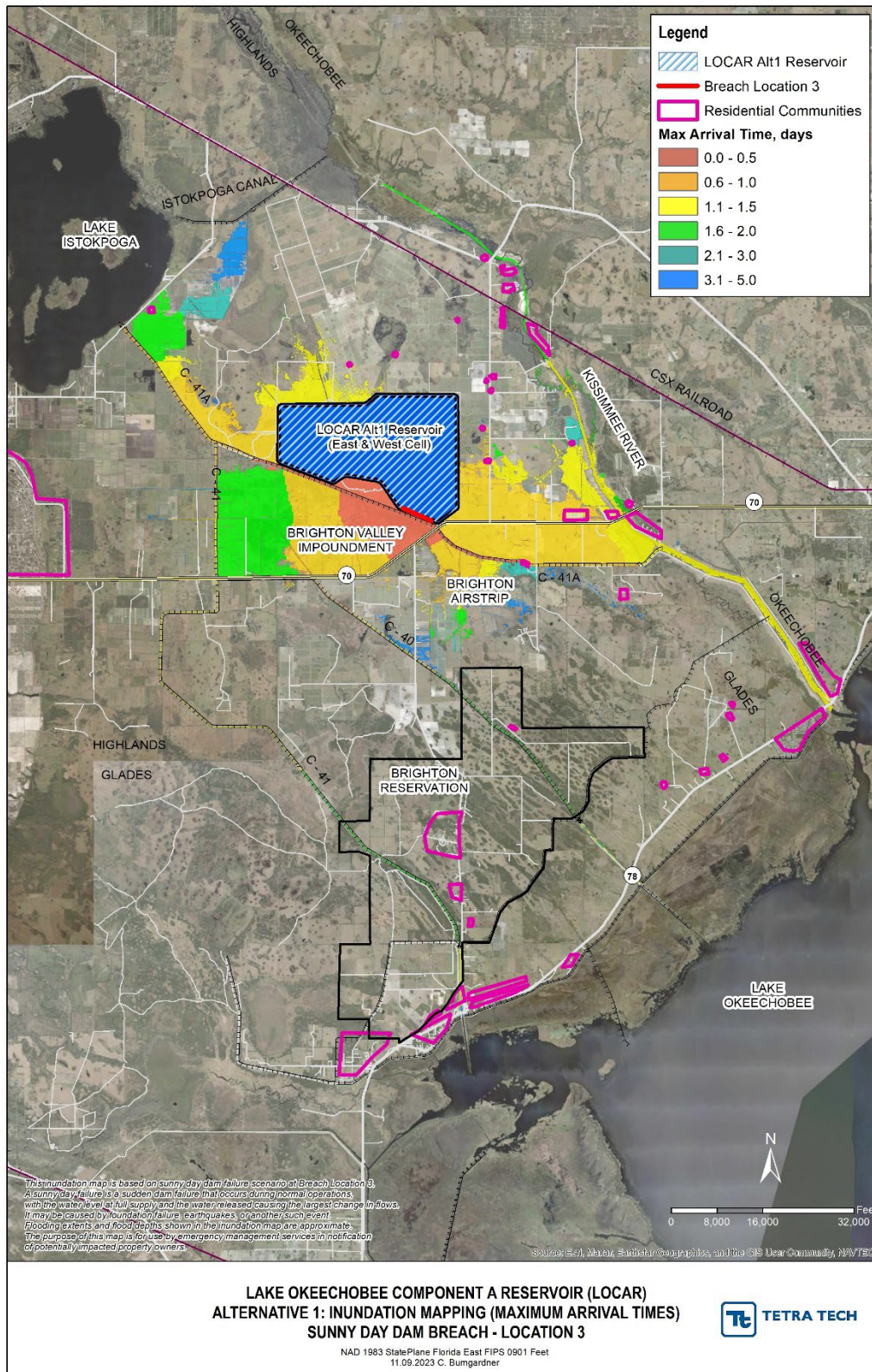


Figure A-9 Time to Maximum Depth from a Sunny Day Dam Breach at Location 3

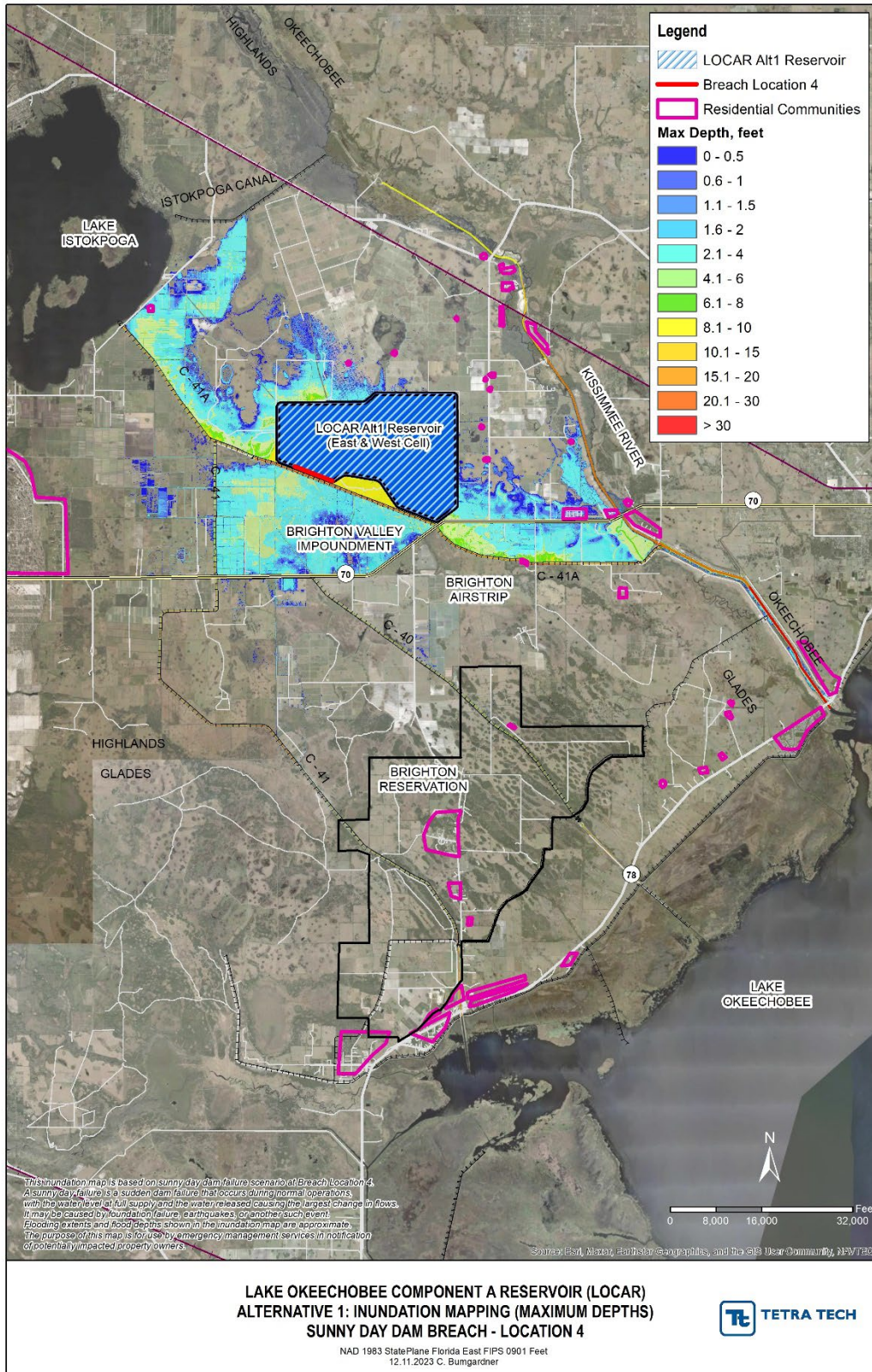


Figure A-10 Maximum Depths from a Sunny Day Dam Breach at Location 4

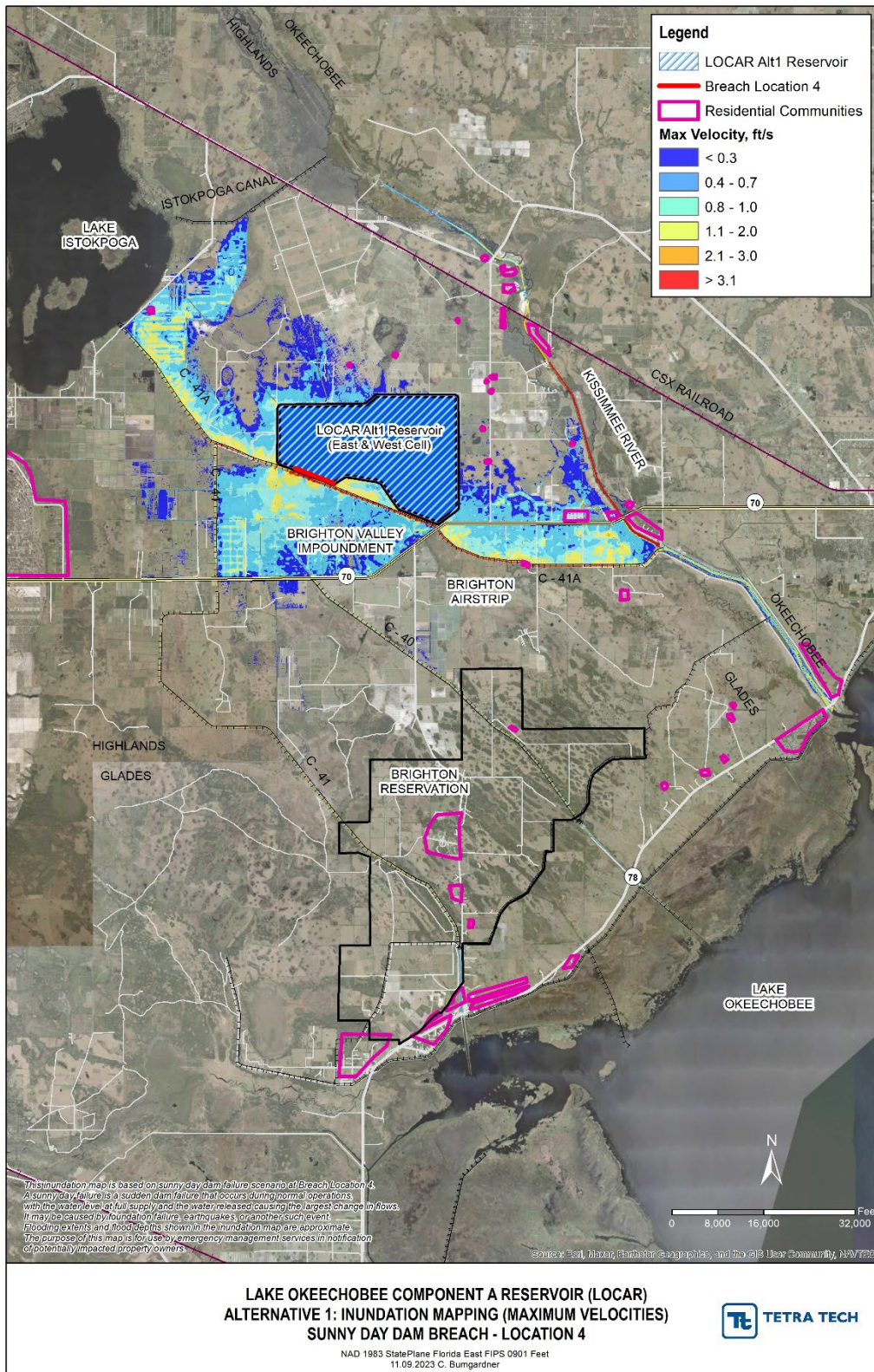


Figure A-11 Maximum Velocities from a Sunny Day Dam Breach at Location 4

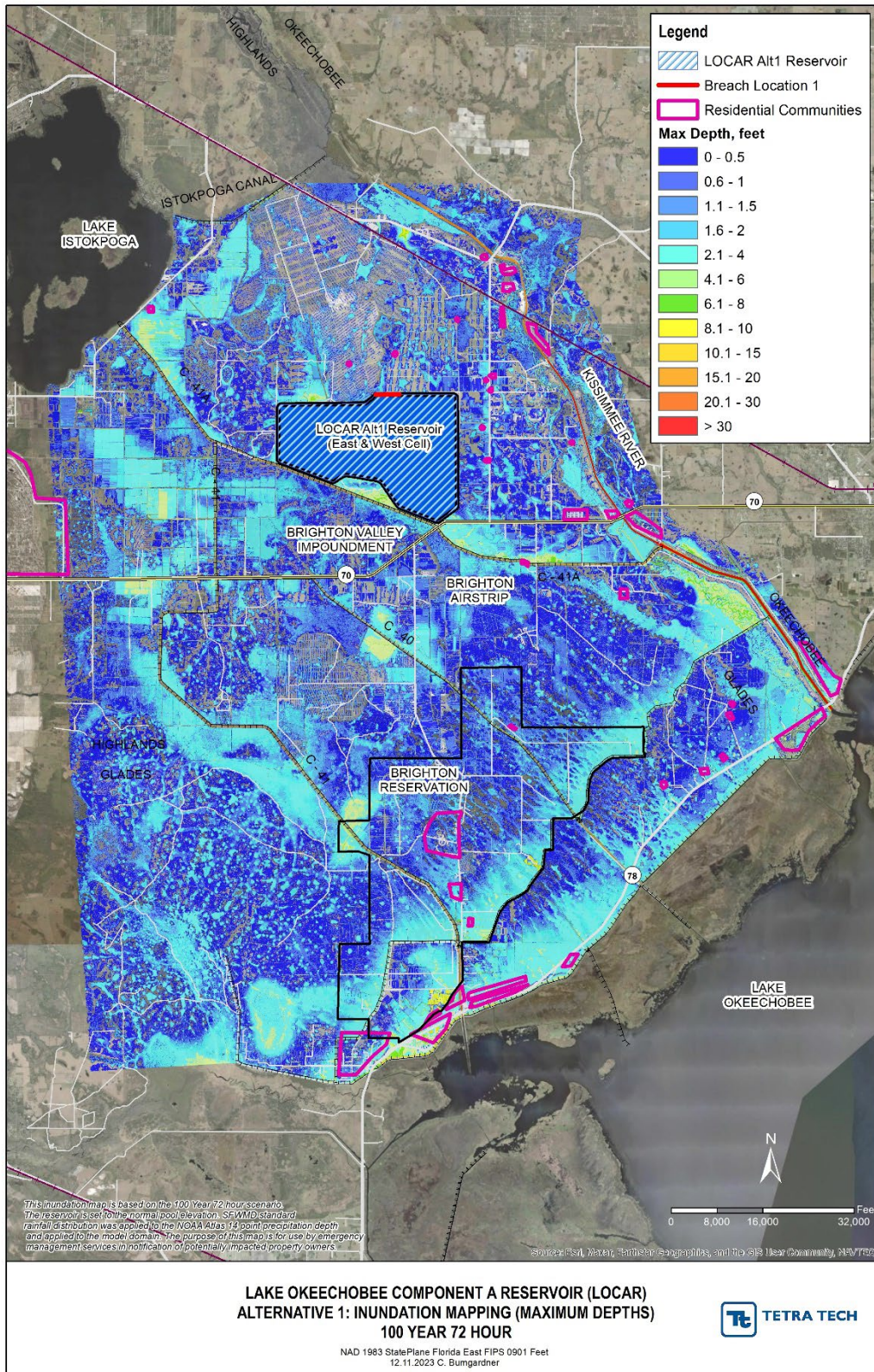


Figure A-13 Maximum Depths from a 100-year, 72-hour Storm

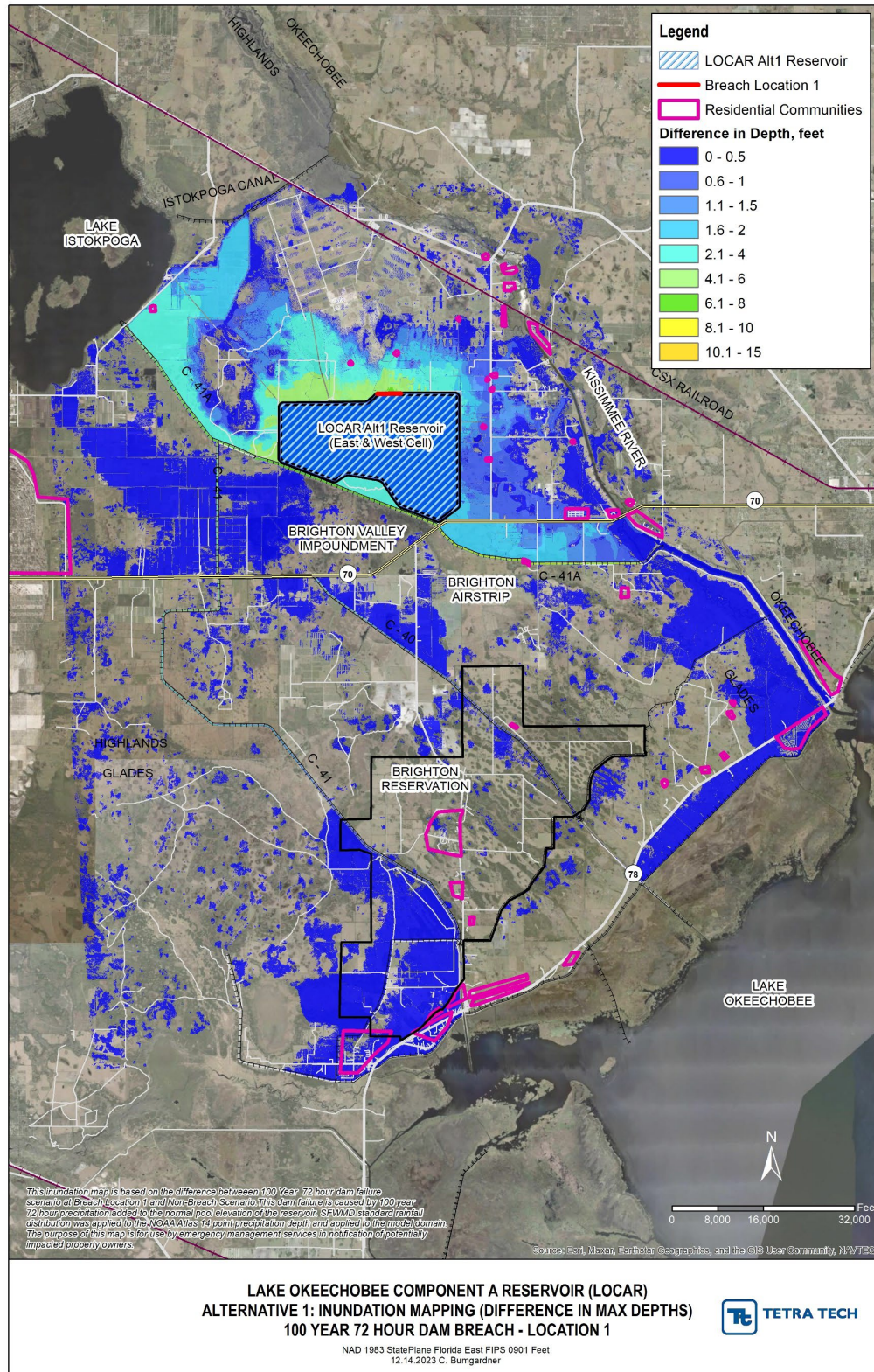


Figure A-14 Difference in Maximum Depths from a 100-year, 72-hour Breach and Non-Breach Conditions at Location 1

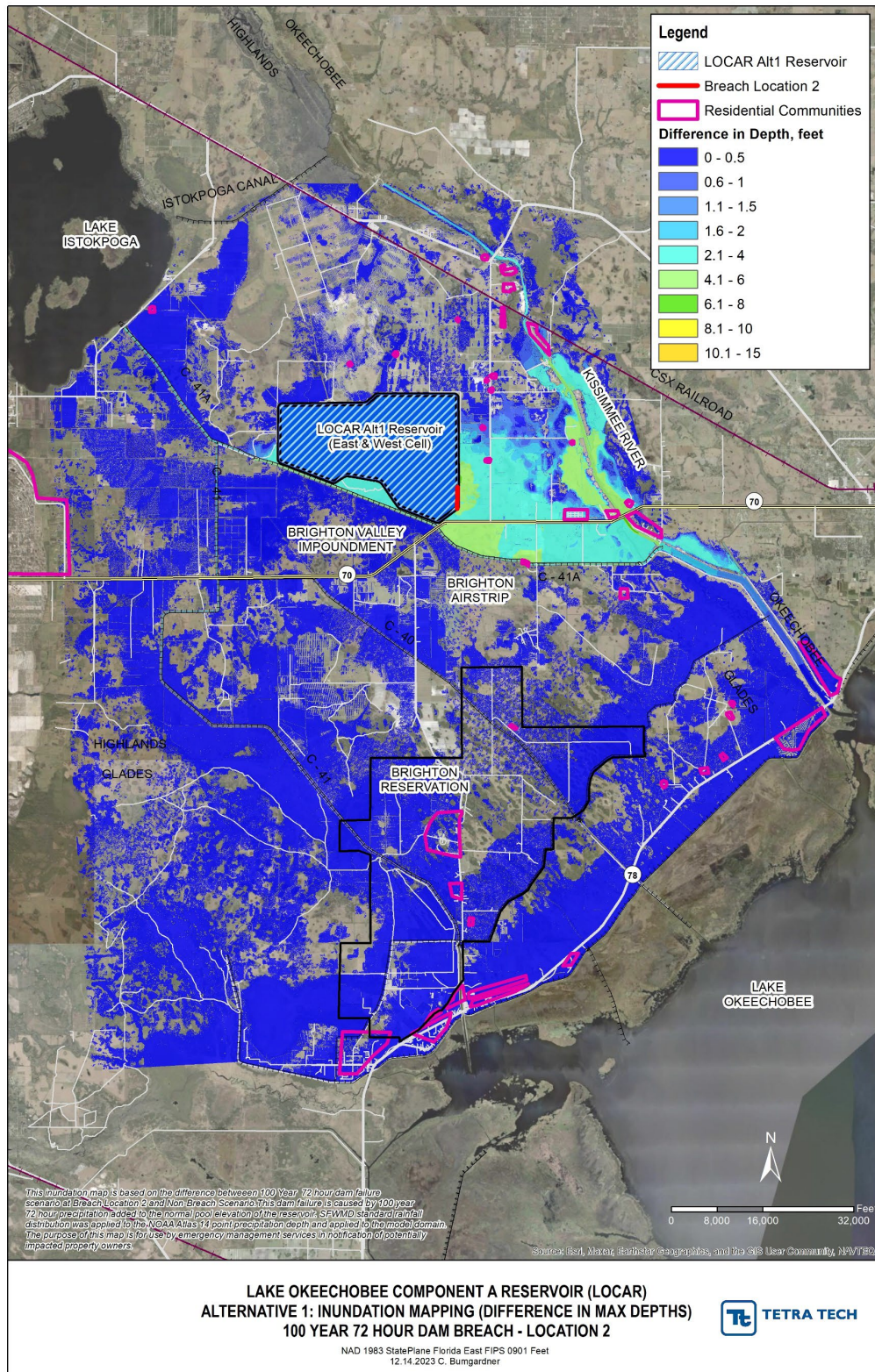


Figure A-15 Difference in Maximum Depths from a 100-year, 72-hour Breach and Non-Breach Conditions at Location 2

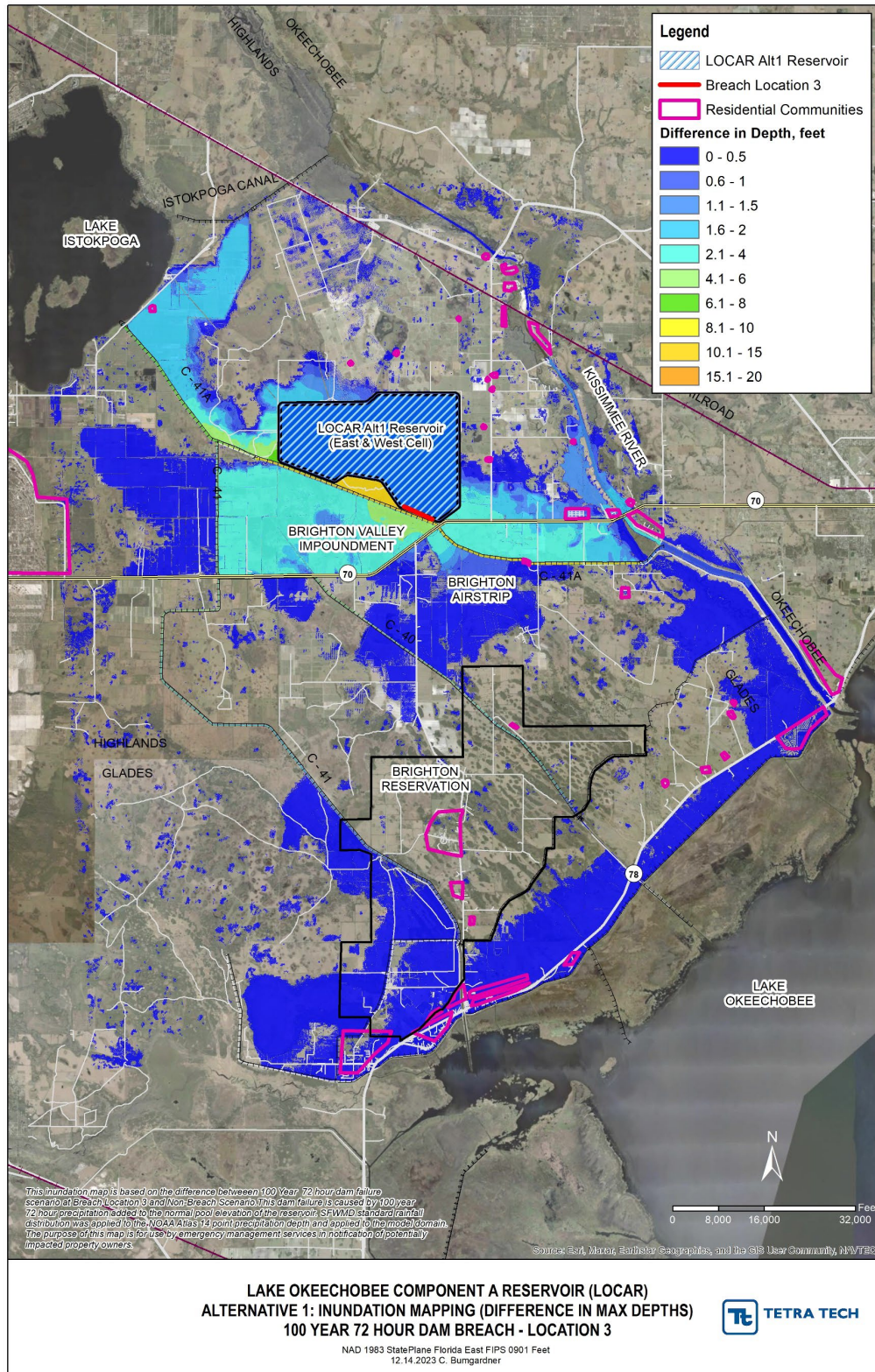


Figure A-16 Difference in Maximum Depths from a 100-year, 72-hour Breach and Non-Breach Conditions at Location 3

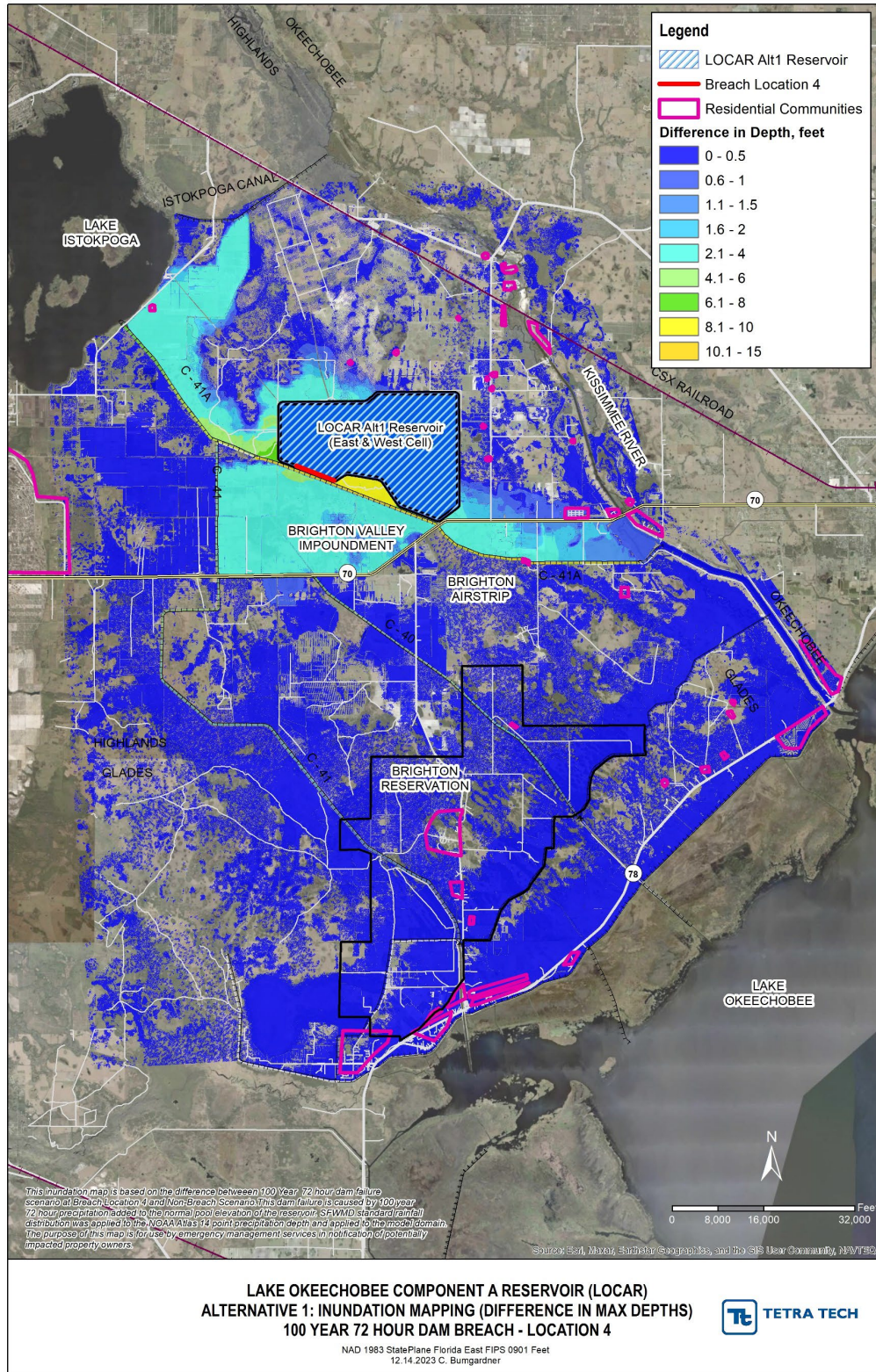


Figure A-17 Difference in Maximum Depths from a 100-year, 72-hour Breach and Non-Breach Conditions at Location 4

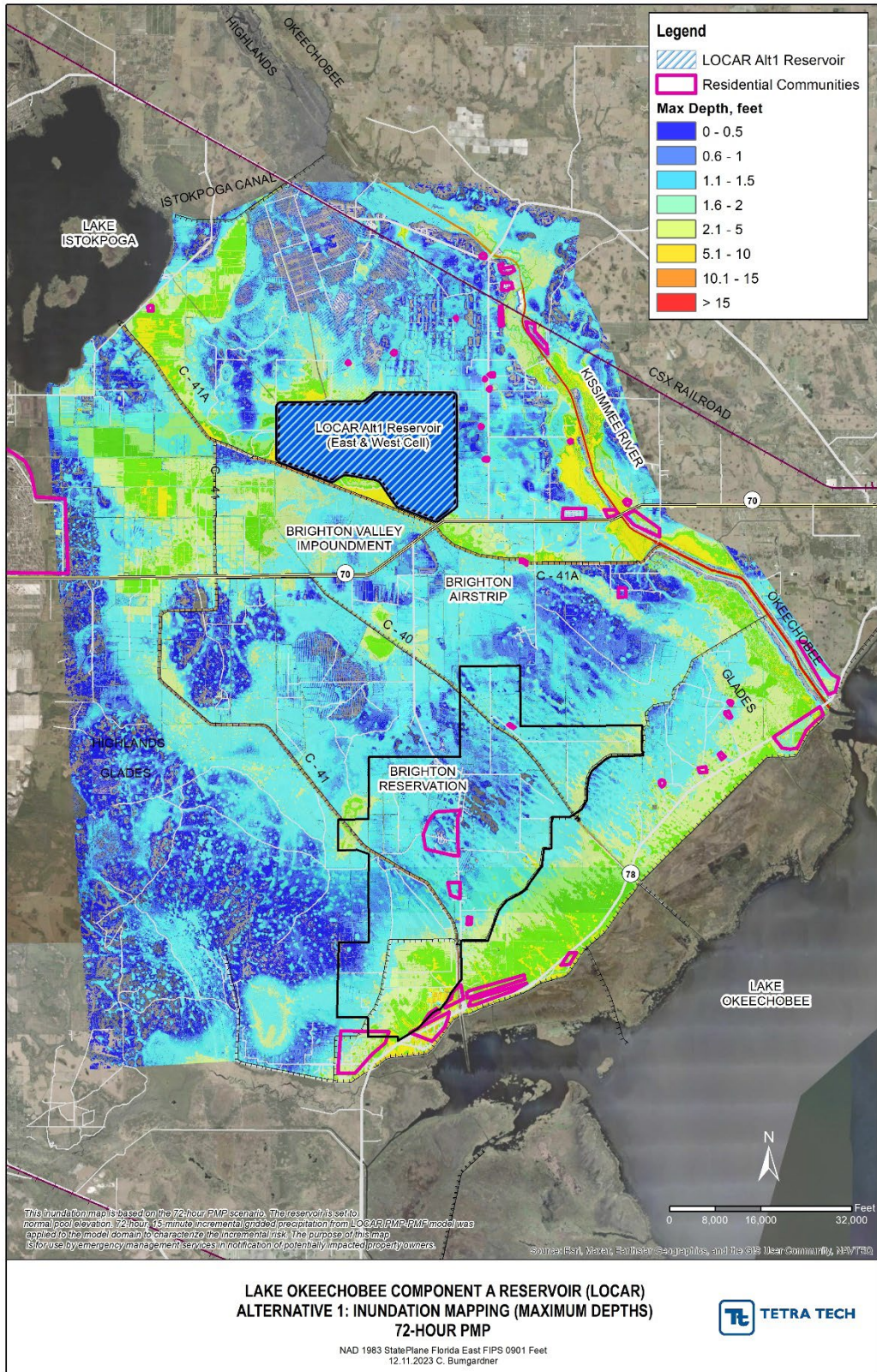


Figure A-18 Maximum Depths from a PMP Storm

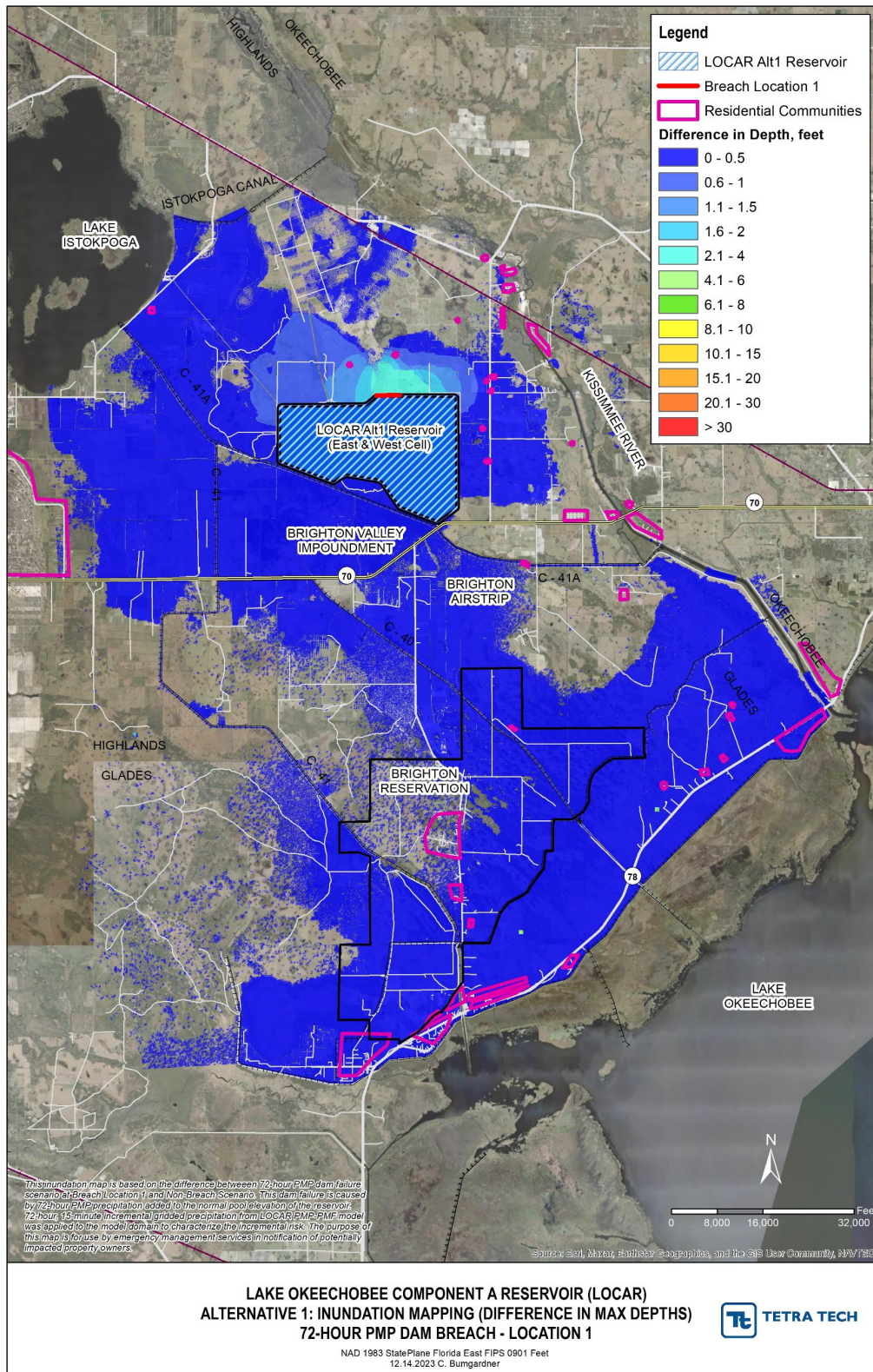


Figure A-19 Difference in Maximum Depths from a PMP Breach and Non-Breach Conditions at Location 1

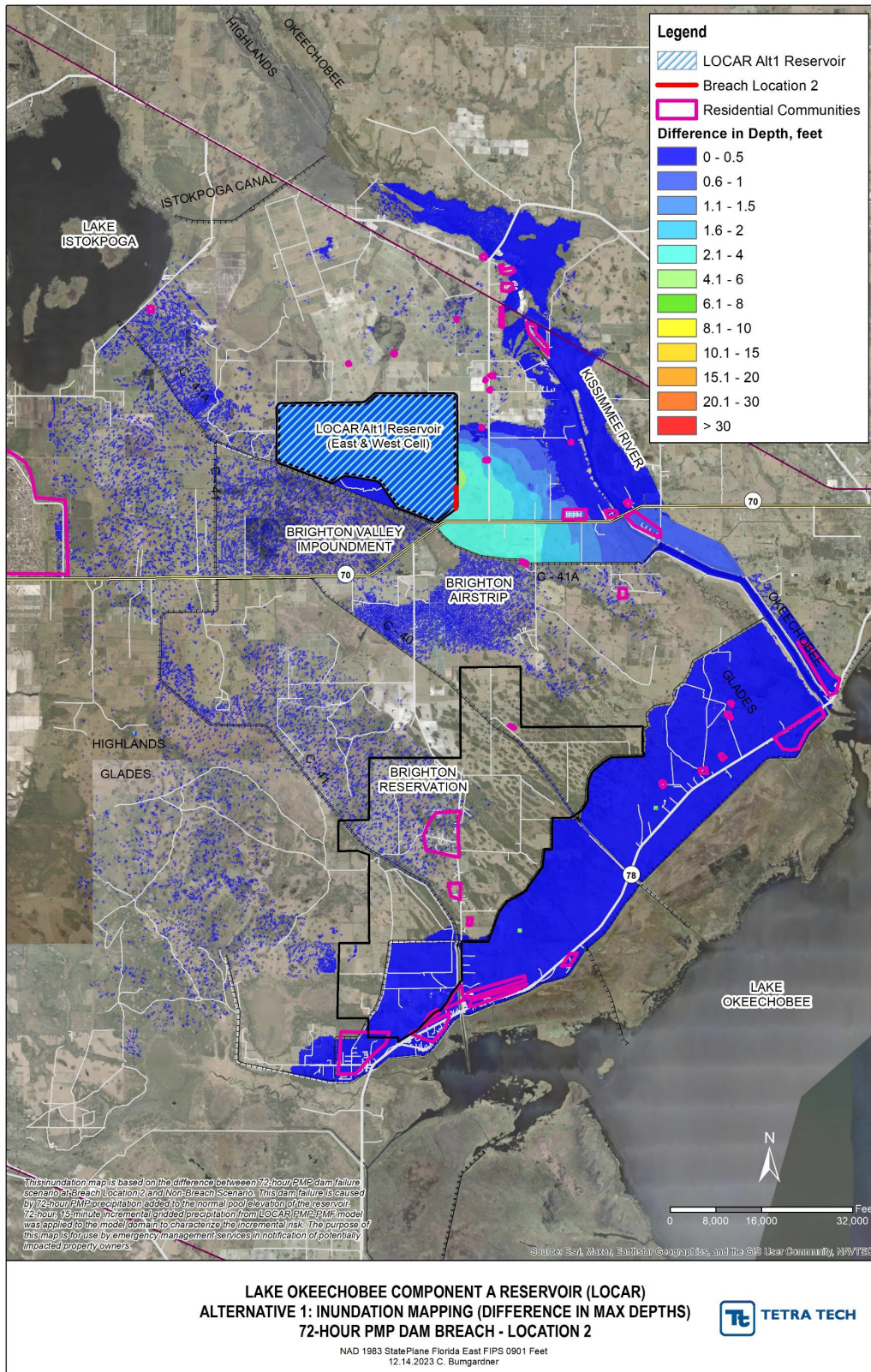


Figure A-20 Difference in Maximum Depths from a PMP Breach and Non-Breach Conditions at Location 2

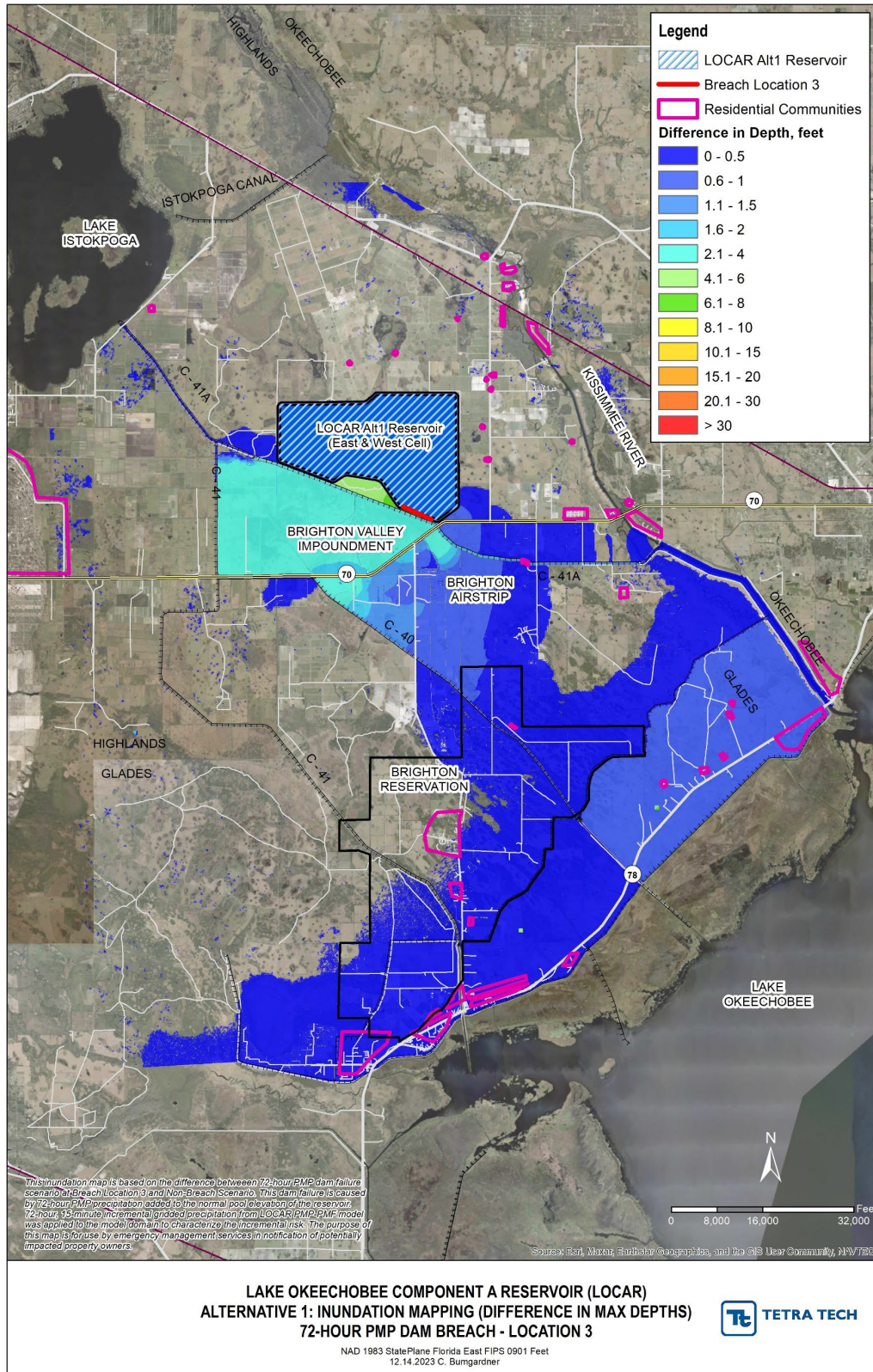


Figure A-21 Difference in Maximum Depths from a PMP Breach and Non-Breach Conditions at Location 3

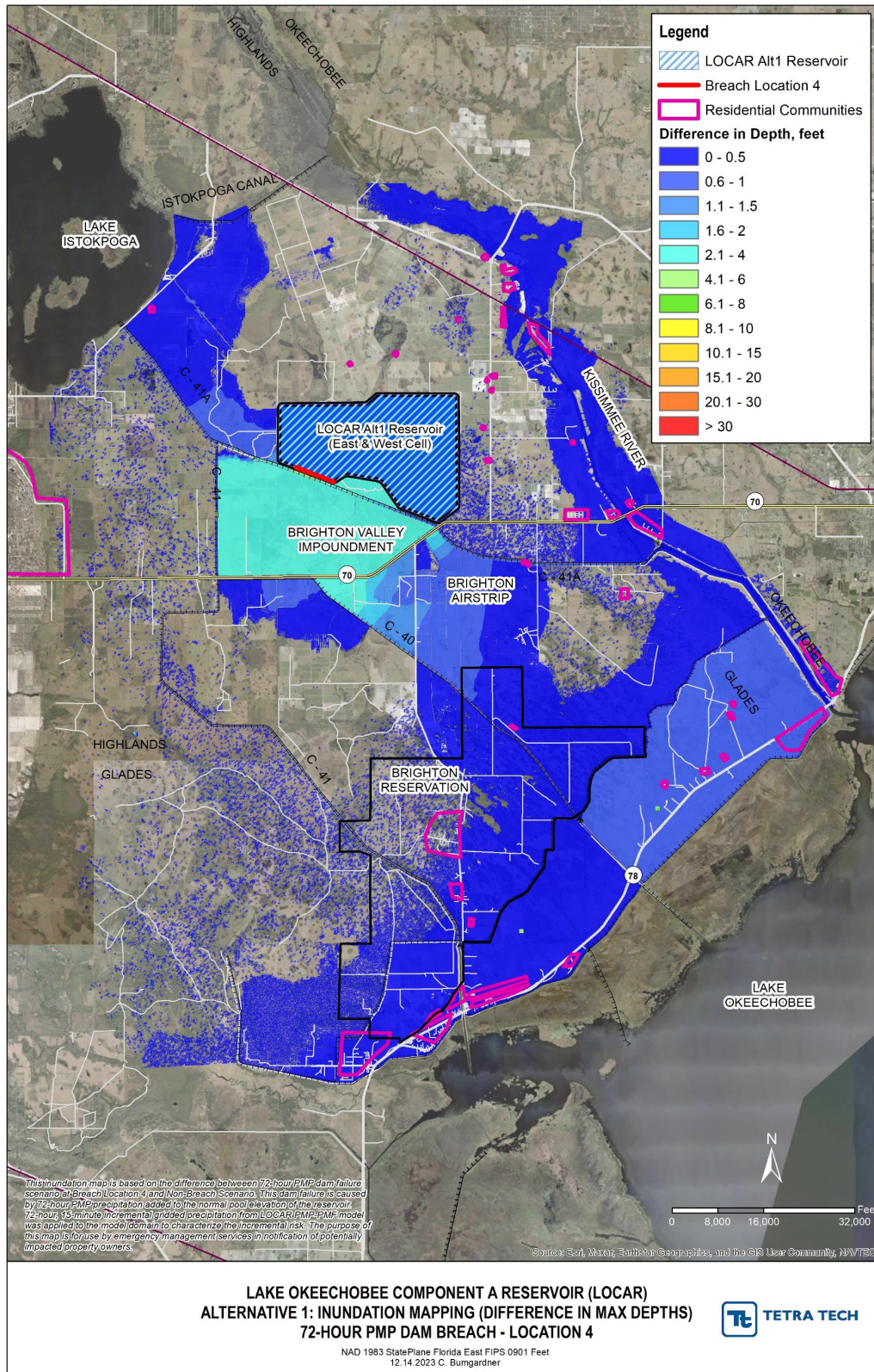


Figure A-22 Difference in Maximum Depths from a PMP Breach and Non-Breach Conditions at Location 4

ANNEX B-1
LOCAR Subsurface Soil Exploration Report

**Subsurface Soil Exploration
Lake Okeechobee Component A Reservoir (LOCAR)
Highlands County, Florida**

Report Dated August 11, 2023 (Revised February 20, 2024)



Ardaman & Associates, Inc.

CORPORATE HEADQUARTERS

8008 S. Orange Avenue, Orlando, Florida 32809 - Phone: (407) 855-3860 Fax: (407) 859-8121

Branch Office Locations

Florida: Bartow, Cocoa, Fort Myers, Miami, Orlando, Port St. Lucie, Sarasota, Tallahassee, Tampa, West Palm Beach

Louisiana: Baton Rouge, New Orleans, Shreveport

Texas: Houston

MEMBERS:

ASTM International
Society of American Military Engineers
American Council of Engineering Companies



Ardaman & Associates, Inc.

Geotechnical, Environmental and
Materials Consultants

August 11, 2023
Revised February 20, 2024
Ardaman File No. 23-6363

Tetra Tech
759 SW Federal Highway
Stuart, Florida

Attention: Ms. Georgia Vince, P.E.

Subject: Subsurface Soil Exploration
Lake Okeechobee Component A Reservoir (LOCAR)
Highlands County, Florida

Dear Ms. Vince:

As requested and authorized, we have completed a subsurface soil exploration for the subject project. The purposes of performing this exploration were to explore soil stratigraphy and groundwater levels at selected locations within and around the perimeter of the proposed storage reservoir to aid in the design by others. In addition, we have estimated the normal seasonal high groundwater level at the boring locations. This data report documents our findings.

The exploration was performed in two separate phases, with the initial phase occurring in May/June 2023, and the supplemental phase occurring in August 2023.

The information submitted herein is based on the data obtained from the soil borings and soundings presented in Appendix II. This report does not reflect any variations which may occur adjacent to or between the borings and soundings. The nature and extent of the variations between the borings may not become evident until during construction.

This study does not include an evaluation of the environmental (ecological or hazardous/toxic material related) condition of the site and subsurface.

This report has been prepared for the exclusive use of Tetra Tech in accordance with generally accepted geotechnical engineering practices for the purpose of the subject project. No other warranty, expressed or implied, is made.

We are pleased to be of assistance to you on this phase of the project. When we may be of further service to you or should you have any questions, please contact us.

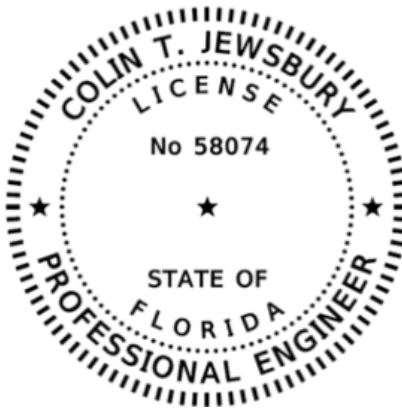
Very truly yours,
ARDAMAN & ASSOCIATES, INC.
Florida Registry 5950



Victor M. Steck, P.E.
Project Engineer
Florida License No. 90788



Colin T. Jewsbury, P.E.
Orlando Branch Manager
Florida License No. 58074



THIS ITEM HAS BEEN DIGITALLY
SIGNED AND SEALED BY:

ON THE DATE ADJACENT TO THIS SEAL.

PRINTED COPIES OF THIS DOCUMENT ARE
NOT CONSIDERED SIGNED AND SEALED
AND THIS SIGNATURE MUST BE VERIFIED
ON ANY ELECTRONIC COPIES.

ARDAMAN & ASSOCIATES, INC.
8008 S. ORANGE AVENUE
ORLANDO, FLORIDA 32809
(407) 855-3860
FLORIDA REGISTRY 5950
COLIN T. JEWSBURY, P.E. NO 58074

VMS/CTJ/lms/bls

23-60-6363 REV Tetra Tech - Lake Okeechobee Component A Restoration (LOCAR) Highlands County - 02-20-24.docx (Geo 2022)

CC: J-Tech

TABLE OF CONTENTS

<u>Chapter</u>	<u>Title</u>	<u>Page</u>
1.0	SITE LOCATION AND DESCRIPTION	1
2.0	REVIEW OF AVAILABLE DATA	1
	2.1 USGS Quadrangle Map	1
	2.2 Potentiometric Map	1
	2.3 Regional Physiography and Geology	1
3.0	FIELD EXPLORATION PROGRAM	3
	3.1 SPT Borings	3
	3.2 Undisturbed Tube Sampling	3
	3.3 Cone Penetration Test Soundings and Dissipation Tests	3
	3.4 Piezometer Installation and Slug Tests	4
	3.5 Double-Ring Infiltrometer (DRI) Tests	5
	3.6 Test Locations	5
4.0	LABORATORY PROGRAM	5
	4.1 Visual Examination and Classification Testing	5
	4.2 Standard Proctor Testing	6
	4.3 Consolidation Testing	6
	4.4 Triaxial Compression Strength Testing	6
	4.5 Hydraulic Conductivity Testing	7
5.0	GENERAL SUBSURFACE CONDITIONS	7
	5.1 General Soil Profile	7
	5.2 Groundwater Level	8
6.0	NORMAL SEASONAL HIGH GROUNDWATER LEVEL	8

TABLE OF CONTENTS
(Continued)

List of Tables

1	Summary of Laboratory Classification Test Results
2	Summary of Piezometer Construction and Slug Test Results
2A	Summary of Groundwater Levels in Piezometers
3	Summary of DRI Test Results
4	Summary of Laboratory Permeability Results

List of Figures

1	Boring Location Map
2 - 6	Fence Diagrams

Appendices

I	Standard Penetration Test and CPT Procedures
II	Soil Boring Logs, CPT Sounding Profiles, and CPT Dissipation Test Results
III	Slug Test Water Level Versus Time Curves
IV	Grain Size Distribution Curves
V	DRI Test Results
VI	Soil Sample Photo Log
VII	Standard Proctor, Consolidation, and Triaxial Laboratory Test Results
VIII	Hydraulic Conductivity Test Report Information and Photographs

1.0 SITE LOCATION AND DESCRIPTION

The site for the proposed reservoir is located on the Lykes Ranch Property, in the southeast portion of Highlands County, Florida. The general site vicinity map is shown on Figure 1.

The southern portion of the site currently consists of open, grassed pastureland with multiple bermed retention areas and wooded areas. The northern portion of the site currently consists of farmland containing row crops and multiple limerock paved roads. The site is bordered to the south by Canal C-41A, which runs between Lake Istokpoga, and Lake Okeechobee.

2.0 REVIEW OF AVAILABLE DATA

2.1 USGS Quadrangle Map

Based on review of the Highlands County, Florida, USGS quadrangle map, the natural ground surface elevation of the subject ranges between approximately +25 and +50 feet based on the 1929 National Geodetic Vertical Datum (NGVD). More specifically, the northern portion of the site ranges between approximately +40 and +50 feet NGVD while the southern portion ranges from approximately +25 to +40 feet NGVD. The presence of multiple “flowing wells” are denoted on the quadrangle map within the southern portion of the site.

2.2 Potentiometric Map

Based on review of the “Potentiometric Surface of the Upper Floridan Aquifer in the St. Johns River Water Management District and Vicinity” map published by the United States Geological Survey dated May 2009, the potentiometric surface elevation of the Upper Floridan aquifer in the vicinity of the site is approximately +35 to +45 feet NGVD.

2.3 Regional Physiography and Geology

According to the Hydrogeology and Groundwater Quality of Highlands County, Florida, as produced by the U.S. Geological Survey (2010), the site is located mainly within the Okeechobee Plain physiographic region of Highlands County. The Okeechobee Plain generally consists of level, well-drained land containing scattered ponds and marshes, and ranges in elevation from about +20 to +50 feet NGVD and generally slopes downward from north to south.

The stratigraphic sequence within the upper approximate 1,000 feet of deposits in this area of Highlands County consists of, in descending order: undifferentiated surficial deposits, the Hawthorn Group, the Suwannee Limestone, the Ocala Limestone, and the Avon Park Formation. The approximate elevations at which these geologic units can be encountered at the site are presented in the following table:

Estimated Elevation (Feet, NGVD 29)		Age	Stratigraphic Unit
From	To		
+50 to +30	-100 to -200	Pliocene/ Holocene	Undifferentiated surficial deposits
-100 to -200	-400 to -500	Miocene	Hawthorn Group
-400 to -500	-450 to -600	Oligocene	Suwannee Limestone
-450 to -600	-800 to -900	Late Eocene	Ocala Limestone
-800 to -900	< -2,000	Middle Eocene	Avon Park Formation

The Pliocene/Holocene undifferentiated surficial deposits in this area are primarily composed of varying amounts of sand, clay, and shell. The upper portion of this unit generally consists of unconsolidated fine to medium-grained quartz-sand while the lower portion consists of sand with varying amounts of shell and alternating clay layers. These sediments range from about 0 to 100 feet in thickness and overlie the Hawthorn Group. All of the geologic units exposed at the ground surface in the subject area are composed of these sediments from the Pliocene and Holocene age.

The Miocene Hawthorn Group consists of two formations; the Peace River Formation and the Arcadia Formation. The Peace River Formation consists of interbedded quartz sand, clay, and carbonates with variable amounts of phosphate. This formation ranges from about 60 to 120 feet in thickness and unconformably overlies the Arcadia formation.

The Arcadia Formation is composed of limestone and dolostone with varying amounts of quartz sand, clay, and phosphate. This unit ranges from about 150 to 450 feet in thickness and unconformably overlies the Suwannee Limestone or Ocala Limestone.

The Oligocene Suwannee Limestone underlies the Hawthorn Group in the western portion of the county. This formation generally does not exist in the eastern portion of the county and is likely not present over much of the subject site, however the exact limits are unknown. The Suwannee Limestone consists primarily of cream to white, soft, chalky, slightly porous limestone to slightly crystalline limestone. The Suwannee Limestone rests unconformably on the Ocala Limestone and has a maximum thickness of about 150 feet.

The late Eocene Ocala Limestone consists primarily of a white to tan, chalky, soft, poorly consolidated, fossiliferous, carbonate mud-rich limestone. Generally, the formation is very soft and crumbly, however can also be very well cemented. Thin dolostone beds can be present

toward the base. The Ocala Limestone rests unconformably on the Avon Park Formation and has a relatively uniform thickness of about 300 to 400 feet.

The middle Eocene Avon Park Formation consists primarily of beds of gray to brown limestone and dolomitic limestone, ranging from soft to hard and granular to chalky. The formation generally contains a highly fractured zone which is highly transmissive and produces some of the highest volumes of water from the upper Floridan aquifer. This formation ranges between 1,200 and 1,400 feet in thickness.

3.0 FIELD EXPLORATION PROGRAM

3.1 SPT Borings

The initial phase of field exploration program included performing 17 Standard Penetration Test (SPT) borings and the second phase included performing 14 SPT borings. The SPT borings were advanced to depths ranging from 40 to 150 feet below the existing ground surface generally using the methodology outlined in ASTM D-1586. A summary of this field procedure is included in Appendix I.

Soil samples recovered during performance of the borings were visually classified and photographed in the field and representative portions of the samples were transported to our laboratory in sealed sample jars.

The groundwater level at each of the boring locations was measured during drilling and again after a minimum period of approximately 24 hours. The borings were backfilled with cement grout upon completion.

3.2 Undisturbed Tube Sampling

Relatively undisturbed tube samples of clayey sand to clay encountered in SPT Borings designated B-02, B-05, B-06, B-23 and PZ-06 were obtained for laboratory consolidation testing, triaxial strength testing and permeability testing. The samples were retrieved using 3-inch diameter, thin-walled Shelby tubes. The samples were sealed in the Shelby tubes and transferred to our laboratory for classification and testing.

3.3 Cone Penetration Test Soundings and Dissipation Tests

Cone penetration test (CPT) soundings were performed to depths ranging from 22 to 75 feet below the existing ground surface generally using the methodology outlined in ASTM D-5778. The purpose of the CPT soundings was to evaluate the variability in the stratigraphy and properties of the in-situ soils, and to identify trends in strength versus depth. Plots of the measured penetration tip resistance, pore pressure, sleeve friction and friction ratio versus depth

for each sounding are presented in Appendix II. A summary of the CPT field procedure is included in Appendix I.

Pore water pressure dissipation tests were conducted at select depths at each of the sounding locations. The purpose of the dissipation tests was to measure the rate of decay of excess pore pressure generated by the advancement of the cone tool. We note that it can take many hours or even days for excess pore pressures to fully dissipate in fine grained soils, thereby allowing measurement of ambient water pressure. Most of the dissipation tests conducted as part of this study were only conducted for periods of time up to approximately 25 minutes and did not measure fully dissipated pore water pressures. Plots of the pore pressure versus time for each dissipation test are included in Appendix II.

We note that cone soundings and dissipation tests other than for CPT-06 and CPT-03A were performed by Insitu Group. The estimated permeability values presented on their dissipation test data sheets included in Appendix II were calculated based on published correlations and proprietary software developed by Insitu Group. These correlations are broad, and as such, the stated soil permeability values are subject to much uncertainty and should be used as a rough guide only. Ardaman & Associates do not warranty to accuracy and/or validity of the correlations provided by others.

We note that the interpolated soil types, estimated equivalent SPT N-Values included in Appendix II are also based on published correlations and should also be considered rough approximations only.

Permeability data obtained by field slug testing and laboratory testing of recovered soil samples should be considered much more reliable than interpretation of CPT dissipation tests.

3.4 Piezometer Installation and Slug Tests

The 2-inch temporary piezometers were installed using mud rotary drilling with a 6-inch diameter cutting bit and screened in 5 to 10 foot increments between depths of approximately 10 to 70 feet below existing ground surface. The annulus surrounding the piezometers was filled with a Size 20/30 sand pack from a depth of approximately 1 foot below the bottom of the screen to 1 foot above the top of screen. The sand pack was capped with approximately 2 feet of bentonite and the remaining borehole backfilled with cement grout. After the grout had been allowed to cure, the piezometers were developed until produced water was relatively free of contaminants.

Slug tests were performed on the piezometers using solid slugs. Slug test data for both falling head and rising head tests were analyzed using the Hvorslev method to calculate the hydraulic conductivity for each location. The summary of piezometer construction and slug test results are

presented in Table 2 of this report. In addition, plotted values of water level versus time recorded in each test are included in Appendix III.

Groundwater levels measured in the piezometers are presented in Table 2A of this report.

3.5 Double-Ring Infiltrometer (DRI) Tests

The double-ring infiltrometer (DRI) tests were conducted at selected locations across the site. The DRI tests were conducted in general accordance with ASTM D-3385 procedure, "Infiltration Rate of Soils in Field Using Double-Ring Infiltrometer".

Prior to running each test, an excavation was made to a depth of 6 inches below the ground surface at the test location. The DRI test consisted of driving two open cylinders, one inside the other, into the ground at the test location. Both rings were seated approximately 6 inches below the bottom of the excavation. The rings were partially filled with water until a constant water level was achieved. A measurement of time versus water volumes added to the inner ring to maintain a constant water level was then recorded while the water level in the outer ring was maintained at a constant level during the duration of the test. The DRI test results are summarized in Table 3 and detailed results are presented in Appendix V.

3.6 Test Locations

The approximate locations of the borings, soundings, and DRI tests are schematically illustrated on a boring location map shown on Figure 1. These locations were determined in the field by Global Positioning System (GPS) utilizing hand-held GPS equipment and coordinates obtained from Google Earth Pro. Elevations of the test locations were provided by the client based on readily available LIDAR data. Testing locations and elevations should be considered accurate only to the degree implied by the method of locating used. The slug tests were conducted in piezometer casings installed in or adjacent to Borings PZ-01 through PZ-06.

4.0 LABORATORY PROGRAM

4.1 Visual Examination and Classification Testing

Representative soil samples obtained during our field sampling operation were packaged and transferred to our laboratory for further visual examination and classification. The soil samples were classified using visual-manual procedures in general accordance with the Unified Soil Classification System (ASTM D-2488). The resulting soil descriptions are shown on the soil boring profiles presented in Appendix II. A photo log of the recovered samples is included in Appendix VI.

In addition, we conducted 4 organic content test (ASTM D-2974-87), 39 natural moisture content tests (ASTM D-2216), 14 grain size analyses (ASTM D-6913), 107 percent fines analyses (ASTM D-1140), and 32 Atterberg limits tests (ASTM D-4318) on selected soil samples obtained from the borings. The results of these tests are summarized in Table 1 and presented adjacent to the sample depth on the boring profiles in Appendix II. Grain size distribution curves are also included in Appendix IV.

4.2 Standard Proctor Testing

A grab-sample obtained from a location adjacent to Boring B-07 was selected for laboratory proctor testing to provide information on the optimum moisture content and maximum dry density of the soil. The testing was conducted in general accordance with ASTM Standard D698. The resulting dry density versus moisture content curve is presented in Appendix VII.

4.3 Consolidation Testing

Sub-samples of soil taken from the Shelby tube samples obtained from Borings B-02, B-05, B-06 and B-23 were selected for laboratory consolidation testing. This testing is designed to provide information on the compressibility of the soil. The resulting void ratio versus log pressure curve of each test are included in Appendix VII.

4.4 Triaxial Compression Strength Testing

A Laboratory Unconsolidated Undrained (UU-type) triaxial compression test was performed on a sub-sample of clayey soil selected from a Shelby tube sample obtained from Boring B-02. An additional UU-type triaxial compression test was performed on a grab sample of sandy soil obtained at the location of Boring B-07 and remolded to 95% of its maximum dry value. The triaxial compression tests were conducted in general accordance with ASTM Standard D2850 using a constant rate of strain of approximately 1% per minute.

Sample I.D.	Description	Percent Fines	Depth	Results at ($\sigma_1 - \sigma_3$) max	
			(ft)	Compressive Strength (kg/cm ²)	Strain (%)
B-02	Silty Fine Sand (SM)	26.4	61.5 - 62	1.329	11
B-07	Fine Sand with Silt (SP-SM)	9.1	1 - 3	1.702	7.9

*Testing performed in general accordance with ASTM D2850

Please refer to Appendix VII for additional details relative to the laboratory triaxial tests.

4.5 Hydraulic Conductivity Testing

Sub-samples of soil taken from the Shelby tube samples obtained from Borings B-02 and B-05 were selected for constant head laboratory hydraulic conductivity testing. Testing was conducted in general accordance with ASTM Standard D5084, Method A. The results of the laboratory hydraulic conductivity tests are summarized in Table 4. More detailed test report information, in addition to photographs of the tested soil samples, are included in Appendix VIII.

5.0 GENERAL SUBSURFACE CONDITIONS

5.1 General Soil Profile

The results of the field exploration and laboratory programs are graphically summarized on the soil boring and sounding profiles presented in Appendix II. The stratification of the boring and sounding profiles represents our interpretation of the logs and the results of laboratory examinations of the recovered samples. The stratification lines represent the approximate boundary between soil types. The actual transitions may be more gradual than implied.

The results of the borings and soundings indicate the following general soil profile:

Depth Below Ground Surface (feet)		Description
From	To	
0	27 – 47	Undifferentiated sandy sediments consisting of alternating layers of loose to dense sand (SP), sand with silt (SP-SM), silty sand (SM), sand with clay (SP-SC) and clayey sand (SC).
27 – 47	32 – 52	Very loose silty sand (SM) and clayey sand (SC) and very soft sandy clay to clay (CH/CL), with varying amounts of shell and phosphate. This very loose and very soft zone generally ranged from 5 to 15 feet in thickness and was differentiated from the upper sands by a distinct gray to green gray chroma.
32 – 52	102 – 117	Very loose to medium dense silty sand (SM), clayey sand (SC), and firm to stiff sandy clay to clay (CH/CL), with varying amounts of shell and phosphate.

Depth Below Ground Surface (feet)		Description
From	To	
102 – 117	150	Medium dense to very dense clayey sand (SC) and very stiff to hard sandy clay to clay (CH/CL) with varying amounts of shell and phosphate.

The above soil profile is outlined in general terms only. Please refer to Figures 2 through 6 and Appendix II for soil profile details. We note that the ordering of the boring logs as shown on fence log Figures 2 through 6 was requested by Jacobs.

5.2 Groundwater Level

The groundwater level was measured in the boreholes during drilling and again after a minimum period of approximately 24 hours. As shown on the Boring and Sounding logs in Appendix II, groundwater was encountered at depths that ranged from approximately 1½ to 6 feet below the existing ground surface on the dates indicated. Fluctuation in groundwater levels should be anticipated throughout the year primarily due to seasonal variations in rainfall and other factors that may vary from the time the borings were conducted.

Groundwater levels were also measured in each of the piezometers on multiple dates. A summary of the measured groundwater levels in the piezometers is presented in Table 2A.

We note that the results of a dissipation test conducted at a depth of approximately 59 feet in the Sounding designated CPT-07 indicate the presence of an elevated (i.e. artesian type) water pressure condition at that location.

6.0 NORMAL SEASONAL HIGH GROUNDWATER LEVEL

The groundwater level is affected by a number of factors. The amount of rainfall and the drainage characteristics of the soils, the land surface elevation, relief points such as drainage ditches, lakes, rivers, swamp areas, etc., and distance to relief points are some of the more important factors influencing the groundwater level.

The normal seasonal high groundwater level each year is the level in the August-September period at the end of the rainy season during a year of normal (average) rainfall. The water table elevations associated with a higher than normal rainfall and in the extreme case, flood, would be higher to much higher than the normal seasonal high groundwater level, and could occur at times outside of the August-September period. The normal high water levels would more approximate the normal seasonal high groundwater levels.

Based on our interpretation of the site conditions using our boring and sounding logs, we estimate the normal seasonal high groundwater level at the boring locations to be approximately 2 feet above the groundwater levels measured at the time of our May/June field exploration, and approximately 1 foot above the groundwater levels measured at the time of our August field exploration. Groundwater may perch temporarily at higher levels on top of the clayey and silty soil during periods of heavy and/or prolonged rainfall.

We note that the estimated normal seasonal high groundwater level is at or above the existing ground surface at some test locations. The height to which water may rise above the existing ground surface should be determined by a drainage engineer.



TABLE 1

Summary of Laboratory Classification Test Results
 Lake Okeechobee Component A Reservoir
 Highlands County, Florida

Boring I.D.	Sample No.	Depth (ft)	USCS Classification	Grain Size Distribution - Percent Passing						OC (%)	NM (%)	Atterberg Limits (%)	
				#10 (%)	#40 (%)	#60 (%)	#100 (%)	#140 (%)	#200 (%)			Liquid Limit	Plasticity Index
B-01	4	4.5 - 6	SP	--	--	--	--	--	4	--	--	--	--
	7	9 - 10.5	SP-SC	--	--	--	--	--	10	--	--	--	--
	9	18.5 - 20	SP-SC	--	--	--	--	--	8	--	--	--	--
	13	38.5 - 40	CH	--	--	--	--	--	52	--	51	86	50
	17	58.5 - 60	SC	--	--	--	--	--	33	--	--	--	--
	18	63.5 - 65	SC	--	--	--	--	--	40	--	37	46	20
	28	113.5 - 115	SC	--	--	--	--	--	33	--	--	--	--
	32	133.5 - 135	SP-SC	--	--	--	--	--	11	--	--	--	--
B-02	3	3 - 4.5	SP-SM	--	--	--	--	--	10	--	--	--	--
	8	11 - 12.5	SC	--	--	--	--	--	24	--	--	--	--
	11	16 - 17.5	SP	--	--	--	--	--	4	--	--	--	--
	14	26 - 27.5	SP-SM	--	--	--	--	--	7	--	--	--	--
	19	38.5 - 40	SC	--	--	--	--	--	15	--	--	--	--
	20	41 - 42.5	SP-SM	--	--	--	--	--	11	--	29	NP	NP
	SH-1	48 - 50	SC	99	99	97	92	52	35	--	34	39	18
	26	56 - 57.5	CH	--	--	--	--	--	85	--	--	--	--
	SH-2	57 - 57.5	CH	--	--	--	--	--	88	--	86	--	--
	SH-2	57.5 - 58	CH	--	--	--	--	--	79	--	82	101	80
	SH-3	61 - 61.5	SM	--	--	--	--	--	--	--	39	NP	NP
	SH-3	61.5 - 62	SM	100	94	93	88	42	26	--	29	--	--
	SH-3	62.5 - 63	SM	96	93	92	88	35	20	--	30	--	--
	35	78.5 - 80	SP-SC	--	--	--	--	--	7	--	--	--	--
40	91 - 92.5	SP-SC	--	--	--	--	--	6	--	--	--	--	

OC = Organic Content NM = Natural Moisture Content -- = Property Not Measured NP = Non Plastic

TABLE 1 (Continued)

Summary of Laboratory Classification Test Results
 Lake Okeechobee Component A Reservoir
 Highlands County, Florida

Boring I.D.	Sample No.	Depth (ft)	USCS Classification	Grain Size Distribution - Percent Passing						OC (%)	NM (%)	Atterberg Limits (%)	
				#10 (%)	#40 (%)	#60 (%)	#100 (%)	#140 (%)	#200 (%)			Liquid Limit	Plasticity Index
B-03	6	7.5 - 9	SP-SM	--	--	--	--	--	12	--	--	--	--
	7	9 - 10.5	SP-SM	--	--	--	--	--	10	--	--	--	--
	12	33.5 - 35	SP-SM	--	--	--	--	--	7	--	--	--	--
	18	63.5 - 65	SC	--	--	--	--	--	15	--	--	--	--
	20	73.5 - 75	SP-SM	--	--	--	--	--	12	--	7	NP	NP
B-04	7	9 - 10.5	SP-SM	--	--	--	--	--	11	--	--	--	--
	15	48.5 - 50	SC	--	--	--	--	--	13	--	--	--	--
	19	68.5 - 70	SM	--	--	--	--	--	18	--	33	NP	NP
B-05	3	3 - 4.5	SM	--	--	--	--	--	16	4	22	--	--
	8	10.5 - 12	SP	--	--	--	--	--	4	--	--	--	--
	13	18 - 20	SP-SM	--	--	--	--	--	6	--	--	--	--
	22	41 - 42.5	SP-SC	--	--	--	--	--	8	--	--	--	--
	SH-25	48 - 50	CH	--	--	--	--	--	59	--	45	55	35
	27	53.5 - 55	SC	--	--	--	--	--	32	--	--	--	--
	SH-29	58 - 60	SC	--	--	--	--	--	28	--	43	48	26
	35	73.5 - 75	SC	55	34	32	25	20	17	--	29	--	--
38	88.5 - 90	CH	--	--	--	--	--	51	--	--	--	--	
B-06	8	13.5 - 15	SP-SM	--	--	--	--	--	11	--	--	--	--
	11	28.5 - 30	SP-SM	100	76	36	20	15	9	--	--	--	--
	14	43.5 - 45	CL	--	--	--	--	--	67	--	61	--	--
	SH-16	52 - 54	SC	--	--	--	--	--	40	--	31	33	18
	19	73.5 - 75	SC	--	--	--	--	--	37	--	28	41	17
	21	78.5 - 80	SC	--	--	--	--	--	45	--	--	--	--

OC = Organic Content NM = Natural Moisture Content -- = Property Not Measured NP = Non Plastic

TABLE 1 (Continued)

Summary of Laboratory Classification Test Results
 Lake Okeechobee Component A Reservoir
 Highlands County, Florida

Boring I.D.	Sample No.	Depth (ft)	USCS Classification	Grain Size Distribution - Percent Passing						OC (%)	NM (%)	Atterberg Limits (%)	
				#10 (%)	#40 (%)	#60 (%)	#100 (%)	#140 (%)	#200 (%)			Liquid Limit	Plasticity Index
B-07	3	3 - 4.5	SP-SM	--	--	--	--	--	11	--	--	--	--
	11	28.5 - 30	SP	--	--	--	--	--	4	--	--	--	--
	20	73.5 - 75	SC	--	--	--	--	--	44	--	34	43	22
	S-1	1 - 3	SP-SM	--	--	--	--	--	9	--	--	--	--
B-08	8	13.5 - 15	SM	--	--	--	--	--	13	--	--	--	--
	10	23.5 - 25	SP-SM	--	--	--	--	--	6	--	--	--	--
	17	58.5 - 60	SC	--	--	--	--	--	33	--	33	40	22
	22	83.5 - 85	SC	--	--	--	--	--	24	--	31	35	12
B-13	4	4.5 - 6	SP-SM	--	--	--	--	--	7	--	--	--	--
	6	7.5 - 9	SC	--	--	--	--	--	18	--	--	--	--
	11	28.5 - 30	SC	--	--	--	--	--	13	--	28	32	10
	13	38.5 - 40	SP-SC	--	--	--	--	--	6	--	--	--	--
B-14	4	4.5 - 6	SP	100	98	97	63	26	4	--	--	--	--
	8	13.5 - 15	SC	--	--	--	--	--	16	--	--	--	--
B-15	5	6 - 7.5	SC	--	--	--	--	--	24	--	--	--	--
	13	38.5 - 40	CH	--	--	--	--	--	79	--	57	86	61
B-16	2	1.5 - 3	SP-SM	100	98	92	74	30	7	--	--	--	--
	7	9 - 10.5	SC	--	--	--	--	--	18	--	--	--	--
	12	33.5 - 35	SP-SC	--	--	--	--	--	8	--	36	NP	NP
B-17	3	3 - 4.5	CH	--	--	--	--	--	54	1	30	--	--
	8	13.5 - 15	SP	--	--	--	--	--	2	--	--	--	--
	12	33.5 - 35	SP-SC	--	--	--	--	--	6	--	--	--	--

OC = Organic Content NM = Natural Moisture Content -- = Property Not Measured NP = Non Plastic

TABLE 1 (Continued)

Summary of Laboratory Classification Test Results
 Lake Okeechobee Component A Reservoir
 Highlands County, Florida

Boring I.D.	Sample No.	Depth (ft)	USCS Classification	Grain Size Distribution - Percent Passing						OC (%)	NM (%)	Atterberg Limits (%)	
				#10 (%)	#40 (%)	#60 (%)	#100 (%)	#140 (%)	#200 (%)			Liquid Limit	Plasticity Index
B-18	3	3 - 4.5	SP-SC	100	99	99	77	38	9	--	--	--	--
	8	13.5 - 15	SP-SM	--	--	--	--	--	8	--	--	--	--
	10	23.5 - 25	SP-SC	--	--	--	--	--	6	--	--	--	--
	14	43.5 - 45	SM	--	--	--	--	--	21	--	30	NP	NP
	19	68.5 - 70	SC	--	--	--	--	--	28	--	--	--	--
	21	78.5 - 80	SC	--	--	--	--	--	23	--	38	44	18
B-19	7	9 - 10.5	SC	--	--	--	--	--	36	2	28	--	--
	9	18.5 - 20	SP-SC	--	--	--	--	--	5	--	--	--	--
	13	38.5 - 40	SP	--	--	--	--	--	3	--	--	--	--
	16	53.5 - 55	SC	--	--	--	--	--	15	--	--	--	--
	20	73.5 - 75	SC	--	--	--	--	--	40	--	60	41	22
B-20	1	0 - 1.5	SP-SM	100	100	99	85	44	9	--	--	--	--
	10	23.5 - 25	SP-SC	--	--	--	--	--	6	--	--	--	--
	16	53.5 - 55	SC	--	--	--	--	--	21	--	--	--	--
	20	73.5 - 75	SC	--	--	--	--	--	19	--	--	--	--
B-21	3	3 - 4.5	SP-SM	100	99	94	80	32	6	--	--	--	--
	9	18.5 - 20	SP-SC	--	--	--	--	--	10	--	--	--	--
	10	23.5 - 25	SM	--	--	--	--	--	18	--	18	NP	NP
B-22	4	4.5 - 6	SC	--	--	--	--	--	14	--	--	--	--
	8	13.5 - 15	SM	--	--	--	--	--	16	--	--	--	--
	11	28.5 - 30	CH	--	--	--	--	--	56	--	--	--	--
	13	38.5 - 40	SC	--	--	--	--	--	30	--	57	63	38

OC = Organic Content NM = Natural Moisture Content -- = Property Not Measured NP = Non Plastic

TABLE 1 (Continued)

Summary of Laboratory Classification Test Results
 Lake Okeechobee Component A Reservoir
 Highlands County, Florida

Boring I.D.	Sample No.	Depth (ft)	USCS Classification	Grain Size Distribution - Percent Passing						OC (%)	NM (%)	Atterberg Limits (%)	
				#10 (%)	#40 (%)	#60 (%)	#100 (%)	#140 (%)	#200 (%)			Liquid Limit	Plasticity Index
B-23	2	1.5 - 3	SP-SM	--	--	--	--	--	6	--	--	--	--
	10	23.5 - 25	SP-SC	--	--	--	--	--	7	--	--	--	--
	14	43.5 - 45	SP	--	--	--	--	--	4	--	--	--	--
	17	58.5 - 60	CH	--	--	--	--	--	55	--	--	--	--
	SH-1	60 - 62	CH	--	--	--	--	--	71	--	56	89	53
B-24	4	4.5 - 6	SP-SM	--	--	--	--	--	7	4	33	--	--
	8	13.5 - 15	SM	--	--	--	--	--	13	--	--	--	--
	11	28.5 - 30	SC	--	--	--	--	--	16	--	--	--	--
	13	38.5 - 40	CH	--	--	--	--	--	58	--	70	88	65
B-25	1	0 - 1.5	SP-SC	100	99	93	76	37	8	--	--	--	--
	9	18.5 - 20	SM	--	--	--	--	--	14	--	--	--	--
	11	28.5 - 30	SP-SC	--	--	--	--	--	7	--	--	--	--
PZ-01	9	18.5 - 20	SP-SM	100	90	50	15	10	8	--	--	--	--
	11	28.5 - 30	SC	--	--	--	--	--	18	--	31	35	15
	18	63.5 - 65	SM	--	--	--	--	--	20	--	29	NP	NP
PZ-02	2	1.5 - 3	SP-SM	100	99	96	84	42	9	--	--	--	--
	9	18.5 - 20	SP-SM	--	--	--	--	--	5	--	--	--	--
	12	33.5 - 35	CH	--	--	--	--	--	93	--	71	108	78
	15	48.5 - 50	SC	--	--	--	--	--	32	--	--	--	--
PZ-03	5	6 - 7.5	SC	--	--	--	--	--	20	--	--	--	--
	10	23.5 - 25	SP-SM	--	--	--	--	--	11	--	--	--	--
	14	43.5 - 45	SM	--	--	--	--	--	34	--	--	--	--
	15	48.5 - 50	SC	--	--	--	--	--	30	--	--	--	--

OC = Organic Content NM = Natural Moisture Content -- = Property Not Measured NP = Non Plastic

TABLE 1 (Continued)

Summary of Laboratory Classification Test Results
 Lake Okeechobee Component A Reservoir
 Highlands County, Florida

Boring I.D.	Sample No.	Depth (ft)	USCS Classification	Grain Size Distribution - Percent Passing						OC (%)	NM (%)	Atterberg Limits (%)	
				#10 (%)	#40 (%)	#60 (%)	#100 (%)	#140 (%)	#200 (%)			Liquid Limit	Plasticity Index
PZ-04	9	18.5 - 20	SP-SM	--	--	--	--	--	7	--	--	--	--
	14	43.5 - 45	SC	--	--	--	--	--	46	--	--	--	--
PZ-05	8	13.5 - 15	SP-SC	--	--	--	--	--	10	--	--	--	--
	9	18.5 - 20	SP-SC	--	--	--	--	--	8	--	--	--	--
	15	48.5 - 50	SC	--	--	--	--	--	22	--	--	--	--
PZ-06	3	3 - 4.5	SP-SM	--	--	--	--	--	12	--	--	--	--
	8	13.5 - 15	SP	--	--	--	--	--	4	--	--	--	--
	SH-12	30 -32	SM	--	--	--	--	--	26	--	42	43	14
	13	38.5 - 40	SC	--	--	--	--	--	23	--	26	37	17

OC = Organic Content NM = Natural Moisture Content -- = Property Not Measured NP = Non Plastic

TABLE 2

Summary of Piezometer Construction and Slug Test Results
 Lake Okeechobee Component A Reservoir
 Highlands County, Florida

I.D.	Zone	Diameter (inches)	Stick-Up (ft)	Northing	Easting	Screen Depth		Screen Length (ft)	USCS Soil Type	Hydraulic Conductivity			
						Top	Bottom			Slug In (ft/day)	Slug Out (ft/day)	Slug In (cm/sec)	Slug Out (cm/sec)
PZ-01	Shallow	2	2.5	1,076,776	626,031	15.5	20.5	5	SP-SM	3.5	3.2	1.2 x 10 ⁻³	1.1 x 10 ⁻³
	Deep	2	2.5			59.5	69.5	10	CH/SM/SC	<0.1	<0.1	2.1 x 10 ⁻⁵	1.4 x 10 ⁻⁵
PZ-02	Shallow	2	0.70*	1,058,672	629,311	14.0	19.0	5	SP-SM	0.6	0.6	2.1 x 10 ⁻⁴	2.1 x 10 ⁻⁴
	Deep	2	0.66*			44.0	54.0	10	SM/SC	1.0	1.1	3.5 x 10 ⁻⁴	3.9 x 10 ⁻⁴
PZ-03	Shallow	2	0*	1,075,658	607,941	20.0	25.0	5	SP-SM	0.2	0.2	7.0 x 10 ⁻⁵	7.0 x 10 ⁻⁵
	Deep	2	3.0			45.0	55.0	10	SM/SC	10.1	7.9	3.5 x 10 ⁻³	2.8 x 10 ⁻³
PZ-04	Shallow	2	3.0	1,095,820	609,455	15.0	20.0	5	SP-SM	2.8	2.5	9.8 x 10 ⁻⁴	8.8 x 10 ⁻⁴
PZ-05	Shallow	2	3.0	1,110,676	600,398	15.0	20.0	5	SP-SC	2.7	2.9	9.5 x 10 ⁻⁴	1.0 x 10 ⁻³
	Deep	2	2.5			45.0	55.0	10	SC	2.1	2.4	7.5 x 10 ⁻⁴	8.4 x 10 ⁻⁴
PZ-06	Shallow	2	2.3	1,064,543	607,192	10.0	20.0	10	SP	1.9	1.4	6.8 x 10 ⁻⁴	5.0 x 10 ⁻⁴
	Deep	2	2.5			40.0	50.0	10	SC	1.3	1.3	4.4 x 10 ⁻⁴	4.5 x 10 ⁻⁴

* Piezometer stick-up broken after installation

TABLE 2A

Summary of Groundwater Levels in Piezometers
Lake Okeechobee Component A Reservoir
Highlands County, Florida

I.D/ Zone	Measurement Date/ Groundwater Depth (ft)		
PZ-01	5/30/2023	8/14/2023	8/28/2023
Shallow	6.47	1.16	2.33
Deep	10.76	5.10	5.50
PZ-02	5/30/2023	8/14/2023	8/28/2023
Shallow	6.82	0.72	2.63
Deep	6.41	0.88	1.59
PZ-03	6/12/2023	8/14/2023	8/28/2023
Shallow	6.50	1.16	1.58
Deep	5.23	2.16	2.58
PZ-04	6/13/2023	8/15/2023	8/28/2023
Shallow	5.09	2.16	3.00
PZ-05	6/13/2023	8/15/2023	8/28/2023
Shallow	5.93	2.12	3.00
Deep	6.84	2.33	--
PZ-06	--	--	8/28/2023
Shallow	--	--	1.95
Deep	--	--	0.41

TABLE 3

Summary of DRI Test Results
Lake Okeechobee Component A Reservoir
Highlands County, Florida

I.D.	Northing	Easting	Depth	Infiltration Rate*	
			(ft)	(in/hour)	(cm/sec)
DRI-01	1,066,440	626,569	0.5	7.8	5.5×10^{-3}
DRI-02	1,103,031	608,579	0.5	3.2	2.3×10^{-3}
DRI-03	1,065,732	610,700	0.5	12.9	9.2×10^{-3}

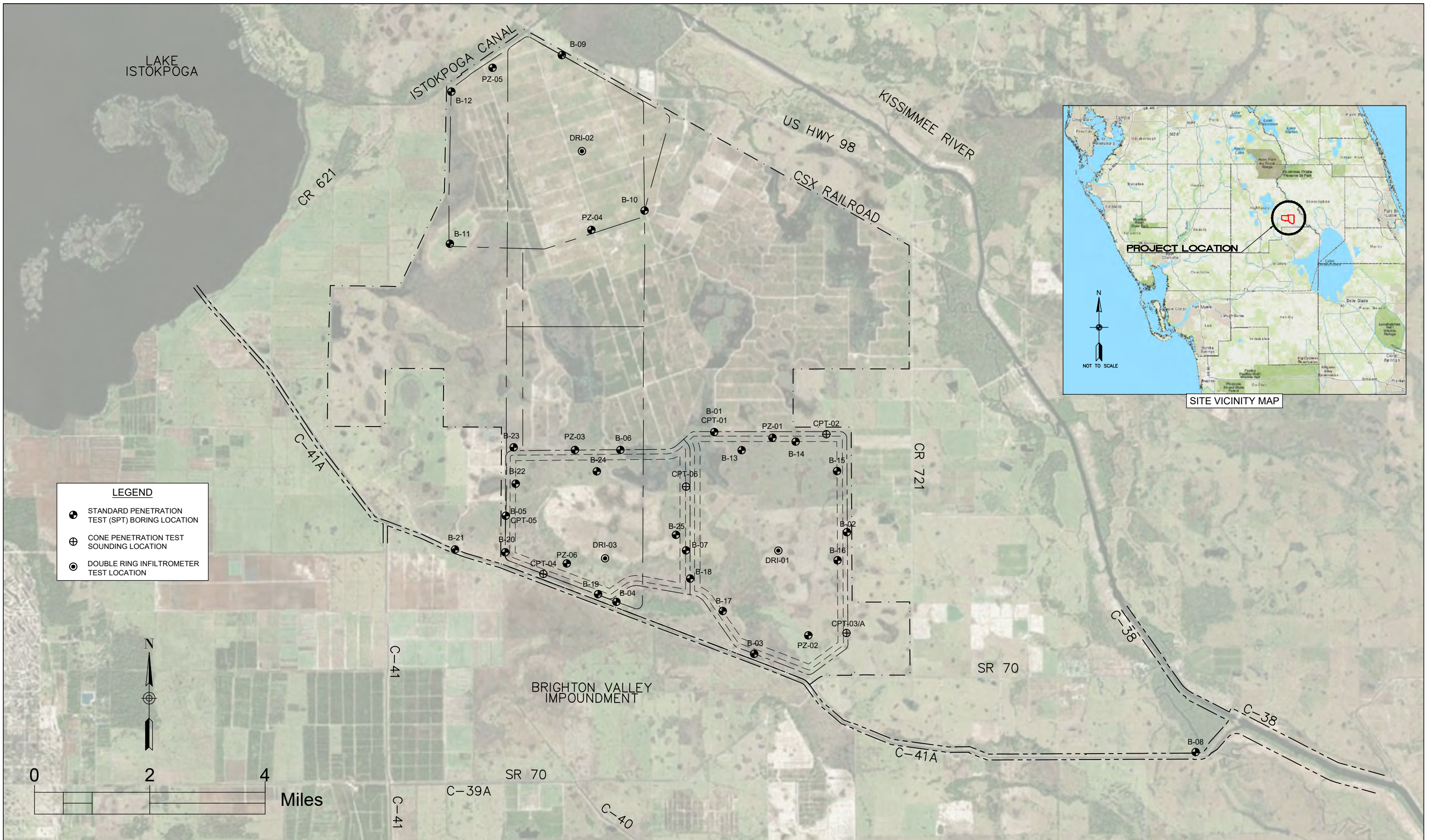
*Testing performed in general accordance with ASTM D3385

TABLE 4

Summary of Laboratory Permeability Results
Lake Okeechobee Component A Reservoir
Highlands County, Florida

Boring ID	Sample ID	Depth (ft)	Percent Fines of Sub-sample (%)	Measured Vertical Hydraulic Conductivity* (cm/sec)
B-02	S-1	48 – 50	35	5.1×10^{-6}
	S-2	57 – 57.5	88	1.4×10^{-7}
	S-3	62 – 62.5	20	1.1×10^{-5}
B-05	S-29	58 – 60	28	2.6×10^{-5}

*Testing performed in general accordance with ASTM 5084 Method A



**LAKE OKEECHOBEE COMPONENT A RESERVOIR (LOCAR)
BORING LOCATION MAP**

FIGURE 1
DATE: 9/20/2023



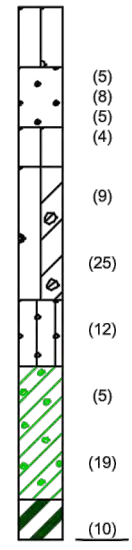
ELEVATIONS IN FEET N.A.V.D. 88



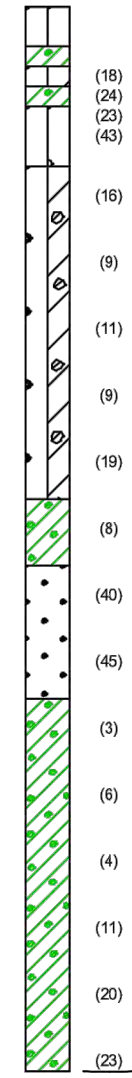
ELEVATIONS IN FEET N.A.V.D. 88



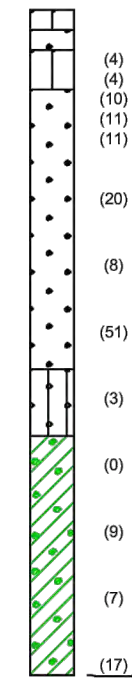
BOR. B-21
GROUND ELEV. 42.7



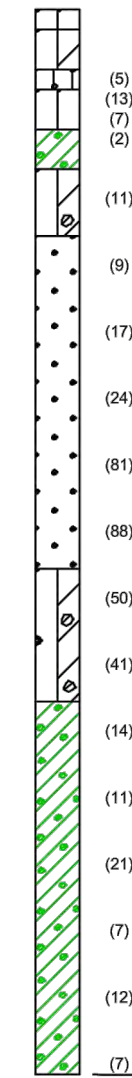
BOR. B-20
GROUND ELEV. 29.3



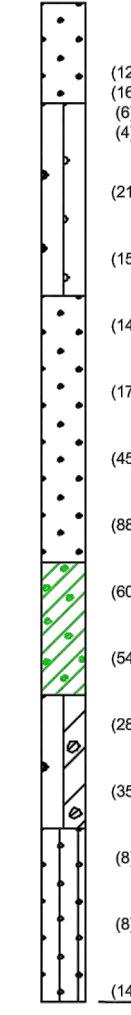
BOR. PZ-06
GROUND ELEV. 28.3



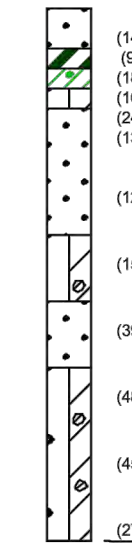
BOR. B-19
GROUND ELEV. 29.9



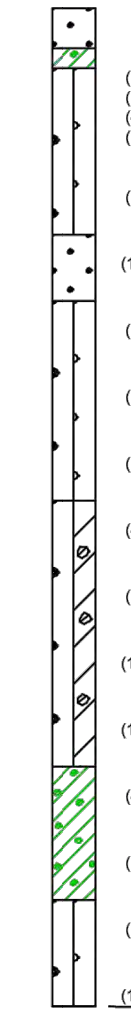
BOR. B-04
GROUND ELEV. 28.8



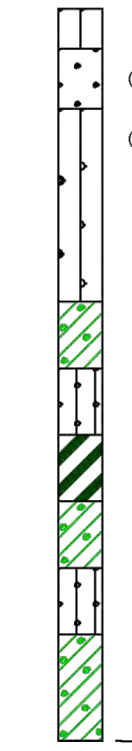
BOR. B-17
GROUND ELEV. 28.4



BOR. B-03
GROUND ELEV. 27.6



BOR. PZ-02
GROUND ELEV. 30.7



- SP - Sand, Poorly Graded
- SP-SM - Sand with Silt, Poorly Graded
- SP-SC - Sand with Clay, Poorly Graded
- SC - Clayey Sand
- CH - Fat Clay
- SM - Silty Sand
- CL - Lean Clay

SP,SP-SM UNIFIED SOIL CLASSIFICATION SYSTEM (ASTM D-2487)
SM,SC,CH

- NOTES:
- UPON COMPLETION OF EACH SPT BORING, THE BOREHOLE WAS GROUTED WITH CEMENT-BENTONITE SLURRY.
 - ALL SPT BORINGS WERE PERFORMED USING AN AUTOMATIC HAMMER TO THE BORING TERMINATION DEPTH. AUTOMATIC HAMMER N-VALUES MAY BE CONVERTED TO EQUIVALENT SAFETY HAMMER N-VALUES BY MULTIPLYING BY 1.24.
 - DIAGRAMS AUTOMATICALLY GENERATED USING US ARMY CORPS OF ENGINEERS STANDARD FENCE DRAWING TEMPLATE IN gINT COMPUTER PROGRAM.

GRANULAR MATERIALS- RELATIVE DENSITY	AUTOMATIC HAMMER SPT N-VALUE (BLOWS/FOOT)	SILTS AND CLAYS CONSISTENCY	AUTOMATIC HAMMER SPT N-VALUE (BLOWS/FOOT)
VERY LOOSE	LESS THAN 3	VERY SOFT	LESS THAN 1
LOOSE	3 TO 8	SOFT	1 TO 3
MEDIUM DENSE	8 TO 24	FIRM	3 TO 6
DENSE	24 TO 40	STIFF	6 TO 12
VERY DENSE	GREATER THAN 40	VERY STIFF	12 TO 24
		HARD	GREATER THAN 24

WHILE THE BORINGS ARE REPRESENTATIVE OF SUBSURFACE CONDITIONS AT THEIR RESPECTIVE LOCATIONS AND FOR THEIR RESPECTIVE VERTICAL REACHES, LOCAL VARIATIONS CHARACTERISTIC OF THE SUBSURFACE MATERIALS OF THE REGION ARE ANTICIPATED AND MAY BE ENCOUNTERED. THE BORING LOGS AND RELATED INFORMATION ARE BASED ON THE DRILLER'S LOGS AND VISUAL EXAMINATION OF SELECTED SAMPLES IN THE LABORATORY. THE DELINEATION BETWEEN SOIL TYPES SHOWN ON THE LOGS IS APPROXIMATE AND THE DESCRIPTION REPRESENTS OUR INTERPRETATION OF SUBSURFACE CONDITIONS AT THE DESIGNATED BORING LOCATIONS ON THE PARTICULAR DATE DRILLED.

FENCE DIAGRAMS

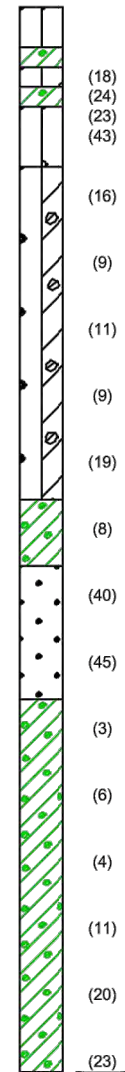
Ardaman & Associates, Inc.
Geotechnical, Environmental and
Materials Consultants

**SUBSURFACE SOIL EXPLORATION AND
GEOTECHNICAL ENGINEERING EVALUATION
LAKE OKEECHOBEE COMPONENT A RESTORATION
HIGHLANDS COUNTY, FLORIDA**

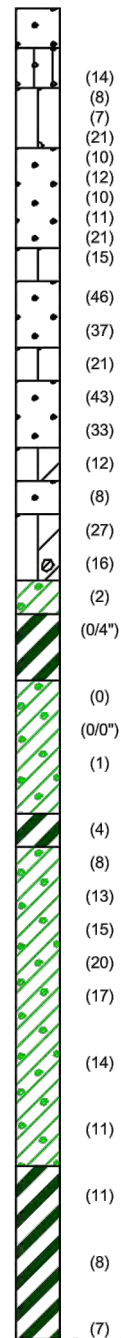
DRAWN BY: CD	DATE: 06/26/23
FILE NO. 23-6363	APPROVED BY: Colin T. Jewsbury, P.E.
	FIGURE: 2

ELEVATIONS IN FEET N.A.V.D. 88

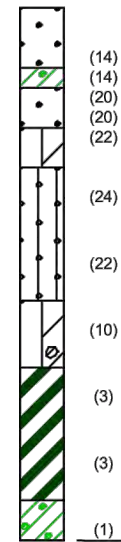
BOR. B-20
GROUND ELEV. 29.3



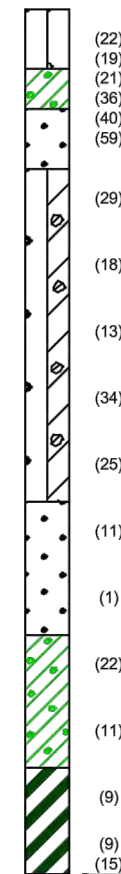
BOR. B-05
GROUND ELEV. 36.2



BOR. B-22
GROUND ELEV. 37.5



BOR. B-23
GROUND ELEV. 34.4



ELEVATIONS IN FEET N.A.V.D. 88

- SP - Sand, Poorly Graded
- SP-SM - Sand with Silt, Poorly Graded
- SP-SC - Sand with Clay, Poorly Graded
- SC - Clayey Sand
- CH - Fat Clay
- SM - Silty Sand
- CL - Lean Clay

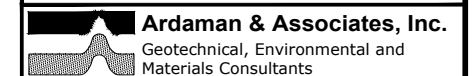
SP, SP-SM
SM, SC, CH
UNIFIED SOIL CLASSIFICATION SYSTEM (ASTM D-2487)

- NOTES:
- UPON COMPLETION OF EACH SPT BORING, THE BOREHOLE WAS GROUTED WITH CEMENT-BENTONITE SLURRY.
 - ALL SPT BORINGS WERE PERFORMED USING AN AUTOMATIC HAMMER TO THE BORING TERMINATION DEPTH. AUTOMATIC HAMMER N-VALUES MAY BE CONVERTED TO EQUIVALENT SAFETY HAMMER N-VALUES BY MULTIPLYING BY 1.24.
 - DIAGRAMS AUTOMATICALLY GENERATED USING US ARMY CORPS OF ENGINEERS STANDARD FENCE DRAWING TEMPLATE IN gINT COMPUTER PROGRAM.

GRANULAR MATERIALS- RELATIVE DENSITY	AUTOMATIC HAMMER SPT N-VALUE (BLOWS/FOOT)	SILTS AND CLAYS CONSISTENCY	AUTOMATIC HAMMER SPT N-VALUE (BLOWS/FOOT)
VERY LOOSE	LESS THAN 3	VERY SOFT	LESS THAN 1
LOOSE	3 TO 8	SOFT	1 TO 3
MEDIUM DENSE	8 TO 24	FIRM	3 TO 6
DENSE	24 TO 40	STIFF	6 TO 12
VERY DENSE	GREATER THAN 40	VERY STIFF	12 TO 24
		HARD	GREATER THAN 24

WHILE THE BORINGS ARE REPRESENTATIVE OF SUBSURFACE CONDITIONS AT THEIR RESPECTIVE LOCATIONS AND FOR THEIR RESPECTIVE VERTICAL REACHES, LOCAL VARIATIONS CHARACTERISTIC OF THE SUBSURFACE MATERIALS OF THE REGION ARE ANTICIPATED AND MAY BE ENCOUNTERED. THE BORING LOGS AND RELATED INFORMATION ARE BASED ON THE DRILLER'S LOGS AND VISUAL EXAMINATION OF SELECTED SAMPLES IN THE LABORATORY. THE DELINEATION BETWEEN SOIL TYPES SHOWN ON THE LOGS IS APPROXIMATE AND THE DESCRIPTION REPRESENTS OUR INTERPRETATION OF SUBSURFACE CONDITIONS AT THE DESIGNATED BORING LOCATIONS ON THE PARTICULAR DATE DRILLED.

FENCE DIAGRAMS



**SUBSURFACE SOIL EXPLORATION AND
GEOTECHNICAL ENGINEERING EVALUATION
LAKE OKEECHOBEE COMPONENT A RESTORATION
HIGHLANDS COUNTY, FLORIDA**

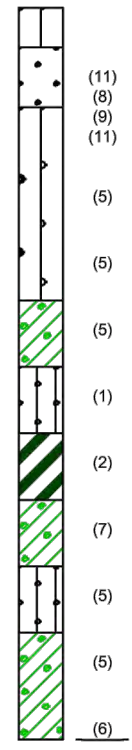
DRAWN BY: CD DATE: 06/26/23
FILE NO. 23-6363 APPROVED BY: Colin T. Jewsbury, P.E. FIGURE: 3

T:\Orlando\23\23-6363\23636304.dwg 10/19/2023 1:24:54 PM, Chris.Drew

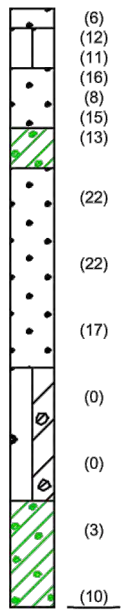
ELEVATIONS IN FEET N.A.V.D. 88



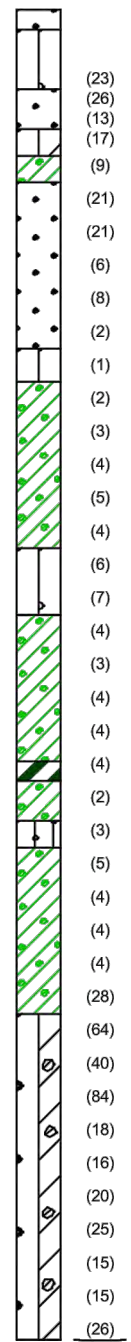
BOR. PZ-02
GROUND ELEV. 30.7



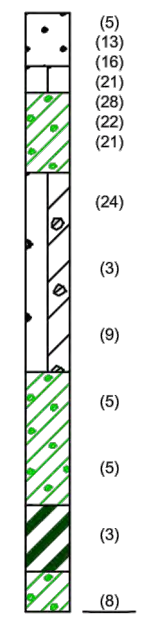
BOR. B-16
GROUND ELEV. 34.7



BOR. B-02
GROUND ELEV. 36.2



BOR. B-15
GROUND ELEV. 39.1



ELEVATIONS IN FEET N.A.V.D. 88



- SP - Sand, Poorly Graded
- SP-SM - Sand with Silt, Poorly Graded
- SP-SC - Sand with Clay, Poorly Graded
- SC - Clayey Sand
- CH - Fat Clay
- SM - Silty Sand
- CL - Lean Clay

- SP,SP-SM
SM,SC,CH
- UNIFIED SOIL CLASSIFICATION SYSTEM (ASTM D-2487)
- NOTES:
- UPON COMPLETION OF EACH SPT BORING, THE BOREHOLE WAS GROUTED WITH CEMENT-BENTONITE SLURRY.
 - ALL SPT BORINGS WERE PERFORMED USING AN AUTOMATIC HAMMER TO THE BORING TERMINATION DEPTH. AUTOMATIC HAMMER N-VALUES MAY BE CONVERTED TO EQUIVALENT SAFETY HAMMER N-VALUES BY MULTIPLYING BY 1.24.
 - DIAGRAMS AUTOMATICALLY GENERATED USING US ARMY CORPS OF ENGINEERS STANDARD FENCE DRAWING TEMPLATE IN gINT COMPUTER PROGRAM.

GRANULAR MATERIALS- RELATIVE DENSITY	AUTOMATIC HAMMER SPT N-VALUE (BLOWS/FOOT)	SILTS AND CLAYS CONSISTENCY	AUTOMATIC HAMMER SPT N-VALUE (BLOWS/FOOT)
VERY LOOSE	LESS THAN 3	VERY SOFT	LESS THAN 1
LOOSE	3 TO 8	SOFT	1 TO 3
MEDIUM DENSE	8 TO 24	FIRM	3 TO 6
DENSE	24 TO 40	STIFF	6 TO 12
VERY DENSE	GREATER THAN 40	VERY STIFF	12 TO 24
		HARD	GREATER THAN 24

WHILE THE BORINGS ARE REPRESENTATIVE OF SUBSURFACE CONDITIONS AT THEIR RESPECTIVE LOCATIONS AND FOR THEIR RESPECTIVE VERTICAL REACHES, LOCAL VARIATIONS CHARACTERISTIC OF THE SUBSURFACE MATERIALS OF THE REGION ARE ANTICIPATED AND MAY BE ENCOUNTERED. THE BORING LOGS AND RELATED INFORMATION ARE BASED ON THE DRILLER'S LOGS AND VISUAL EXAMINATION OF SELECTED SAMPLES IN THE LABORATORY. THE DELINEATION BETWEEN SOIL TYPES SHOWN ON THE LOGS IS APPROXIMATE AND THE DESCRIPTION REPRESENTS OUR INTERPRETATION OF SUBSURFACE CONDITIONS AT THE DESIGNATED BORING LOCATIONS ON THE PARTICULAR DATE DRILLED.

FENCE DIAGRAMS

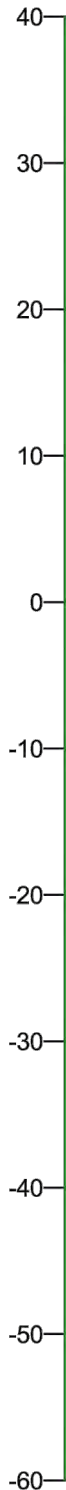
Ardaman & Associates, Inc.
Geotechnical, Environmental and
Materials Consultants

**SUBSURFACE SOIL EXPLORATION AND
GEOTECHNICAL ENGINEERING EVALUATION
LAKE OKEECHOBEE COMPONENT A RESTORATION
HIGHLANDS COUNTY, FLORIDA**

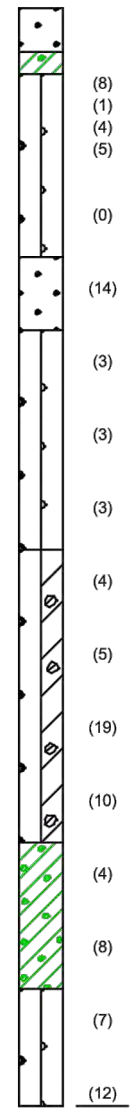
DRAWN BY: CD		DATE: 06/26/23
FILE NO. 23-6363	APPROVED BY: Colin T. Jewsbury, P.E.	FIGURE: 4

T:\Orlando\23\23-6363\23636304.dwg 10/19/2023 1:24:59 PM, Chris.Drew

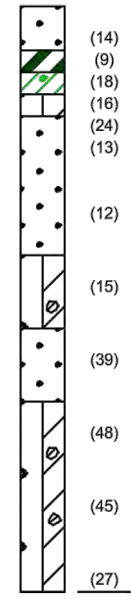
ELEVATIONS IN FEET N.A.V.D. 88



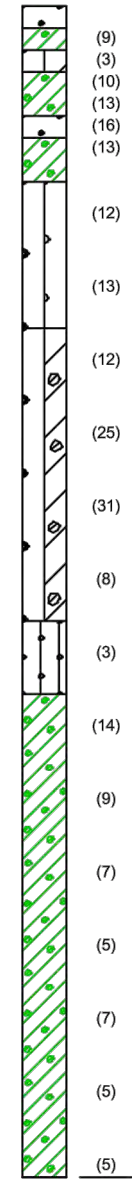
BOR. B-03
GROUND ELEV. 27.6



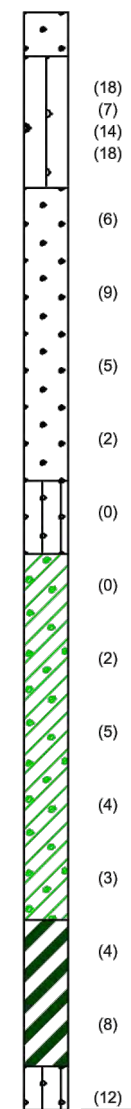
BOR. B-17
GROUND ELEV. 28.4



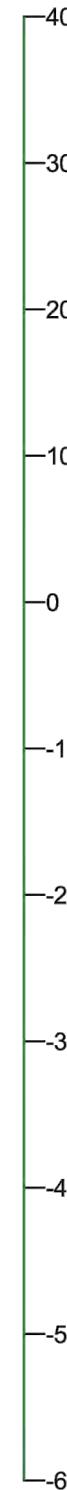
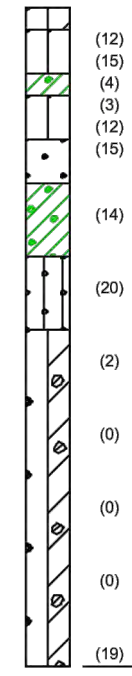
BOR. B-18
GROUND ELEV. 29.1



BOR. B-07
GROUND ELEV. 33.8



BOR. B-25
GROUND ELEV. 34.8



ELEVATIONS IN FEET N.A.V.D. 88

- SP - Sand, Poorly Graded
- SP-SM - Sand with Silt, Poorly Graded
- SP-SC - Sand with Clay, Poorly Graded
- SC - Clayey Sand
- CH - Fat Clay
- SM - Silty Sand
- CL - Lean Clay

- SP,SP-SM
SM,SC,CH
- UNIFIED SOIL CLASSIFICATION SYSTEM (ASTM D-2487)
- NOTES:
- UPON COMPLETION OF EACH SPT BORING, THE BOREHOLE WAS GROUTED WITH CEMENT-BENTONITE SLURRY.
 - ALL SPT BORINGS WERE PERFORMED USING AN AUTOMATIC HAMMER TO THE BORING TERMINATION DEPTH. AUTOMATIC HAMMER N-VALUES MAY BE CONVERTED TO EQUIVALENT SAFETY HAMMER N-VALUES BY MULTIPLYING BY 1.24.
 - DIAGRAMS AUTOMATICALLY GENERATED USING US ARMY CORPS OF ENGINEERS STANDARD FENCE DRAWING TEMPLATE IN gINT COMPUTER PROGRAM.

GRANULAR MATERIALS- RELATIVE DENSITY	AUTOMATIC HAMMER SPT N-VALUE (BLOWS/FOOT)	SILTS AND CLAYS CONSISTENCY	AUTOMATIC HAMMER SPT N-VALUE (BLOWS/FOOT)
VERY LOOSE	LESS THAN 3	VERY SOFT	LESS THAN 1
LOOSE	3 TO 8	SOFT	1 TO 3
MEDIUM DENSE	8 TO 24	FIRM	3 TO 6
DENSE	24 TO 40	STIFF	6 TO 12
VERY DENSE	GREATER THAN 40	VERY STIFF	12 TO 24
		HARD	GREATER THAN 24

WHILE THE BORINGS ARE REPRESENTATIVE OF SUBSURFACE CONDITIONS AT THEIR RESPECTIVE LOCATIONS AND FOR THEIR RESPECTIVE VERTICAL REACHES, LOCAL VARIATIONS CHARACTERISTIC OF THE SUBSURFACE MATERIALS OF THE REGION ARE ANTICIPATED AND MAY BE ENCOUNTERED. THE BORING LOGS AND RELATED INFORMATION ARE BASED ON THE DRILLER'S LOGS AND VISUAL EXAMINATION OF SELECTED SAMPLES IN THE LABORATORY. THE DELINEATION BETWEEN SOIL TYPES SHOWN ON THE LOGS IS APPROXIMATE AND THE DESCRIPTION REPRESENTS OUR INTERPRETATION OF SUBSURFACE CONDITIONS AT THE DESIGNATED BORING LOCATIONS ON THE PARTICULAR DATE DRILLED.

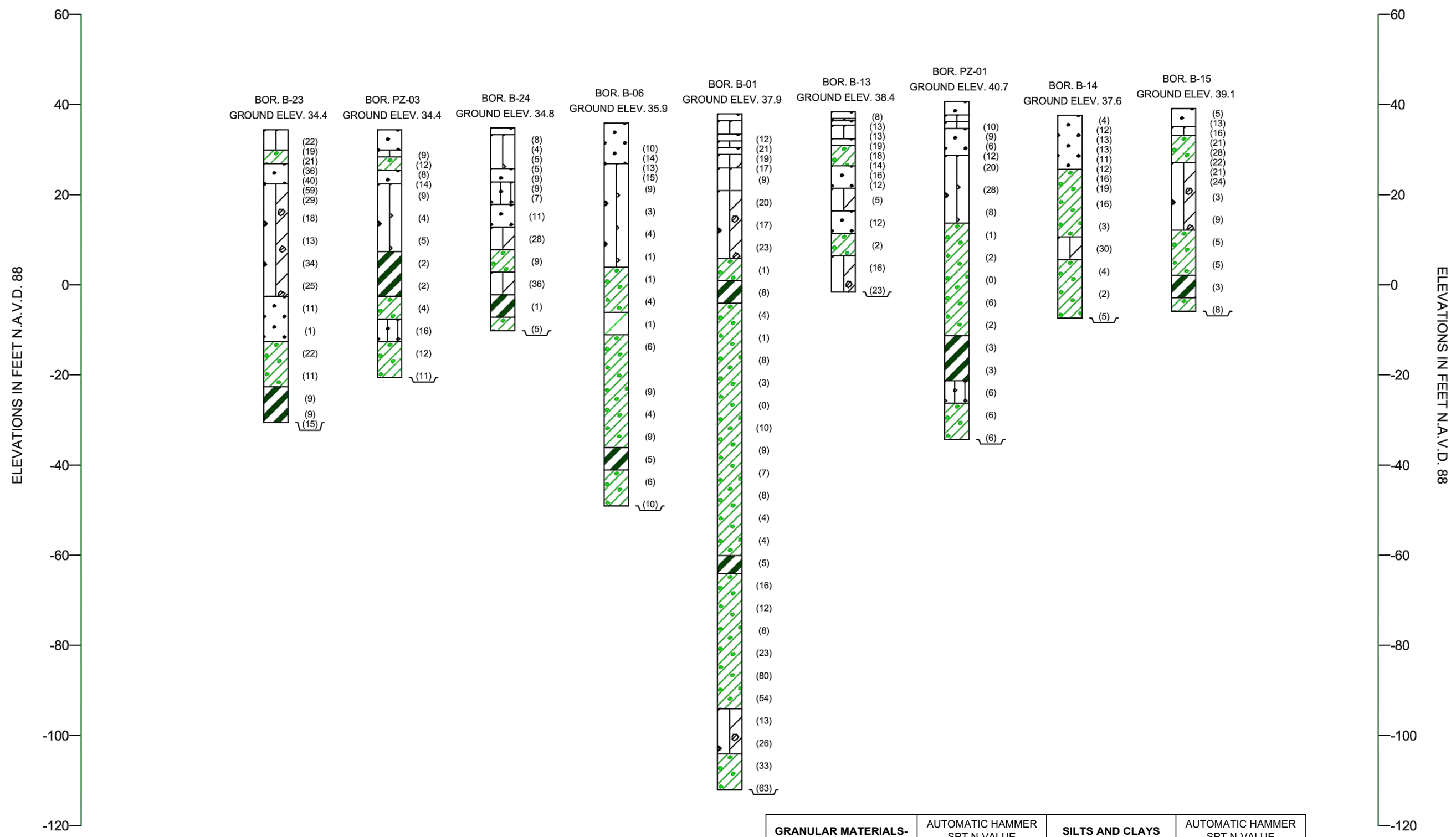
FENCE DIAGRAMS

Ardaman & Associates, Inc.
Geotechnical, Environmental and
Materials Consultants

**SUBSURFACE SOIL EXPLORATION AND
GEOTECHNICAL ENGINEERING EVALUATION
LAKE OKEECHOBEE COMPONENT A RESTORATION
HIGHLANDS COUNTY, FLORIDA**

DRAWN BY: CD	DATE: 06/26/23
FILE NO. 23-6363	APPROVED BY: Colin T. Jewsbury, P.E.
FIGURE: 5	

T:\Orlando\23\23-6363\23636304.dwg 10/19/2023 1:25:04 PM, Chris.Drew



- SP - Sand, Poorly Graded
- SP-SM - Sand with Silt, Poorly Graded
- SP-SC - Sand with Clay, Poorly Graded
- SC - Clayey Sand
- CH - Fat Clay
- SM - Silty Sand
- CL - Lean Clay

SP,SP-SM
SM,SC,CH
UNIFIED SOIL CLASSIFICATION SYSTEM (ASTM D-2487)

NOTES:

- UPON COMPLETION OF EACH SPT BORING, THE BOREHOLE WAS GROUTED WITH CEMENT-BENTONITE SLURRY.
- ALL SPT BORINGS WERE PERFORMED USING AN AUTOMATIC HAMMER TO THE BORING TERMINATION DEPTH. AUTOMATIC HAMMER N-VALUES MAY BE CONVERTED TO EQUIVALENT SAFETY HAMMER N-VALUES BY MULTIPLYING BY 1.24.
- DIAGRAMS AUTOMATICALLY GENERATED USING US ARMY CORPS OF ENGINEERS STANDARD FENCE DRAWING TEMPLATE IN gINT COMPUTER PROGRAM.

GRANULAR MATERIALS- RELATIVE DENSITY	AUTOMATIC HAMMER SPT N-VALUE (BLOWS/FOOT)	SILTS AND CLAYS CONSISTENCY	AUTOMATIC HAMMER SPT N-VALUE (BLOWS/FOOT)
VERY LOOSE	LESS THAN 3	VERY SOFT	LESS THAN 1
LOOSE	3 TO 8	SOFT	1 TO 3
MEDIUM DENSE	8 TO 24	FIRM	3 TO 6
DENSE	24 TO 40	STIFF	6 TO 12
VERY DENSE	GREATER THAN 40	VERY STIFF	12 TO 24
		HARD	GREATER THAN 24

WHILE THE BORINGS ARE REPRESENTATIVE OF SUBSURFACE CONDITIONS AT THEIR RESPECTIVE LOCATIONS AND FOR THEIR RESPECTIVE VERTICAL REACHES, LOCAL VARIATIONS CHARACTERISTIC OF THE SUBSURFACE MATERIALS OF THE REGION ARE ANTICIPATED AND MAY BE ENCOUNTERED. THE BORING LOGS AND RELATED INFORMATION ARE BASED ON THE DRILLER'S LOGS AND VISUAL EXAMINATION OF SELECTED SAMPLES IN THE LABORATORY. THE DELINEATION BETWEEN SOIL TYPES SHOWN ON THE LOGS IS APPROXIMATE AND THE DESCRIPTION REPRESENTS OUR INTERPRETATION OF SUBSURFACE CONDITIONS AT THE DESIGNATED BORING LOCATIONS ON THE PARTICULAR DATE DRILLED.

FENCE DIAGRAMS

Ardaman & Associates, Inc.
Geotechnical, Environmental and
Materials Consultants

**SUBSURFACE SOIL EXPLORATION AND
GEOTECHNICAL ENGINEERING EVALUATION
LAKE OKEECHOBEE COMPONENT A RESTORATION
HIGHLANDS COUNTY, FLORIDA**

DRAWN BY: CD		DATE: 06/26/23
FILE NO. 23-6363	APPROVED BY: Colin T. Jewsbury, P.E.	FIGURE: 6

APPENDIX I

Standard Penetration Test and CPT Procedures

STANDARD PENETRATION TEST

The standard penetration test is a widely accepted test method of *in situ* testing of soils (ASTM D-1586), and Ardaman & Associates generally follows this test method. A 2-foot long, 2-inch O.D. split-barrel sampler attached to the end of a string of drilling rods is driven 18 or 24 inches into the ground by successive blows of a 140-pound hammer freely dropping 30 inches. The number of blows needed for each 6 inches of penetration is recorded. The sum of the blows required for penetration of the second and third 6-inch increments of penetration constitutes the test result or N-value. After the test, the sampler is extracted from the ground and opened to allow visual examination and classification of the retained soil sample. The N-value has been empirically correlated with various soil properties.

All SPT borings were performed using an automatic hammer and AWJ type rods to the boring termination depth. Automatic hammer N-values may be converted to equivalent safety hammer values by multiplying by 1.24.

The tests are usually performed at 5-foot intervals. The test holes are advanced to the test elevations by rotary drilling with a cutting bit, using circulating fluid to remove the cuttings and hold the fine grains in suspension. The circulating fluid, which is a bentonitic drilling mud, is also used to keep the hole open below the water table by maintaining an excess hydrostatic pressure inside the hole. In some soil deposits, particularly highly pervious ones, flush-coupled casing must be driven to just above the testing depth to keep the hole open and/or prevent the loss of circulating fluid.

Representative split-spoon samples from the soils are brought to our laboratory in air-tight jars for further evaluation and testing, if necessary.

CONE PENETRATION TEST

The Cone Penetrometer is an in situ deep-testing device similar to the mechanical Dutch Cone Penetrometer, but utilizes electrical transducers rather than analog gauges to obtain a nearly continuous subsurface profile. This data is then used to evaluate in situ soil properties, such as soil strength and compressibility, versus depth.

The cone has a sixty-degree apex with a pore pressure sensing element behind the tip and provides a record of tip resistance, sleeve friction resistance and penetration pore pressure with depth. The cone is advanced in one-meter increments at a relatively constant rate of approximately 2 centimeters per second using the hydraulic press of a specialized cone truck. During penetration, semiconductor strain gauge-type load transducers located within the device housing are monitored at the surface. Electrical signals from the point and sleeve load cells are transmitted to the surface through a cable housed within the cone rod string. Specialized data acquisition hardware and software is used to record readings from the transducers at a frequency of approximately 1 reading per inch. These electrical signal readings are then converted to engineering units of stress using device-specific calibration factors.

APPENDIX II

Soil Boring Logs, CPT Sounding Profiles, and CPT Dissipation Test Results

DRILLING LOG (Cont Sheet)		INSTALLATION		SHEET 2 OF 4 SHEETS	
PROJECT Lake Okeechobee Component A Reservoir		COORDINATE SYSTEM State Plane		HORIZONTAL VERTICAL NAVD88	
LOCATION COORDINATES N 1,077,304.0 E 620,698.0		ELEVATION TOP OF BORING 37.9			

ELEV	DEPTH	LEGEND	FIELD CLASSIFICATION OF MATERIALS (Description)	% REC	Samp No.	RQD %	REMARKS	Blows/ 0.5 ft	N-Value
0.9	37.0	[Diagonal Hatching]	CLAYEY SAND (SC), dark gray, fine <i>(continued)</i>				PP: 2.0, NM: 51, -200: 52, LL 86, PI: 50 PP: 3.5	0	
			SANDY CLAY (CH), dark gray	33	13			3	8
-4.1	42.0	[Diagonal Hatching]	CLAYEY SAND (SC), light gray, fine, with trace shell, trace phosphate	100	14		PP: 0.5, -200: 33	2	4
								2	
		[Diagonal Hatching]	with trace cemented nodules	100	15		NM: 37, -200: 40, LL: 46, PI: 20	0	1
								0	
		[Diagonal Hatching]	green gray, with no cemented nodules	100	16			5	8
								4	
		[Diagonal Hatching]	light gray, with some cemented nodules	100	17			0	3
								2	
		[Diagonal Hatching]		133	18			0	WOH
								0	
		[Diagonal Hatching]		100	19			0	10
								2	
		[Diagonal Hatching]		0	20			4	9
								3	
		[Diagonal Hatching]						6	

DRILLING LOG (Cont Sheet)		INSTALLATION	SHEET 3 OF 4 SHEETS
PROJECT Lake Okeechobee Component A Reservoir		COORDINATE SYSTEM State Plane	HORIZONTAL VERTICAL NAVD88
LOCATION COORDINATES N 1,077,304.0 E 620,698.0		ELEVATION TOP OF BORING 37.9	

ELEV	DEPTH	LEGEND	FIELD CLASSIFICATION OF MATERIALS (Description)	% REC	Samp No.	ROD %	REMARKS	Blows/ 0.5 ft	N-Value
			gray, with no cemented nodules CLAYEY SAND (SC), light gray, fine, with trace shell, trace phosphate (continued)	80	21			2 3 4 7	7
			light gray, with few shell	100	22			2 3 5	8
			dark gray	100	23			0 2 2	4
				87	24			2 1 3	4
-60.1	98.0		SANDY CLAY (CH), green gray, with trace shell	100	25		Hard drilling 97.5 - 98 PP: 0.5	2 2 3	5
-64.1	102.0		CLAYEY SAND (SC), brown gray, fine	93	26		PP: 1.0	4 6 10	16
			with few shell	100	27		PP: 1.0	2 2 10	12
			with some cemented nodules, trace phosphate	100	28		PP: 2.0, -200: 33	0 3 5	8
			green gray, with trace phoshapte, trace shell, no cemented nodules	100	29			8 8 15	23

DRILLING LOG (Cont Sheet)		INSTALLATION	SHEET 4 OF 4 SHEETS
PROJECT Lake Okeechobee Component A Reservoir		COORDINATE SYSTEM State Plane	HORIZONTAL VERTICAL NAVD88
LOCATION COORDINATES N 1,077,304.0 E 620,698.0		ELEVATION TOP OF BORING 37.9	

ELEV	DEPTH	LEGEND	FIELD CLASSIFICATION OF MATERIALS (Description)	% REC	Sampl No.	RQD %	REMARKS	Blows/ 0.5 ft	N-Value
-94.1	132.0		CLAYEY SAND (SC), brown gray, fine (continued)	80	30		Hard drilling 121 - 121.5 Soft drilling 121.5 - 123.5	36 53 27	80
-104.1	142.0		SAND WITH CLAY (SP-SC), light gray, fine, with trace phosphate	100	32		-200: 11	6 6 7	13
-112.1	150.0		CLAYEY SAND (SC), green gray, fine, with trace phosphate	100	34			6 10 16	26
				100	35			9 14 19	33
								8 8 55	63

BOTTOM OF BOREHOLE AT 150.0 ft

NOTES:

- N Value: Standard penetration resistance in blows/foot
- NM: Neutral Moisture Content (ASTM D-2216)
-200: Percent Fines (ASTM D-1140)
LL: Liquid Limit (ASTM D-4318)
PI: Plasticity Index (ASTM D-4318)
PP: Pocket Penetrometer, Qu (TSF)
NP: Non-plastic
- Soils are classified in accordance with the Unified Soil Classification System (ASTM D-2487)
- Upon completion, the borehole was grouted with cement-bentonite slurry
- Boring performed using an automatic hammer to the boring termination depth. Automatic hammer values may be converted to equivalent safety hammer values by multiplying by 1.24.
- WOH = Borehole advanced by weight of hammer.
- ATD = Groundwater level depth at time of drilling

Reading Depth Notes

ATD 4.75
24 4.5

Date / Time

5/17/2023
5/18/2023

Boring Designation B-02

DRILLING LOG	DIVISION	INSTALLATION	SHEET 1 OF 3 SHEETS
1. PROJECT Lake Okeechobee Component A Reservoir Highlands County, Florida		9. COORDINATE SYSTEM State Plane	HORIZONTAL : VERTICAL NAVD88
2. HOLE NUMBER B-02		10. SIZE AND TYPE OF BIT 2 7/8" Drag Bit	
3. DRILLING AGENCY Ardaman & Associates, Inc.		11. MANUFACTURER'S DESIGNATION OF DRILL CME-45	
4. NAME OF DRILLER Josh Tiller/Jack Santiago		12. TOTAL SAMPLES DISTURBED : 43 UNDISTURBED : 3	
5. DIRECTION OF BORING <input checked="" type="checkbox"/> VERTICAL <input type="checkbox"/> INCLINED		13. TOTAL NUMBER CORE BOXES 0	
6. THICKNESS OF OVERBURDEN		14. ELEVATION GROUND WATER 31.7 5/16/23	
7. DEPTH DRILLED INTO ROCK 0.0		15. DATE BORING STARTED : 5/16/23 COMPLETED : 5/16/23	
8. TOTAL DEPTH OF BORING 100.0		16. ELEVATION TOP OF BORING 36.2	
		17. TOTAL CORE RECOVERY FOR BORING N/A	
		18. SIGNATURE AND TITLE OF INSPECTOR Victor Steck Geotechnical Engineer	

ELEV	DEPTH	LEGEND	FIELD CLASSIFICATION OF MATERIALS (Description)	% REC	Samp No.	RQD %	REMARKS	Blows/ 0.5 ft	N-Value					
34.7	1.5		SAND (SP), light gray, fine	100	1		Hand auger 0 - 4.5							
30.2	6.0		SAND WITH SILT (SP-SM), dark brown, fine	100	2		-200: 10							
				100	3									
				80	4			6 11	23					
				67	5			6 10 16	26					
27.2	9.0		SAND (SP), brown gray, fine	127	5		-200: 13	2 4	13					
				67	6			9 7						
				73	7			9 8	17					
25.2	11.0		SAND WITH CLAY (SP-SC), gray, fine	73	7		-200: 24							
				80	8			3 4 5	9					
23.2	13.0		SAND (SP), brown, fine to medium	73	9		-200: 4							
				67	10			7 10 11	21					
				67	10			9 10 11	21					
				73	11			3 3 3	6					
				73	12			4 4 4	8					
				87	13			2 1 1	2					
				10.7	25.5			SAND WITH SILT (SP-SM), dark gray, fine	67	14		-200: 7 WOH 27 - 28.5	3 1 0	1
									133	15			1 1 1	2
									40	16			1 1 2	3
				8.2	28.0			CLAYEY SAND (SC), dark gray, fine light gray, with few shell	87	17			2 2 2	4

0
5
10
15
20
25
30
35

DRILLING LOG (Cont Sheet)				INSTALLATION			SHEET 2 OF 3 SHEETS		
PROJECT				COORDINATE SYSTEM		HORIZONTAL	VERTICAL		
Lake Okeechobee Component A Reservoir				State Plane			NAVD88		
LOCATION COORDINATES				ELEVATION TOP OF BORING					
N 1,068,127.0 E 632,846.0				36.2					
ELEV	DEPTH	LEGEND	FIELD CLASSIFICATION OF MATERIALS (Description)	% REC	Sampl No.	RQD %	REMARKS	Blows/ 0.5 ft	N-Value
-4.3	40.5		CLAYEY SAND (SC), dark gray, fine (continued) with trace shell	87	18		-200: 15	2 2 3	5
				93	19			2 1 3	4
-9.3	45.5		SAND WITH SILT (SP-SM), dark gray, fine, with some shell	87	20		NM: 29, -200: 11, LL: NP, PI: NP	1 2 4	6
				60	21			3 4 3	7
-20.3	56.5		CLAYEY SAND (SC), dark gray, fine, with trace shell dark gray	93	22		Shelby tube SH-1, 48-50', NM: 34, -200: 35, LL: 39, PI: 18	4 2 2	4
				77 113	SH1 23			1 2 1	3
				107	24			1 2 2	4
				20	25			0 1 3	4
-21.8	58.0		CLAY WITH SAND (CH), green gray	133 100	26 SH2		PP: 0.5, -200: 85 Shelby tube SH-2, 57-57.5', NM: 86, -200: 88. Shelby tube SH-2, 57.5-58', NM: 82, -200: 79, LL: 101, PI: 80	1 1 3	4
-24.8	61.0		CLAYEY SAND (SC), gray, fine, with trace shell, trace phosphate	0	27			0 0 2	2
-26.8	63.0		SILTY SAND (SM), gray, fine, with trace shell, trace phosphate	0 95	28 SH-3		Shelby tube SH-3, 61-61.5', NM: 39, LL: NP, PI: NP Shelby tube SH-3 61.5 - 62' NM: 29, -200: 26 Shelby tube SH-3 62.5 - 63' NM: 30, -200: 20	2 1 2	3
			CLAYEY SAND (SC), gray, fine, with few shell, trace phosphate	0	29			2 2 3	5
				100	30		PP: 0.5	0 1 3 10	4
				133	31		PP: 0.25	1 2 2	4
				127	32		PP: 0.25	0 0 4	4
-39.3	75.5		light gray, with no shell	67	33		PP: 0.25	9 13 15	28
			SAND WITH CLAY (SP-SC), light gray, fine, with trace phosphate	73	34			15 30 34	64

DRILLING LOG (Cont Sheet)		INSTALLATION		SHEET 3 OF 3 SHEETS	
PROJECT Lake Okeechobee Component A Reservoir		COORDINATE SYSTEM State Plane		HORIZONTAL VERTICAL NAVD88	
LOCATION COORDINATES N 1,068,127.0 E 632,846.0		ELEVATION TOP OF BORING 36.2			

ELEV	DEPTH	LEGEND	FIELD CLASSIFICATION OF MATERIALS (Description)	% REC	Samp No.	RQD %	REMARKS	Blows/ 0.5 ft	N-Value		
			SAND WITH CLAY (SP-SC), light gray, fine, with trace phosphate (<i>continued</i>) with trace shell	73	35		-200: 7	14	40		
			with no shell					19		21	
								14		33	51
					87	36					
					67	37					
				with trace shell				-200: 6	14	18	
									9		9
									8		8
					53	38					
					60	39					
			with no shell				-200: 6	9	25		
								12		13	
								5		6	
				67	41						
				67	42						
			gray, with trace shell				-200: 6	7	15		
								6		9	
								7		6	
				53	43						

BOTTOM OF BOREHOLE AT 100.0 ft

- NOTES:
- N Value: Standard penetration resistance in blows/foot
 - NM: Nautral Moisture Content (ASTMD-2216)
-200: Percent Fines (ASTM D-1140)
LL: Liquid Limit (ASTM D-4318)
PI: Plasticity Index (ASTM D-4318)
PP: Pocket Penetrometer, Qu (TSF)
NP: Non-plastic
 - Soils are classified in accordance with the Unified Soil Classification System (ASTM D-2487)
 - Upon completion, the borehole was grouted with cement-bentonite slurry
 - Boring performed using an automatic hammer to the boring termination depth. Automatic hammer values may be converted to equivalent safety hammer values by multiplying by 1.24.
 - WOH = Borehole advanced by weight of hammer.
 - ATD = Groundwater level depth at time of drilling.

Reading Depth		Notes	Date / Time
ATD	4.5		5/16/2023
24	4.5		5/17/2023

Boring Designation B-03

DRILLING LOG		DIVISION	INSTALLATION	SHEET 1 OF 2 SHEETS
1. PROJECT Lake Okeechobee Component A Reservoir Highlands County, Florida			9. COORDINATE SYSTEM State Plane	HORIZONTAL VERTICAL NAVD88
2. HOLE NUMBER B-03		LOCATION COORDINATES N 1,056,984.0 E 624,353.0		10. SIZE AND TYPE OF BIT 2-7/8" Drag Bit
3. DRILLING AGENCY Ardaman & Associates, Inc.			11. MANUFACTURER'S DESIGNATION OF DRILL CME-45	
4. NAME OF DRILLER Josh Tiller/Jack Santiago			12. TOTAL SAMPLES DISTURBED 20 UNDISTURBED 0	
5. DIRECTION OF BORING <input checked="" type="checkbox"/> VERTICAL <input type="checkbox"/> INCLINED			13. TOTAL NUMBER CORE BOXES 0	
DEG FROM VERTICAL --- BEARING			14. ELEVATION GROUND WATER 23.7 6/6/23	
6. THICKNESS OF OVERBURDEN			15. DATE BORING STARTED 6/6/23 COMPLETED 6/6/23	
7. DEPTH DRILLED INTO ROCK 0.0			16. ELEVATION TOP OF BORING 27.6	
8. TOTAL DEPTH OF BORING 75.0			17. TOTAL CORE RECOVERY FOR BORING N/A	
18. SIGNATURE AND TITLE OF INSPECTOR Victor Steck Geotechnical Engineer				

ELEV	DEPTH	LEGEND	FIELD CLASSIFICATION OF MATERIALS (Description)	% REC	Sampl No.	RQD %	REMARKS	Blows/ 0.5 ft	N-Value
24.6	3.0		SAND (SP), light brown, fine	100	1		Hand auger 0 - 4.5		
23.1	4.5		CLAYEY SAND (SC), dark brown, fine	100	3				
			SAND WITH SILT (SP-SM), dark brown, fine	73	4			2	8
				87	5			4	
				100	6		-200: 12	0	1
				100	7		-200: 10	2	4
								2	
								3	5
								2	
				67	8			0	
								0	WOH
								0	
10.6	17.0		SAND (SP), gray, fine	67	9				
								5	
								7	14
								7	
5.6	22.0		SAND WITH SILT (SP-SM), gray brown, fine	80	10				
								3	
								2	3
								1	
				87	11			2	
								2	3
								1	
				87	12		-200: 7	2	
								1	3
								2	

DRILLING LOG (Cont Sheet)				INSTALLATION			SHEET 2 OF 2 SHEETS		
PROJECT				COORDINATE SYSTEM		HORIZONTAL	VERTICAL		
Lake Okeechobee Component A Reservoir				State Plane			NAVD88		
LOCATION COORDINATES				ELEVATION TOP OF BORING					
N 1,056,984.0 E 624,353.0				27.6					
ELEV	DEPTH	LEGEND	FIELD CLASSIFICATION OF MATERIALS (Description)	% REC	Sampl No.	RQD %	REMARKS	Blows/ 0.5 ft	N-Value
-9.4	37.0		SAND WITH SILT (SP-SM), gray brown, fine (continued)						
			SAND WITH CLAY (SP-SC), dark gray, fine	100	13			2 1 3	4
				87	14			2 1 4	5
				53	15			5 7 12	19
				73	16			4 6 4	10
-29.4	57.0		CLAYEY SAND (SC), green gray, fine, with trace shell	87	17			3 2 2	4
			with trace phosphate	73	18		-200: 15	4 3 5	8
-39.4	67.0		SAND WITH SILT (SP-SM), dark gray, fine, with trace phosphate	100	19			0 4 3	7
-47.4	75.0			87	20		NM: 7, -200: 12, LL: NP, PI: NP	3 4 8	12
BOTTOM OF BOREHOLE AT 75.0 ft									
						Reading Depth Notes		Date / Time	
						ATD 3.9		6/6/2023	

Boring Designation B-04

DRILLING LOG		DIVISION	INSTALLATION	SHEET 1 OF 2 SHEETS
1. PROJECT Lake Okeechobee Component A Reservoir Highlands County, Florida			9. COORDINATE SYSTEM State Plane	HORIZONTAL VERTICAL NAVD88
2. HOLE NUMBER B-04		LOCATION COORDINATES N 1,061,746.0 E 611,743.0		10. SIZE AND TYPE OF BIT 2-7/8" Drag Bit
3. DRILLING AGENCY Ardaman & Associates, Inc.			11. MANUFACTURER'S DESIGNATION OF DRILL CME-45	
4. NAME OF DRILLER Josh Tiller/Jack Santiago			12. TOTAL SAMPLES DISTURBED 20 UNDISTURBED 0	
5. DIRECTION OF BORING <input checked="" type="checkbox"/> VERTICAL <input type="checkbox"/> INCLINED			13. TOTAL NUMBER CORE BOXES 0	
DEG FROM VERTICAL --- BEARING			14. ELEVATION GROUND WATER 23.6 6/6/23	
6. THICKNESS OF OVERBURDEN			15. DATE BORING STARTED 6/6/23 COMPLETED 6/7/23	
7. DEPTH DRILLED INTO ROCK 0.0			16. ELEVATION TOP OF BORING 28.8	
8. TOTAL DEPTH OF BORING 75.0			17. TOTAL CORE RECOVERY FOR BORING N/A	
18. SIGNATURE AND TITLE OF INSPECTOR Victor Steck Geotechnical Engineer				

ELEV	DEPTH	LEGEND	FIELD CLASSIFICATION OF MATERIALS (Description)	% REC	Samp No.	RQD %	REMARKS	Blows/ 0.5 ft	N-Value
21.3	7.5		SAND (SP), light gray, fine	100	1		Hand auger 0 - 4.5		
			very light gray	100	2				
			light gray	100	3				
			brown gray	67	4				
				80	5				
6.8	22.0		SAND WITH SILT (SP-SM), dark gray, fine	73	6		-200: 11		
			gray	100	7				
			brown gray	67	8				
				80	9				
			SAND (SP), gray, fine	73	10				
			with trace shell	60	11				
			with no shell	80	12				

DRILLING LOG (Cont Sheet)				INSTALLATION			SHEET 2 OF 2 SHEETS		
PROJECT				COORDINATE SYSTEM		HORIZONTAL	VERTICAL		
Lake Okeechobee Component A Reservoir				State Plane			NAVD88		
LOCATION COORDINATES				ELEVATION TOP OF BORING					
N 1,061,746.0 E 611,743.0				28.8					
ELEV	DEPTH	LEGEND	FIELD CLASSIFICATION OF MATERIALS (Description)	% REC	Sampl No.	RQD %	REMARKS	Blows/ 0.5 ft	N-Value
-13.2	42.0		SAND (SP), gray, fine (continued)	100	13			18 38 50	50/6"
-23.2	52.0		CLAYEY SAND (SC), brown gray, fine	40	14			19 27 33	60
-23.2	52.0		CLAYEY SAND (SC), brown gray, fine	73	15		-200: 13	15 28 26	54
-33.2	62.0		SAND WITH CLAY (SP-SC), dark gray, fine	73	16			6 8 20	28
-33.2	62.0		SAND WITH CLAY (SP-SC), dark gray, fine	73	17			13 17 18	35
-46.2	75.0		SILTY SAND (SM), green gray, fine, with trace shell	100	18			3 4 4	8
-46.2	75.0		light green gray, with some shell	100	19		NM: 33, -200: 18, LL: NP, PI: NP	4 3 5	8
-46.2	75.0		light green gray, with some shell	100	20			4 8 6	14
BOTTOM OF BOREHOLE AT 75.0 ft									
				Reading Depth Notes			Date / Time		
				ATD 5.25			6/6/2023		
				24 5.5			6/7/2023		

Boring Designation B-05

DRILLING LOG		DIVISION	INSTALLATION	SHEET 1 OF 3 SHEETS
1. PROJECT Lake Okeechobee Component A Reservoir Highlands County, Florida			9. COORDINATE SYSTEM State Plane	HORIZONTAL VERTICAL NAVD88
2. HOLE NUMBER B-05		LOCATION COORDINATES N 1,069,635.0 E 601,617.0		10. SIZE AND TYPE OF BIT 2-7/8" Drag Bit
3. DRILLING AGENCY Ardaman & Associates, Inc.			11. MANUFACTURER'S DESIGNATION OF DRILL CME-45	
4. NAME OF DRILLER Josh Tiller/Jack Santiago			12. TOTAL SAMPLES DISTURBED 38 UNDISTURBED 2	
5. DIRECTION OF BORING <input checked="" type="checkbox"/> VERTICAL <input type="checkbox"/> INCLINED		DEG FROM VERTICAL	BEARING	13. TOTAL NUMBER CORE BOXES 0
6. THICKNESS OF OVERBURDEN			14. ELEVATION GROUND WATER 30.7 6/1/23	
7. DEPTH DRILLED INTO ROCK 0.0		15. DATE BORING STARTED 6/1/23 COMPLETED 6/2/23		
8. TOTAL DEPTH OF BORING 100.0		16. ELEVATION TOP OF BORING 36.2		
			17. TOTAL CORE RECOVERY FOR BORING N/A	
18. SIGNATURE AND TITLE OF INSPECTOR Victor Steck Geotechnical Engineer				

ELEV	DEPTH	LEGEND	FIELD CLASSIFICATION OF MATERIALS (Description)	% REC	Samp No.	RCD %	REMARKS	Blows/ 0.5 ft	N-Value
33.2	3.0		SAND (SP), very light gray, fine	100	1		Hand auger 0 - 4.5		
30.2	6.0		SAND (SP), dark brown, fine	100	2		NM: 22, -200: 16, OC: 4		
			SILTY SAND (SM), very dark brown, fine, with trace organics	80	3				5
			SAND WITH SILT (SP-SM), very dark brown, fine, with trace organics	67	4		-200: 4	7	
			SAND (SP), dark brown, fine	87	5			4	8
25.7	10.5		SAND (SP), dark brown, fine	87	6			3	7
			SAND (SP), dark brown, fine	87	7		-200: 6	4	21
			SAND (SP), dark brown, fine	67	8			10	10
			SAND (SP), dark brown, fine	53	9			5	10
			SAND (SP), dark brown, fine	67	10			3	12
			SAND (SP), dark brown, fine	67	11		-200: 6	7	11
18.2	18.0		SAND (SP), dark brown, fine	87	12			5	21
			SAND WITH SILT (SP-SM), brown, fine	65	13		-200: 6	12	
			SAND WITH SILT (SP-SM), brown, fine					3	15
15.7	20.5		SAND WITH SILT (SP-SM), brown, fine					6	15
			SAND (SP), light brown, fine	80	14		-200: 6	9	46
			SAND (SP), light brown, fine					18	28
			SAND (SP), light brown, fine	80	15		-200: 6	12	37
10.7	25.5		SAND (SP), light brown, fine					16	21
			SAND WITH SILT (SP-SM), brown, fine	80	16		-200: 6	7	21
8.2	28.0		SAND WITH SILT (SP-SM), brown, fine					9	21
			SAND (SP), light brown, fine	60	17		-200: 6	12	
			SAND (SP), light brown, fine					13	43
			SAND (SP), light brown, fine	67	18			18	33
3.2	33.0		SAND (SP), light brown, fine				-200: 6	5	
			SAND (SP), light brown, fine					13	33
			SAND WITH CLAY (SP-SC), dark gray, fine to medium, with few clayey sand nodules	73	19		-200: 6	20	
			SAND WITH CLAY (SP-SC), dark gray, fine to medium, with few clayey sand nodules					8	12
			SAND WITH CLAY (SP-SC), dark gray, fine to medium, with few clayey sand nodules				4	12	
			SAND WITH CLAY (SP-SC), dark gray, fine to medium, with few clayey sand nodules				8	12	

DRILLING LOG (Cont Sheet)				INSTALLATION		SHEET 2 OF 3 SHEETS			
PROJECT				COORDINATE SYSTEM		HORIZONTAL VERTICAL			
Lake Okeechobee Component A Reservoir				State Plane		NAVD88			
LOCATION COORDINATES				ELEVATION TOP OF BORING					
N 1,069,635.0 E 601,617.0				36.2					
ELEV	DEPTH	LEGEND	FIELD CLASSIFICATION OF MATERIALS (Description)	% REC	Samp No.	RQD %	REMARKS	Blows/ 0.5 ft	N-Value
0.7	35.5	[Symbol]	SAND (SP), gray, fine	67	20			3	8
-1.8	38.0							3	
		[Symbol]	SAND WITH CLAY (SP-SC), dark gray, fine	60	21			5	
								4	
								10	27
		[Symbol]					-200: 8	17	
								8	
								8	16
-6.8	43.0	[Symbol]	CLAYEY SAND (SC), dark brown, fine	87	22			8	
								8	
		[Symbol]						8	
								3	
								1	2
-9.3	45.5	[Symbol]	SANDY CLAY (CH), green gray	107	23			1	
								1	
		[Symbol]						0	
								0	WOH
								0	
		[Symbol]						0	
								0	
								0	
		[Symbol]						0	
								0	WOH
								0	
		[Symbol]						0	
								0	
								0	
		[Symbol]						0	
								0	
								0	
		[Symbol]						0	
								0	
								0	
		[Symbol]						0	
								0	
								0	
		[Symbol]						0	
								0	
								0	
		[Symbol]						0	
								0	
								0	
		[Symbol]						0	
								0	
								0	
		[Symbol]						0	
								0	
								0	
		[Symbol]						0	
								0	
								0	
		[Symbol]						0	
								0	
								0	
		[Symbol]						0	
								0	
								0	
		[Symbol]						0	
								0	
								0	
		[Symbol]						0	
								0	
								0	
		[Symbol]						0	
								0	
								0	
		[Symbol]						0	
								0	
								0	
		[Symbol]						0	
								0	
								0	
		[Symbol]						0	
								0	
								0	
		[Symbol]						0	
								0	
								0	
		[Symbol]						0	
								0	
								0	
		[Symbol]						0	
								0	
								0	
		[Symbol]						0	
								0	
								0	
		[Symbol]						0	
								0	
								0	
		[Symbol]						0	
								0	
								0	
		[Symbol]						0	
								0	
								0	
		[Symbol]						0	
								0	
								0	
		[Symbol]						0	
								0	
								0	
		[Symbol]						0	
								0	
								0	
		[Symbol]						0	
								0	
								0	
		[Symbol]						0	
								0	
								0	
		[Symbol]						0	
								0	
								0	
		[Symbol]						0	
								0	
								0	
		[Symbol]						0	
								0	
								0	
		[Symbol]						0	
								0	
								0	
		[Symbol]						0	
								0	
								0	
		[Symbol]						0	
								0	
								0	
		[Symbol]						0	
								0	
								0	
		[Symbol]						0	
								0	
								0	
		[Symbol]						0	
								0	
								0	
		[Symbol]						0	
								0	
								0	
		[Symbol]						0	
								0	
								0	
		[Symbol]						0	
								0	
								0	
		[Symbol]						0	
								0	
								0	
		[Symbol]						0	
								0	
								0	
		[Symbol]						0	
								0	
								0	
		[Symbol]						0	
								0	
								0	
		[Symbol]						0	
								0	
								0	
		[Symbol]						0	
								0	
								0	
		[Symbol]						0	
								0	
								0	
		[Symbol]						0	
								0	
								0	
		[Symbol]						0	
								0	
								0	
		[Symbol]						0	
								0	
								0	
		[Symbol]						0	
								0	
								0	
		[Symbol]						0	
								0	
								0	
		[Symbol]						0	
								0	
								0	
		[Symbol]						0	
								0	
								0	
		[Symbol]						0	
								0	
								0	
		[Symbol]						0	
								0	
								0	
		[Symbol]						0	
								0	
								0	
		[Symbol]						0	
								0	
								0	
		[Symbol]						0	
								0	
								0	
		[Symbol]						0	

DRILLING LOG (Cont Sheet)		INSTALLATION	SHEET 3 OF 3 SHEETS
PROJECT Lake Okeechobee Component A Reservoir		COORDINATE SYSTEM State Plane	HORIZONTAL VERTICAL NAVD88
LOCATION COORDINATES N 1,069,635.0 E 601,617.0		ELEVATION TOP OF BORING 36.2	

ELEV	DEPTH	LEGEND	FIELD CLASSIFICATION OF MATERIALS (Description)	% REC	Samp No.	ROD %	REMARKS	Blows/ 0.5 ft	N-Value
			CLAYEY SAND (SC), green gray, fine, with few shell, trace phosphate (continued)	87	36			6 7 7	14
			with some shell						
			SANDY CLAY (CH), green gray, with trace shell, trace phosphate	87	38		-200: 51	4 5 6	11
				127	39			3 4 4	8
-50.8	87.0			93	40			4 3 4	7

BOTTOM OF BOREHOLE AT 100.0 ft

NOTES:

- N Value: Standard penetration resistance in blows/foot
- NM: Nautral Moisture Content (ASTMD-2216)
-200: Percent Fines (ASTM D-1140)
LL: Liquid Limit (ASTM D-4318)
PI: Plasticity Index (ASTM D-4318)
PP: Pocket Penetrometer, Qu (TSF)
NP: Non-plastic
- Soils are classified in accordance with the Unified Soil Classification System (ASTM D-2487)
- Upon completion, the borehole was grouted with cement-bentonite slurry
- Boring performed using an automatic hammer to the boring termination depth. Automatic hammer values may be converted to equivalent safety hammer values by multiplying by 1.24.
- WOH = Borehole advanced by weight of hammer.
- ATD = Groundwater level depth at time of drilling.

Reading Depth Notes

ATD 5.5

Date / Time

6/1/2023

Boring Designation B-06

DRILLING LOG		DIVISION	INSTALLATION	SHEET 1 OF 3 SHEETS
1. PROJECT Lake Okeechobee Component A Reservoir Highlands County, Florida		9. COORDINATE SYSTEM State Plane		HORIZONTAL VERTICAL NAVD88
2. HOLE NUMBER B-06		LOCATION COORDINATES N 1,075,659.0 E 612,105.0		10. SIZE AND TYPE OF BIT 2-7/8" Drag Bit
3. DRILLING AGENCY Ardaman & Associates, Inc.		11. MANUFACTURER'S DESIGNATION OF DRILL CME-45		12. TOTAL SAMPLES DISTURBED 21 UNDISTURBED 1
4. NAME OF DRILLER Josh Tiller/Jack Santiago		13. TOTAL NUMBER CORE BOXES 0		14. ELEVATION GROUND WATER 34.2 5/31/23
5. DIRECTION OF BORING <input checked="" type="checkbox"/> VERTICAL <input type="checkbox"/> INCLINED		DEG FROM VERTICAL ---	BEARING	15. DATE BORING STARTED 5/31/23 COMPLETED 6/1/23
6. THICKNESS OF OVERBURDEN		16. ELEVATION TOP OF BORING 35.9		17. TOTAL CORE RECOVERY FOR BORING N/A
7. DEPTH DRILLED INTO ROCK 0.0		18. SIGNATURE AND TITLE OF INSPECTOR Victor Steck Geotechnical Engineer		
8. TOTAL DEPTH OF BORING 85.0				

ELEV	DEPTH	LEGEND	FIELD CLASSIFICATION OF MATERIALS (Description)	% REC	Samp No.	RQD %	REMARKS	Blows/ 0.5 ft	N-Value
26.9	9.0		SAND (SP), brown, fine light brown	100	1		Hand auger 0 - 4.5		
				100	2				
				100	3				
				67	4			4	10
				67	5			5	14
				67	6			6	13
3.9	32.0		SAND WITH SILT (SP-SM), brown, fine dark brown	87	7		-200: 11 NM: 22, -200: 9	6	15
								7	15
				73	8			5	9
								5	
								4	
				80	9			2	3
								1	
								2	
								2	4
3.9	32.0		CLAYEY SAND (SC), dark green gray, fine	120	11		1	1	
							0		
							1		
			100	12			1	1	

DRILLING LOG (Cont Sheet)				INSTALLATION			SHEET 2 OF 3 SHEETS		
PROJECT				COORDINATE SYSTEM		HORIZONTAL	VERTICAL		
Lake Okeechobee Component A Reservoir				State Plane			NAVD88		
LOCATION COORDINATES				ELEVATION TOP OF BORING					
N 1,075,659.0 E 612,105.0				35.9					
ELEV	DEPTH	LEGEND	FIELD CLASSIFICATION OF MATERIALS (Description)	% REC	Samp No.	RQD %	REMARKS	Blows/ 0.5 ft	N-Value
-6.1	42.0		CLAYEY SAND (SC), dark green gray, fine <i>(continued)</i>	93	13			1 2 2	4
-11.1	47.0		SANDY CLAY (CL), brown gray, with some shell	127	14		PP: 0.25, NM: 61, -200: 67	0 0 1	1
			CLAYEY SAND (SC), light gray, fine, with trace shell, trace phosphate	100	15			2 2 4	6
			light green gray, with some shell	80	SH16		Shelby tube SH-16, 52-54', NM: 31, -200: 40, LL: 33, PI: 18		
			brown gray, with trace shell	93	17			3 4 5	9
			with few cemented nodules, no shell	87	18			2 2 2	4
-36.1	72.0		SANDY CLAY (CH), green gray, with trace phosphate	87	19		NM: 28, -200: 37, LL: 41, PI: 17	4 4 5	9
-41.1	77.0			100	20			0 3 2	5

DRILLING LOG (Cont Sheet)		INSTALLATION	SHEET 3 OF 3 SHEETS
PROJECT Lake Okeechobee Component A Reservoir		COORDINATE SYSTEM State Plane	HORIZONTAL : VERTICAL : NAVD88
LOCATION COORDINATES N 1,075,659.0 E 612,105.0		ELEVATION TOP OF BORING 35.9	

ELEV	DEPTH	LEGEND	FIELD CLASSIFICATION OF MATERIALS (Description)	% REC	Samp No.	RQD %	REMARKS	Blows/ 0.5 ft	N-Value
			CLAYEY SAND (SC), green gray, fine, with trace phosphate (continued)				-200: 45		
				87	21			3	6
								2	
								4	
-49.1	85.0			113	22			4	10
							4		
								6	

BOTTOM OF BOREHOLE AT 85.0 ft

NOTES:

- N Value: Standard penetration resistance in blows/foot
- NM: Neutral Moisture Content (ASTMD-2216)
-200: Percent Fines (ASTM D-1140)
LL: Liquid Limit (ASTM D-4318)
PI: Plasticity Index (ASTM D-4318)
PP: Pocket Penetrometer, Qu (TSF)
NP: Non-plastic
- Soils are classified in accordance with the Unified Soil Classification System (ASTM D-2487)
- Upon completion, the borehole was grouted with cement-bentonite slurry
- Boring performed using an automatic hammer to the boring termination depth. Automatic hammer values may be converted to equivalent safety hammer values by multiplying by 1.24.
- WOH = Borehole advanced by weight of hammer.
- ATD = Groundwater level depth at time of drilling.

Reading Depth Notes

ATD	1.75
24	1.5

Date / Time

5/31/2023
6/1/2023

DRILLING LOG (Cont Sheet)				INSTALLATION			SHEET 2 OF 2 SHEETS		
PROJECT				COORDINATE SYSTEM		HORIZONTAL	VERTICAL		
Lake Okeechobee Component A Reservoir				State Plane			NAVD88		
LOCATION COORDINATES				ELEVATION TOP OF BORING					
N 1,066,458.0 E 618,117.0				33.8					
ELEV	DEPTH	LEGEND	FIELD CLASSIFICATION OF MATERIALS (Description)	% REC	Sampl No.	RQD %	REMARKS	Blows/ 0.5 ft	N-Value
-3.2	37.0		SILTY SAND (SM), dark green gray, fine (continued)						
			CLAYEY SAND (SC), light green gray, fine, with trace shell, trace phosphate	120	13			0 0 0	WOH
				120	14			2 1 1	2
				100	15			2 2 3	5
			brown gray, with some shell	47	16			4 2 2	4
			light green gray, with some cemented nodules, trace shell	100	17			2 1 2	3
-28.2	62.0		SANDY CLAY (CH), green gray, with trace phosphate, trace shell	100	18		PP: 0.75	0 2 2	4
				100	19			1 3 5	8
-38.2	72.0		CLAYEY SAND (SC), brown gray, fine, with little phosphate	100	20		NM: 34, -200: 44, LL: 43, PI: 22	4 3 9	12
BOTTOM OF BOREHOLE AT 75.0 ft									
						Reading Depth Notes		Date / Time	
						ATD 3		6/5/2023	
						AD 3.5		6/5/2023	

Boring Designation B-08

DRILLING LOG		DIVISION	INSTALLATION	SHEET 1 OF 3 SHEETS
1. PROJECT Lake Okeechobee Component A Reservoir Highlands County, Florida			9. COORDINATE SYSTEM State Plane	HORIZONTAL VERTICAL NAVD88
2. HOLE NUMBER B-08		LOCATION COORDINATES N 1,047,984.0 E 664,782.0		10. SIZE AND TYPE OF BIT 2-7/8" Drag Bit
3. DRILLING AGENCY Ardaman & Associates, Inc.			11. MANUFACTURER'S DESIGNATION OF DRILL CME-45	
4. NAME OF DRILLER Josh Tiller/Jack Santiago			12. TOTAL SAMPLES DISTURBED 26 UNDISTURBED 0	
5. DIRECTION OF BORING <input checked="" type="checkbox"/> VERTICAL <input type="checkbox"/> INCLINED			13. TOTAL NUMBER CORE BOXES 0	
DEG FROM VERTICAL --- BEARING			14. ELEVATION GROUND WATER 19.4 6/7/23	
6. THICKNESS OF OVERBURDEN			15. DATE BORING STARTED 6/7/23 COMPLETED 6/7/23	
7. DEPTH DRILLED INTO ROCK 0.0			16. ELEVATION TOP OF BORING 22.9	
8. TOTAL DEPTH OF BORING 105.0			17. TOTAL CORE RECOVERY FOR BORING N/A	
18. SIGNATURE AND TITLE OF INSPECTOR Victor Steck Geotechnical Engineer				

ELEV	DEPTH	LEGEND	FIELD CLASSIFICATION OF MATERIALS (Description)	% REC	Samp No.	RCD %	REMARKS	Blows/ 0.5 ft	N-Value
19.9	3.0		SAND (SP), light gray, fine	100	1		Hand auger 0 - 4.5		
				100	2				
16.9	6.0		SAND WITH SILT (SP-SM), brown, fine	100	3		-200: 13		
				73	4			3	
								4	7
								3	
				80	5			3	11
				67	6			6	
								1	
				87	7			2	5
								3	
								3	
10.9	12.0		SAND (SP), light brown, fine					6	16
								10	
			SILTY SAND (SM), brown gray, fine				-200: 6		
				93	8			4	
								4	9
								5	
5.9	17.0		SAND WITH SILT (SP-SM), brown gray, fine						
				100	9			9	28
								14	
								14	
			SAND WITH SILT (SP-SM), brown gray, fine						
				87	10			3	5
								2	
								3	
				100	11			2	4
								1	
								3	
-9.1	32.0		SAND WITH CLAY (SP-SC), gray, fine						
				53	12			6	14
								7	
								7	

DRILLING LOG (Cont Sheet)		INSTALLATION		SHEET 2 OF 3 SHEETS					
PROJECT		COORDINATE SYSTEM		HORIZONTAL VERTICAL					
Lake Okeechobee Component A Reservoir		State Plane		NAVD88					
LOCATION COORDINATES		ELEVATION TOP OF BORING							
N 1,047,984.0 E 664,782.0		22.9							
ELEV	DEPTH	LEGEND	FIELD CLASSIFICATION OF MATERIALS (Description)	% REC	Samp No.	RQD %	REMARKS	Blows/0.5 ft	N-Value
-24.1	47.0		SAND WITH CLAY (SP-SC), gray, fine (continued) dark gray	67	13			7 9 11	20
				80	14			3 3 6	9
			CLAYEY SAND (SC), light green gray, fine, with trace shell, trace phosphate with no shell	100	15			0 0 1	1
				87	16			5 6 4	10
			with trace shell	100	17		NM: 33, -200: 33, LL: 40, PI: 22	1 2 1	3
-39.1	62.0		SANDY CLAY (CH), green gray						
-41.1	64.0		CLAYEY SAND (SC), light green gray, fine, with trace shell, trace phosphate	100	18		PP: 0.5	1 2 2	4
				100	19			0 1 2	3
				100	20			4 3 3	6
			brown gray, with little shell						

DRILLING LOG (Cont Sheet)		INSTALLATION	SHEET 3 OF 3 SHEETS
PROJECT Lake Okeechobee Component A Reservoir		COORDINATE SYSTEM State Plane	HORIZONTAL VERTICAL NAVD88
LOCATION COORDINATES N 1,047,984.0 E 664,782.0		ELEVATION TOP OF BORING 22.9	

ELEV	DEPTH	LEGEND	FIELD CLASSIFICATION OF MATERIALS (Description)	% REC	Samp No.	RQD %	REMARKS	Blows/ 0.5 ft	N-Value	
			CLAYEY SAND (SC), light green gray, fine, with trace shell, trace phosphate <i>(continued)</i>	87	21		NM: 31, -200: 24, LL: 35, PI: 12	3	9	
			green gray, with trace shell					4		
								5		
					80	22			0	5
									2	
									3	
			brown gray, with few cemented nodules	87	23			2	4	
								1		
								3		
			with no cemented nodules	100	24			8	25	
								14		
								11		
			with no cemented nodules	0	25			2	5	
								2		
								3		
-82.1	105.0			100	26			2	6	
								3		
								3		








BOTTOM OF BOREHOLE AT 105.0 ft

- NOTES:
- N Value: Standard penetration resistance in blows/foot
 - NM: Nautral Moisture Content (ASTMD-2216)
-200: Percent Fines (ASTM D-1140)
LL: Liquid Limit (ASTM D-4318)
PI: Plasticity Index (ASTM D-4318)
PP: Pocket Penetrometer, Qu (TSF)
NP: Non-plastic
 - Soils are classified in accordance with the Unified Soil Classification System (ASTM D-2487)
 - Upon completion, the borehole was grouted with cement-bentonite slurry
 - Boring performed using an automatic hammer to the boring termination depth. Automatic hammer values may be converted to equivalent safety hammer values by multiplying by 1.24.
 - WOH = Borehole advanced by weight of hammer.
 - ATD = Groundwater level depth at time of drilling.






Reading Depth Notes Date / Time
ATD 3.5 6/7/2023

Boring Designation B-09

DRILLING LOG		DIVISION	INSTALLATION	SHEET 1 OF 2 SHEETS
1. PROJECT Lake Okeechobee Component A Reservoir Highlands County, Florida			9. COORDINATE SYSTEM State Plane	HORIZONTAL VERTICAL NAVD88
2. HOLE NUMBER B-09		LOCATION COORDINATES N 1,111,834.0 E 606,737.0		10. SIZE AND TYPE OF BIT 2-7/8" Drag Bit
3. DRILLING AGENCY Ardaman & Associates, Inc.			11. MANUFACTURER'S DESIGNATION OF DRILL CME-45	
4. NAME OF DRILLER Josh Tiller/Jack Santiago			12. TOTAL SAMPLES DISTURBED 20 UNDISTURBED 0	
5. DIRECTION OF BORING <input checked="" type="checkbox"/> VERTICAL <input type="checkbox"/> INCLINED		DEG FROM VERTICAL ---	BEARING	
6. THICKNESS OF OVERBURDEN			13. TOTAL NUMBER CORE BOXES 0	
7. DEPTH DRILLED INTO ROCK 0.0			14. ELEVATION GROUND WATER 39.5 6/14/23	
8. TOTAL DEPTH OF BORING 75.0			15. DATE BORING STARTED 6/14/23 COMPLETED 6/14/23	
			16. ELEVATION TOP OF BORING 43.0	
			17. TOTAL CORE RECOVERY FOR BORING N/A	
			18. SIGNATURE AND TITLE OF INSPECTOR Victor Steck Geotechnical Engineer	

ELEV	DEPTH	LEGEND	FIELD CLASSIFICATION OF MATERIALS (Description)	% REC	Samp No.	RQD %	REMARKS	Blows/ 0.5 ft	N-Value	
41.5	1.5	      	SAND (SP), gray, fine	100	1		Hand auger 0 - 4.5			
			SAND WITH SILT (SP-SM), dark brown, fine	100	2					
				100	3					
				60	4				0	
				40	5				1	2
				87	6				2	4
				87	7				1	3
31.0	12.0		SAND WITH CLAY (SP-SC), light brown, fine							
				87	8			6	12	
								6		
								6		
21.0	22.0		CLAYEY SAND (SC), brown gray, fine							
				67	9			6	9	
								5		
								4		
11.0	32.0		SANDY CLAY (CH), green gray							
				100	10			0	6	
								2		
								4		
				73	11			3	7	
								4		
								3		
				120	12			0	2	
								0		
								2		

DRILLING LOG (Cont Sheet)		INSTALLATION		SHEET 2
				OF 2 SHEETS
PROJECT		COORDINATE SYSTEM	HORIZONTAL	VERTICAL
Lake Okeechobee Component A Reservoir		State Plane		NAVD88
LOCATION COORDINATES		ELEVATION TOP OF BORING		
N 1,111,834.0 E 606,737.0		43.0		

ELEV	DEPTH	LEGEND	FIELD CLASSIFICATION OF MATERIALS (Description)	% REC	Sampl No.	RQD %	REMARKS	Blows/ 0.5 ft	N-Value
1.0	42.0		SANDY CLAY (CH), green gray <i>(continued)</i>	133	13			0 0 0	0
-9.0	52.0		SILTY SAND (SM), light green gray, with trace phosphate with trace shell	120	14			0 3 2	5
-9.0	52.0		CLAYEY SAND (SC), light gray, fine, with trace shell, trace phosphate green gray light green gray	113	16			2 1 2	3
-24.0	67.0		SANDY CLAY (CH), green gray, with trace shell, trace phosphate	120	18			0 2 2	4
-32.0	75.0		SANDY CLAY (CH), green gray, with trace shell, trace phosphate	120	19			1 2 3	5
-32.0	75.0		SANDY CLAY (CH), green gray, with trace shell, trace phosphate	133	20			1 3 4	7

BOTTOM OF BOREHOLE AT 75.0 ft

Reading Depth Notes Date / Time
 ATD 3.5 6/14/2023

Boring Designation B-10





DRILLING LOG	DIVISION	INSTALLATION	SHEET 1 OF 4 SHEETS
1. PROJECT Lake Okeechobee Component A Reservoir Highlands County, Florida		9. COORDINATE SYSTEM State Plane	HORIZONTAL : VERTICAL NAVD88
2. HOLE NUMBER B-10		10. SIZE AND TYPE OF BIT 2 7/8" Drag Bit	
3. DRILLING AGENCY Ardaman & Associates, Inc.		11. MANUFACTURER'S DESIGNATION OF DRILL CME-45	
4. NAME OF DRILLER Josh Tiller/Jack Santiago		12. TOTAL SAMPLES DISTURBED : 39 UNDISTURBED : 0	
5. DIRECTION OF BORING <input checked="" type="checkbox"/> VERTICAL <input type="checkbox"/> INCLINED		13. TOTAL NUMBER CORE BOXES 0	
6. THICKNESS OF OVERBURDEN		14. ELEVATION GROUND WATER 40.6 6/12/23	
7. DEPTH DRILLED INTO ROCK 0.0		15. DATE BORING STARTED : 6/12/23 COMPLETED : 6/12/23	
8. TOTAL DEPTH OF BORING 150.0		16. ELEVATION TOP OF BORING 46.3	
		17. TOTAL CORE RECOVERY FOR BORING N/A	
		18. SIGNATURE AND TITLE OF INSPECTOR Victor Steck Geotechnical Engineer	

ELEV	DEPTH	LEGEND	FIELD CLASSIFICATION OF MATERIALS (Description)	% REC	Samp No.	RQD %	REMARKS	Blows/ 0.5 ft	N-Value
43.3	3.0	•••••	SAND (SP), light gray, fine	100	1		Hand auger 0 - 4.5		
				100	2				
38.8	7.5	•••••	SAND WITH SILT (SP-SM), dark brown, fine	100	3				
			brown	53	4			5	9
				87	5			7	21
32.8	13.5	•••••	SAND (SP), light gray, fine	53	6			10	20
				60	7			5	14
				80	8			7	12
				53	9			5	11
24.3	22.0	/ / / / /	CLAYEY SAND (SC), brown gray, fine	100	10			6	11
				73	11			4	10
				73	12			5	12
				85	13			6	7
19.3	27.0	•••••	SAND (SP), brown gray, fine to medium	87	14			4	5
								3	
								2	
		/ / / / /	CLAYEY SAND (SC), dark gray, fine	100	15			0	4
								1	
								3	
			light green gray, with some shell	87	16			2	5
								2	
								3	

DRILLING LOG (Cont Sheet)		INSTALLATION		SHEET 2 OF 4 SHEETS	
PROJECT Lake Okeechobee Component A Reservoir		COORDINATE SYSTEM State Plane		HORIZONTAL VERTICAL NAVD88	
LOCATION COORDINATES N 1,097,611.0 E 614,312.0		ELEVATION TOP OF BORING 46.3			

ELEV	DEPTH	LEGEND	FIELD CLASSIFICATION OF MATERIALS (Description)	% REC	Sampl No.	ROD %	REMARKS	Blows/ 0.5 ft	N-Value
		[Diagonal Hatching Legend]	CLAYEY SAND (SC), dark gray, fine (continued)						
			gray, with trace shell, trace phosphate						
				27	17			1 2 3	5
				light gray, with no shell					
				87	18			1 2 2	4
				light green gray, with trace shell					
				87	19			3 2 5	7
				53	20		3 4 4	8	
-10.7	57.0								
		[Vertical Line Legend]	SILTY SAND (SM), green gray, with trace shell, trace phosphate						
				53	21			0 1 1	2
-15.7	62.0								
		[Diagonal Hatching Legend]	CLAYEY SAND (SC), gray, fine, with trace shell, trace phosphate						
				87	22			0 1 2	3
				27	23			1 2 3	5
				67	24		1 3 1	4	

DRILLING LOG (Cont Sheet)		INSTALLATION	SHEET 3 OF 4 SHEETS
PROJECT Lake Okeechobee Component A Reservoir		COORDINATE SYSTEM State Plane	HORIZONTAL VERTICAL NAVD88
LOCATION COORDINATES N 1,097,611.0 E 614,312.0		ELEVATION TOP OF BORING 46.3	

ELEV	DEPTH	LEGEND	FIELD CLASSIFICATION OF MATERIALS (Description)	% REC	Samp No.	RQD %	REMARKS	Blows/ 0.5 ft	N-Value
			CLAYEY SAND (SC), gray, fine, with trace shell, trace phosphate (continued)	100	25			1	4
								2	
			light gray	100	26			0	5
							2	3	
-40.7	87.0								
			NO RECOVERY	100	27			1	4
								2	
-45.7	92.0								
			CLAYEY SAND (SC), green gray, fine, with trace shell, trace phosphate	100	28			2	6
								3	
				100	29			0	2
							0	2	
-55.7	102.0								
			CLAY (CH), green gray	100	30			1	7
								4	
-60.7	107.0								
			CLAYEY SAND (SC), green gray, fine, with trace shell, trace phosphate	53	31			0	2
								1	
				100	32			1	3
							1	2	
				100	33			8	30
							11	19	

DRILLING LOG (Cont Sheet)		INSTALLATION	SHEET 4 OF 4 SHEETS
PROJECT Lake Okeechobee Component A Reservoir		COORDINATE SYSTEM State Plane	HORIZONTAL VERTICAL NAVD88
LOCATION COORDINATES N 1,097,611.0 E 614,312.0		ELEVATION TOP OF BORING 46.3	

ELEV	DEPTH	LEGEND	FIELD CLASSIFICATION OF MATERIALS (Description)	% REC	Sampl No.	RQD %	REMARKS	Blows/ 0.5 ft	N-Value
-85.7	132.0		CLAYEY SAND (SC), green gray, fine, with trace shell, trace phosphate (continued)	100	34			14 19 20	39
-90.7	137.0		SAND WITH CLAY (SP-SC), gray, fine	87	36			21 28 29	57
-100.7	147.0		CLAYEY SAND (SC), gray, fine	100	37			10 8 4	12
-103.7	150.0		SAND WITH CLAY (SP-SC), gray, fine	100	39			8 31 50	50/4"

BOTTOM OF BOREHOLE AT 150.0 ft

NOTES:

- N Value: Standard penetration resistance in blows/foot
- NM: Nautral Moisture Content (ASTMD-2216)
-200: Percent Fines (ASTM D-1140)
LL: Liquid Limit (ASTM D-4318)
PI: Plasticity Index (ASTM D-4318)
PP: Pocket Penetrometer, Qu (TSF)
NP: Non-plastic
- Soils are classified in accordance with the Unified Soil Classification System (ASTM D-2487)
- Upon completion, the borehole was grouted with cement-bentonite slurry
- Boring performed using an automatic hammer to the boring termination depth. Automatic hammer values may be converted to equivalent safety hammer values by multiplying by 1.24.
- WOH = Borehole advanced by weight of hammer.
- ATD = Groundwater level depth at time of drilling

Reading Depth	Notes	Date / Time
ATD 5.75		6/12/2023
24 4.5	after rainstorm	6/12/2023

Boring Designation B-11

DRILLING LOG		DIVISION	INSTALLATION	SHEET 1 OF 2 SHEETS
1. PROJECT Lake Okeechobee Component A Reservoir Highlands County, Florida			9. COORDINATE SYSTEM State Plane	HORIZONTAL VERTICAL NAVD88
2. HOLE NUMBER B-11		LOCATION COORDINATES N 1,094,558.0 E 596,485.0		10. SIZE AND TYPE OF BIT 2 7/8" Drag Bit
3. DRILLING AGENCY Ardaman & Associates, Inc.			11. MANUFACTURER'S DESIGNATION OF DRILL CME-45	
4. NAME OF DRILLER Josh Tiller/Jack Santiago			12. TOTAL SAMPLES 20	DISTURBED 0
5. DIRECTION OF BORING <input checked="" type="checkbox"/> VERTICAL <input type="checkbox"/> INCLINED			13. TOTAL NUMBER CORE BOXES 0	14. ELEVATION GROUND WATER 37.6 6/13/23
6. THICKNESS OF OVERBURDEN			15. DATE BORING 6/13/23	STARTED 6/13/23
7. DEPTH DRILLED INTO ROCK 0.0			16. ELEVATION TOP OF BORING 41.1	
8. TOTAL DEPTH OF BORING 75.0			17. TOTAL CORE RECOVERY FOR BORING N/A	
18. SIGNATURE AND TITLE OF INSPECTOR Victor Steck Geotechnical Engineer				

ELEV	DEPTH	LEGEND	FIELD CLASSIFICATION OF MATERIALS (Description)	% REC	Samp No.	RQD %	REMARKS	Blows/ 0.5 ft	N-Value
38.1	3.0		SAND (SP), light gray, fine	100	1		Hand auger 0 - 4.5		
			SAND WITH SILT (SP-SM), very dark brown, fine	100	2				
			dark brown	73	3			8	
				73	4			6	12
				73	5			5	
				73	6			4	10
33.6	7.5		SILTY SAND (SM), dark brown, fine	73	6			6	
			SAND WITH SILT (SP-SM), dark brown, fine	73	7			2	
				73	8			2	4
				73	9			2	
				73	10			3	8
				73	11			3	
29.1	12.0		SAND (SP), light brown, fine	60	8			5	
				60	9			3	7
				60	10			4	
				87	9			4	13
				87	10			5	
				87	11			8	
				67	10			7	33
				67	11			13	
				67	12			20	
14.1	27.0		SAND WITH CLAY (SP-SC), gray, fine	67	11			5	27
				67	12			11	
				67	13			16	
9.1	32.0		SANDY CLAY (CH), dark gray	100	12		PP: 0.5	0	1
				100	13			0	
				100	14			1	

Boring Designation B-11

DRILLING LOG (Cont Sheet)				INSTALLATION			SHEET 2 OF 2 SHEETS		
PROJECT				COORDINATE SYSTEM		HORIZONTAL	VERTICAL		
Lake Okeechobee Component A Reservoir				State Plane			NAVD88		
LOCATION COORDINATES				ELEVATION TOP OF BORING					
N 1,094,558.0 E 596,485.0				41.1					
ELEV	DEPTH	LEGEND	FIELD CLASSIFICATION OF MATERIALS (Description)	% REC	Sampl No.	RQD %	REMARKS	Blows/ 0.5 ft	N-Value
4.1	37.0	[Diagonal Hatching Legend]	SANDY CLAY (CH), dark gray (<i>continued</i>)				PP: 2.25 PP: 2.5		
			CLAYEY SAND (SC), green gray, fine, with trace shell	100	13			1 1 0	1
			with some shell	100	14			3 3 3	6
-5.9	47.0	[Diagonal Hatching Legend]	SANDY CLAY (CH), green gray, with trace shell	100	15			2 4 4	8
				100	16			5 6 7	13
				87	17			3 5 6	11
-20.9	62.0	[Diagonal Hatching Legend]	CLAYEY SAND (SC), light green gray, fine, with some shell, trace phosphate	80	18			6 8 8	16
				67	19			6 8 9	17
-30.9	72.0	[Vertical Line Legend]	SILTY SAND (SM), gray, fine, with trace phosphate	100	20			4 5 6	11
BOTTOM OF BOREHOLE AT 75.0 ft									
						Reading Depth Notes ATD 3.5		Date / Time 6/13/2023	

Boring Designation B-12

DRILLING LOG		DIVISION	INSTALLATION	SHEET 1 OF 2 SHEETS
1. PROJECT Lake Okeechobee Component A Reservoir Highlands County, Florida		9. COORDINATE SYSTEM State Plane		HORIZONTAL VERTICAL NAVD88
2. HOLE NUMBER B-12		LOCATION COORDINATES N 1,108,494.0 E 596,624.0		10. SIZE AND TYPE OF BIT 2 7/8" Drag Bit
3. DRILLING AGENCY Ardaman & Associates, Inc.		11. MANUFACTURER'S DESIGNATION OF DRILL CME-45		12. TOTAL SAMPLES DISTURBED 20 UNDISTURBED 0
4. NAME OF DRILLER Josh Tiller/Jack Santiago		13. TOTAL NUMBER CORE BOXES 0		14. ELEVATION GROUND WATER 38.4 6/14/23
5. DIRECTION OF BORING <input checked="" type="checkbox"/> VERTICAL <input type="checkbox"/> INCLINED		DEG FROM VERTICAL	BEARING	15. DATE BORING STARTED 6/14/23 COMPLETED 6/14/23
6. THICKNESS OF OVERBURDEN		16. ELEVATION TOP OF BORING 44.4		17. TOTAL CORE RECOVERY FOR BORING N/A
7. DEPTH DRILLED INTO ROCK 0.0		18. SIGNATURE AND TITLE OF INSPECTOR Victor Steck Geotechnical Engineer		
8. TOTAL DEPTH OF BORING 75.0				

ELEV	DEPTH	LEGEND	FIELD CLASSIFICATION OF MATERIALS (Description)	% REC	Sampl No.	RQD %	REMARKS	Blows/ 0.5 ft	N-Value
			SAND WITH SILT (SP-SM), dark brown, fine	100	1		Hand auger 0 - 4.5		
				100	2				
			brown gray	100	3				
				87	4			6	
38.4	6.0							7	16
			SAND (SP), gray, fine	100	5			9	
36.9	7.5							10	20
			SAND WITH CLAY (SP-SC), brown gray, fine	53	6			10	
35.4	9.0							3	9
			CLAYEY SAND (SC), light gray, fine	53	7			4	
								5	
32.4	12.0							3	11
			SAND WITH CLAY (SP-SC), light brown, fine				5		
				73	8		6	10	
							4		
							6	10	
							4		
22.4	22.0						5		
			CLAYEY SAND (SC), gray, fine				5	11	
				100	10		6		
							5		
17.4	27.0						5	11	
			SILTY SAND (SM), dark brown, fine with trace organics				6		
15.4	29.0						3	4	
			CLAYEY SAND (SC), gray, fine to medium	100	11		2		
							2		
							2		
							0	14	
							2		
							12		
							14		
				87	12		23	47	
							24		

DRILLING LOG (Cont Sheet)				INSTALLATION			SHEET 2 OF 2 SHEETS			
PROJECT				COORDINATE SYSTEM		HORIZONTAL	VERTICAL			
Lake Okeechobee Component A Reservoir				State Plane			NAVD88			
LOCATION COORDINATES				ELEVATION TOP OF BORING						
N 1,108,494.0 E 596,624.0				44.4						
ELEV	DEPTH	LEGEND	FIELD CLASSIFICATION OF MATERIALS (Description)	% REC	Samp No.	RQD %	REMARKS	Blows/ 0.5 ft	N-Value	
7.4	37.0		CLAYEY SAND (SC), gray, fine to medium (continued)							
			SAND WITH CLAY (SP-SC), gray, fine	67	13			7 22 17	39	
2.4	42.0		CLAYEY SAND (SC), light green gray, fine to medium, with trace shell, trace phosphate	100	14			0 0 1	1	
			fine, mostly shell	93	15			4 3 2	5	
-7.6	52.0		SANDY CLAY (CH), green gray, with trace shell, trace phosphate	100	16			3 1 2	3	
-12.6	57.0		CLAYEY SAND (SC), light gray, fine, with trace shell, trace phosphate	87	17			3 3 4	7	
			with some shell	100	18			3 4 6	10	
			gray, with no shell	100	19			3 3 6	9	
			light gray, with trace shell	100	20			3 4 4	8	
-30.6	75.0		BOTTOM OF BOREHOLE AT 75.0 ft							


Reading Depth Notes
ATD 6 Date / Time
6/14/2023

Boring Designation B-13

DRILLING LOG	DIVISION	INSTALLATION	SHEET 1 OF 2 SHEETS
1. PROJECT Lake Okeechobee Component A Reservoir Highlands County, Florida		9. COORDINATE SYSTEM State Plane	HORIZONTAL : VERTICAL NAVD88
2. HOLE NUMBER B-13		10. SIZE AND TYPE OF BIT 2-7/8" Drag Bit	
3. DRILLING AGENCY Ardaman & Associates, Inc.		11. MANUFACTURER'S DESIGNATION OF DRILL CME-45	
4. NAME OF DRILLER Josh Tiller/Jack Santiago		12. TOTAL SAMPLES DISTURBED : 13 UNDISTURBED : 0	
5. DIRECTION OF BORING <input checked="" type="checkbox"/> VERTICAL <input type="checkbox"/> INCLINED		13. TOTAL NUMBER CORE BOXES 0	
6. THICKNESS OF OVERBURDEN		14. ELEVATION GROUND WATER 38.4 8/18/23	
7. DEPTH DRILLED INTO ROCK 0.0		15. DATE BORING STARTED : 8/18/23 COMPLETED : 8/18/23	
8. TOTAL DEPTH OF BORING 40.0		16. ELEVATION TOP OF BORING 38.4	
		17. TOTAL CORE RECOVERY FOR BORING N/A	
		18. SIGNATURE AND TITLE OF INSPECTOR Victor Steck Geotechnical Engineer	

ELEV	DEPTH	LEGEND	FIELD CLASSIFICATION OF MATERIALS (Description)	% REC	Samp No.	ROD %	REMARKS	Blows/ 0.5 ft	N-Value
36.9	1.5	[Symbol]	SAND (SP), light gray, fine	100	1			1	8
36.4	2.0	[Symbol]	SAND WITH SILT (SP-SM), dark brown, fine	87	2			3	13
35.4	3.0	[Symbol]	SAND (SP), light gray, fine					5	
		[Symbol]	SAND WITH SILT (SP-SM), dark brown, fine	80	3			6	13
		[Symbol]		100	4		-200: 7	7	
32.4	6.0	[Symbol]						8	19
		[Symbol]	SAND (SP), light gray, fine	93	5			11	
30.9	7.5	[Symbol]						6	18
		[Symbol]	CLAYEY SAND (SC), gray, fine	87	6		-200: 18	8	
		[Symbol]		113	7			10	14
26.4	12.0	[Symbol]						6	16
		[Symbol]	SAND (SP), light brown, fine	33	8			8	
		[Symbol]						5	12
21.4	17.0	[Symbol]						6	
		[Symbol]	SAND WITH CLAY (SP-SC), gray, fine	100	9			1	5
		[Symbol]						1	
16.4	22.0	[Symbol]						4	
		[Symbol]	SAND (SP), light gray, fine	87	10			6	12
		[Symbol]						7	
11.4	27.0	[Symbol]						5	
		[Symbol]	CLAYEY SAND (SC), dark green gray, fine	100	11		NM: 28, -200: 13, LL: 32, PI: 10	2	2
		[Symbol]						1	
6.4	32.0	[Symbol]						1	
		[Symbol]	SAND WITH CLAY (SP-SC), green gray, fine, with few shell, trace phosphate	113	12			2	
		[Symbol]						7	16
		[Symbol]						9	
		[Symbol]						7	

DRILLING LOG (Cont Sheet)		INSTALLATION		SHEET 2 OF 2 SHEETS	
PROJECT Lake Okeechobee Component A Reservoir		COORDINATE SYSTEM State Plane		HORIZONTAL VERTICAL NAVD88	
LOCATION COORDINATES N 1,075,640.0 E 623,206.0		ELEVATION TOP OF BORING 38.4			

ELEV	DEPTH	LEGEND	FIELD CLASSIFICATION OF MATERIALS (Description)	% REC	Samp No.	RQD %	REMARKS	Blows/ 0.5 ft	N-Value
-1.6	40.0		SAND WITH CLAY (SP-SC), green gray, fine, with few shell, trace phosphate (<i>continued</i>) brown gray, with trace shell	87	13		-200: 6	10 12 11	23


BOTTOM OF BOREHOLE AT 40.0 ft

Reading Depth Notes Date / Time
ATD 0 8/18/2023

NOTES:

1. N Value: Standard penetration resistance in blows/foot
2. NM: Nautral Moisture Content (ASTMD-2216)
-200: Percent Fines (ASTM D-1140)
LL: Liquid Limit (ASTM D-4318)
PI: Plasticity Index (ASTM D-4318)
PP: Pocket Penetrometer, Qu (TSF)
NP: Non-plastic
3. Soils are classified in accordance with the Unified Soil Classification System (ASTM D-2487)
4. Upon completion, the borehole was grouted with cement-bentonite slurry
5. Boring performed using an automatic hammer to the boring termination depth. Automatic hammer values may be converted to equivalent safety hammer values by multiplying by 1.24.
6. WOH = Borehole advanced by weight of hammer.
7. ATD = Groundwater level depth at time of drilling.

DRILLING LOG (Cont Sheet)		INSTALLATION		SHEET 2 OF 2 SHEETS	
PROJECT Lake Okeechobee Component A Reservoir		COORDINATE SYSTEM State Plane		HORIZONTAL VERTICAL NAVD88	
LOCATION COORDINATES N 1,076,428.0 E 628,149.0		ELEVATION TOP OF BORING 37.6			

ELEV	DEPTH	LEGEND	FIELD CLASSIFICATION OF MATERIALS (Description)	% REC	Sampl No.	RQD %	REMARKS	Blows/ 0.5 ft	N-Value
-7.4	45.0		CLAYEY SAND (SC), light gray, fine, with trace shell <i>(continued)</i> light green gray, with trace phosphate mostly shell						
				133	13			0 0 2	2
				100	14			3 2 3	5

BOTTOM OF BOREHOLE AT 45.0 ft

NOTES:

- N Value: Standard penetration resistance in blows/foot
- NM: Nautral Moisture Content (ASTMD-2216)
-200: Percent Fines (ASTM D-1140)
LL: Liquid Limit (ASTM D-4318)
PI: Plasticity Index (ASTM D-4318)
PP: Pocket Penetrometer, Qu (TSF)
NP: Non-plastic
- Soils are classified in accordance with the Unified Soil Classification System (ASTM D-2487)
- Upon completion, the borehole was grouted with cement-bentonite slurry
- Boring performed using an automatic hammer to the boring termination depth. Automatic hammer values may be converted to equivalent safety hammer values by multiplying by 1.24.
- WOH = Borehole advanced by weight of hammer.
- ATD = Groundwater level depth at time of drilling.

Reading Depth Notes

ATD 0

Date / Time

8/21/2023

DRILLING LOG (Cont Sheet)		INSTALLATION		SHEET 2 OF 2 SHEETS	
PROJECT Lake Okeechobee Component A Reservoir		COORDINATE SYSTEM State Plane		HORIZONTAL VERTICAL NAVD88	
LOCATION COORDINATES N 1,073,734.0 E 631,944.0		ELEVATION TOP OF BORING 39.1			

ELEV	DEPTH	LEGEND	FIELD CLASSIFICATION OF MATERIALS (Description)	% REC	Sampl No.	RQD %	REMARKS	Blows/ 0.5 ft	N-Value
2.1	37.0		CLAYEY SAND (SC), green gray, fine, with trace shell, trace phosphate (<i>continued</i>)				NM: 57, -200: 79, LL: 86, PI: 61		
			CLAY WITH SAND (CH), light green gray	133	13			0	3
								0	
-2.9	42.0		CLAYEY SAND (SC), light green gray, fine, with trace shell, trace phosphate, trace cemented nodules						
				133	14			1	
-5.9	45.0							4	8
								4	

BOTTOM OF BOREHOLE AT 45.0 ft

NOTES:



- N Value: Standard penetration resistance in blows/foot
- NM: Nautral Moisture Content (ASTMD-2216)
-200: Percent Fines (ASTM D-1140)
LL: Liquid Limit (ASTM D-4318)
PI: Plasticity Index (ASTM D-4318)
PP: Pocket Penetrometer, Qu (TSF)
NP: Non-plastic
- Soils are classified in accordance with the Unified Soil Classification System (ASTM D-2487)
- Upon completion, the borehole was grouted with cement-bentonite slurry
- Boring performed using an automatic hammer to the boring termination depth. Automatic hammer values may be converted to equivalent safety hammer values by multiplying by 1.24.
- WOH = Borehole advanced by weight of hammer.
- ATD = Groundwater level depth at time of drilling.


Reading Depth Notes Date / Time
ATD 0.25 8/21/2023

Boring Designation B-16

DRILLING LOG	DIVISION	INSTALLATION	SHEET 1 OF 2 SHEETS
1. PROJECT Lake Okeechobee Component A Reservoir Highlands County, Florida		9. COORDINATE SYSTEM State Plane	HORIZONTAL VERTICAL NAVD88
2. HOLE NUMBER B-16		10. SIZE AND TYPE OF BIT 2-7/8" Drag Bit	
3. DRILLING AGENCY Ardaman & Associates, Inc.		11. MANUFACTURER'S DESIGNATION OF DRILL CME-45	
4. NAME OF DRILLER Josh Tiller/Jack Santiago		12. TOTAL SAMPLES DISTURBED 14 UNDISTURBED 0	
5. DIRECTION OF BORING <input checked="" type="checkbox"/> VERTICAL <input type="checkbox"/> INCLINED		13. TOTAL NUMBER CORE BOXES 0	
6. THICKNESS OF OVERBURDEN		14. ELEVATION GROUND WATER 34.7 8/22/23	
7. DEPTH DRILLED INTO ROCK 0.0		15. DATE BORING STARTED 8/22/23 COMPLETED 8/22/23	
8. TOTAL DEPTH OF BORING 45.0		16. ELEVATION TOP OF BORING 34.7	
		17. TOTAL CORE RECOVERY FOR BORING N/A	
		18. SIGNATURE AND TITLE OF INSPECTOR Victor Steck Geotechnical Engineer	

ELEV	DEPTH	LEGEND	FIELD CLASSIFICATION OF MATERIALS (Description)	% REC	Samp No.	ROD %	REMARKS	Blows/ 0.5 ft	N-Value
33.2	1.5		SAND (SP), light gray, fine	60	1		-200: 7	2	6
			SAND WITH SILT (SP-SM), brown, fine	100	2			3	12
				120	3			4	
30.2	4.5		SAND (SP), light brown, fine	80	4			5	11
				100	5			6	
				120	6			7	16
25.7	9.0		SAND (SP), very light brown, fine	80	7			8	8
				100	8			9	15
				120	9			10	13
22.7	12.0		CLAYEY SAND (SC), brown gray, fine	80	10			11	13
			SAND (SP), light brown, fine to medium	60	11			12	22
			light brown, fine to medium	60	12			13	22
			brown, fine	53	13		14	17	
7.7	27.0		SAND WITH CLAY (SP-SC), dark green gray, fine	133	14		15	0	
				133	15		16	0	
				133	16		17	0	
				133	17		18	0	
				133	18		19	0	
				133	19		20	0	
				133	20		21	0	
				133	21		22	0	
				133	22		23	0	
				133	23		24	0	
				133	24		25	0	
				133	25		26	0	
				133	26		27	0	
				133	27		28	0	
				133	28		29	0	
				133	29		30	0	
				133	30		31	0	
				133	31		32	0	
				133	32		33	0	
				133	33		34	0	
				133	34		35	0	
				133	35		36	0	
				133	36		37	0	
				133	37		38	0	
				133	38		39	0	
				133	39		40	0	
				133	40		41	0	
				133	41		42	0	
				133	42		43	0	
				133	43		44	0	
				133	44		45	0	
				133	45		46	0	
				133	46		47	0	
				133	47		48	0	
				133	48		49	0	
				133	49		50	0	
				133	50		51	0	
				133	51		52	0	
				133	52		53	0	
				133	53		54	0	
				133	54		55	0	
				133	55		56	0	
				133	56		57	0	
				133	57		58	0	
				133	58		59	0	
				133	59		60	0	
				133	60		61	0	
				133	61		62	0	
				133	62		63	0	
				133	63		64	0	
				133	64		65	0	
				133	65		66	0	
				133	66		67	0	
				133	67		68	0	
				133	68		69	0	
				133	69		70	0	
				133	70		71	0	
				133	71		72	0	
				133	72		73	0	
				133	73		74	0	
				133	74		75	0	
				133	75		76	0	
				133	76		77	0	
				133	77		78	0	
				133	78		79	0	
				133	79		80	0	
				133	80		81	0	
				133	81		82	0	
				133	82		83	0	
				133	83		84	0	
				133	84		85	0	
				133	85		86	0	
				133	86		87	0	
				133	87		88	0	
				133	88		89	0	
				133	89		90	0	
				133	90		91	0	
				133	91		92	0	
				133	92		93	0	
				133	93		94	0	
				133	94		95	0	
				133	95		96	0	
				133	96		97	0	
				133	97		98	0	
				133	98		99	0	
				133	99		100	0	


DRILLING LOG (Cont Sheet)				INSTALLATION			SHEET 2 OF 2 SHEETS		
				PROJECT Lake Okeechobee Component A Reservoir			COORDINATE SYSTEM State Plane		HORIZONTAL : VERTICAL : NAVD88
LOCATION COORDINATES N 1,065,551.0 E 631,990.0				ELEVATION TOP OF BORING 34.7					
ELEV	DEPTH	LEGEND	FIELD CLASSIFICATION OF MATERIALS (Description)	% REC	Samp No.	ROD %	REMARKS	Blows/ 0.5 ft	N-Value
-2.3	37.0		SAND WITH CLAY (SP-SC), dark green gray, fine <i>(continued)</i>						
			CLAYEY SAND (SC), light green gray, with few shell, trace phosphate	113	13			0 1 2	3
			with some shell						
-10.3	45.0			80	14			4 5 5	10
BOTTOM OF BOREHOLE AT 45.0 ft									
NOTES: 1. N Value: Standard penetration resistance in blows/foot 2. NM: Nautral Moisture Content (ASTMD-2216) -200: Percent Fines (ASTM D-1140) LL: Liquid Limit (ASTM D-4318) PI: Plasticity Index (ASTM D-4318) PP: Pocket Penetrometer, Qu (TSF) NP: Non-plastic 3. Soils are classified in accordance with the Unified Soil Classification System (ASTM D-2487) 4. Upon completion, the borehole was grouted with cement-bentonite slurry 5. Boring performed using an automatic hammer to the boring termination depth. Automatic hammer values may be converted to equivalent safety hammer values by multiplying by 1.24. 6. WOH = Borehole advanced by weight of hammer. 7. ATD = Groundwater level depth at time of drilling.				Reading Depth Notes ATD 0		Date / Time 8/22/2023			

DRILLING LOG (Cont Sheet)				INSTALLATION			SHEET 2 OF 2 SHEETS		
				PROJECT Lake Okeechobee Component A Reservoir			COORDINATE SYSTEM State Plane		HORIZONTAL : VERTICAL NAVD88
LOCATION COORDINATES N 1,060,907.0 E 621,480.0				ELEVATION TOP OF BORING 28.4					
ELEV	DEPTH	LEGEND	FIELD CLASSIFICATION OF MATERIALS (Description)	% REC	Samp No.	RQD %	REMARKS	Blows/ 0.5 ft	N-Value
-11.6	40.0		SAND WITH CLAY (SP-SC), gray, fine (continued)	53	13			7 13 14	27
BOTTOM OF BOREHOLE AT 40.0 ft									
NOTES: 1. N Value: Standard penetration resistance in blows/foot 2. NM: Nautral Moisture Content (ASTMD-2216) -200: Percent Fines (ASTM D-1140) LL: Liquid Limit (ASTM D-4318) PI: Plasticity Index (ASTM D-4318) PP: Pocket Penetrometer, Qu (TSF) NP: Non-plastic 3. Soils are classified in accordance with the Unified Soil Classification System (ASTM D-2487) 4. Upon completion, the borehole was grouted with cement-bentonite slurry 5. Boring performed using an automatic hammer to the boring termination depth. Automatic hammer values may be converted to equivalent safety hammer values by multiplying by 1.24. 6. WOH = Borehole advanced by weight of hammer. 7. ATD = Groundwater level depth at time of drilling.				Reading Depth Notes ATD 0.9		Date / Time 8/23/2023			

DRILLING LOG (Cont Sheet)		INSTALLATION		SHEET 2 OF 3 SHEETS	
PROJECT Lake Okeechobee Component A Reservoir		COORDINATE SYSTEM State Plane		HORIZONTAL VERTICAL NAVD88	
LOCATION COORDINATES N 1,063,881.0 E 618,490.0		ELEVATION TOP OF BORING 29.1			

ELEV	DEPTH	LEGEND	FIELD CLASSIFICATION OF MATERIALS (Description)	% REC	Samp No.	RQD %	REMARKS	Blows/ 0.5 ft	N-Value
-12.9	42.0		SAND WITH CLAY (SP-SC), green gray, fine, with trace shell, trace phosphate <i>(continued)</i>	67	13		NM: 30, -200: 21, LL: NP, PI: NP	5 4 4	8
-17.9	47.0		SILTY SAND (SM), light green gray, fine, with some shell, trace phosphate	67	14			0 1 2	3
			CLAYEY SAND (SC), light green gray, fine, with some shell, trace phosphate	80	15			6 7 7	14
			mostly shell	67	16			5 3 6	9
			with few shell	93	17			4 4 3	7
			with trace shell	107	18			2 2 3	5
			green gray	13	19			3 2 5	7
				133	20			1 2 3	5
								-200: 28	

DRILLING LOG (Cont Sheet)		INSTALLATION		SHEET 3 OF 3 SHEETS	
PROJECT Lake Okeechobee Component A Reservoir		COORDINATE SYSTEM State Plane		HORIZONTAL VERTICAL NAVD88	
LOCATION COORDINATES N 1,063,881.0 E 618,490.0		ELEVATION TOP OF BORING 29.1			

ELEV	DEPTH	LEGEND	FIELD CLASSIFICATION OF MATERIALS (Description)	% REC	Samp No.	RQD %	REMARKS	Blows/ 0.5 ft	N-Value
-50.9	80.0		CLAYEY SAND (SC), light green gray, fine, with some shell, trace phosphate (continued)	73	21		NM: 38, -200: 23, LL: 44, PI: 18	1 2 3	5

BOTTOM OF BOREHOLE AT 80.0 ft

NOTES:

- N Value: Standard penetration resistance in blows/foot
- NM: Nautral Moisture Content (ASTMD-2216)
-200: Percent Fines (ASTM D-1140)
LL: Liquid Limit (ASTM D-4318)
PI: Plasticity Index (ASTM D-4318)
PP: Pocket Penetrometer, Qu (TSF)
NP: Non-plastic
- Soils are classified in accordance with the Unified Soil Classification System (ASTM D-2487)
- Upon completion, the borehole was grouted with cement-bentonite slurry
- Boring performed using an automatic hammer to the boring termination depth. Automatic hammer values may be converted to equivalent safety hammer values by multiplying by 1.24.
- WOH = Borehole advanced by weight of hammer.
- ATD = Groundwater level depth at time of drilling.

Reading Depth Notes Date / Time
ATD 0.7 8/23/2023

80

Boring Designation B-19

DRILLING LOG		DIVISION	INSTALLATION	SHEET 1 OF 3 SHEETS
1. PROJECT Lake Okeechobee Component A Reservoir Highlands County, Florida			9. COORDINATE SYSTEM State Plane	HORIZONTAL VERTICAL NAVD88
2. HOLE NUMBER B-19		LOCATION COORDINATES N 1,062,444.0 E 610,063.0		10. SIZE AND TYPE OF BIT 2-7/8" Drag Bit
3. DRILLING AGENCY Ardaman & Associates, Inc.			11. MANUFACTURER'S DESIGNATION OF DRILL CME-45	
4. NAME OF DRILLER Josh Tiller/Jack Santiago			12. TOTAL SAMPLES DISTURBED 21 UNDISTURBED 0	
5. DIRECTION OF BORING <input checked="" type="checkbox"/> VERTICAL <input type="checkbox"/> INCLINED			13. TOTAL NUMBER CORE BOXES 0	
DEG FROM VERTICAL --- BEARING			14. ELEVATION GROUND WATER 26.7 8/14/23	
6. THICKNESS OF OVERBURDEN			15. DATE BORING STARTED 8/14/23 COMPLETED 8/14/23	
7. DEPTH DRILLED INTO ROCK 0.0			16. ELEVATION TOP OF BORING 29.9	
8. TOTAL DEPTH OF BORING 80.0			17. TOTAL CORE RECOVERY FOR BORING N/A	
18. SIGNATURE AND TITLE OF INSPECTOR Victor Steck Geotechnical Engineer				

ELEV	DEPTH	LEGEND	FIELD CLASSIFICATION OF MATERIALS (Description)	% REC	Samp No.	ROD %	REMARKS	Blows/ 0.5 ft	N-Value
28.4	1.5		SAND WITH SILT (SP-SM), very dark brown, fine, with trace roots, trace organics	100	1		Hand auger 0 - 4.5		
25.4	4.5		SAND WITH CLAY (SP-SC), light orange brown, fine, with few limerock nodules	100	2		NM: 28, -200: 36, OC: 2		
			light brown, with no limerock nodules	100	3				
23.9	6.0		SILTY SAND (SM), light brown, fine	87	4			3 2 3	5
20.9	9.0		SAND WITH SILT (SP-SM), light brown, fine	107	5			3 6 7	13
				120	6			4 3	7
17.9	12.0		CLAYEY SAND (SC), dark brown, fine, with trace organics	53	7			3 1 1	2
12.9	17.0		SAND WITH CLAY (SP-SC), brown gray, fine	53	8			4 6 5	11
			SAND (SP), brown gray, fine	67	9		-200: 5	4 6 3	9
			gray	67	10			6 9 8	17
			light gray	80	11			7 10 14	24
				73	12			25 41 40	81

DRILLING LOG (Cont Sheet)		INSTALLATION		SHEET 2 OF 3 SHEETS
PROJECT Lake Okeechobee Component A Reservoir		COORDINATE SYSTEM State Plane	HORIZONTAL	VERTICAL NAVD88
LOCATION COORDINATES N 1,062,444.0 E 610,063.0		ELEVATION TOP OF BORING 29.9		

ELEV	DEPTH	LEGEND	FIELD CLASSIFICATION OF MATERIALS (Description)	% REC	Sampl No.	RQD %	REMARKS	Blows/ 0.5 ft	N-Value
-12.1	42.0		SAND (SP), brown gray, fine (continued) brown gray	53	13		-200: 3	25 38 50	50/3"
-22.1	52.0		SAND WITH CLAY (SP-SC), gray, fine	47	14			34 50	50/5"
			CLAYEY SAND (SC), green gray, fine, with trace shell, trace phosphate	67	15			45 27 14	41
				100	16		-200: 15	8 8 6	14
			with some shell	80	17			2 5 6	11
			with some cemented shell nodules	80	18			12 11 10	21
			light green gray, with trace shell, no cemented shell nodules	80	19			3 3 4	7
			green gray	120	20		NM: 60, -200: 40, LL: 41, PI: 22	3 6 6	12

DRILLING LOG (Cont Sheet)				INSTALLATION			SHEET 3 OF 3 SHEETS		
				PROJECT Lake Okeechobee Component A Reservoir			COORDINATE SYSTEM State Plane		HORIZONTAL VERTICAL NAVD88
LOCATION COORDINATES N 1,062,444.0 E 610,063.0				ELEVATION TOP OF BORING 29.9					
ELEV	DEPTH	LEGEND	FIELD CLASSIFICATION OF MATERIALS (Description)	% REC	Samp No.	RQD %	REMARKS	Blows/ 0.5 ft	N-Value
-50.1	80.0	[Hatched Box]	CLAYEY SAND (SC), green gray, fine, with trace shell, trace phosphate (<i>continued</i>)	100	21			3 3 4	7
BOTTOM OF BOREHOLE AT 80.0 ft									
NOTES: 1. N Value: Standard penetration resistance in blows/foot 2. NM: Nautral Moisture Content (ASTMD-2216) -200: Percent Fines (ASTM D-1140) LL: Liquid Limit (ASTM D-4318) PI: Plasticity Index (ASTM D-4318) PP: Pocket Penetrometer, Qu (TSF) NP: Non-plastic 3. Soils are classified in accordance with the Unified Soil Classification System (ASTM D-2487) 4. Upon completion, the borehole was grouted with cement-bentonite slurry 5. Boring performed using an automatic hammer to the boring termination depth. Automatic hammer values may be converted to equivalent safety hammer values by multiplying by 1.24. 6. WOH = Borehole advanced by weight of hammer. 7. ATD = Groundwater level depth at time of drilling.				Reading Depth Notes ATD 3.2		Date / Time 8/14/2023			

80

Boring Designation B-20

DRILLING LOG		DIVISION	INSTALLATION	SHEET 1 OF 3 SHEETS
1. PROJECT Lake Okeechobee Component A Reservoir Highlands County, Florida		9. COORDINATE SYSTEM State Plane		HORIZONTAL VERTICAL NAVD88
2. HOLE NUMBER B-20		LOCATION COORDINATES N 1,066,287.0 E 601,563.0		10. SIZE AND TYPE OF BIT 3-7/8" Tricone
3. DRILLING AGENCY Ardaman & Associates, Inc.		11. MANUFACTURER'S DESIGNATION OF DRILL CME-45		12. TOTAL SAMPLES DISTURBED 21 UNDISTURBED 0
4. NAME OF DRILLER Josh Tiller/Jack Santiago		13. TOTAL NUMBER CORE BOXES 0		14. ELEVATION GROUND WATER 26.8 8/24/23
5. DIRECTION OF BORING <input checked="" type="checkbox"/> VERTICAL <input type="checkbox"/> INCLINED		DEG FROM VERTICAL ---	BEARING	15. DATE BORING STARTED 8/24/23 COMPLETED 8/28/23
6. THICKNESS OF OVERBURDEN		16. ELEVATION TOP OF BORING 29.3		17. TOTAL CORE RECOVERY FOR BORING N/A
7. DEPTH DRILLED INTO ROCK 0.0		18. SIGNATURE AND TITLE OF INSPECTOR Victor Steck Geotechnical Engineer		
8. TOTAL DEPTH OF BORING 80.0				

ELEV	DEPTH	LEGEND	FIELD CLASSIFICATION OF MATERIALS (Description)	% REC	Samp No.	ROD %	REMARKS	Blows/ 0.5 ft	N-Value
26.3	3.0		SAND WITH SILT (SP-SM), very light gray, fine brown	100	1		Hand auger 0 - 4.5 -200: 9		
				100	2				
24.8	4.5		CLAYEY SAND (SC), gray, fine	100	3				
23.3	6.0		SAND WITH CLAY (SP-SC), brown, fine	113	4			11 9	18
21.8	7.5		CLAYEY SAND (SC), brown, fine	133	5			10 10 14	24
			SAND WITH SILT (SP-SM), brown, fine	107	6			11 10 13	23
				87	7			13 19 24	43
17.3	12.0		SAND WITH CLAY (SP-SC), brown gray, fine	60	8			10 9 7	16
				47	9			0 4 5	9
			gray	73	10		-200: 6	4 5 6	11
				73	11			2 2 7	9
				73	12			4 5 14	19

DRILLING LOG (Cont Sheet)				INSTALLATION			SHEET 2 OF 3 SHEETS		
PROJECT Lake Okeechobee Component A Reservoir				COORDINATE SYSTEM State Plane		HORIZONTAL	VERTICAL NAVD88		
LOCATION COORDINATES N 1,066,287.0 E 601,563.0				ELEVATION TOP OF BORING 29.3					
ELEV	DEPTH	LEGEND	FIELD CLASSIFICATION OF MATERIALS (Description)	% REC	Sampl No.	RQD %	REMARKS	Blows/ 0.5 ft	N-Value
-7.7	37.0		SAND WITH CLAY (SP-SC), brown gray, fine <i>(continued)</i>						
			CLAYEY SAND (SC), dark gray, fine						
-12.7	42.0			100	13			3 3 5	8
			SAND (SP), gray, fine						
				60	14			17 17 23	40
			fine to medium						
				53	15			14 20 25	45
-22.7	52.0		CLAYEY SAND (SC), green gray, fine, with trace phosphate						
					80	16	-200: 21	1 2 1	3
			with trace shell		140	17		0 3 3	6
					133	18		2 2 2	4
					120	19		3 5 6	11
			light green gray		93	20	-200: 19	7 10 10	20

DRILLING LOG (Cont Sheet)				INSTALLATION			SHEET 3 OF 3 SHEETS		
				PROJECT Lake Okeechobee Component A Reservoir			COORDINATE SYSTEM State Plane		HORIZONTAL : VERTICAL NAVD88
LOCATION COORDINATES N 1,066,287.0 E 601,563.0				ELEVATION TOP OF BORING 29.3					
ELEV	DEPTH	LEGEND	FIELD CLASSIFICATION OF MATERIALS (Description)	% REC	Samp No.	RQD %	REMARKS	Blows/ 0.5 ft	N-Value
-50.7	80.0	[Hatched Legend]	CLAYEY SAND (SC), green gray, fine, with trace phosphate <i>(continued)</i>	120	21			6 8 15	23
BOTTOM OF BOREHOLE AT 80.0 ft									
NOTES: 1. N Value: Standard penetration resistance in blows/foot 2. NM: Nautral Moisture Content (ASTMD-2216) -200: Percent Fines (ASTM D-1140) LL: Liquid Limit (ASTM D-4318) PI: Plasticity Index (ASTM D-4318) PP: Pocket Penetrometer, Qu (TSF) NP: Non-plastic 3. Soils are classified in accordance with the Unified Soil Classification System (ASTM D-2487) 4. Upon completion, the borehole was grouted with cement-bentonite slurry 5. Boring performed using an automatic hammer to the boring termination depth. Automatic hammer values may be converted to equivalent safety hammer values by multiplying by 1.24. 6. WOH = Borehole advanced by weight of hammer. 7. ATD = Groundwater level depth at time of drilling.				Reading Depth Notes ATD 2.5		Date / Time 8/24/2023			

80

Boring Designation B-21

DRILLING LOG		DIVISION	INSTALLATION	SHEET 1 OF 2 SHEETS
1. PROJECT Lake Okeechobee Component A Reservoir Highlands County, Florida			9. COORDINATE SYSTEM State Plane	HORIZONTAL VERTICAL NAVD88
2. HOLE NUMBER B-21		LOCATION COORDINATES N 1,066,548.0 E 596,954.0		10. SIZE AND TYPE OF BIT 2-7/8" Drag Bit
3. DRILLING AGENCY Ardaman & Associates, Inc.			11. MANUFACTURER'S DESIGNATION OF DRILL CME-45	
4. NAME OF DRILLER Josh Tiller/Jack Santiago			12. TOTAL SAMPLES DISTURBED 13 UNDISTURBED 0	
5. DIRECTION OF BORING <input checked="" type="checkbox"/> VERTICAL <input type="checkbox"/> INCLINED		DEG FROM VERTICAL ---	BEARING	
6. THICKNESS OF OVERBURDEN			13. TOTAL NUMBER CORE BOXES 0	
7. DEPTH DRILLED INTO ROCK 0.0			14. ELEVATION GROUND WATER 40.2 8/28/23	
8. TOTAL DEPTH OF BORING 40.0			15. DATE BORING STARTED 8/28/23 COMPLETED 8/28/23	
			16. ELEVATION TOP OF BORING 42.7	
			17. TOTAL CORE RECOVERY FOR BORING N/A	
			18. SIGNATURE AND TITLE OF INSPECTOR Victor Steck Geotechnical Engineer	

ELEV	DEPTH	LEGEND	FIELD CLASSIFICATION OF MATERIALS (Description)	% REC	Sampl No.	ROD %	REMARKS	Blows/ 0.5 ft	N-Value
38.2	4.5		SAND WITH SILT (SP-SM), light gray, fine	100	1		Hand auger 0 - 4.5		
				100	2				
				100	3		-200: 6		
33.7	9.0		SAND (SP), light gray, fine	80	4			2	5
				73	5			3	8
				73	6			4	5
								2	
								2	
30.7	12.0		SAND WITH SILT (SP-SM), dark brown, fine very dark brown	87	7			2	4
								2	
								2	
			SAND WITH CLAY (SP-SC), gray, fine	67	8			7	9
			light gray					5	
								4	
				80	9		-200: 10	8	25
								10	
								15	
20.7	22.0		SILTY SAND (SM), light gray, fine						
				100	10		NM: 18, -200: 18, LL: NP, PI: NP	6	12
								6	
								6	
15.7	27.0		CLAYEY SAND (SC), light green gray, fine, with trace shell, trace phosphate	100	11			1	5
								2	
								3	
				100	12			4	19
								8	
								11	

DRILLING LOG (Cont Sheet)	INSTALLATION	SHEET 2 OF 2 SHEETS
PROJECT Lake Okeechobee Component A Reservoir	COORDINATE SYSTEM State Plane	HORIZONTAL : VERTICAL : NAVD88
LOCATION COORDINATES N 1,066,548.0 E 596,954.0	ELEVATION TOP OF BORING 42.7	

ELEV	DEPTH	LEGEND	FIELD CLASSIFICATION OF MATERIALS (Description)	% REC	Samp No.	ROD %	REMARKS	Blows/ 0.5 ft	N-Value
5.7	37.0	[Diagonal Hatching]	CLAYEY SAND (SC), light green gray, fine, with trace shell, trace phosphate (<i>continued</i>)						
		[Diagonal Hatching]	CLAY (CH), light green gray						
2.7	40.0	[Diagonal Hatching]		100	13			3 4 6	10

BOTTOM OF BOREHOLE AT 40.0 ft

Reading Depth Notes Date / Time
ATD 2.5 8/28/2023

NOTES:




1. N Value: Standard penetration resistance in blows/foot
2. NM: Nautral Moisture Content (ASTMD-2216)
-200: Percent Fines (ASTM D-1140)
LL: Liquid Limit (ASTM D-4318)
PI: Plasticity Index (ASTM D-4318)
PP: Pocket Penetrometer, Qu (TSF)
NP: Non-plastic
3. Soils are classified in accordance with the Unified Soil Classification System (ASTM D-2487)
4. Upon completion, the borehole was grouted with cement-bentonite slurry
5. Boring performed using an automatic hammer to the boring termination depth. Automatic hammer values may be converted to equivalent safety hammer values by multiplying by 1.24.
6. WOH = Borehole advanced by weight of hammer.
7. ATD = Groundwater level depth at time of drilling.

Boring Designation B-22

DRILLING LOG		DIVISION	INSTALLATION	SHEET 1 OF 2 SHEETS
1. PROJECT Lake Okeechobee Component A Reservoir Highlands County, Florida			9. COORDINATE SYSTEM State Plane	HORIZONTAL VERTICAL NAVD88
2. HOLE NUMBER B-22		LOCATION COORDINATES N 1,072,565.0 E 602,513.0		10. SIZE AND TYPE OF BIT 2-7/8" Drag Bit
3. DRILLING AGENCY Ardaman & Associates, Inc.			11. MANUFACTURER'S DESIGNATION OF DRILL CME-45	
4. NAME OF DRILLER Josh Tiller/Jack Santiago			12. TOTAL SAMPLES DISTURBED 13 UNDISTURBED 0	
5. DIRECTION OF BORING <input checked="" type="checkbox"/> VERTICAL <input type="checkbox"/> INCLINED			13. TOTAL NUMBER CORE BOXES 0	
6. THICKNESS OF OVERBURDEN			14. ELEVATION GROUND WATER 36.1 8/16/23	
7. DEPTH DRILLED INTO ROCK 0.0			15. DATE BORING STARTED 8/16/23 COMPLETED 8/16/23	
8. TOTAL DEPTH OF BORING 40.0			16. ELEVATION TOP OF BORING 37.5	
			17. TOTAL CORE RECOVERY FOR BORING N/A	
			18. SIGNATURE AND TITLE OF INSPECTOR Victor Steck Geotechnical Engineer	

ELEV	DEPTH	LEGEND	FIELD CLASSIFICATION OF MATERIALS (Description)	% REC	Samp No.	ROD %	REMARKS	Blows/ 0.5 ft	N-Value
			SAND (SP), gray, fine	100	1		Hand auger 0 - 3		
			light brown	100	2				
33.0	4.5			67	3			7 7 7	14
31.5	6.0		CLAYEY SAND (SC), light brown, fine	80	4		-200: 14	8 5	14
			SAND (SP), very light gray, fine	80	5			9 7	
28.5	9.0			60	6			8 12 4	20
			SAND WITH CLAY (SP-SC), light brown, fine	67	7			9 11	20
25.5	12.0							7 9 13	22
			SILTY SAND (SM), dark brown, fine				-200: 16		
				53	8			10 11 13	24
				53	9			10 10 12	22
15.5	22.0								
			SAND WITH CLAY (SP-SC), brown gray, fine						
				87	10			6 6 4	10
10.5	27.0								
			SANDY CLAY (CH), green gray				-200: 56		
				133	11			0 0 3	3
				133	12			0 1 2	3

DRILLING LOG (Cont Sheet)		INSTALLATION		SHEET 2 OF 2 SHEETS	
PROJECT Lake Okeechobee Component A Reservoir		COORDINATE SYSTEM State Plane		HORIZONTAL VERTICAL NAVD88	
LOCATION COORDINATES N 1,072,565.0 E 602,513.0		ELEVATION TOP OF BORING 37.5			

ELEV	DEPTH	LEGEND	FIELD CLASSIFICATION OF MATERIALS (Description)	% REC	Samp No.	RQD %	REMARKS	Blows/ 0.5 ft	N-Value
0.5	37.0		SANDY CLAY (CH), green gray (continued)				NM: 57, -200: 30, LL: 63, PI: 38		
			CLAYEY SAND (SC), dark green gray, fine, with trace phosphate					0	
-2.5	40.0			133	13			0	1

BOTTOM OF BOREHOLE AT 40.0 ft

Reading Depth Notes Date / Time
ATD 1.4 8/16/2023













NOTES:

1. N Value: Standard penetration resistance in blows/foot
2. NM: Nautral Moisture Content (ASTMD-2216)
-200: Percent Fines (ASTM D-1140)
LL: Liquid Limit (ASTM D-4318)
PI: Plasticity Index (ASTM D-4318)
PP: Pocket Penetrometer, Qu (TSF)
NP: Non-plastic
3. Soils are classified in accordance with the Unified Soil Classification System (ASTM D-2487)
4. Upon completion, the borehole was grouted with cement-bentonite slurry
5. Boring performed using an automatic hammer to the boring termination depth. Automatic hammer values may be converted to equivalent safety hammer values by multiplying by 1.24.
6. WOH = Borehole advanced by weight of hammer.
7. ATD = Groundwater level depth at time of drilling.

Boring Designation B-23

DRILLING LOG		DIVISION	INSTALLATION	SHEET 1 OF 2 SHEETS
1. PROJECT Lake Okeechobee Component A Reservoir Highlands County, Florida		9. COORDINATE SYSTEM State Plane		HORIZONTAL VERTICAL NAVD88
2. HOLE NUMBER B-23		LOCATION COORDINATES N 1,075,898.0 E 602,324.0		10. SIZE AND TYPE OF BIT 3-7/8" Tricone
3. DRILLING AGENCY Ardaman & Associates, Inc.		11. MANUFACTURER'S DESIGNATION OF DRILL CME-45		12. TOTAL SAMPLES DISTURBED 19 UNDISTURBED 1
4. NAME OF DRILLER Josh Tiller/Jack Santiago		13. TOTAL NUMBER CORE BOXES 0		14. ELEVATION GROUND WATER 33.8 8/17/23
5. DIRECTION OF BORING <input checked="" type="checkbox"/> VERTICAL <input type="checkbox"/> INCLINED		DEG FROM VERTICAL ---	BEARING	15. DATE BORING STARTED 8/17/23 COMPLETED 8/17/23
6. THICKNESS OF OVERBURDEN		16. ELEVATION TOP OF BORING 34.4		17. TOTAL CORE RECOVERY FOR BORING N/A
7. DEPTH DRILLED INTO ROCK 0.0		18. SIGNATURE AND TITLE OF INSPECTOR Victor Steck Geotechnical Engineer		
8. TOTAL DEPTH OF BORING 65.0				

ELEV	DEPTH	LEGEND	FIELD CLASSIFICATION OF MATERIALS (Description)	% REC	Samp No.	ROD %	REMARKS	Blows/ 0.5 ft	N-Value
			SAND WITH SILT (SP-SM), light gray, fine	100	1		Hand auger 0 - 1.5		
			light brown	80	2		-200: 6	9	
29.9	4.5			60	3			10	22
			CLAYEY SAND (SC), light brown, fine	80	4			7	
26.9	7.5			100	5			9	19
			SAND (SP), light gray, fine	80	6			10	
				80	7			6	21
22.4	12.0							10	
			SAND WITH CLAY (SP-SC), gray, fine	40	8			11	
			brown gray					9	36
				80	9			18	
								18	
				87	10		-200: 7	13	
								6	
				67	11			7	13
								6	
								10	34
								14	
								20	
				53	12			7	25
								8	
								17	

DRILLING LOG (Cont Sheet)				INSTALLATION		SHEET 2 OF 2 SHEETS			
PROJECT				COORDINATE SYSTEM		HORIZONTAL VERTICAL			
Lake Okeechobee Component A Reservoir				State Plane		NAVD88			
LOCATION COORDINATES				ELEVATION TOP OF BORING					
N 1,075,898.0 E 602,324.0				34.4					
ELEV	DEPTH	LEGEND	FIELD CLASSIFICATION OF MATERIALS (Description)	% REC	Sampl No.	RQD %	REMARKS	Blows/ 0.5 ft	N-Value
-2.6	37.0		SAND WITH CLAY (SP-SC), gray, fine (continued)						
			SAND (SP), gray, fine to medium	53	13		10% loss of circulation	5 7 4	11
			brown gray, fine						
				120	14		-200: 4	2 1 0	1
-12.6	47.0		CLAYEY SAND (SC), green gray, fine, mostly shell, trace phosphate	60	15		100% loss of circulation	11 12 10	22
			with trace shell						
				87	16			4 4 7	11
-22.6	57.0		SANDY CLAY (CH), green gray				-200: 55	3 4 5	9
-25.6	60.0			133	17				
			CLAY WITH SAND (CH), green gray	100	SH1		NM: 56, -200: 71, LL: 89, PI: 53		
				27	18			3 4 5	9
-30.6	65.0			133	19			7 8	15

BOTTOM OF BOREHOLE AT 65.0 ft

NOTES:

- N Value: Standard penetration resistance in blows/foot
- NM: Nastral Moisture Content (ASTMD-2216)
-200: Percent Fines (ASTM D-1140)
LL: Liquid Limit (ASTM D-4318)
PI: Plasticity Index (ASTM D-4318)
PP: Pocket Penetrometer, Qu (TSF)
NP: Non-plastic
- Soils are classified in accordance with the Unified Soil Classification System (ASTM D-2487)
- Upon completion, the borehole was grouted with cement-bentonite slurry
- Boring performed using an automatic hammer to the boring termination depth. Automatic hammer values may be converted to equivalent safety hammer values by multiplying by 1.24.
- WOH = Borehole advanced by weight of hammer.
- ATD = Groundwater level depth at time of drilling

Reading Depth Notes
ATD 0.6





Date / Time
8/17/2023

Boring Designation B-24

DRILLING LOG		DIVISION	INSTALLATION	SHEET 1 OF 2 SHEETS
1. PROJECT Lake Okeechobee Component A Reservoir Highlands County, Florida			9. COORDINATE SYSTEM State Plane	HORIZONTAL VERTICAL NAVD88
2. HOLE NUMBER B-24		LOCATION COORDINATES N 1,073,700.0 E 609,947.0		10. SIZE AND TYPE OF BIT 2-7/8" Drag Bit
3. DRILLING AGENCY Ardaman & Associates, Inc.			11. MANUFACTURER'S DESIGNATION OF DRILL CME-45	
4. NAME OF DRILLER Josh Tiller/Jack Santiago			12. TOTAL SAMPLES DISTURBED 14 UNDISTURBED 0	
5. DIRECTION OF BORING <input checked="" type="checkbox"/> VERTICAL <input type="checkbox"/> INCLINED			13. TOTAL NUMBER CORE BOXES 0	
DEG FROM VERTICAL --- BEARING			14. ELEVATION GROUND WATER 34.3 8/18/23	
6. THICKNESS OF OVERBURDEN			15. DATE BORING STARTED 8/18/23 COMPLETED 8/18/23	
7. DEPTH DRILLED INTO ROCK 0.0			16. ELEVATION TOP OF BORING 34.8	
8. TOTAL DEPTH OF BORING 45.0			17. TOTAL CORE RECOVERY FOR BORING N/A	
18. SIGNATURE AND TITLE OF INSPECTOR Victor Steck Geotechnical Engineer				

ELEV	DEPTH	LEGEND	FIELD CLASSIFICATION OF MATERIALS (Description)	% REC	Samp No.	ROD %	REMARKS	Blows/ 0.5 ft	N-Value
33.3	1.5		SAND (SP), gray brown, fine	100	1		Hand auger 0 - 1.5		
			SAND WITH SILT (SP-SM), dark brown, fine, with trace organics	47	2		NM: 33, -200: 7, OC: 4	5	8
				107	3			3	4
				93	4			2	5
			with no organics	80	5			2	5
				80	6			3	9
								3	
25.8	9.0		SAND (SP), light brown, fine	100	7		-200: 13	4	9
			SILTY SAND (SM), light brown, fine					4	
				67	8			3	7
17.8	17.0		SAND (SP), light gray, fine				-200: 16		
				60	9			6	11
								6	
12.8	22.0		SAND WITH CLAY (SP-SC), brown gray, fine				-200: 16		
				53	10			8	28
								11	
7.8	27.0		CLAYEY SAND (SC), brown gray, fine				-200: 16		
				87	11			6	9
								6	
2.8	32.0		SAND WITH CLAY (SP-SC), brown gray, fine						
				67	12			7	36
								15	
							21		

DRILLING LOG (Cont Sheet)		INSTALLATION		SHEET 2 OF 2 SHEETS	
PROJECT Lake Okeechobee Component A Reservoir		COORDINATE SYSTEM State Plane		HORIZONTAL VERTICAL NAVD88	
LOCATION COORDINATES N 1,073,700.0 E 609,947.0		ELEVATION TOP OF BORING 34.8			

ELEV	DEPTH	LEGEND	FIELD CLASSIFICATION OF MATERIALS (Description)	% REC	Samp No.	ROD %	REMARKS	Blows/ 0.5 ft	N-Value
-2.2	37.0		SAND WITH CLAY (SP-SC), brown gray, fine <i>(continued)</i>				NM: 70, -200: 58, LL: 88, PI: 65		
			SANDY CLAY (CH), dark green gray	133	13			0	1
-7.2	42.0		CLAYEY SAND (SC), light green gray, fine, with trace shell, trace phosphate					1	
-10.2	45.0			107	14		2	5	

BOTTOM OF BOREHOLE AT 45.0 ft

NOTES:

- N Value: Standard penetration resistance in blows/foot
- NM: Nautral Moisture Content (ASTMD-2216)
-200: Percent Fines (ASTM D-1140)
LL: Liquid Limit (ASTM D-4318)
PI: Plasticity Index (ASTM D-4318)
PP: Pocket Penetrometer, Qu (TSF)
NP: Non-plastic
- Soils are classified in accordance with the Unified Soil Classification System (ASTM D-2487)
- Upon completion, the borehole was grouted with cement-bentonite slurry
- Boring performed using an automatic hammer to the boring termination depth. Automatic hammer values may be converted to equivalent safety hammer values by multiplying by 1.24.
- WOH = Borehole advanced by weight of hammer.
- ATD = Groundwater level depth at time of drilling.

Reading Depth Notes

ATD 0.5

Date / Time

8/18/2023

DRILLING LOG (Cont Sheet)		INSTALLATION		SHEET 2 OF 2 SHEETS	
PROJECT Lake Okeechobee Component A Reservoir		COORDINATE SYSTEM State Plane		HORIZONTAL : VERTICAL : NAVD88	
LOCATION COORDINATES N 1,067,885.0 E 617,191.0		ELEVATION TOP OF BORING 34.8			

ELEV	DEPTH	LEGEND	FIELD CLASSIFICATION OF MATERIALS (Description)	% REC	Samp No.	RQD %	REMARKS	Blows/ 0.5 ft	N-Value
			SAND WITH CLAY (SP-SC), gray, fine (continued)	53	12				WOH
					133	13			WOH
			gray, mostly shell, with trace phosphate						
-10.2	45.0			93	14			6 9 10	19

BOTTOM OF BOREHOLE AT 45.0 ft

NOTES:

- N Value: Standard penetration resistance in blows/foot
- NM: Nautral Moisture Content (ASTMD-2216)
-200: Percent Fines (ASTM D-1140)
LL: Liquid Limit (ASTM D-4318)
PI: Plasticity Index (ASTM D-4318)
PP: Pocket Penetrometer, Qu (TSF)
NP: Non-plastic
- Soils are classified in accordance with the Unified Soil Classification System (ASTM D-2487)
- Upon completion, the borehole was grouted with cement-bentonite slurry
- Boring performed using an automatic hammer to the boring termination depth. Automatic hammer values may be converted to equivalent safety hammer values by multiplying by 1.24.
- WOH = Borehole advanced by weight of hammer.
- ATD = Groundwater level depth at time of drilling.

Reading Depth Notes

ATD 0.2

Date / Time

8/23/2023

Boring Designation PZ-01

DRILLING LOG	DIVISION	INSTALLATION	SHEET 1 OF 2 SHEETS
1. PROJECT Lake Okeechobee Component A Reservoir Highlands County, Florida		9. COORDINATE SYSTEM State Plane	HORIZONTAL : VERTICAL NAVD88
2. HOLE NUMBER PZ-01		10. SIZE AND TYPE OF BIT 2-7/8" Drag Bit	
3. DRILLING AGENCY Ardaman & Associates, Inc.		11. MANUFACTURER'S DESIGNATION OF DRILL CME-45	
4. NAME OF DRILLER Josh Tiller/Jack Santiago		12. TOTAL SAMPLES DISTURBED : 20 UNDISTURBED : 0	
5. DIRECTION OF BORING <input checked="" type="checkbox"/> VERTICAL <input type="checkbox"/> INCLINED		13. TOTAL NUMBER CORE BOXES 0	
6. THICKNESS OF OVERBURDEN		14. ELEVATION GROUND WATER 35.2 5/19/23	
7. DEPTH DRILLED INTO ROCK 0.0		15. DATE BORING STARTED : 5/19/23 COMPLETED : 5/19/23	
8. TOTAL DEPTH OF BORING 75.0		16. ELEVATION TOP OF BORING 40.7	
		17. TOTAL CORE RECOVERY FOR BORING N/A	
		18. SIGNATURE AND TITLE OF INSPECTOR Victor Steck Geotechnical Engineer	

ELEV	DEPTH	LEGEND	FIELD CLASSIFICATION OF MATERIALS (Description)	% REC	Samp No.	RQD %	REMARKS	Blows/ 0.5 ft	N-Value
			SAND (SP), light gray, fine	100	1		Hand auger 0 - 4.5		
37.7	3.0		brown	100	2				
36.2	4.5		SAND WITH SILT (SP-SM), dark brown, fine	100	3				
34.7	6.0		SAND WITH CLAY (SP-SC), light gray, fine	67	4			5 4	10
			SAND (SP), light gray, fine	87	5			3 6	9
				73	6			2 3 3	6
				100	7			3 5 7	12
28.7	12.0		SAND WITH SILT (SP-SM), brown gray, fine				Hard drilling 12 - 12.5		
				73	8				8 9 11
							-200: 8		
				87	9				6 12 16
							Soft drilling 25 - 33.5		
				100	10				3 5 3
13.7	27.0		CLAYEY SAND (SC), green gray, fine, with few shell				NM: 31, -200: 18, LL: 35, PI: 15		
				100	11				0 0 1 1
			light gray, with trace shell, trace phosphate						
				100	12			0 1 1	2

DRILLING LOG (Cont Sheet)				INSTALLATION			SHEET 2 OF 2 SHEETS			
PROJECT				COORDINATE SYSTEM		HORIZONTAL	VERTICAL			
Lake Okeechobee Component A Reservoir				State Plane			NAVD88			
LOCATION COORDINATES				ELEVATION TOP OF BORING						
N 1,076,776.0 E 626,031.0				40.7						
ELEV	DEPTH	LEGEND	FIELD CLASSIFICATION OF MATERIALS (Description)	% REC	Sampl No.	RQD %	REMARKS	Blows/ 0.5 ft	N-Value	
			CLAYEY SAND (SC), green gray, fine, with few shell (continued)							
					100	13			0 0 0	WOH
								Hard drilling 41.5 - 43.5		
					87	14			4 3 3	6
				green gray	100	15			3 1 1	2
-11.3	52.0		SANDY CLAY (CH), green gray							
					100	16		Soft drilling 55 - 58.5	0 2 1	3
				dark green gray				PP: 1.25	2 2 1	3
-21.3	62.0		SILTY SAND (SM), green gray, fine, with trace phosphate							
					100	18		NM: 29, -200: 20, LL: NP, PI: NP	2 3 3	6
-26.3	67.0		CLAYEY SAND (SC), green gray, fine, with trace phosphate, trace shell							
					87	19			2 3 3	6
				with little shell					6 4 2	6
-34.3	75.0			100	20					
BOTTOM OF BOREHOLE AT 75.0 ft										
						Reading Depth Notes		Date / Time		
						ATD 5.5		5/19/2023		

Boring Designation PZ-02

DRILLING LOG		DIVISION	INSTALLATION	SHEET 1 OF 2 SHEETS
1. PROJECT Lake Okeechobee Component A Reservoir Highlands County, Florida			9. COORDINATE SYSTEM State Plane	HORIZONTAL VERTICAL NAVD88
2. HOLE NUMBER PZ-02		LOCATION COORDINATES N 1,058,672.0 E 629,311.0		10. SIZE AND TYPE OF BIT 2-7/8" Drag Bit
3. DRILLING AGENCY Ardaman & Associates, Inc.			11. MANUFACTURER'S DESIGNATION OF DRILL CME-45	
4. NAME OF DRILLER Josh Tiller/Jack Santiago			12. TOTAL SAMPLES DISTURBED 16 UNDISTURBED 0	
5. DIRECTION OF BORING <input checked="" type="checkbox"/> VERTICAL <input type="checkbox"/> INCLINED		DEG FROM VERTICAL ---	BEARING	
6. THICKNESS OF OVERBURDEN			13. TOTAL NUMBER CORE BOXES 0	
7. DEPTH DRILLED INTO ROCK 0.0			14. ELEVATION GROUND WATER 27.7 3/25/23	
8. TOTAL DEPTH OF BORING 55.0			15. DATE BORING STARTED 5/25/23 COMPLETED 5/25/23	
			16. ELEVATION TOP OF BORING 30.7	
			17. TOTAL CORE RECOVERY FOR BORING N/A	
			18. SIGNATURE AND TITLE OF INSPECTOR Victor Steck Geotechnical Engineer	

ELEV	DEPTH	LEGEND	FIELD CLASSIFICATION OF MATERIALS (Description)	% REC	Samp No.	ROD %	REMARKS	Blows/ 0.5 ft	N-Value
			SAND WITH SILT (SP-SM), light brown, fine	100	1		Hand auger 0 - 4.5		
27.7	3.0			100	2		-200: 9		
			SAND (SP), light gray, fine	100	3				
				120	4			4	11
				53	5			5	
23.2	7.5							4	8
			SAND WITH SILT (SP-SM), dark brown, fine	73	6			4	9
				113	7			2	
								5	
								3	11
								6	
				113	8			4	5
								3	
								2	
			gray						
				133	9		-200: 5	2	5
8.7	22.0							2	
			CLAYEY SAND (SC), green gray, fine, mostly shell	73	10			3	5
								2	
								3	
3.7	27.0		SILTY SAND (SM), light gray, fine, with trace shell	133	11			0	1
								0	
								1	
-1.3	32.0		CLAY (CH), light green gray	107	12		PP: 0.25, NM: 71, -200: 93, LL: 108, PI: 78	1	2
								1	
								1	

DRILLING LOG (Cont Sheet)		INSTALLATION		SHEET 2 OF 2 SHEETS	
PROJECT Lake Okeechobee Component A Reservoir		COORDINATE SYSTEM State Plane		HORIZONTAL VERTICAL NAVD88	
LOCATION COORDINATES N 1,058,672.0 E 629,311.0		ELEVATION TOP OF BORING 30.7			

ELEV	DEPTH	LEGEND	FIELD CLASSIFICATION OF MATERIALS (Description)	% REC	Samp No.	ROD %	REMARKS	Blows/ 0.5 ft	N-Value
-6.3	37.0		CLAY (CH), light green gray (continued)						
			CLAYEY SAND (SC), light green gray, fine, with some shell, trace phosphate	120	13			2 3 4	7
-11.3	42.0		SILTY SAND (SM), light gray, fine, with some shell	53	14			2 2 3	5
-16.3	47.0		CLAYEY SAND (SC), dark green gray, fine, with trace shell, trace phosphate	100	15		-200: 32	1 2 3	5
			green gray				PP: 0.5	2 2 4	6
-24.3	55.0			133	16				

BOTTOM OF BOREHOLE AT 55.0 ft

NOTES:

- N Value: Standard penetration resistance in blows/foot
- NM: Nautral Moisture Content (ASTMD-2216)
-200: Percent Fines (ASTM D-1140)
LL: Liquid Limit (ASTM D-4318)
PI: Plasticity Index (ASTM D-4318)
PP: Pocket Penetrometer, Qu (TSF)
NP: Non-plastic
- Soils are classified in accordance with the Unified Soil Classification System (ASTM D-2487)
- Upon completion, the borehole was grouted with cement-bentonite slurry
- Boring performed using an automatic hammer to the boring termination depth. Automatic hammer values may be converted to equivalent safety hammer values by multiplying by 1.24.
- WOH = Borehole advanced by weight of hammer.
- ATD = Groundwater level depth at time of drilling.

Reading Depth Notes

ATD 3

Date / Time

3/25/2023

Boring Designation PZ-03

DRILLING LOG		DIVISION	INSTALLATION	SHEET 1 OF 2 SHEETS
1. PROJECT Lake Okeechobee Component A Reservoir Highlands County, Florida			9. COORDINATE SYSTEM State Plane	HORIZONTAL VERTICAL NAVD88
2. HOLE NUMBER PZ-03		LOCATION COORDINATES N 1,075,658.0 E 607,941.0		10. SIZE AND TYPE OF BIT 2-7/8" Drag Bit
3. DRILLING AGENCY Ardaman & Associates, Inc.			11. MANUFACTURER'S DESIGNATION OF DRILL CME-45	
4. NAME OF DRILLER Josh Tiller/Jack Santiago			12. TOTAL SAMPLES DISTURBED 16 UNDISTURBED 0	
5. DIRECTION OF BORING <input checked="" type="checkbox"/> VERTICAL <input type="checkbox"/> INCLINED		DEG FROM VERTICAL	BEARING	
6. THICKNESS OF OVERBURDEN			13. TOTAL NUMBER CORE BOXES 0	
7. DEPTH DRILLED INTO ROCK 0.0			14. ELEVATION GROUND WATER 31.4 5/30/23	
8. TOTAL DEPTH OF BORING 55.0			15. DATE BORING STARTED 5/26/23 COMPLETED 5/26/23	
			16. ELEVATION TOP OF BORING 34.4	
			17. TOTAL CORE RECOVERY FOR BORING N/A	
			18. SIGNATURE AND TITLE OF INSPECTOR Victor Steck Geotechnical Engineer	

ELEV	DEPTH	LEGEND	FIELD CLASSIFICATION OF MATERIALS (Description)	% REC	Samp No.	ROD %	REMARKS	Blows/ 0.5 ft	N-Value
29.9	4.5		SAND (SP), light gray, fine	100	1		Hand auger 0 - 4.5		
				100	2				
				100	3				
28.4	6.0		SAND WITH CLAY (SP-SC), gray, fine	73	4		-200: 20	5	9
								4	
								3	
				100	5			5	12
								7	
								1	
25.4	9.0		CLAYEY SAND (SC), gray, fine	80	6			3	8
								5	
							6		
22.4	12.0		SAND (SP), light gray, fine	67	7			8	14
								6	
							8		
			SAND WITH SILT (SP-SM), brown gray, fine					6	
				80	8			9	9
								5	
							4		
								2	
				67	9			2	4
								2	
							2		
								4	
				73	10		-200: 11	3	5
								2	
7.4	27.0		SANDY CLAY (CH), green gray, with some shell						
				127	11			2	2
								1	
							1		
			with trace shell						
				113	12			0	2
								1	
							1		

DRILLING LOG (Cont Sheet)		INSTALLATION		SHEET 2 OF 2 SHEETS					
PROJECT		COORDINATE SYSTEM		HORIZONTAL VERTICAL					
Lake Okeechobee Component A Reservoir		State Plane		NAVD88					
LOCATION COORDINATES		ELEVATION TOP OF BORING							
N 1,075,658.0 E 607,941.0		34.4							
ELEV	DEPTH	LEGEND	FIELD CLASSIFICATION OF MATERIALS (Description)	% REC	Samp No.	ROD %	REMARKS	Blows/ 0.5 ft	N-Value
-2.6	37.0		SANDY CLAY (CH), green gray, with some shell (continued)						
			CLAYEY SAND (SC), green gray, fine, with some shell	100	13			0 1 3	4
-7.6	42.0		SILTY SAND (SM), light gray, fine, with few cemented fragments, trace shell	80	14		-200: 34	5 8 8	16
-12.6	47.0		CLAYEY SAND (SC), green gray, fine, with few shell, trace phosphate	87	15		-200: 30	4 5 7	12
-20.6	55.0			87	16			3 4 7	11

BOTTOM OF BOREHOLE AT 55.0 ft

NOTES:

- N Value: Standard penetration resistance in blows/foot
- NM: Nautral Moisture Content (ASTMD-2216)
-200: Percent Fines (ASTM D-1140)
LL: Liquid Limit (ASTM D-4318)
PI: Plasticity Index (ASTM D-4318)
PP: Pocket Penetrometer, Qu (TSF)
NP: Non-plastic
- Soils are classified in accordance with the Unified Soil Classification System (ASTM D-2487)
- Upon completion, the borehole was grouted with cement-bentonite slurry
- Boring performed using an automatic hammer to the boring termination depth. Automatic hammer values may be converted to equivalent safety hammer values by multiplying by 1.24.
- WOH = Borehole advanced by weight of hammer.
- ATD = Groundwater level depth at time of drilling.

Reading Depth Notes


AD 3

Date / Time

5/30/2023

DRILLING LOG (Cont Sheet)				INSTALLATION		SHEET 2 OF 3 SHEETS			
PROJECT Lake Okeechobee Component A Reservoir				COORDINATE SYSTEM State Plane		HORIZONTAL VERTICAL NAVD88			
LOCATION COORDINATES N 1,095,820.0 E 609,455.0				ELEVATION TOP OF BORING 44.7					
ELEV	DEPTH	LEGEND	FIELD CLASSIFICATION OF MATERIALS (Description)	% REC	Samp No.	ROD %	REMARKS	Blows/ 0.5 ft	N-Value
7.7	37.0		SILTY SAND (SM), dark brown, fine (continued)						
			CLAYEY SAND (SC), dark green gray, fine	100	13			1 1 1	2
			green gray, with few cemented nodules, trace shell	100	14		-200: 46	0 0 2	2
-2.3	47.0		SANDY CLAY (CH), green gray, with some shell	100	15			4 3 4	7
-7.3	52.0		CLAYEY SAND (SC), light green gray, fine, with some shell	100	16			4 4 3	7
			brown gray, with no shell	87	17			2 3 4	7
			light green gray, with trace shell, trace phosphate	100	18			0 2 2	4
				100	19			1 2 2	4
-27.3	72.0		SANDY CLAY (CL), green gray, with trace shell, trace phosphate	100	20		PP: 0.75	3 4 4	8
-32.3	77.0								

DRILLING LOG (Cont Sheet)		INSTALLATION		SHEET 3 OF 3 SHEETS	
PROJECT Lake Okeechobee Component A Reservoir		COORDINATE SYSTEM State Plane		HORIZONTAL VERTICAL NAVD88	
LOCATION COORDINATES N 1,095,820.0 E 609,455.0		ELEVATION TOP OF BORING 44.7			

ELEV	DEPTH	LEGEND	FIELD CLASSIFICATION OF MATERIALS (Description)	% REC	Samp No.	RQD %	REMARKS	Blows/ 0.5 ft	N-Value
-35.3	80.0		CLAYEY SAND (SC), light green gray, fine, with trace shell, trace phoshate (continued)	100	21			2 2 3	5

BOTTOM OF BOREHOLE AT 80.0 ft

NOTES:

1. N Value: Standard penetration resistance in blows/foot
2. NM: Nautral Moisture Content (ASTMD-2216)
-200: Percent Fines (ASTM D-1140)
LL: Liquid Limit (ASTM D-4318)
PI: Plasticity Index (ASTM D-4318)
PP: Pocket Penetrometer, Qu (TSF)
NP: Non-plastic
3. Soils are classified in accordance with the Unified Soil Classification System (ASTM D-2487)
4. Upon completion, the borehole was grouted with cement-bentonite slurry
5. Boring performed using an automatic hammer to the boring termination depth. Automatic hammer values may be converted to equivalent safety hammer values by multiplying by 1.24.
6. WOH = Borehole advanced by weight of hammer.
7. ATD = Groundwater level depth at time of drilling.

Reading Depth		Notes	Date / Time
ATD	3.1		6/8/2023
AD	3.5		6/8/2023

80

Boring Designation PZ-05

DRILLING LOG		DIVISION	INSTALLATION	SHEET 1 OF 2 SHEETS
1. PROJECT Lake Okeechobee Component A Reservoir Highlands County, Florida			9. COORDINATE SYSTEM State Plane	HORIZONTAL VERTICAL NAVD88
2. HOLE NUMBER PZ-05		LOCATION COORDINATES N 1,110,676.0 E 600,398.0		10. SIZE AND TYPE OF BIT 2-7/8" Drag Bit
3. DRILLING AGENCY Ardaman & Associates, Inc.			11. MANUFACTURER'S DESIGNATION OF DRILL CME-45	
4. NAME OF DRILLER Josh Tiller/Jack Santiago			12. TOTAL SAMPLES DISTURBED 16 UNDISTURBED 0	
5. DIRECTION OF BORING <input checked="" type="checkbox"/> VERTICAL <input type="checkbox"/> INCLINED			13. TOTAL NUMBER CORE BOXES 0	
DEG FROM VERTICAL --- BEARING			14. ELEVATION GROUND WATER 36.5 6/8/23	
6. THICKNESS OF OVERBURDEN			15. DATE BORING STARTED 6/8/23 COMPLETED 6/9/23	
7. DEPTH DRILLED INTO ROCK 0.0			16. ELEVATION TOP OF BORING 40.4	
8. TOTAL DEPTH OF BORING 55.0			17. TOTAL CORE RECOVERY FOR BORING N/A	
18. SIGNATURE AND TITLE OF INSPECTOR Victor Steck Geotechnical Engineer				

ELEV	DEPTH	LEGEND	FIELD CLASSIFICATION OF MATERIALS (Description)	% REC	Samp No.	RQD %	REMARKS	Blows/ 0.5 ft	N-Value
38.9	1.5		SAND (SP), light brown, fine	100	1		Hand auger 0 - 4.5		
34.4	6.0		FINE SAND WITH CLAY (SP-SC), orange brown, fine	100	2		1.5 - 6' FILL		
				100	3				
				60	4			2	
								3	6
32.9	7.5		SAND (SP), light brown, fine	80	5		4	7	
31.4	9.0		FINE SAND WITH CLAY (SP-SC), brown gray, fine	73	6		3	9	
							4		
							5		
28.4	12.0		SAND (SP), light gray, fine	87	7		4	13	
							6		
							7		
							4		
							5	11	
							6		
18.4	22.0		FINE SAND WITH CLAY (SP-SC), light brown, fine	53	8		-200: 10		
13.4	27.0		SAND (SP), gray, fine to medium	100	9		-200: 8		
8.4	32.0		CLAYEY SAND (SC), green gray, fine, with trace shell	67	10				
8.4	32.0		SANDY CLAY (CH), gray, with trace phosphate	100	11				
8.4	32.0		SANDY CLAY (CH), gray, with trace phosphate	100	12				

DRILLING LOG (Cont Sheet)	INSTALLATION	SHEET 2 OF 2 SHEETS
PROJECT Lake Okeechobee Component A Reservoir	COORDINATE SYSTEM State Plane	HORIZONTAL : VERTICAL : NAVD88
LOCATION COORDINATES N 1,110,676.0 E 600,398.0	ELEVATION TOP OF BORING 40.4	

ELEV	DEPTH	LEGEND	FIELD CLASSIFICATION OF MATERIALS (Description)	% REC	Samp No.	ROD %	REMARKS	Blows/ 0.5 ft	N-Value
		[Diagonal Hatching]	SANDY CLAY (CH), gray, with trace phosphate <i>(continued)</i> with trace shell						
				100	13			1 2 2	4
-1.6	42.0								
		[Diagonal Hatching]	CLAYEY SAND (SC), light gray, fine, with trace phosphate with trace shell						
				100	14			1 1 2	3
				100	15		-200: 22	6 6 6	12
			gray						
-14.6	55.0			100	16			2 1 2	3

BOTTOM OF BOREHOLE AT 55.0 ft

NOTES:

1. N Value: Standard penetration resistance in blows/foot
2. NM: Nautral Moisture Content (ASTMD-2216)
-200: Percent Fines (ASTM D-1140)
LL: Liquid Limit (ASTM D-4318)
PI: Plasticity Index (ASTM D-4318)
PP: Pocket Penetrometer, Qu (TSF)
NP: Non-plastic
3. Soils are classified in accordance with the Unified Soil Classification System (ASTM D-2487)
4. Upon completion, the borehole was grouted with cement-bentonite slurry
5. Boring performed using an automatic hammer to the boring termination depth. Automatic hammer values may be converted to equivalent safety hammer values by multiplying by 1.24.
6. WOH = Borehole advanced by weight of hammer.
7. ATD = Groundwater level depth at time of drilling.

Reading Depth Notes

ATD	3.9
24	3.8

Date / Time

6/8/2023
6/9/2023

Boring Designation PZ-06

DRILLING LOG	DIVISION	INSTALLATION	SHEET 1 OF 2 SHEETS
1. PROJECT Lake Okeechobee Component A Reservoir Highlands County, Florida		9. COORDINATE SYSTEM State Plane	HORIZONTAL : VERTICAL NAVD88
2. HOLE NUMBER PZ-06		10. SIZE AND TYPE OF BIT 3-7/8" Tricone	
3. DRILLING AGENCY Ardaman & Associates, Inc.		11. MANUFACTURER'S DESIGNATION OF DRILL CME-45	
4. NAME OF DRILLER Josh Tiller/Jack Santiago		12. TOTAL SAMPLES DISTURBED : 15 UNDISTURBED : 1	
5. DIRECTION OF BORING <input checked="" type="checkbox"/> VERTICAL <input type="checkbox"/> INCLINED		13. TOTAL NUMBER CORE BOXES 0	
6. THICKNESS OF OVERBURDEN		14. ELEVATION GROUND WATER 27.1 8/15/23	
7. DEPTH DRILLED INTO ROCK 0.0		15. DATE BORING STARTED : 8/15/23 COMPLETED : 8/15/23	
8. TOTAL DEPTH OF BORING 50.0		16. ELEVATION TOP OF BORING 28.3	
		17. TOTAL CORE RECOVERY FOR BORING N/A	
		18. SIGNATURE AND TITLE OF INSPECTOR Victor Steck Geotechnical Engineer	

ELEV	DEPTH	LEGEND	FIELD CLASSIFICATION OF MATERIALS (Description)	% REC	Samp No.	RCD %	REMARKS	Blows/ 0.5 ft	N-Value
26.8	1.5		SAND WITH SILT (SP-SM), dark gray, fine	100	1		Hand auger 0 - 3		
25.3	3.0		SAND (SP), gray, fine	100	2				
22.3	6.0		SAND WITH SILT (SP-SM), dark brown, fine	67	3		-200: 12	1	4
				80	4			2	
				93	5			4	
				60	6			5	
			SAND (SP), brown gray, fine	73	7		-200: 4	5	11
				53	8			6	
				60	9			5	
				53	10			5	
				60	9			5	
				53	10			6	
1.3	27.0		SILTY SAND (SM), dark green gray, fine	67	11		NM: 42, -200: 26, LL: 43, PI: 14	5	3
-3.7	32.0		CLAYEY SAND (SC), dark green gray, fine	100	SH12			2	
				107	13			1	
								0	WOH

DRILLING LOG (Cont Sheet)		INSTALLATION		SHEET 2 OF 2 SHEETS	
PROJECT Lake Okeechobee Component A Reservoir		COORDINATE SYSTEM State Plane		HORIZONTAL VERTICAL NAVD88	
LOCATION COORDINATES N 1,065,260.0 E 607,193.0		ELEVATION TOP OF BORING 28.3			

ELEV	DEPTH	LEGEND	FIELD CLASSIFICATION OF MATERIALS (Description)	% REC	Samp No.	RQD %	REMARKS	Blows/ 0.5 ft	N-Value	
			CLAYEY SAND (SC), dark green gray, fine <i>(continued)</i>				NM: 26, -200: 23, LL: 37, PI:17			
					107	14			2 3 6	9
					0	15			7 4 3	7
			green gray, with trace shell, trace phosphate							
-21.7	50.0			107	16			6 6 11	17	

BOTTOM OF BOREHOLE AT 50.0 ft

NOTES:

- N Value: Standard penetration resistance in blows/foot
- NM: Nautral Moisture Content (ASTMD-2216)
-200: Percent Fines (ASTM D-1140)
LL: Liquid Limit (ASTM D-4318)
PI: Plasticity Index (ASTM D-4318)
PP: Pocket Penetrometer, Qu (TSF)
NP: Non-plastic
- Soils are classified in accordance with the Unified Soil Classification System (ASTM D-2487)
- Upon completion, the borehole was grouted with cement-bentonite slurry
- Boring performed using an automatic hammer to the boring termination depth. Automatic hammer values may be converted to equivalent safety hammer values by multiplying by 1.24.
- WOH = Borehole advanced by weight of hammer.
- ATD = Groundwater level depth at time of drilling.

Reading Depth Notes

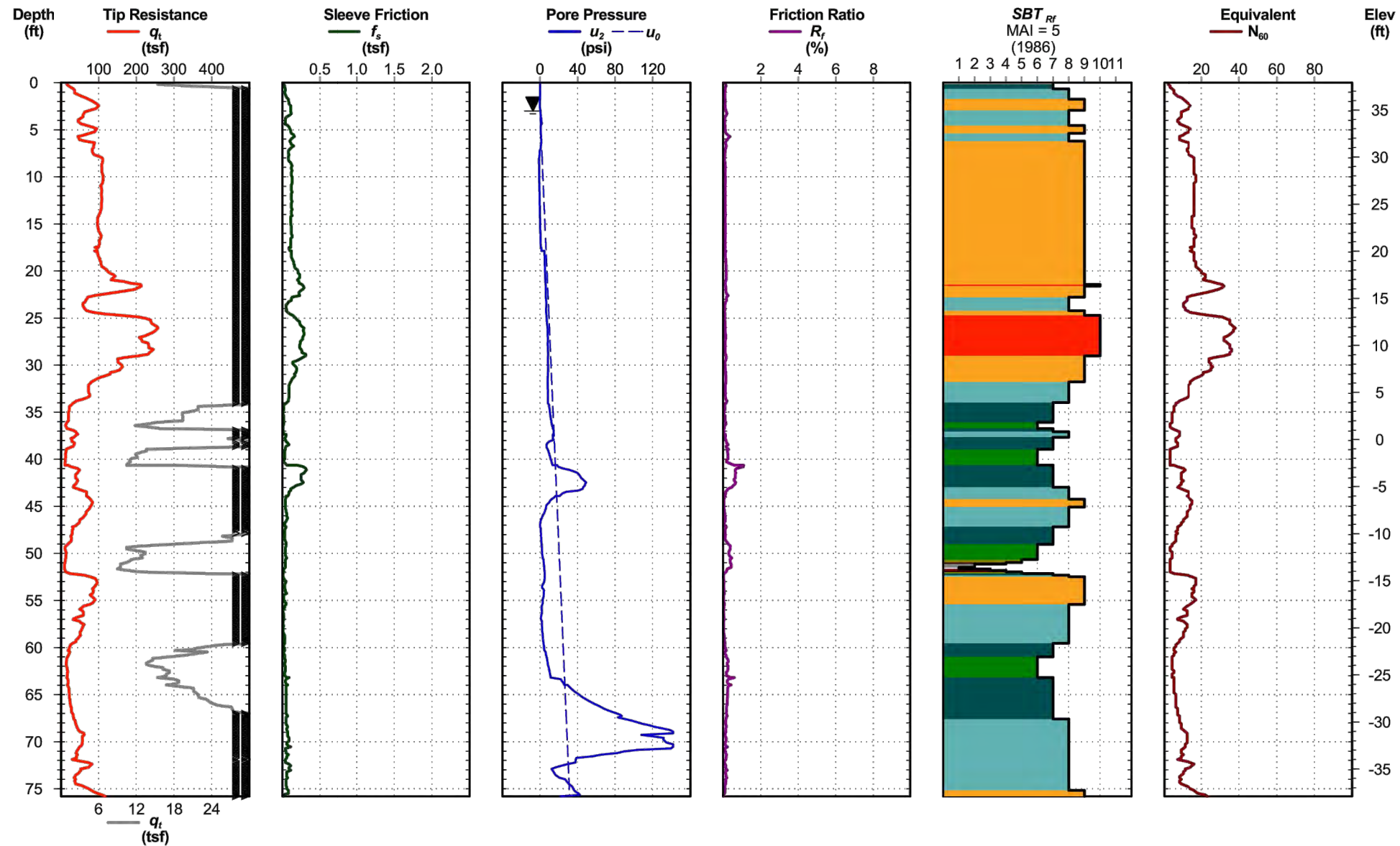
ATD 1.2

Date / Time

8/15/2023

CPT SOUNDING:
 DATE:
 NORTHING:
 EASTING:
 ELEVATION:

CPT-01
 06/29/23
 1077304
 620698
 38.0



LEGEND

Zone	Soil Behavior Type
1	Sensitive, fine grained
2	Organic soils-peat
3	Clay
4	Silty clay to clay
5	Clayey silt to silty clay
6	Sandy silt to clayey silt
7	Silty sand to sandy silt
8	Sand to silty sand
9	Sand
10	Gravelly sand to sand
11	Very stiff fine grained*
12	Sand to clayey sand*

- NOTES: 1) INTERPOLATED SOIL TYPES AND N-VALUES ARE BASED ON PUBLISHED CORRELATIONS AND SHOULD BE CONSIDERED ROUGH APPROXIMATIONS ONLY.
- 2) NORTHING AND EASTING OBTAINED USING HANDHELD GPS AND SHOULD BE CONSIDERED APPROXIMATE ONLY.
- 3) ELEVATION PROVIDED BY J-TECH BASED OFF READILY-AVAILABLE LIDAR DATA.
- 4) SBT = SOIL BEHAVIOR TYPE (ROBERTSON, 1986) MAI=MOVING AVERAGE INTERVAL

CONE SOUNDING PROFILE

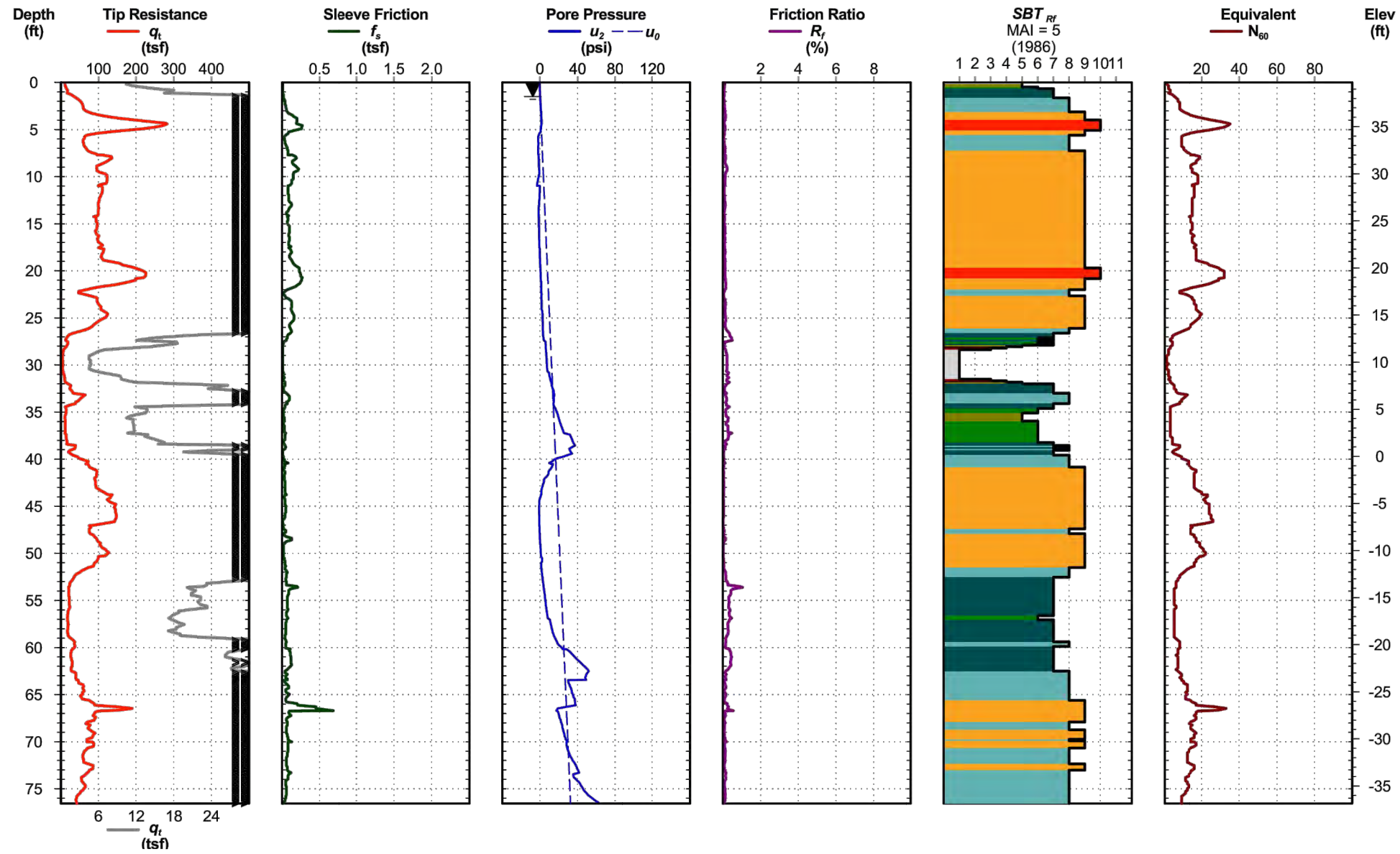


SUBSURFACE SOIL EXPLORATION
 LAKE OKEECHOBEE COMPONENT A RESERVOIR
 HIGHLANDS COUNTY, FLORIDA

DRAWN BY: CD	DATE: 07/11/23
FILE NO. 23-6363	APPROVED BY: Victor Steck, P.E.
	FIGURE:

CPT SOUNDING:
 DATE:
 NORTHING:
 EASTING:
 ELEVATION:

CPT-02
 06/30/23
 1077097
 630970
 39.7



LEGEND

Zone	Soil Behavior Type
1	Sensitive, fine grained
2	Organic soils-peat
3	Clay
4	Silty clay to clay
5	Clayey silt to silty clay
6	Sandy silt to clayey silt
7	Silty sand to sandy silt
8	Sand to silty sand
9	Sand
10	Gravelly sand to sand
11	Very stiff fine grained*
12	Sand to clayey sand*

- NOTES: 1) INTERPOLATED SOIL TYPES AND N-VALUES ARE BASED ON PUBLISHED CORRELATIONS AND SHOULD BE CONSIDERED ROUGH APPROXIMATIONS ONLY.
- 2) NORTHING AND EASTING OBTAINED USING HANDHELD GPS AND SHOULD BE CONSIDERED APPROXIMATE ONLY.
- 3) ELEVATION PROVIDED BY J-TECH BASED OFF READILY-AVAILABLE LIDAR DATA.
- 4) SBT = SOIL BEHAVIOR TYPE (ROBERTSON, 1986) MAI=MOVING AVERAGE INTERVAL

CONE SOUNDING PROFILE

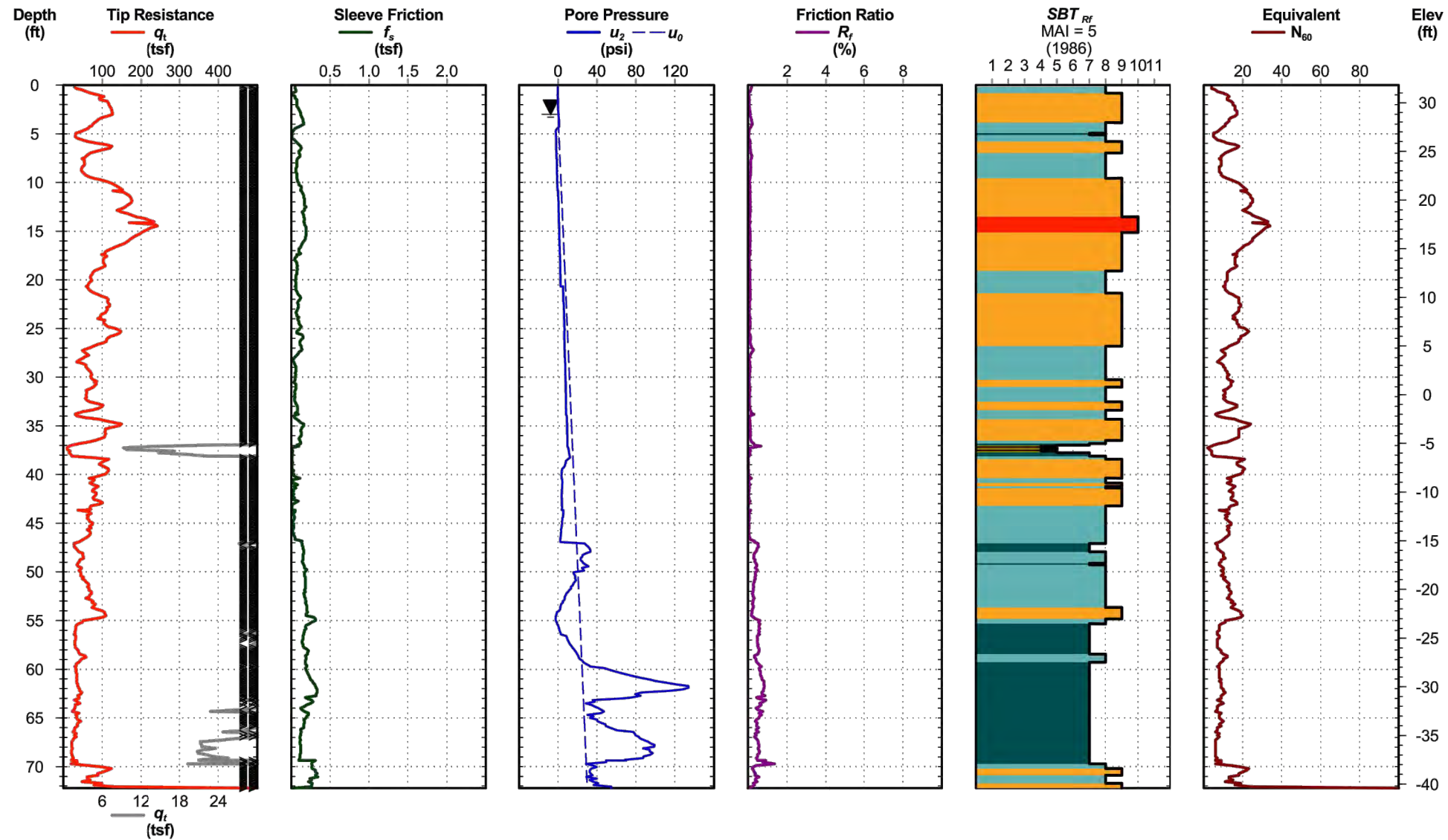


SUBSURFACE SOIL EXPLORATION
 LAKE OKEECHOBEE COMPONENT A RESERVOIR
 HIGHLANDS COUNTY, FLORIDA

DRAWN BY: CD	DATE: 07/11/23
FILE NO. 23-6363	APPROVED BY: Victor Steck, P.E.
	FIGURE:

CPT SOUNDING:
 DATE:
 NORTHING:
 EASTING:
 ELEVATION:

CPT-03
 06/27/23
 1058891
 632811
 31.8



LEGEND

Zone	Soil Behavior Type
1	Sensitive, fine grained
2	Organic soils-peat
3	Clay
4	Silty clay to clay
5	Clayey silt to silty clay
6	Sandy silt to clayey silt
7	Silty sand to sandy silt
8	Sand to silty sand
9	Sand
10	Gravelly sand to sand
11	Very stiff fine grained*
12	Sand to clayey sand*

- NOTES: 1) INTERPOLATED SOIL TYPES AND N-VALUES ARE BASED ON PUBLISHED CORRELATIONS AND SHOULD BE CONSIDERED ROUGH APPROXIMATIONS ONLY.
- 2) NORTHING AND EASTING OBTAINED USING HANDHELD GPS AND SHOULD BE CONSIDERED APPROXIMATE ONLY.
- 3) ELEVATION PROVIDED BY J-TECH BASED OFF READILY-AVAILABLE LIDAR DATA.
- 4) SBT = SOIL BEHAVIOR TYPE (ROBERTSON, 1986) MAI=MOVING AVERAGE INTERVAL

CONE SOUNDING PROFILE

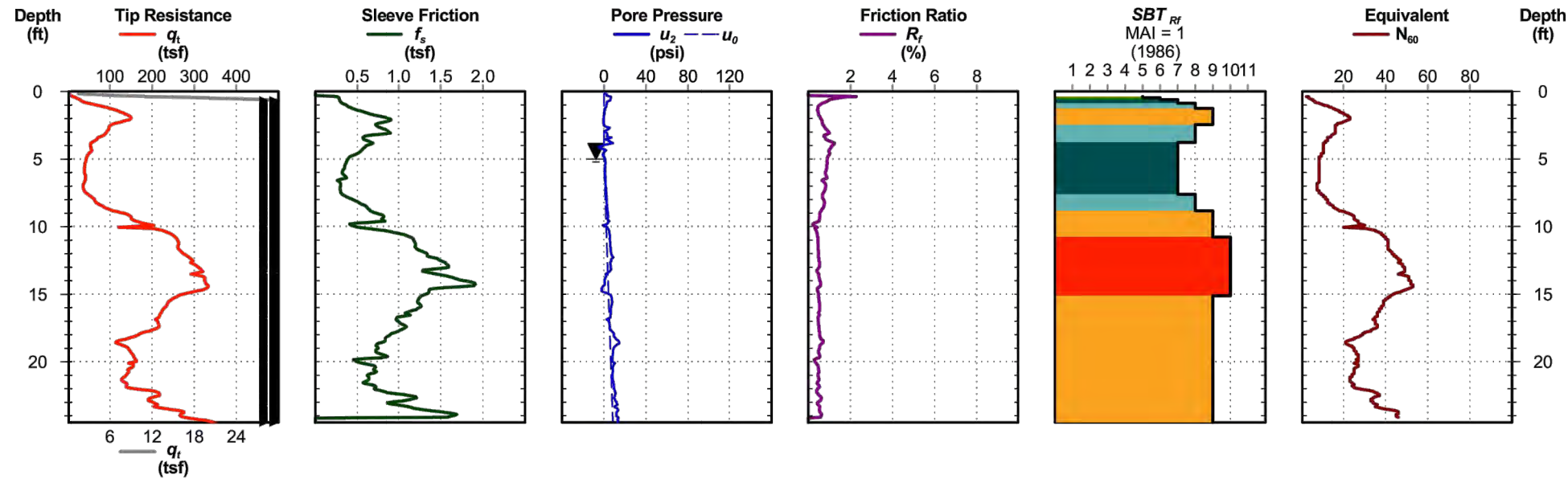


SUBSURFACE SOIL EXPLORATION
 LAKE OKEECHOBEE COMPONENT A RESERVOIR
 HIGHLANDS COUNTY, FLORIDA

DRAWN BY: CD	DATE: 07/11/23
FILE NO. 23-6363	APPROVED BY: Victor Steck, P.E.
	FIGURE:

CPT SOUNDING:
 DATE:
 NORTHING:
 EASTING:
 ELEVATION:

CPT-03A
 06/05/23
 1058891
 632811
 31.8



LEGEND

Zone	Soil Behavior Type
1	Sensitive, fine grained
2	Organic soils-peat
3	Clay
4	Silty clay to clay
5	Clayey silt to silty clay
6	Sandy silt to clayey silt
7	Silty sand to sandy silt
8	Sand to silty sand
9	Sand
10	Gravelly sand to sand
11	Very stiff fine grained*
12	Sand to clayey sand*

- NOTES: 1) INTERPOLATED SOIL TYPES AND N-VALUES ARE BASED ON PUBLISHED CORRELATIONS AND SHOULD BE CONSIDERED ROUGH APPROXIMATIONS ONLY.
- 2) NORTHING AND EASTING OBTAINED USING HANDHELD GPS AND SHOULD BE CONSIDERED APPROXIMATE ONLY.
- 3) ELEVATION PROVIDED BY J-TECH BASED OFF READILY-AVAILABLE LIDAR DATA.
- 4) SBT = SOIL BEHAVIOR TYPE (ROBERTSON, 1986) MAI=MOVING AVERAGE INTERVAL

CONE SOUNDING PROFILE

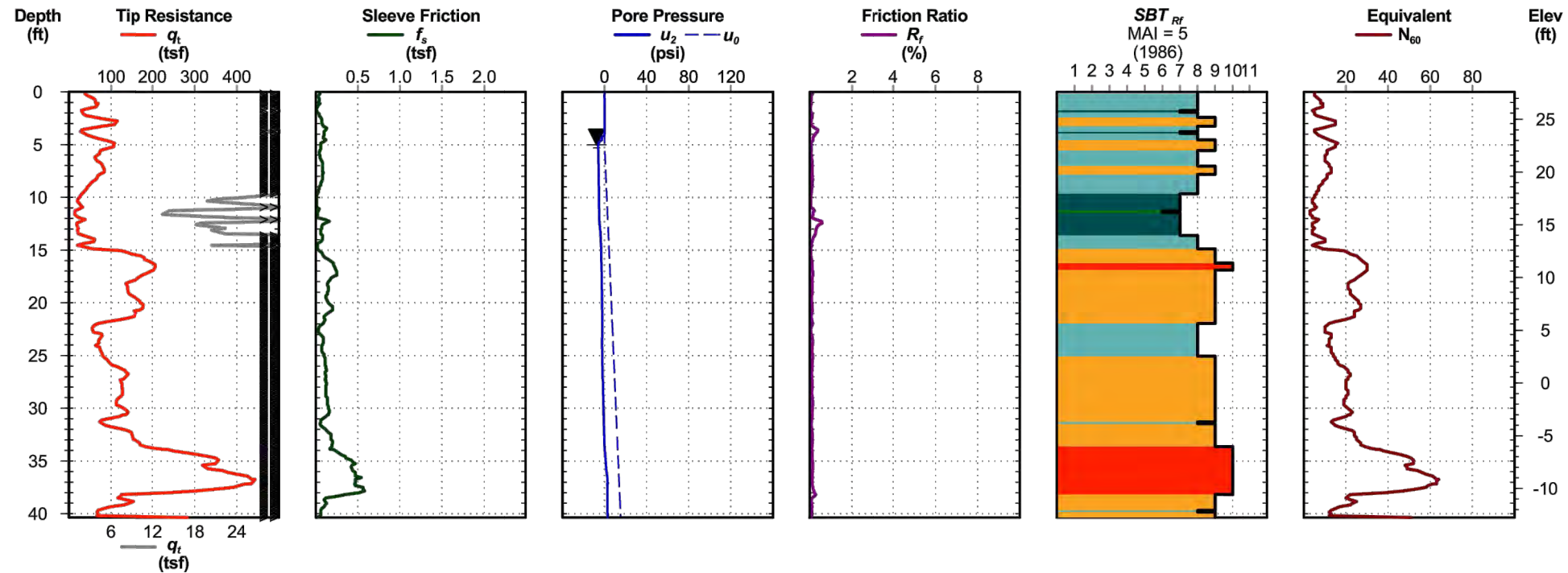


SUBSURFACE SOIL EXPLORATION
 LAKE OKEECHOBEE COMPONENT A RESERVOIR
 HIGHLANDS COUNTY, FLORIDA

DRAWN BY: CD	DATE: 07/11/23
FILE NO. 23-6363	APPROVED BY: Victor Steck, P.E.
	FIGURE:

CPT SOUNDING:
 DATE:
 NORTHING:
 EASTING:
 ELEVATION:

CPT-04
 06/30/23
 1064296
 605049
 27.6



LEGEND

Zone	Soil Behavior Type
1	Sensitive, fine grained
2	Organic soils-peat
3	Clay
4	Silty clay to clay
5	Clayey silt to silty clay
6	Sandy silt to clayey silt
7	Silty sand to sandy silt
8	Sand to silty sand
9	Sand
10	Gravelly sand to sand
11	Very stiff fine grained*
12	Sand to clayey sand*

- NOTES: 1) INTERPOLATED SOIL TYPES AND N-VALUES ARE BASED ON PUBLISHED CORRELATIONS AND SHOULD BE CONSIDERED ROUGH APPROXIMATIONS ONLY.
- 2) NORTHING AND EASTING OBTAINED USING HANDHELD GPS AND SHOULD BE CONSIDERED APPROXIMATE ONLY.
- 3) ELEVATION PROVIDED BY J-TECH BASED OFF READILY-AVAILABLE LIDAR DATA.
- 4) SBT = SOIL BEHAVIOR TYPE (ROBERTSON, 1986)
 MAI=MOVING AVERAGE INTERVAL

CONE SOUNDING PROFILE

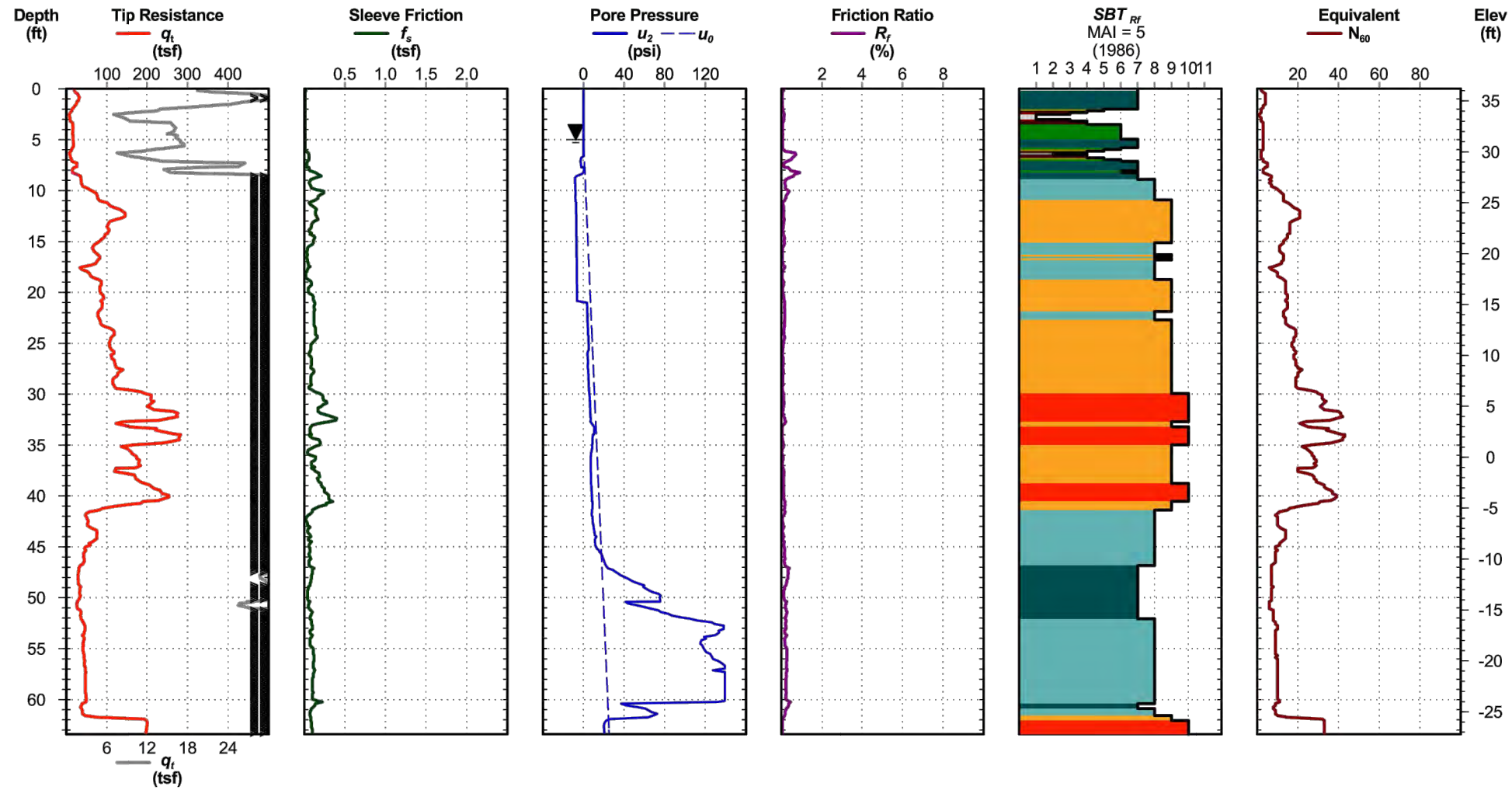


SUBSURFACE SOIL EXPLORATION
 LAKE OKEECHOBEE COMPONENT A RESERVOIR
 HIGHLANDS COUNTY, FLORIDA

DRAWN BY: CD	DATE: 07/11/23
FILE NO. 23-6363	APPROVED BY: Victor Steck, P.E.
	FIGURE:

CPT SOUNDING:
 DATE:
 NORTHING:
 EASTING:
 ELEVATION:

CPT-05
 06/28/23
 1069635
 601617
 36.2



LEGEND

Zone	Soil Behavior Type
1	Sensitive, fine grained
2	Organic soils-peat
3	Clay
4	Silty clay to clay
5	Clayey silt to silty clay
6	Sandy silt to clayey silt
7	Silty sand to sandy silt
8	Sand to silty sand
9	Sand
10	Gravelly sand to sand
11	Very stiff fine grained*
12	Sand to clayey sand*

- NOTES: 1) INTERPOLATED SOIL TYPES AND N-VALUES ARE BASED ON PUBLISHED CORRELATIONS AND SHOULD BE CONSIDERED ROUGH APPROXIMATIONS ONLY.
- 2) NORTHING AND EASTING OBTAINED USING HANDHELD GPS AND SHOULD BE CONSIDERED APPROXIMATE ONLY.
- 3) ELEVATION PROVIDED BY J-TECH BASED OFF READILY-AVAILABLE LIDAR DATA.
- 4) SBT = SOIL BEHAVIOR TYPE (ROBERTSON, 1986) MAI=MOVING AVERAGE INTERVAL

CONE SOUNDING PROFILE

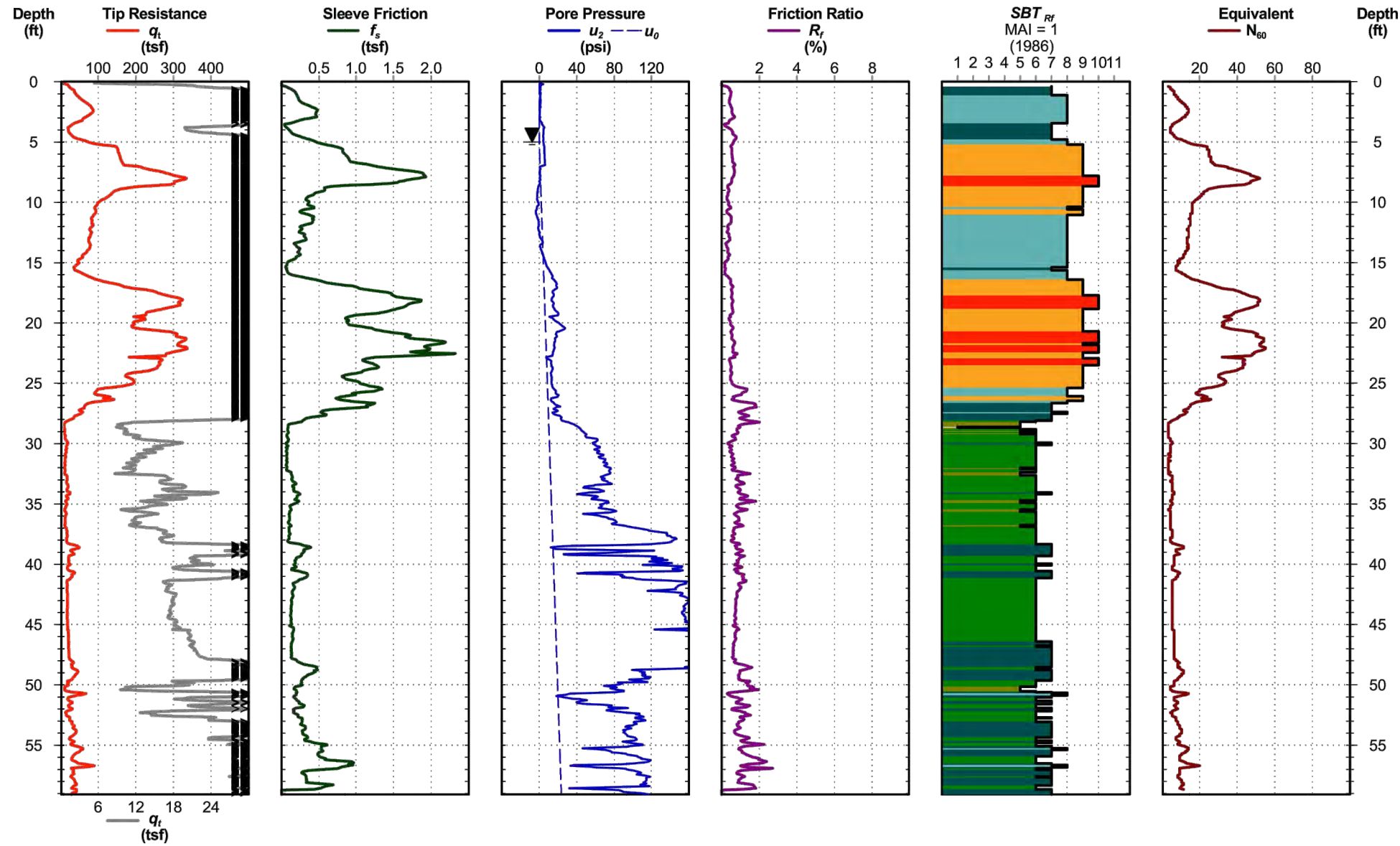


SUBSURFACE SOIL EXPLORATION
 LAKE OKEECHOBEE COMPONENT A RESERVOIR
 HIGHLANDS COUNTY, FLORIDA

DRAWN BY: CD	DATE: 07/11/23
FILE NO. 23-6363	APPROVED BY: Victor Steck, P.E.
	FIGURE:

CPT SOUNDING:
 DATE:
 NORTHING:
 EASTING:
 ELEVATION:

CPT-06
 06/05/23
 1072298
 618117
 36.8



LEGEND

Zone	Soil Behavior Type
1	Sensitive, fine grained
2	Organic soils-peat
3	Clay
4	Silty clay to clay
5	Clayey silt to silty clay
6	Sandy silt to clayey silt
7	Silty sand to sandy silt
8	Sand to silty sand
9	Sand
10	Gravelly sand to sand
11	Very stiff fine grained*
12	Sand to clayey sand*

- NOTES: 1) INTERPOLATED SOIL TYPES AND N-VALUES ARE BASED ON PUBLISHED CORRELATIONS AND SHOULD BE CONSIDERED ROUGH APPROXIMATIONS ONLY.
- 2) NORTHING AND EASTING OBTAINED USING HANDHELD GPS AND SHOULD BE CONSIDERED APPROXIMATE ONLY.
- 3) ELEVATION PROVIDED BY J-TECH BASED OFF READILY-AVAILABLE LIDAR DATA.
- 4) SBT = SOIL BEHAVIOR TYPE (ROBERTSON, 1986)
 MAI=MOVING AVERAGE INTERVAL

CONE SOUNDING PROFILE

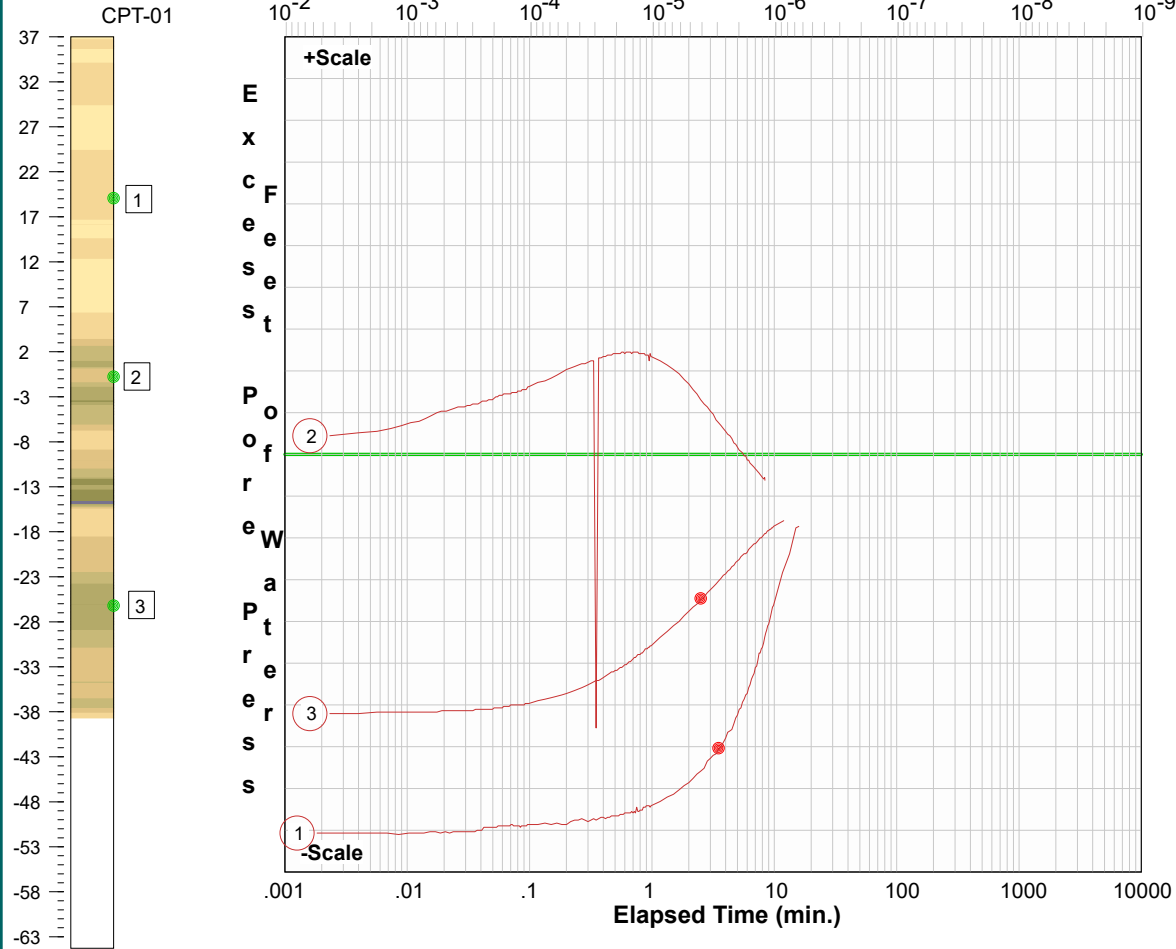


SUBSURFACE SOIL EXPLORATION
 LAKE OKEECHOBEE COMPONENT A RESERVOIR
 HIGHLANDS COUNTY, FLORIDA

DRAWN BY: CD	DATE: 07/11/23
FILE NO. 23-6363	APPROVED BY: Victor Steck, P.E.
	FIGURE:

Normalized Soil Behavior
(Robertson et al, 1986, 1990)
Sounding Number

STATIC PORE PRESSURE DECAY



Track Number	T-50 (min)	Ch (cm ² /min)	Estimated kh (cm/sec)
1	3.5	2.8 X 10 ⁻¹	2 X 10 ⁻⁶
2			
3	2.5	4 X 10 ⁻¹	2.8 X 10 ⁻⁶

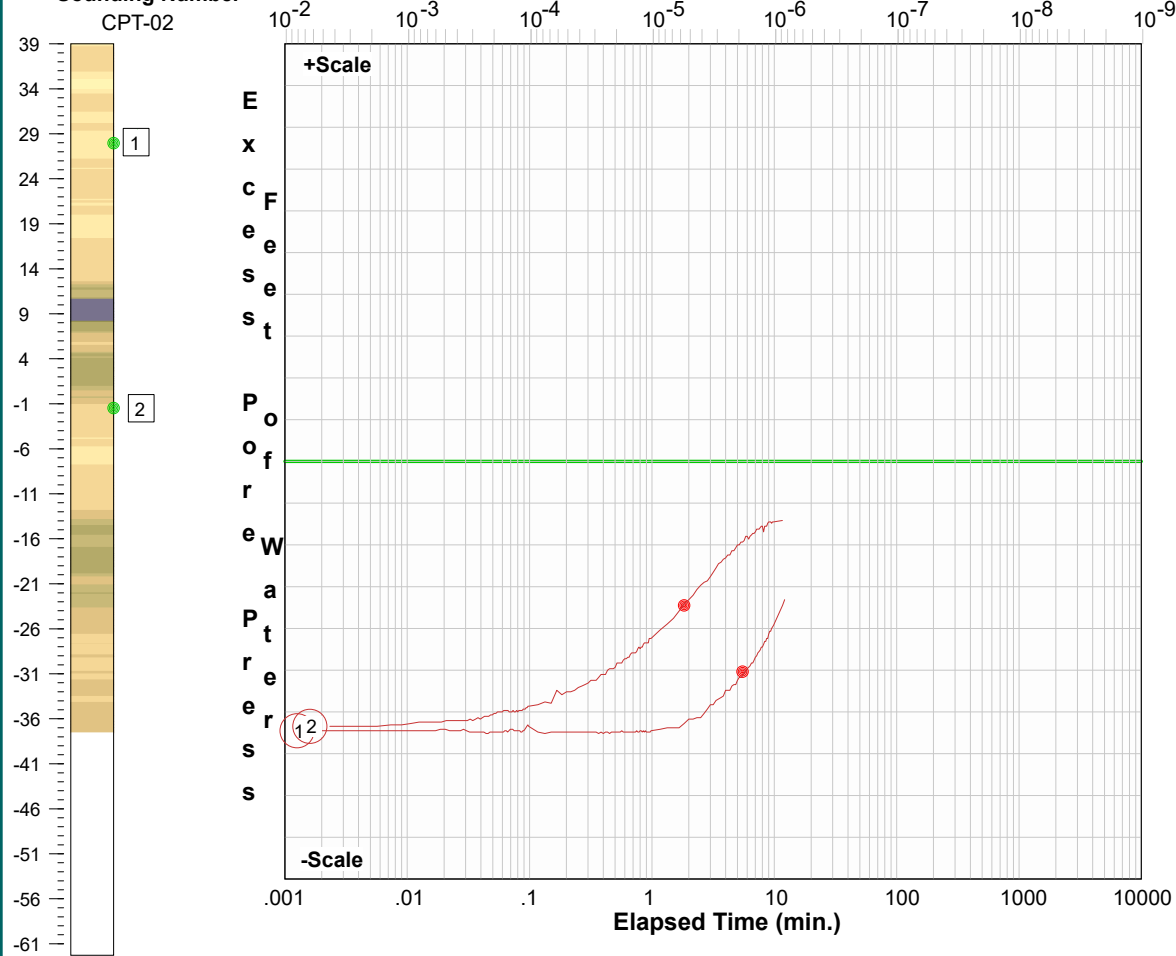
Computer selected t50... ●
Manually selected t50..... ●

insitu group

Ardaman & Associates
LOCAR Project
Sounding # CPT-01
06-29-2023 14:51:38

Normalized Soil Behavior
(Robertson et al, 1986, 1990)
Sounding Number

STATIC PORE PRESSURE DECAY



Track Number	T-50 (min)	Ch (cm ² /min)	Estimated kh (cm/sec)
1	5.5	1.8 X 10 ⁻¹	1.2 X 10 ⁻⁶
2	1.833	5.4 X 10 ⁻¹	3.9 X 10 ⁻⁶

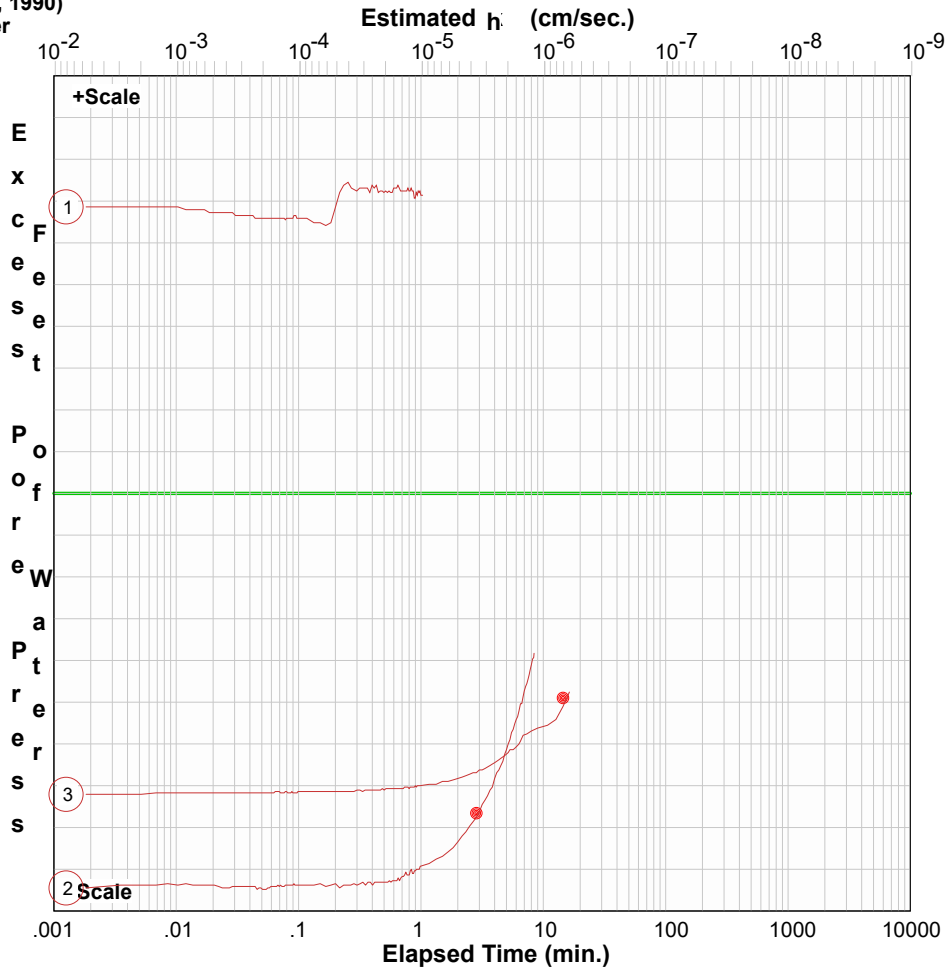
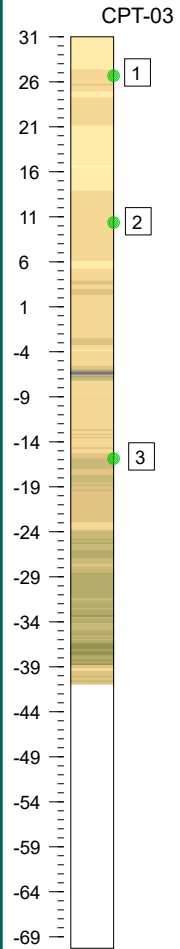
Computer selected t50... ●
Manually selected t50..... ●

insitu group

Ardaman & Associates
LOCAR Project
Sounding # CPT-02
06-30-2023 11:18:28

Normalized Soil Behavior
(Robertson et al, 1986, 1990)
Sounding Number

STATIC PORE PRESSURE DECAY



Track Number	T-50 (min)	Ch (cm ² /min)	Estimated kh (cm/sec)
1			
2	● 2.833	3.5×10^{-1}	2.5×10^{-6}
3	● 14.5	6.8×10^{-2}	4.5×10^{-7}

Computer selected t50... ●
Manually selected t50..... ●

insitu group

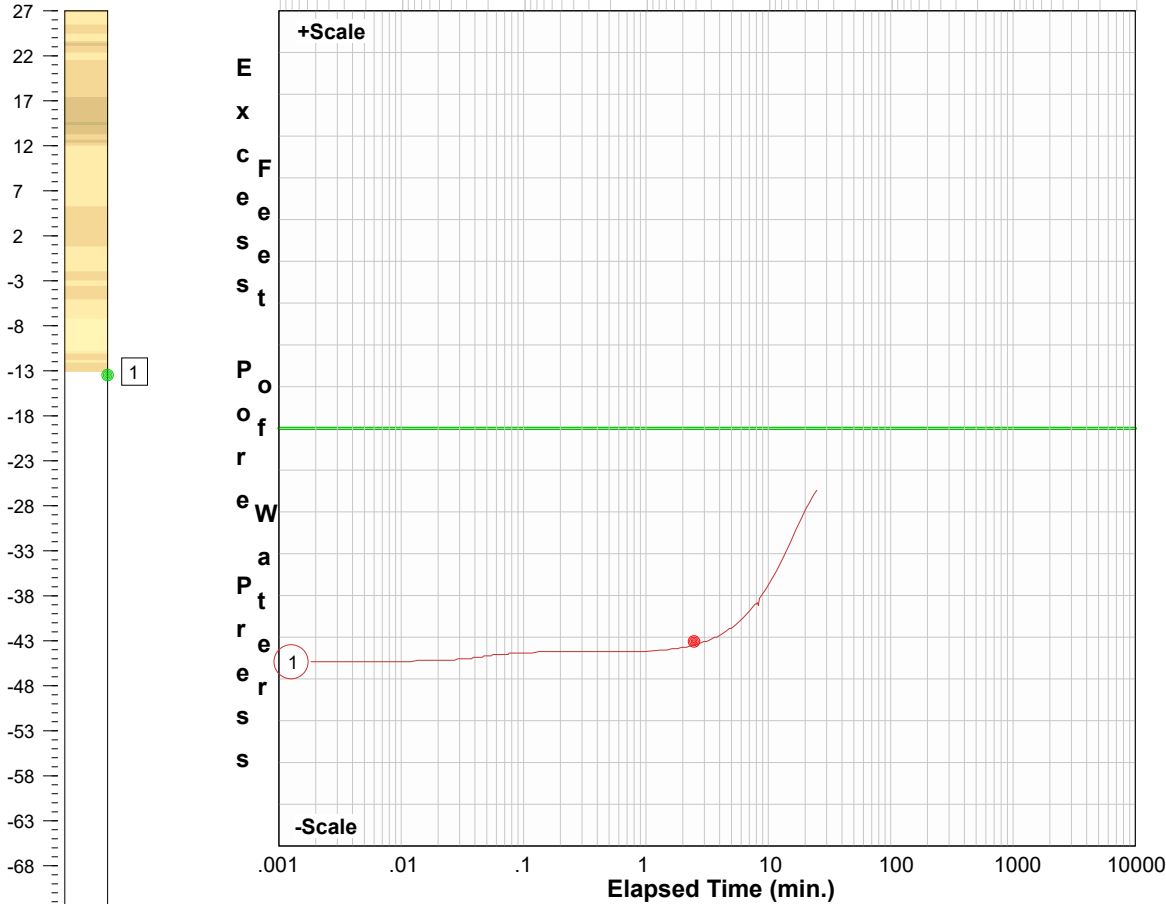
Ardaman & Associates
LOCAR Project
Sounding # CPT-03
06-27-2023 11:20:01

Normalized Soil Behavior
(Robertson et al, 1986, 1990)
Sounding Number

STATIC PORE PRESSURE DECAY

Estimated h (cm/sec.)

CPT-04



Track Number	T-50 (min)	Ch (cm ² /min)	Estimated kh (cm/sec)
1	2.471	4 X 10 ⁻¹	2.8 X 10 ⁻⁶

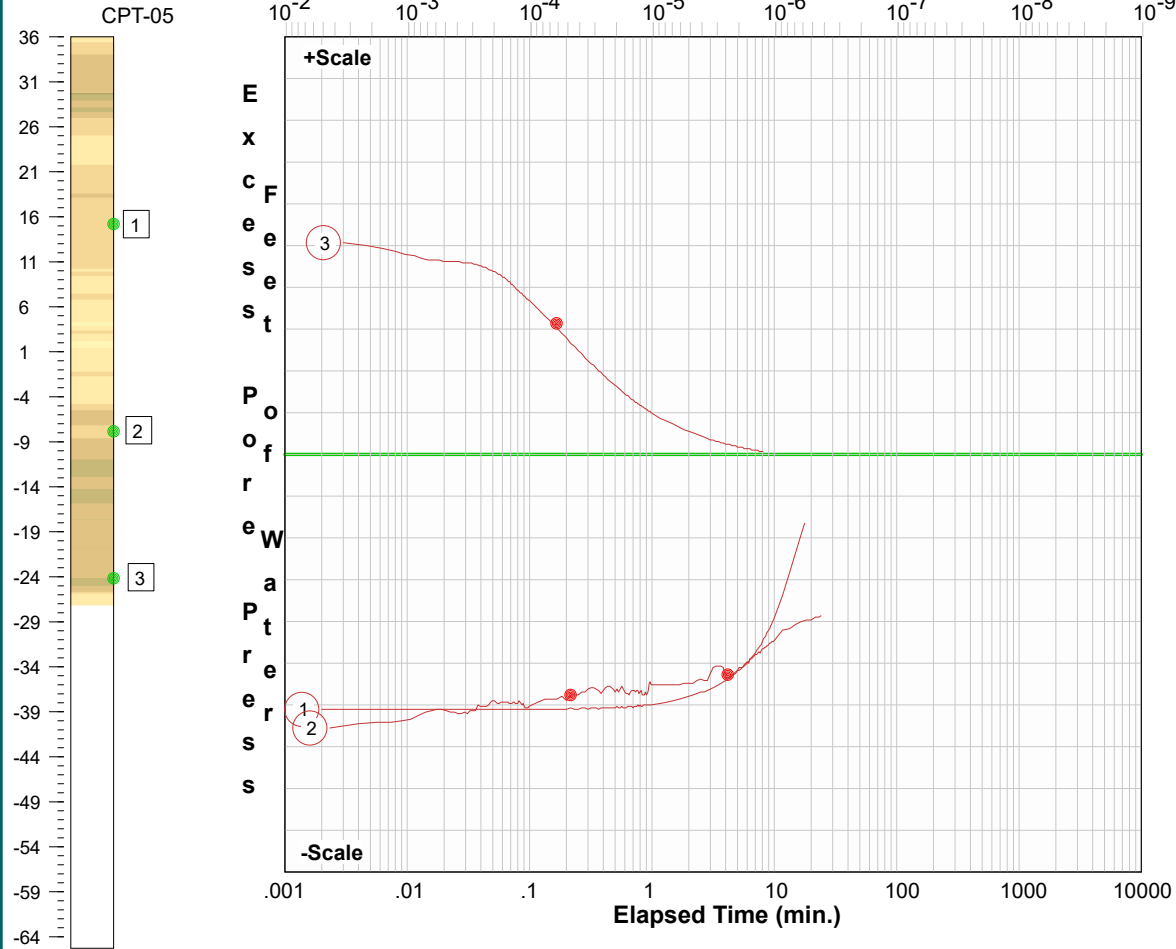
Computer selected t50... ●
Manually selected t50..... ●

insitu group

Ardaman & Associates
LOCAR Project
Sounding # CPT-04
06-30-2023 14:51:20

Normalized Soil Behavior
(Robertson et al, 1986, 1990)
Sounding Number

STATIC PORE PRESSURE DECAY



Track Number	T-50 (min)	Ch (cm ² /min)	Estimated kh (cm/sec)
1	4.166	2.4 X 10 ⁻¹	1.6 X 10 ⁻⁶
2	0.216	4.6 X 10 ⁰	3.6 X 10 ⁻⁵
3	0.166	6 X 10 ⁰	4.8 X 10 ⁻⁵

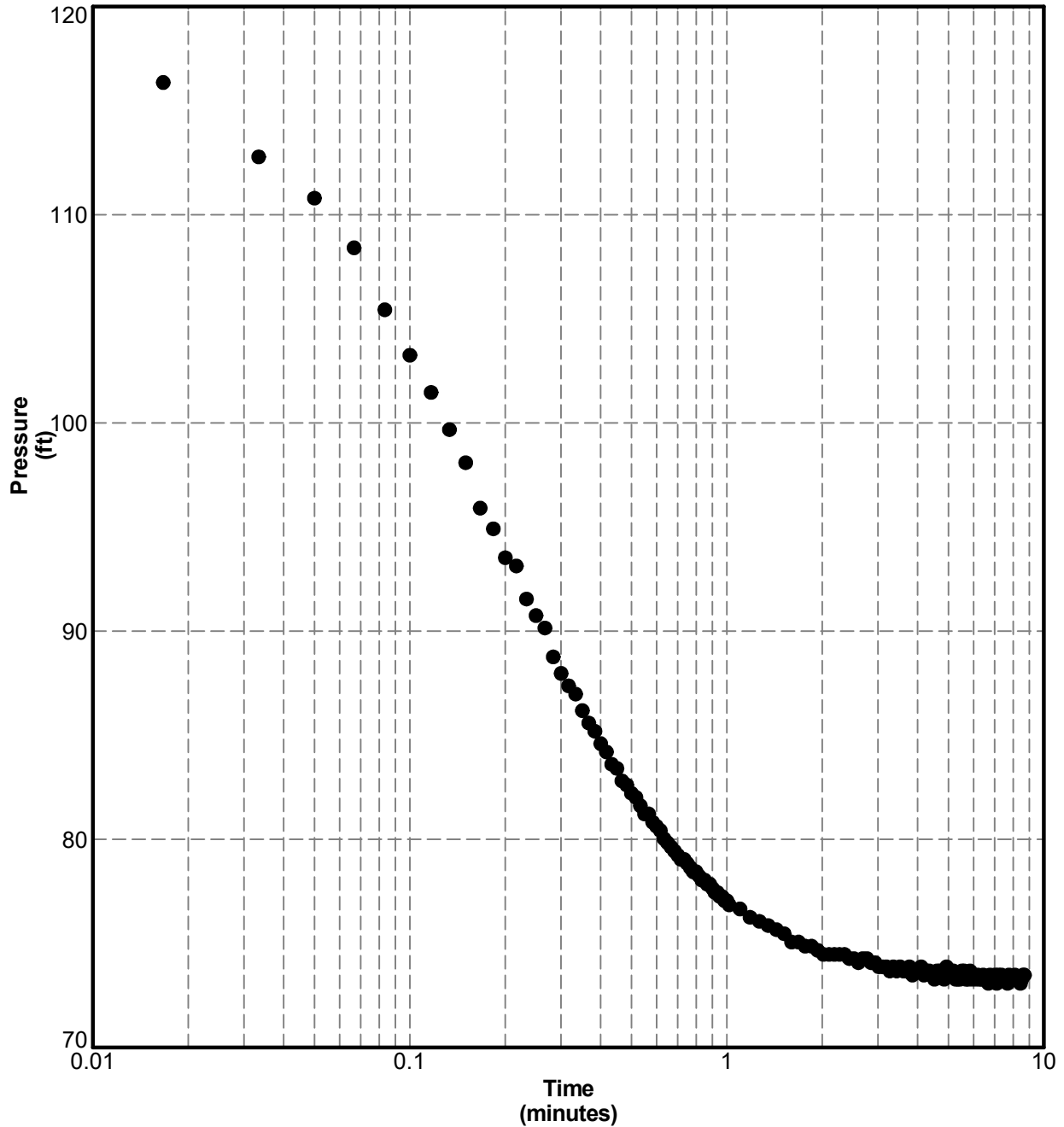
Computer selected t50... ●
Manually selected t50..... ●

insitu group

Ardaman & Associates
LOCAR Project
Sounding # CPT-05
06-28-2023 11:16:17

Date: Jun. 5, 2023
Estimated Water Depth:
Rig/Operator: ag | jw

Total Depth: 59.1 ft
Termination Criteria:
Test Depth: 59.1 ft

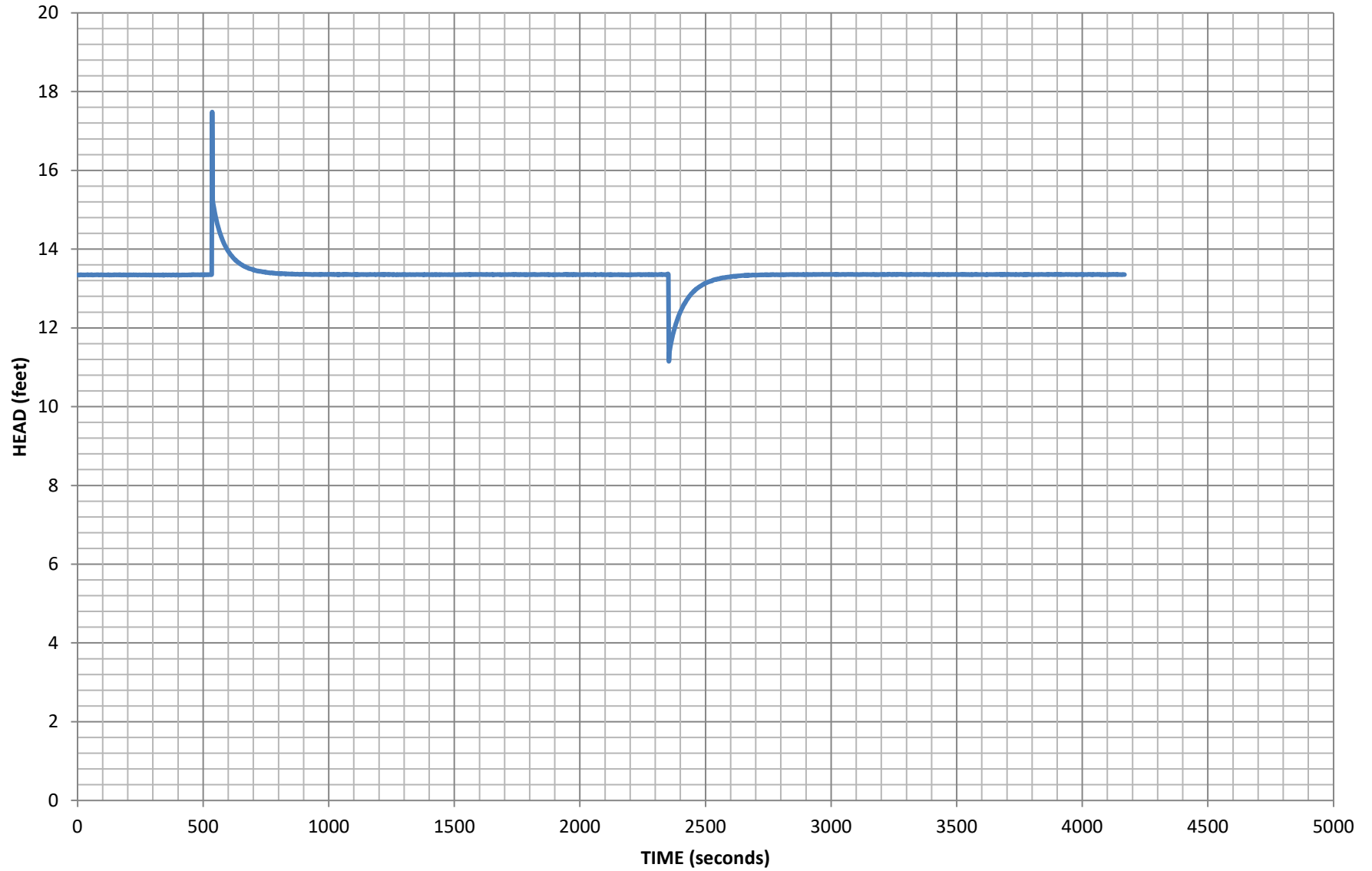


ESTIMATED Kh: 1×10^{-5} (cm/sec)

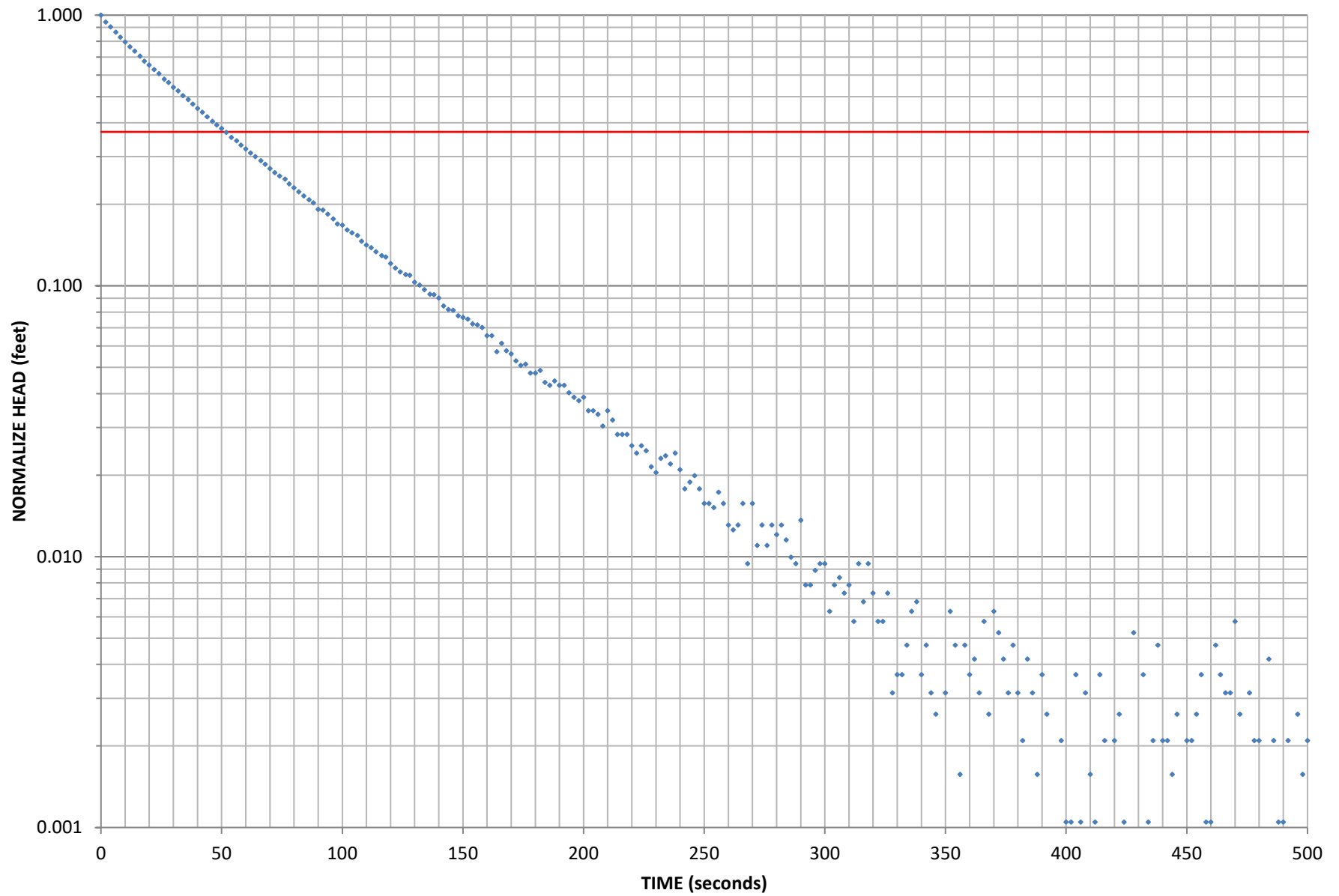
APPENDIX III

Slug Test Water Level Versus Time Curves

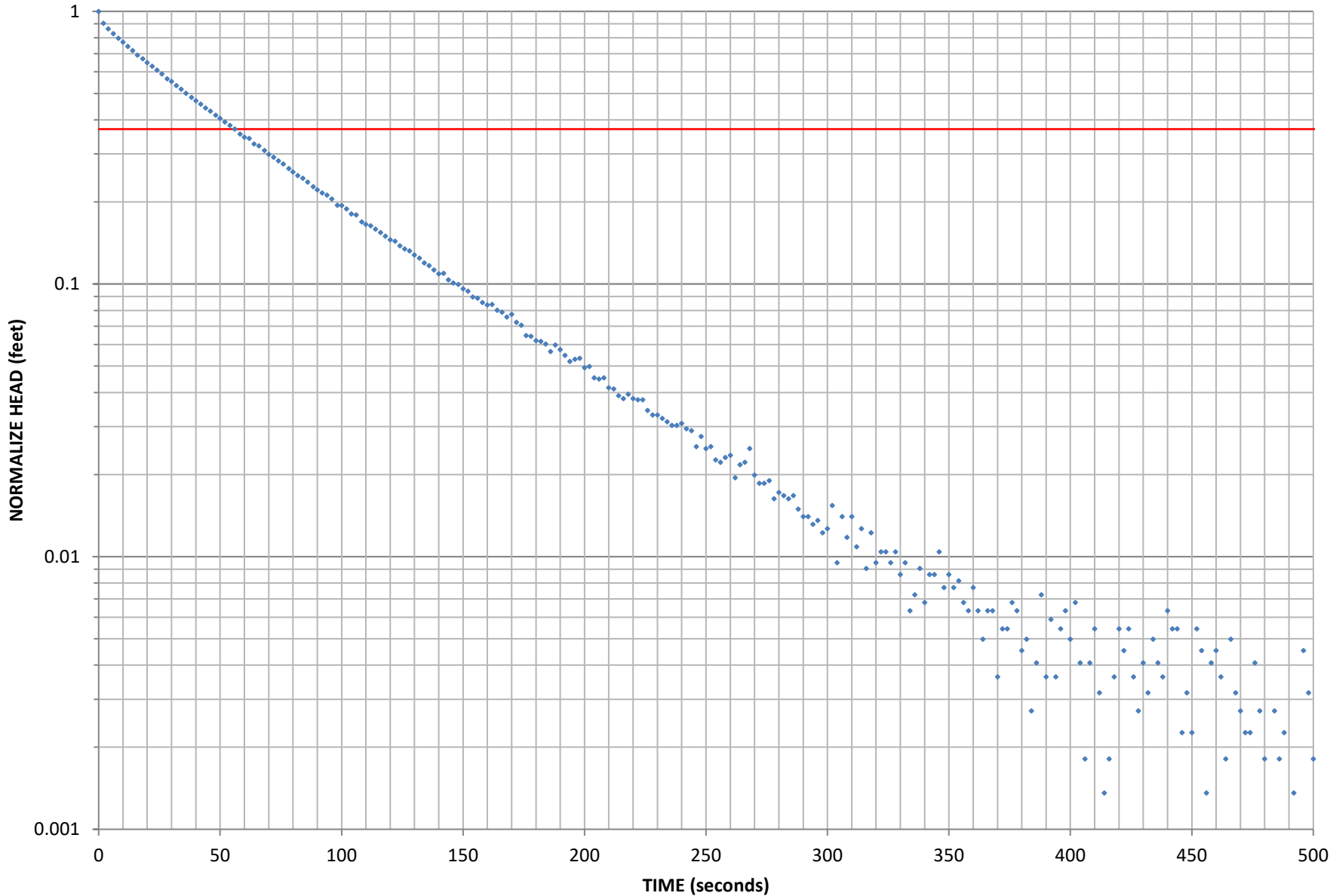
LYKES RANCH PZ-01S PERMEABILITY SLUG TEST



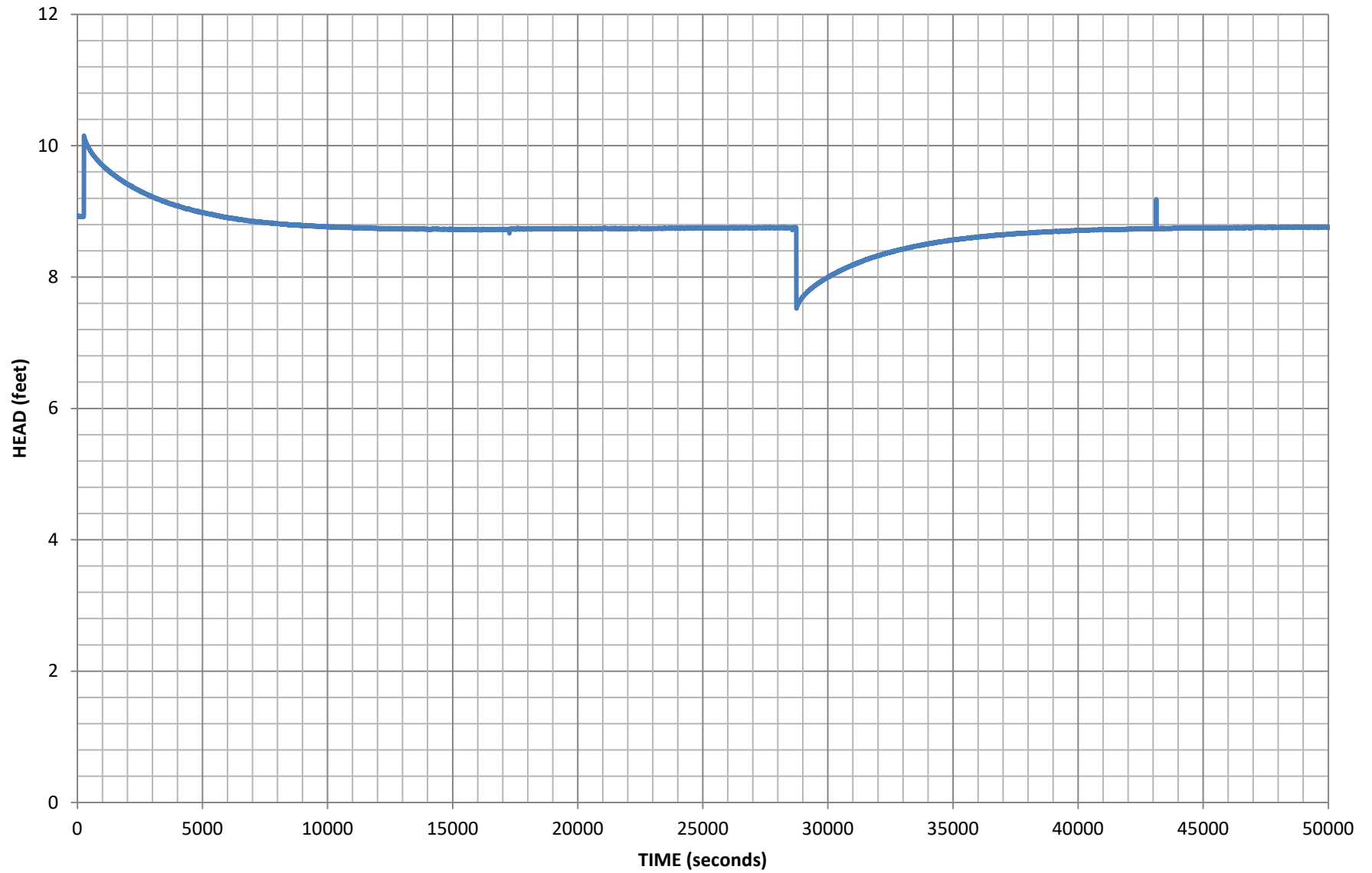
PZ-01S FALLING HEAD SLUG TEST



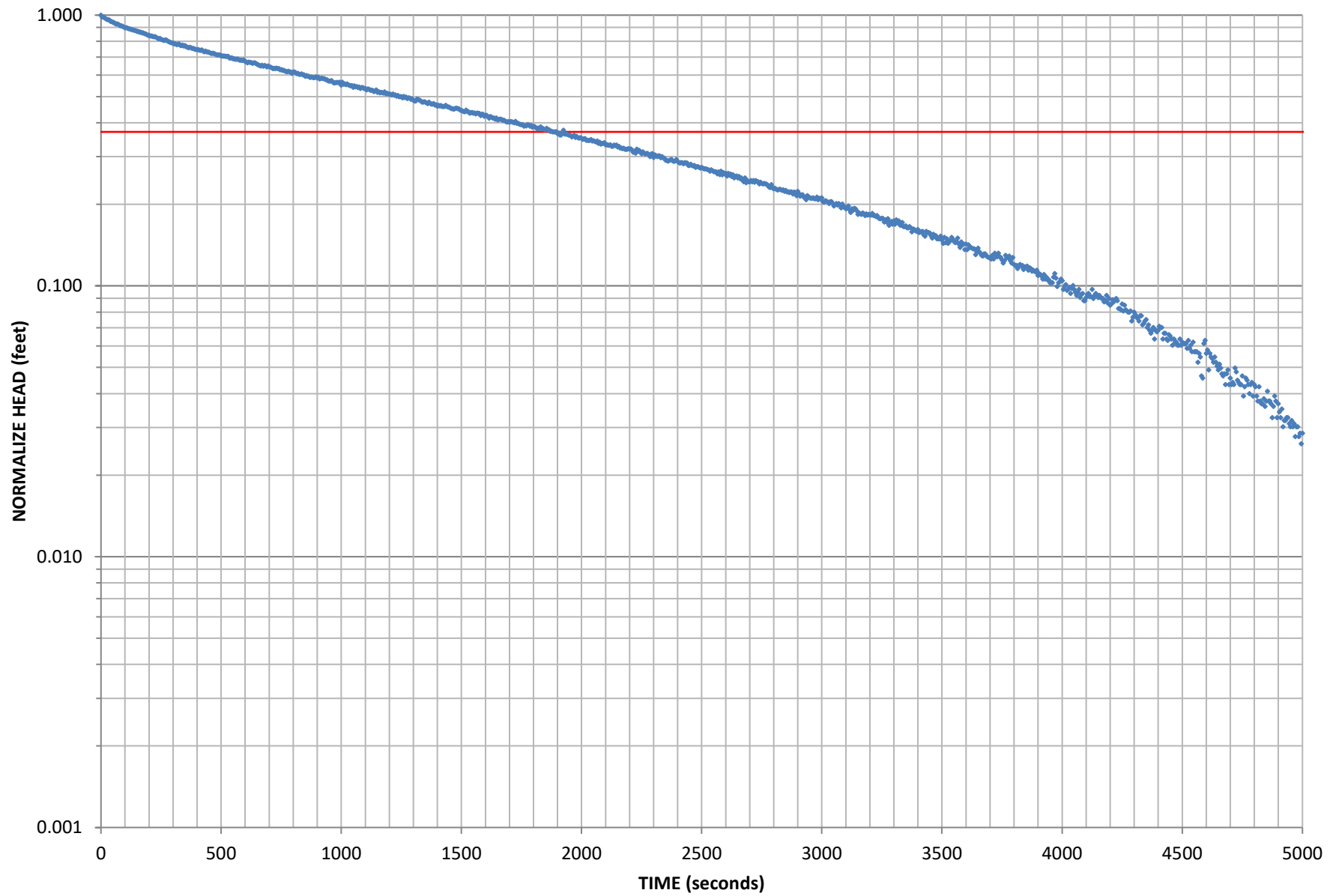
PZ-01S RISING HEAD SLUG TEST



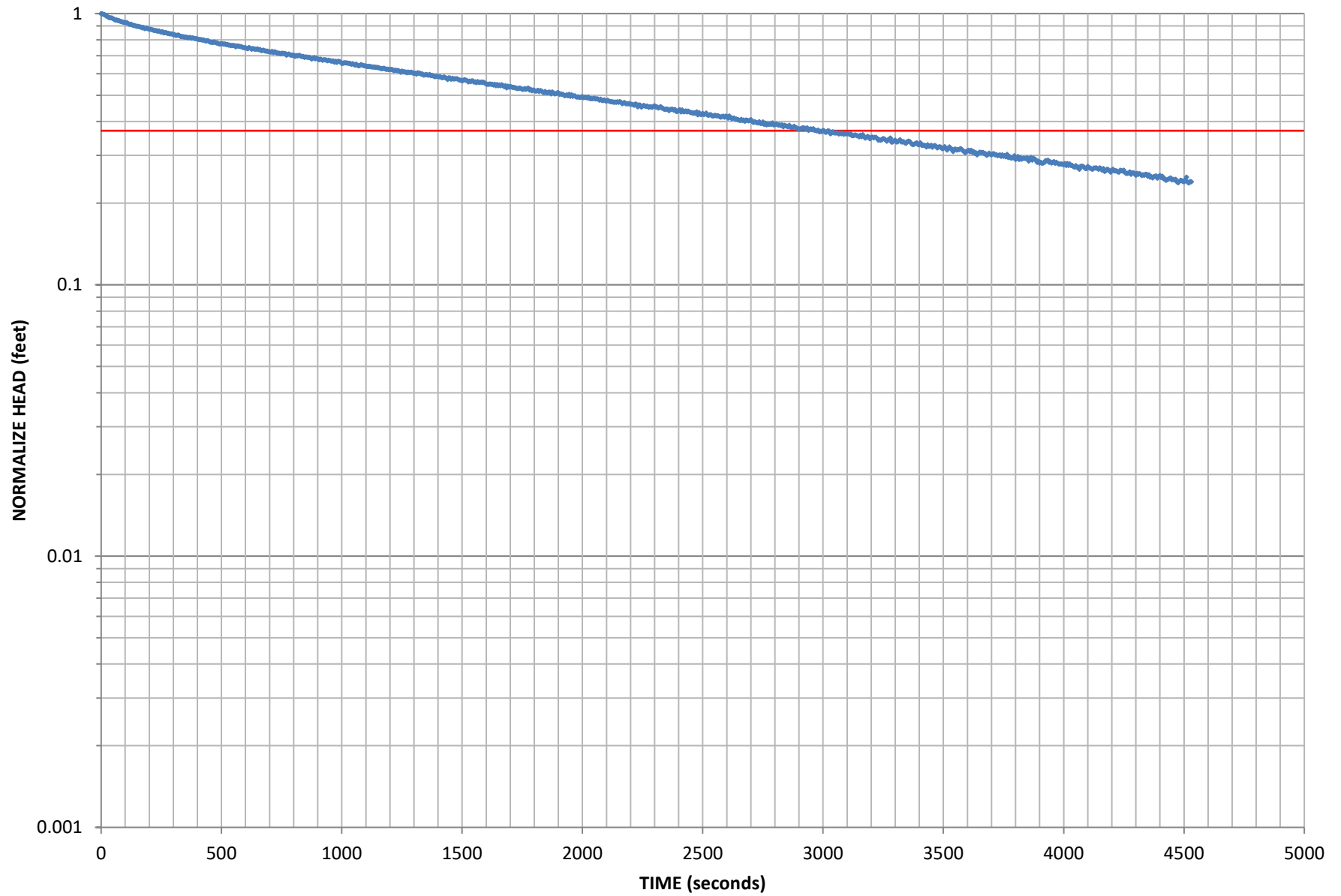
LYKES RANCH PZ-01S PERMEABILITY SLUG TEST



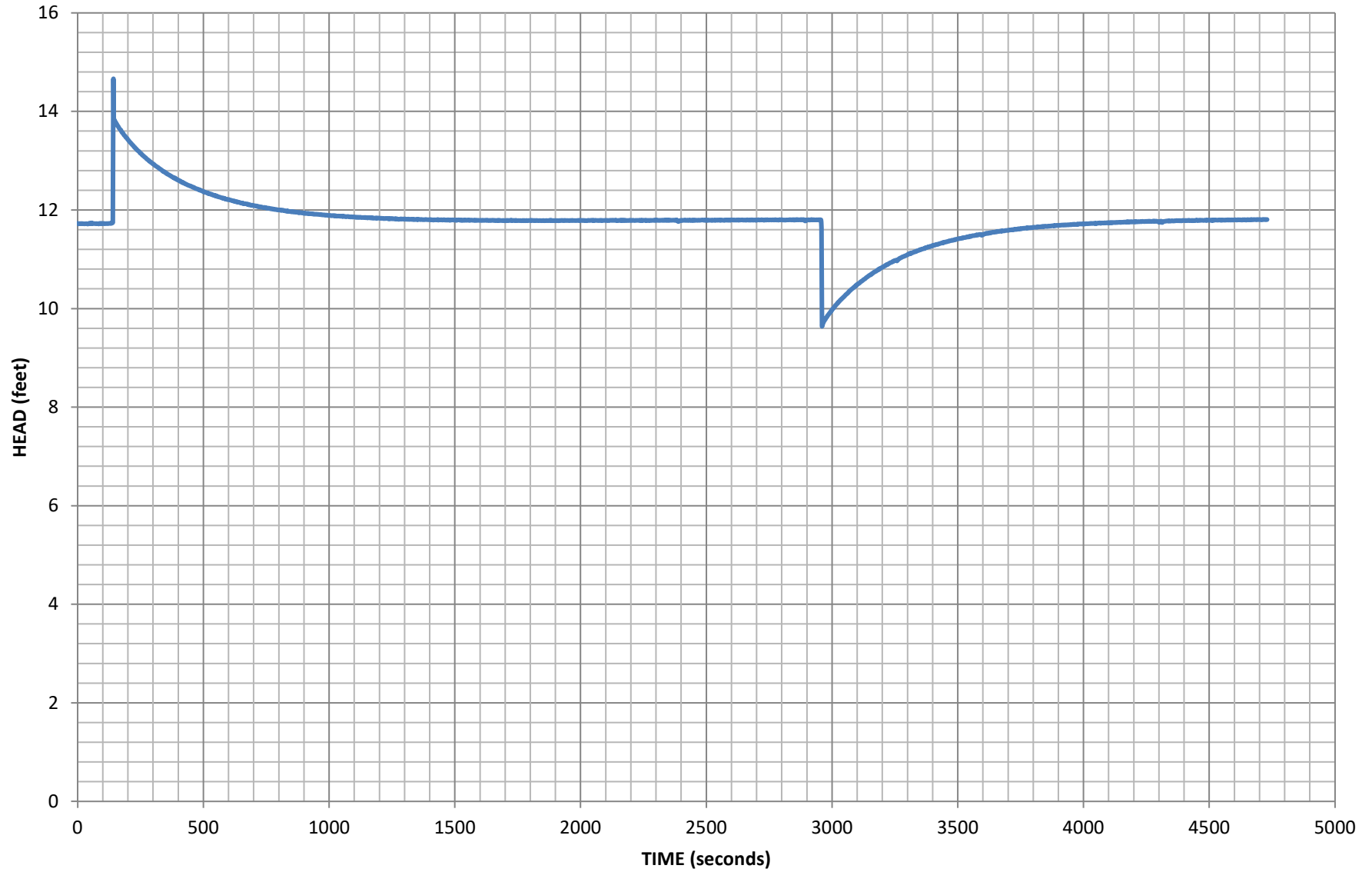
PZ-01D FALLING HEAD SLUG TEST



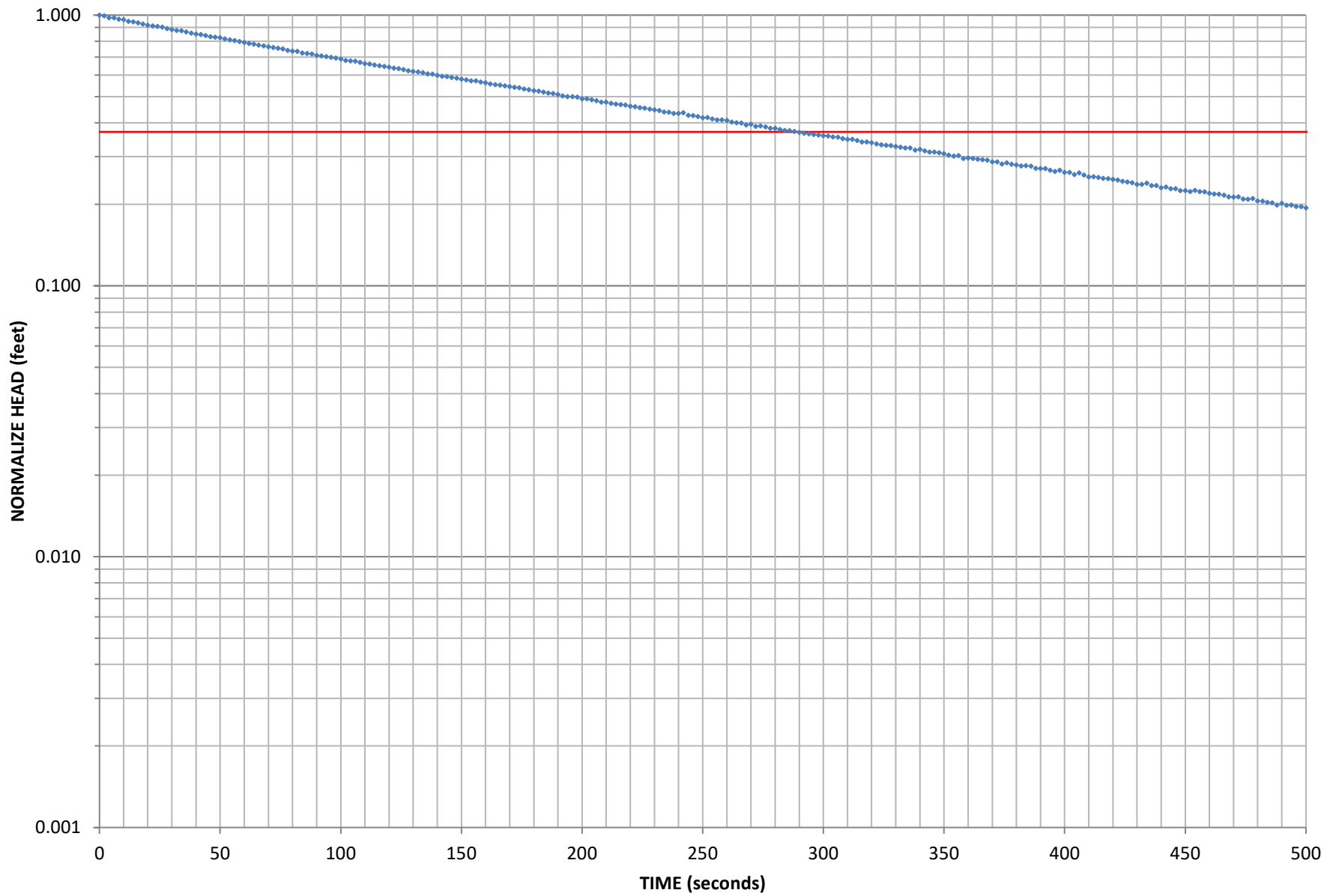
PZ-01D RISING HEAD SLUG TEST



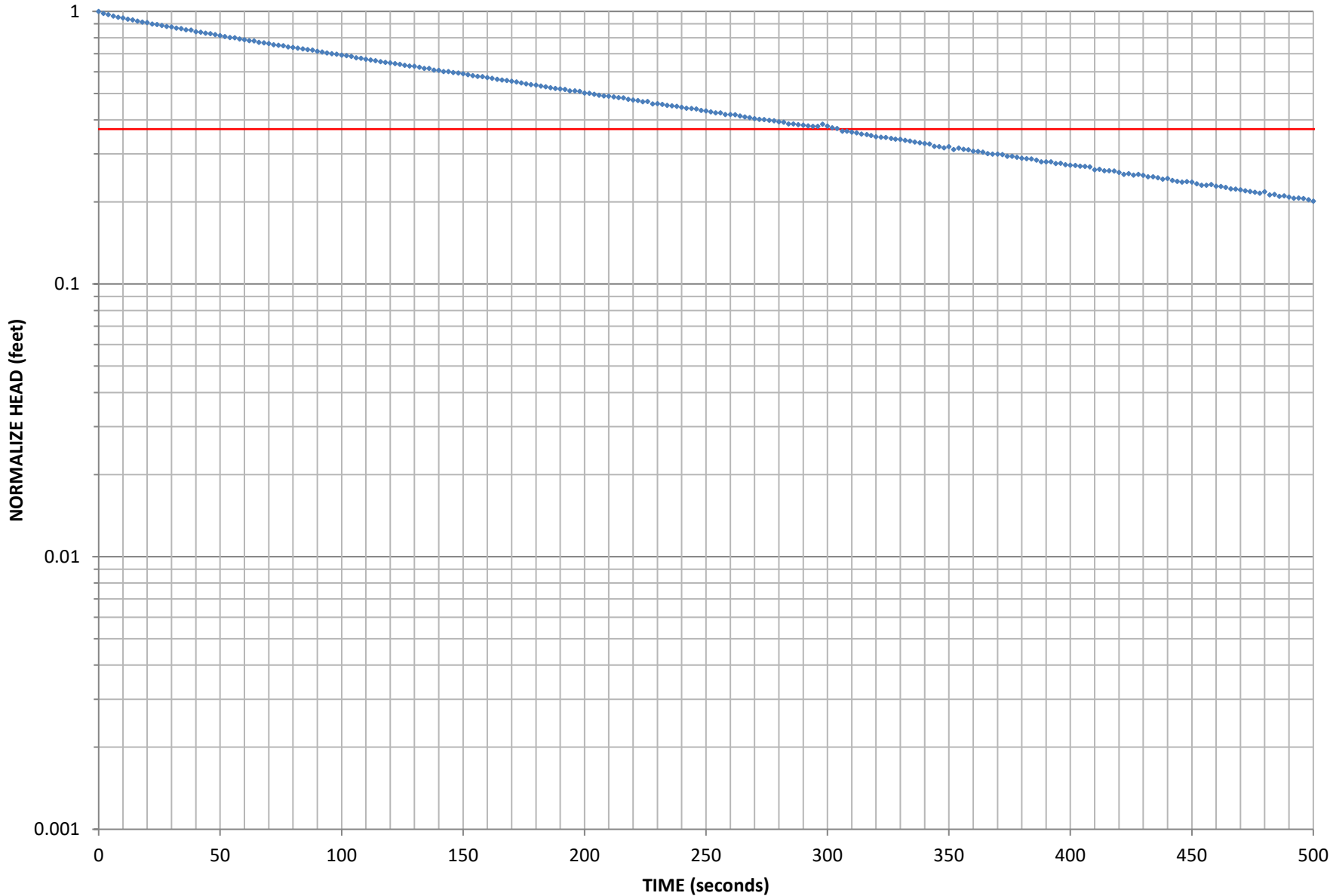
LYKES RANCH PZ-02S PERMEABILITY SLUG TEST



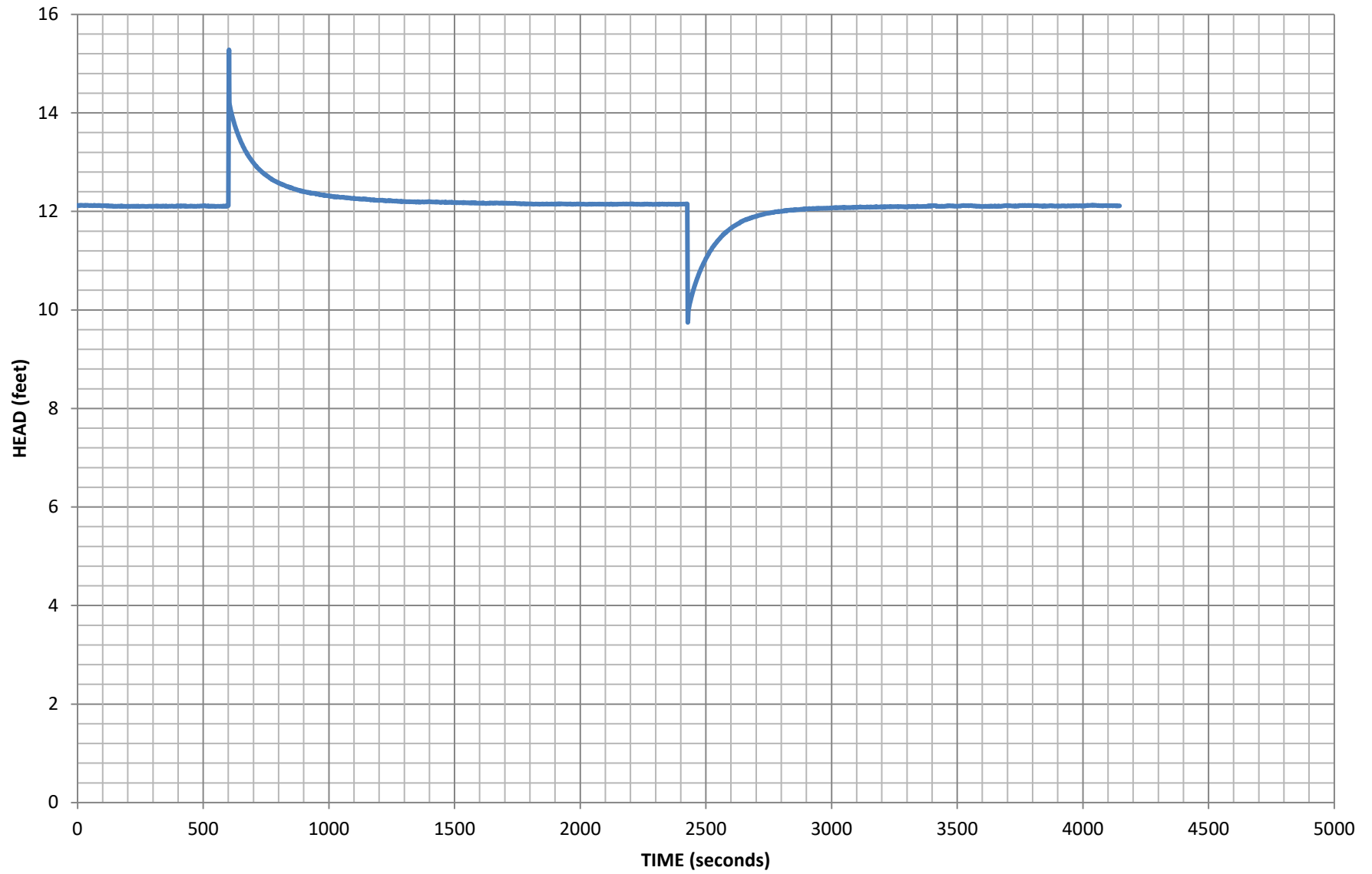
PZ-02S FALLING HEAD SLUG TEST



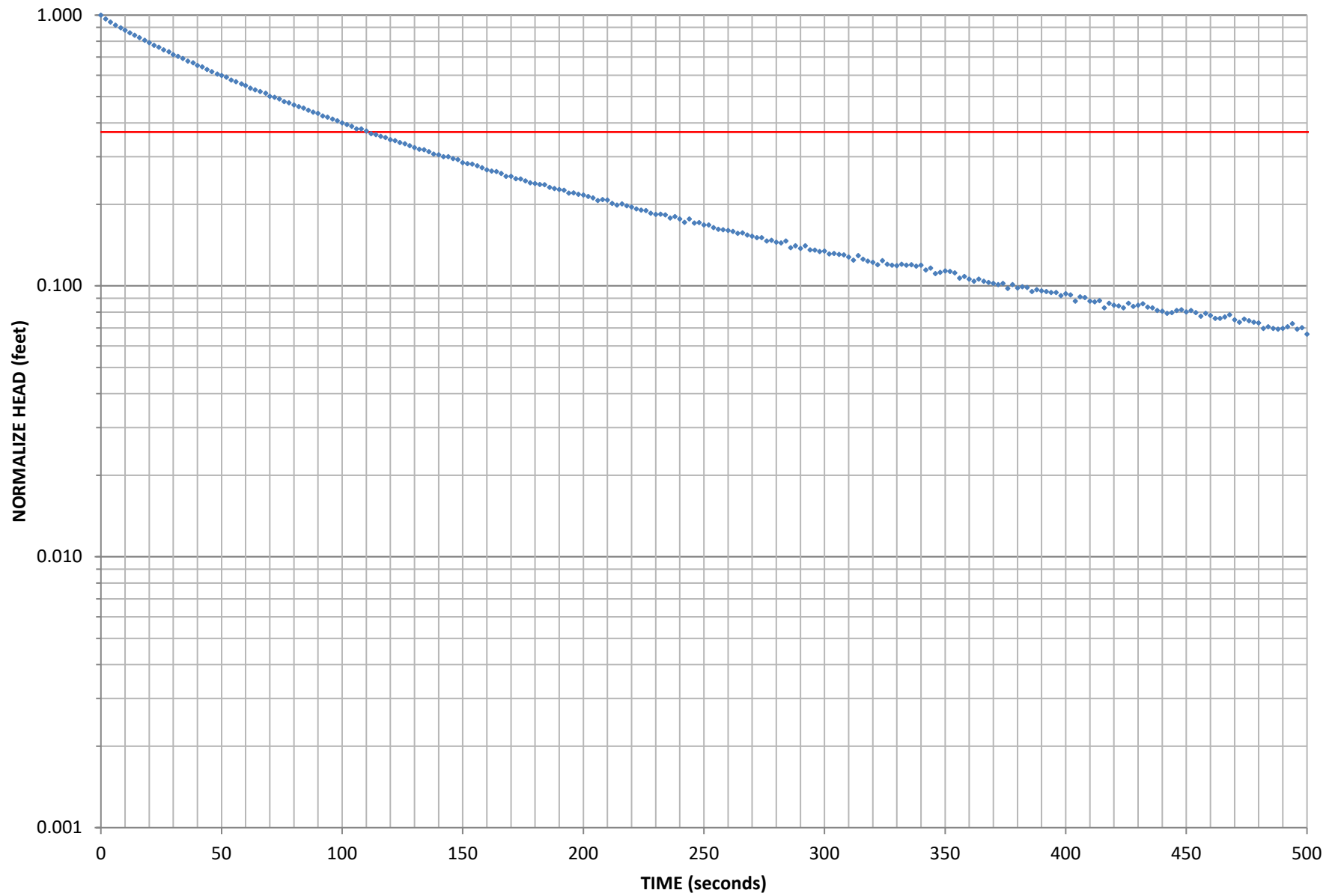
PZ-02S RISING HEAD SLUG TEST



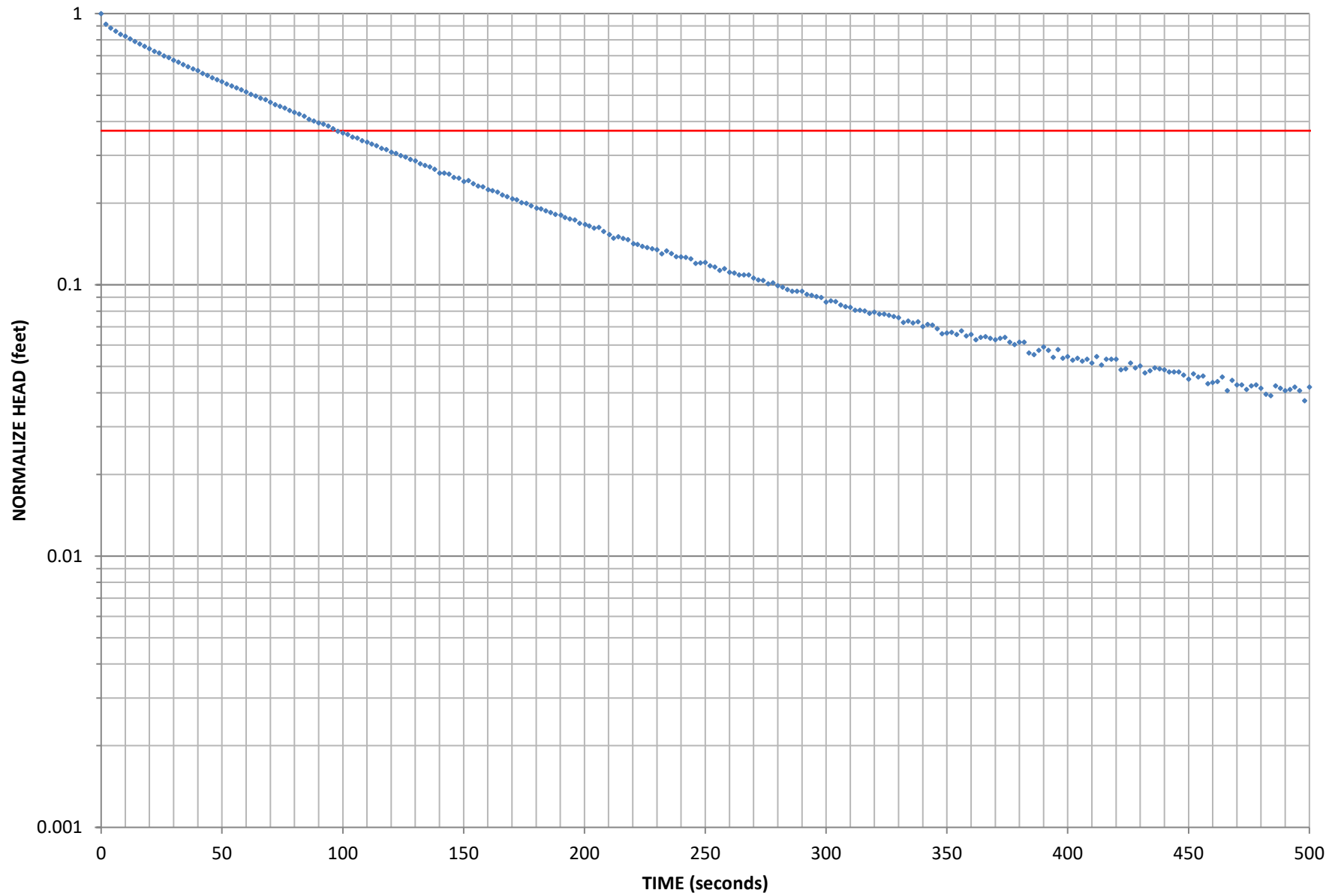
LYKES RANCH PZ-02D PERMEABILITY SLUG TEST



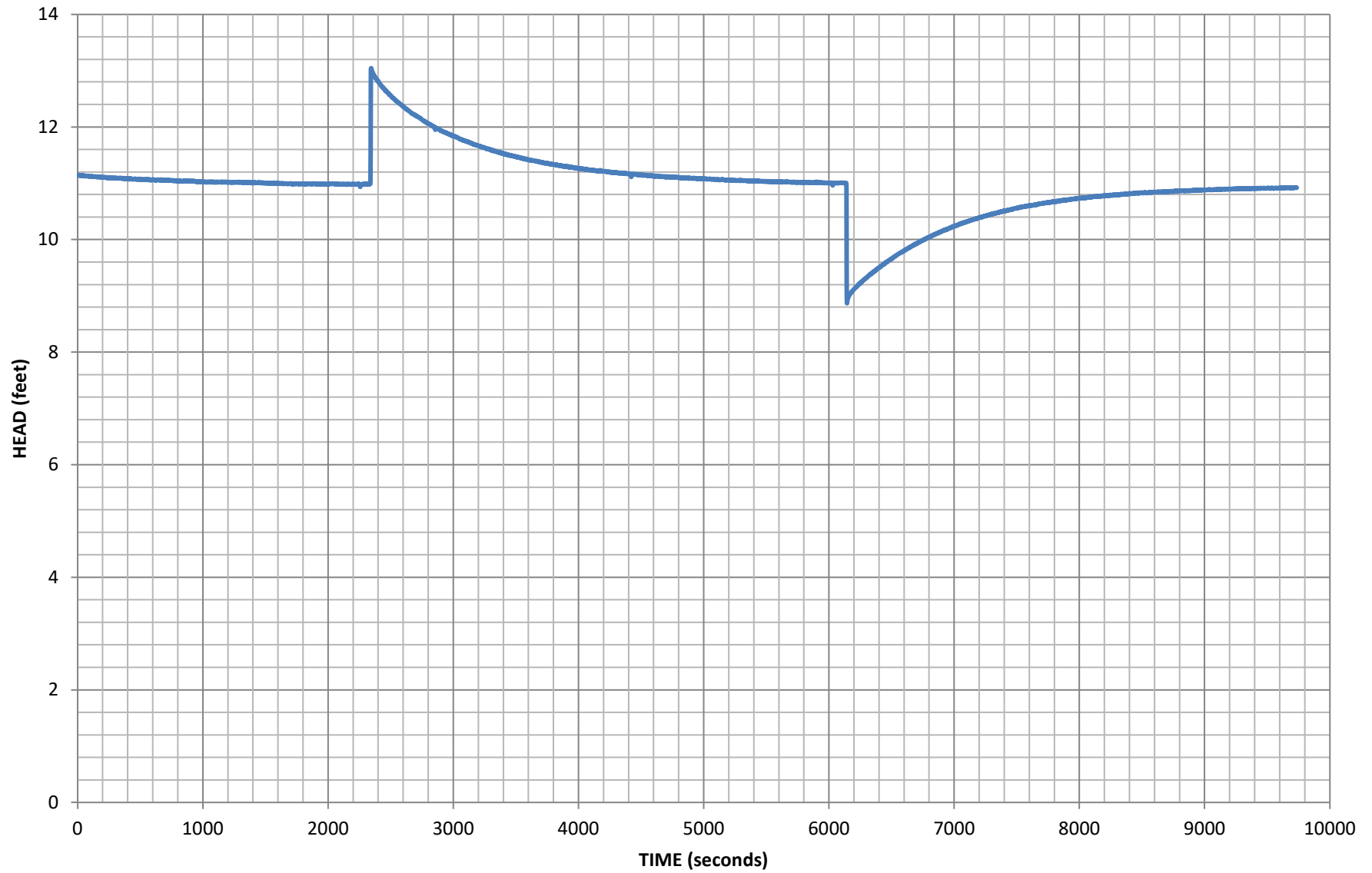
PZ-02D FALLING HEAD SLUG TEST



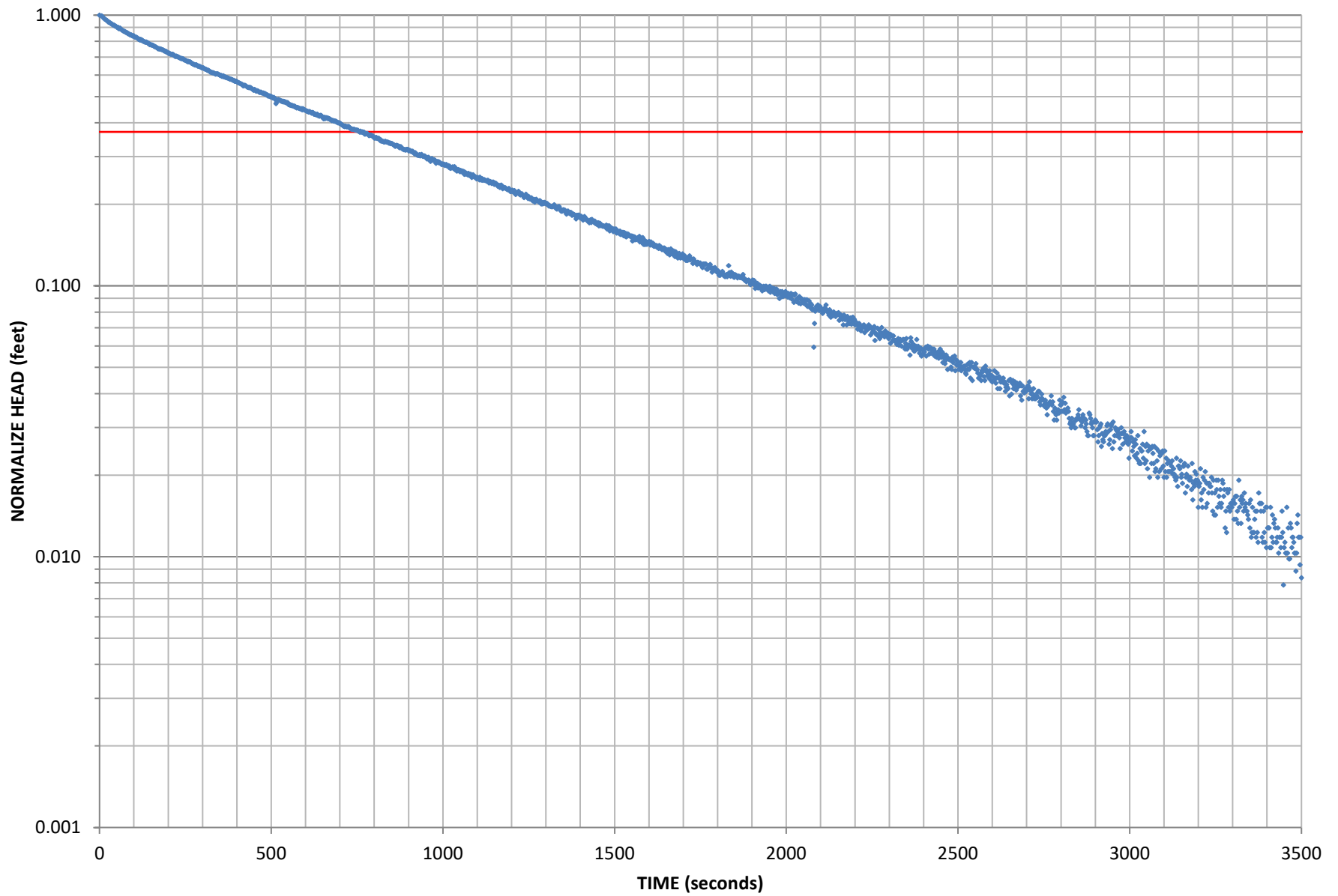
PZ-02D RISING HEAD SLUG TEST



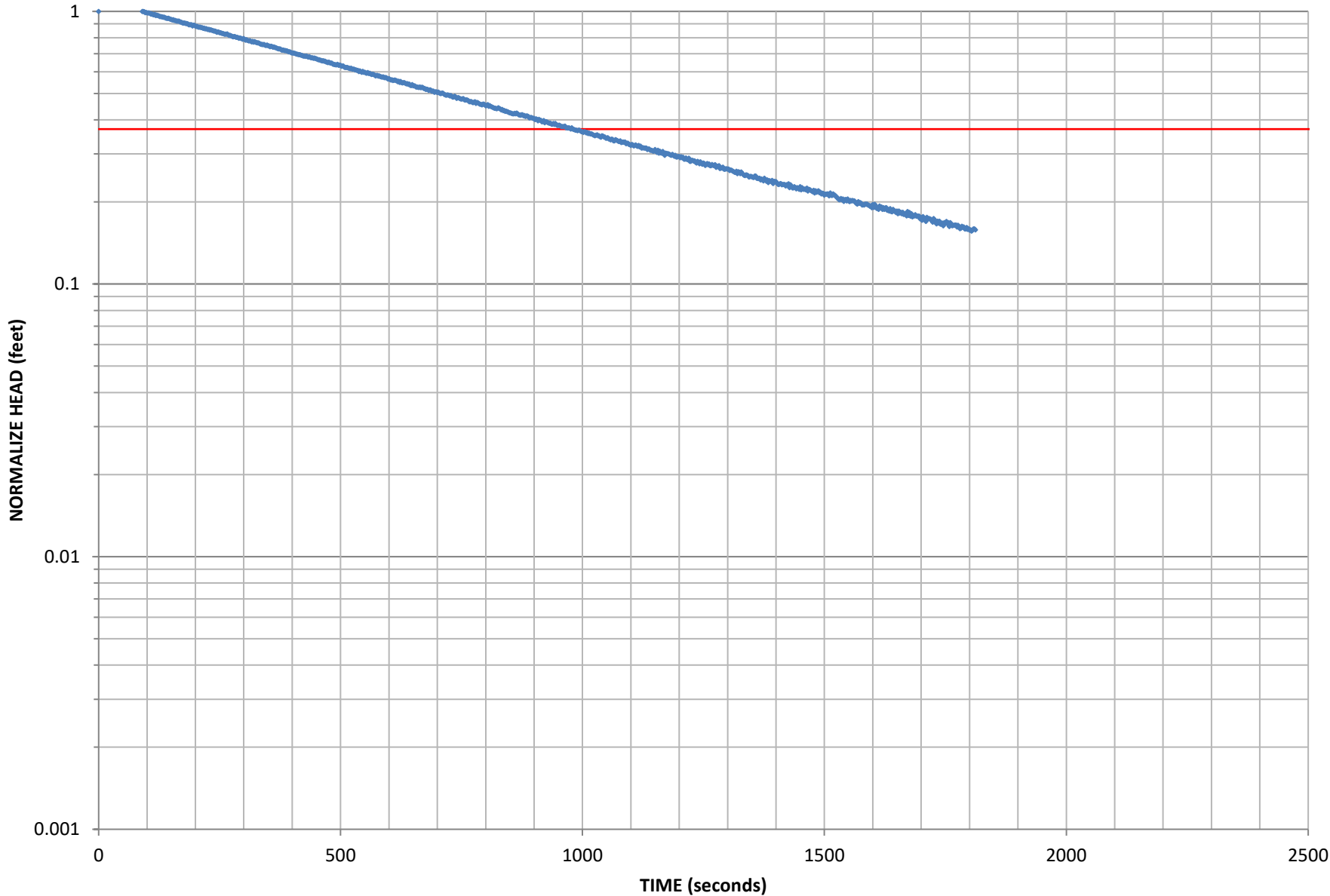
LYKES RANCH PZ-03S PERMEABILITY SLUG TEST



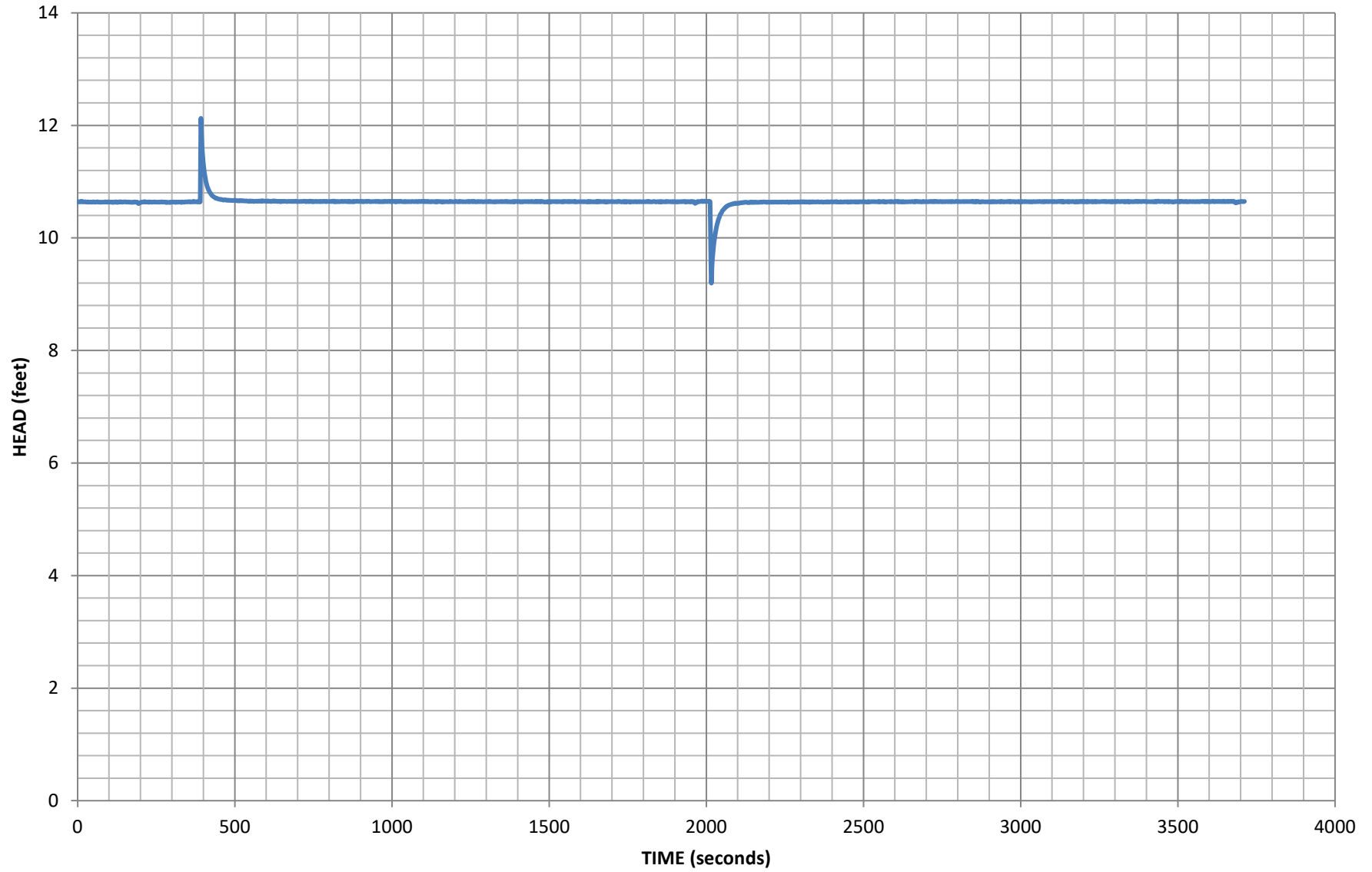
PZ-03S FALLING HEAD SLUG TEST



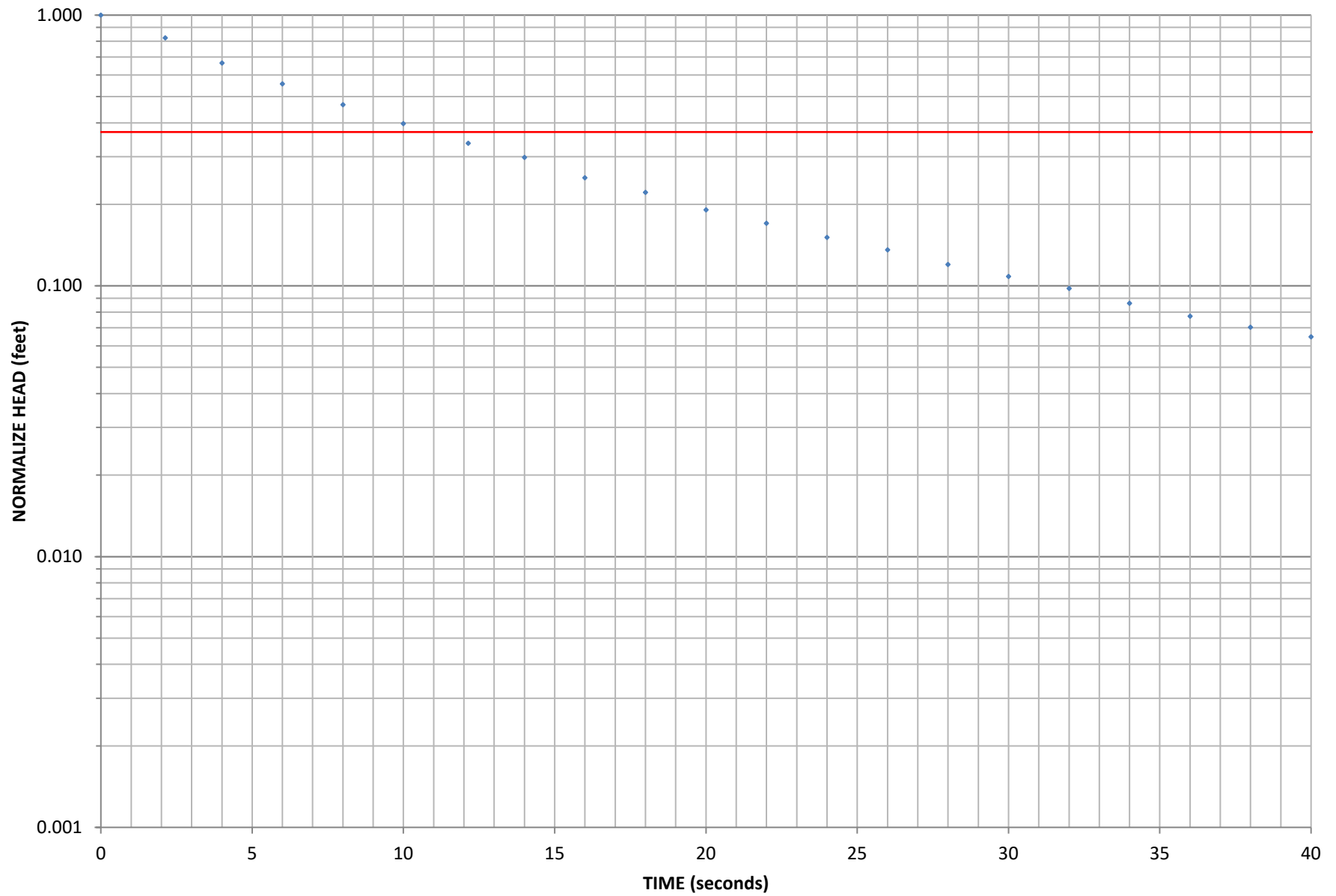
PZ-03S RISING HEAD SLUG TEST



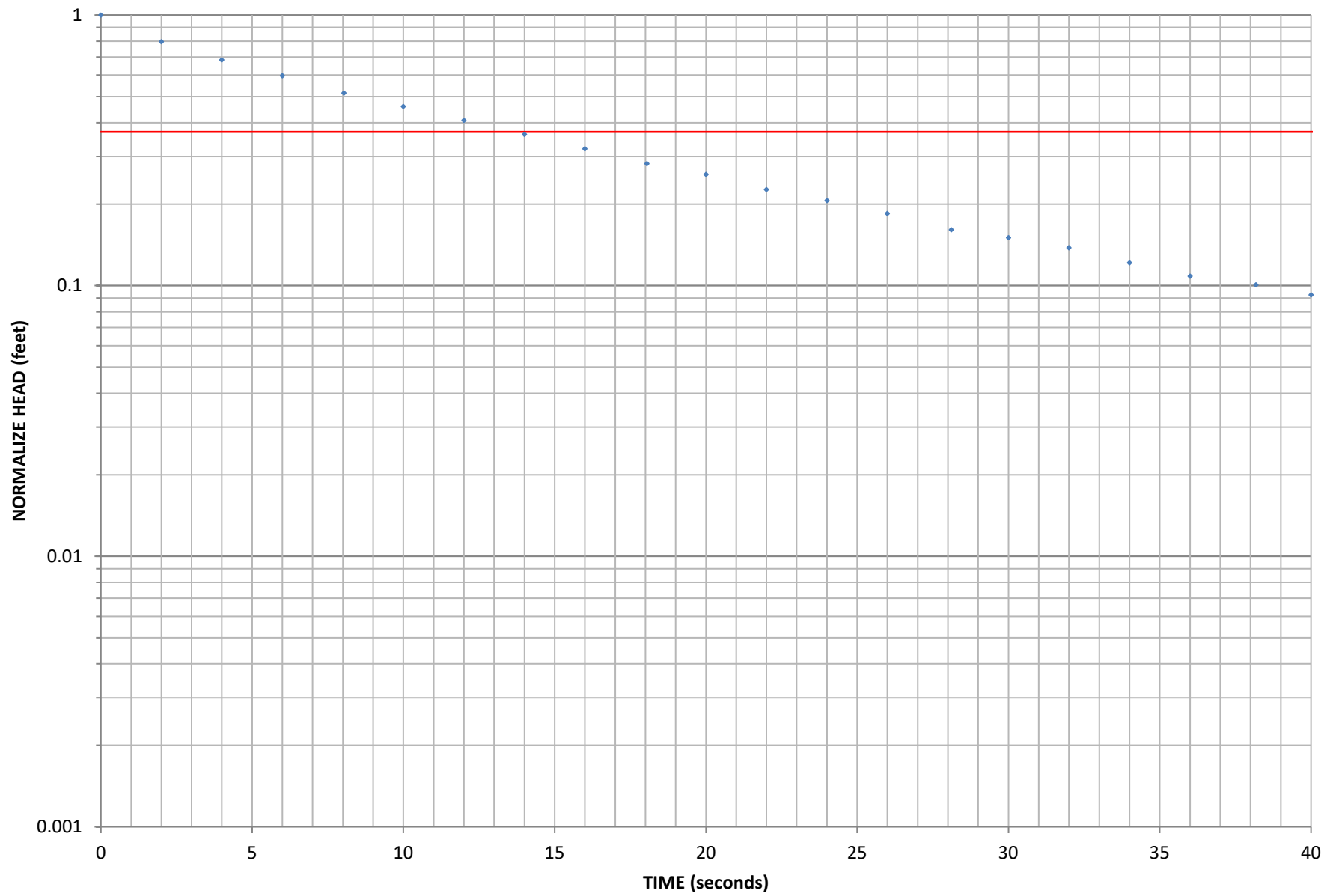
LYKES RANCH PZ-03S PERMEABILITY SLUG TEST



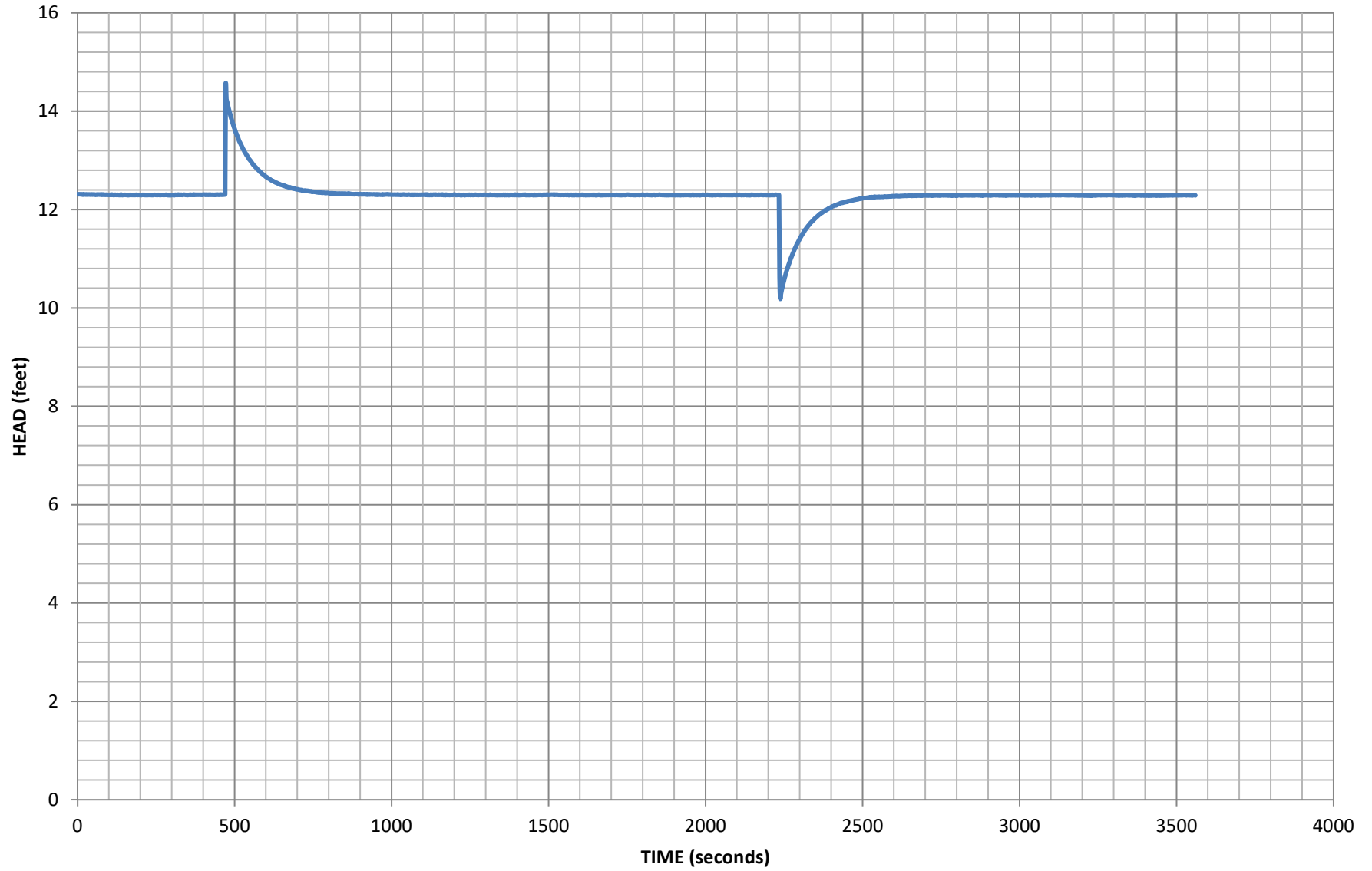
PZ-03D FALLING HEAD SLUG TEST



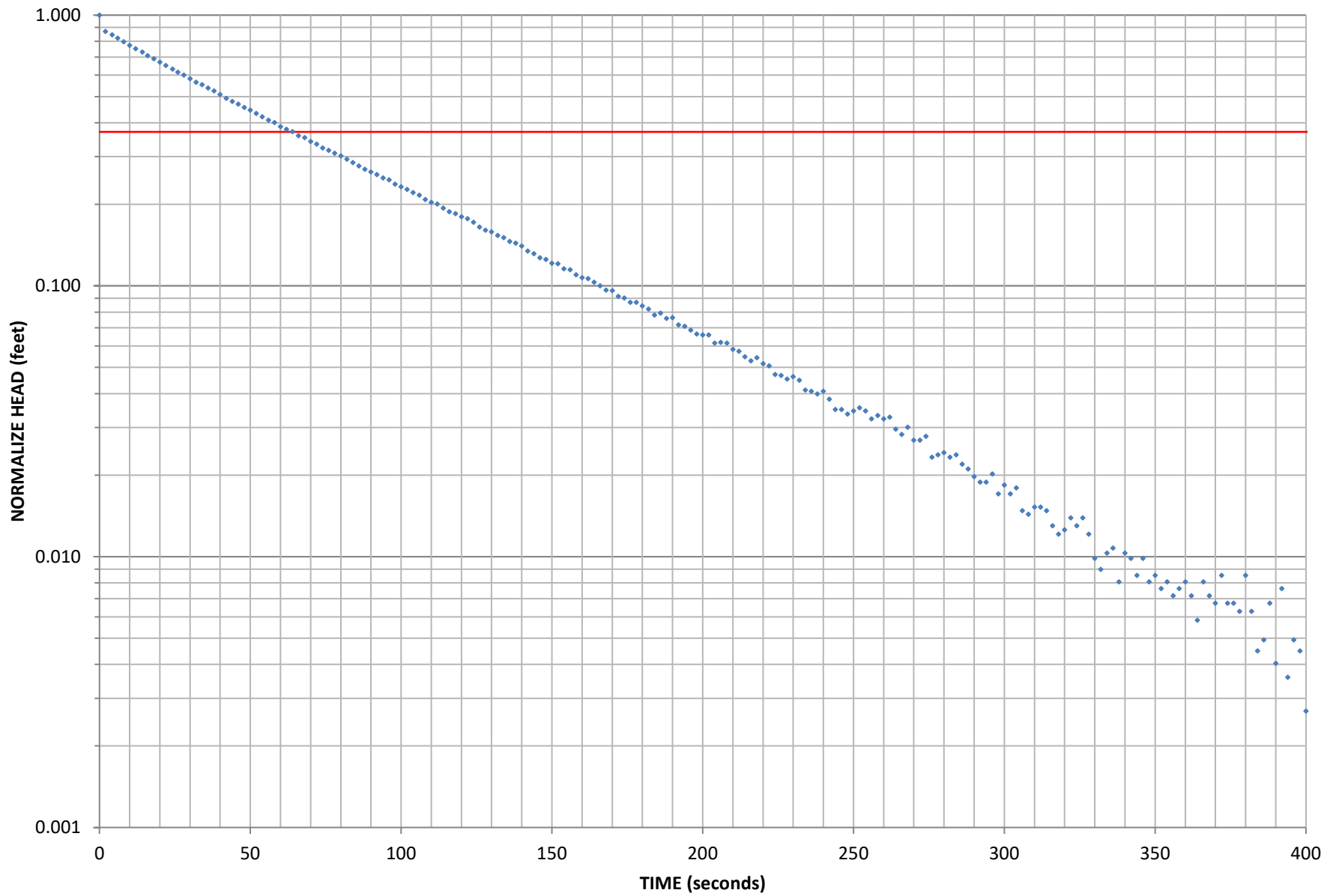
PZ-03D RISING HEAD SLUG TEST



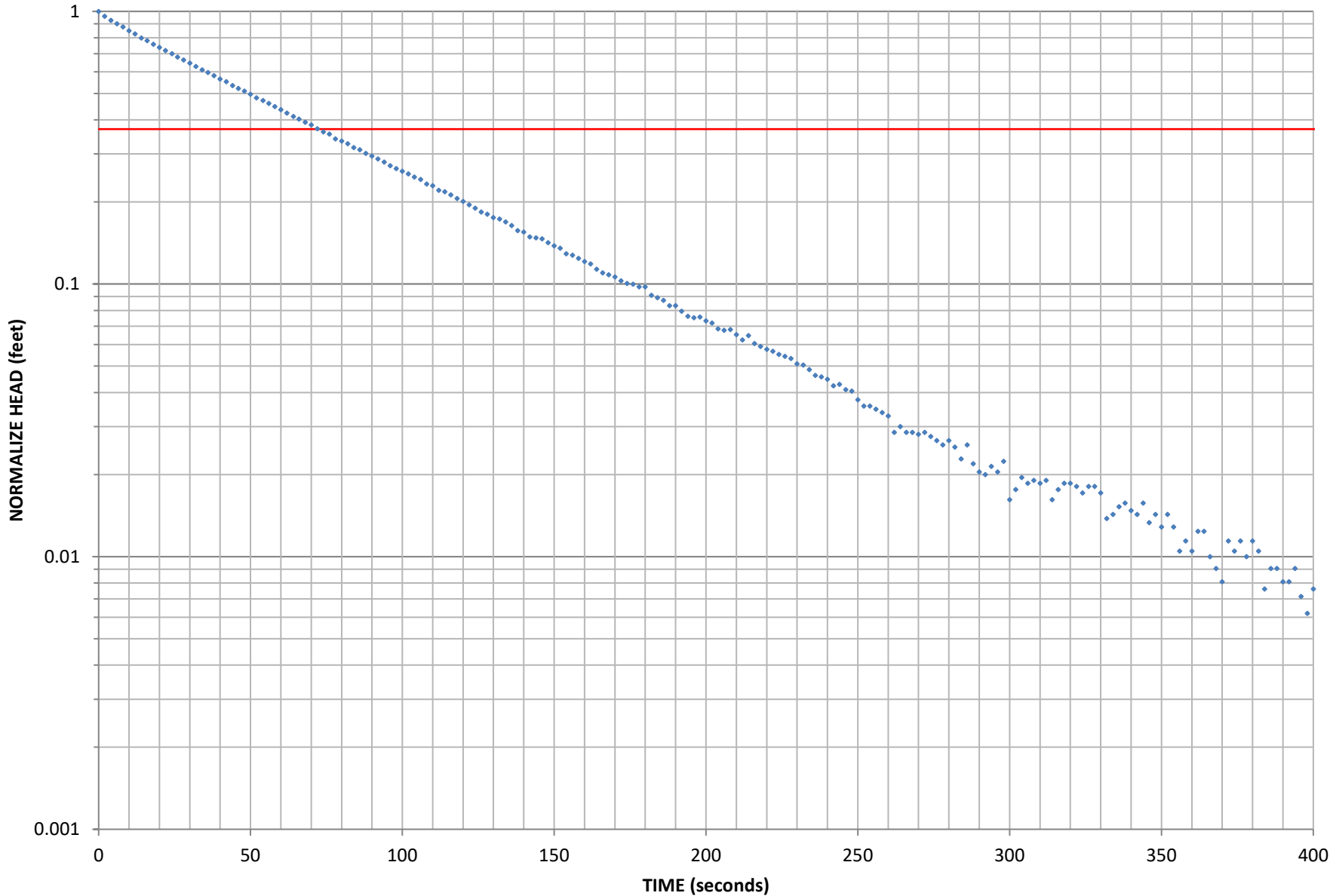
LYKES RANCH PZ-04S PERMEABILITY SLUG TEST



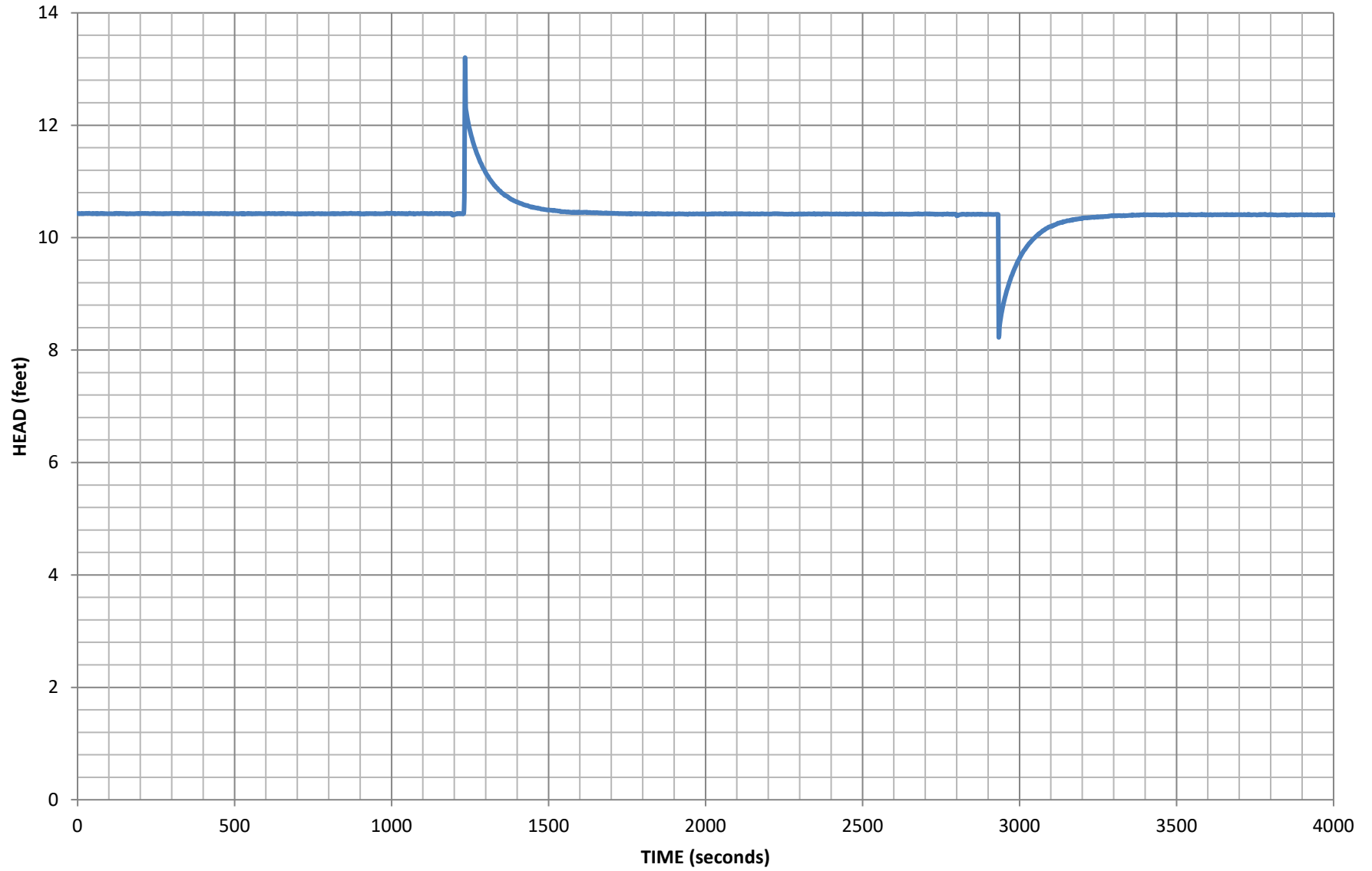
PZ-04S FALLING HEAD SLUG TEST



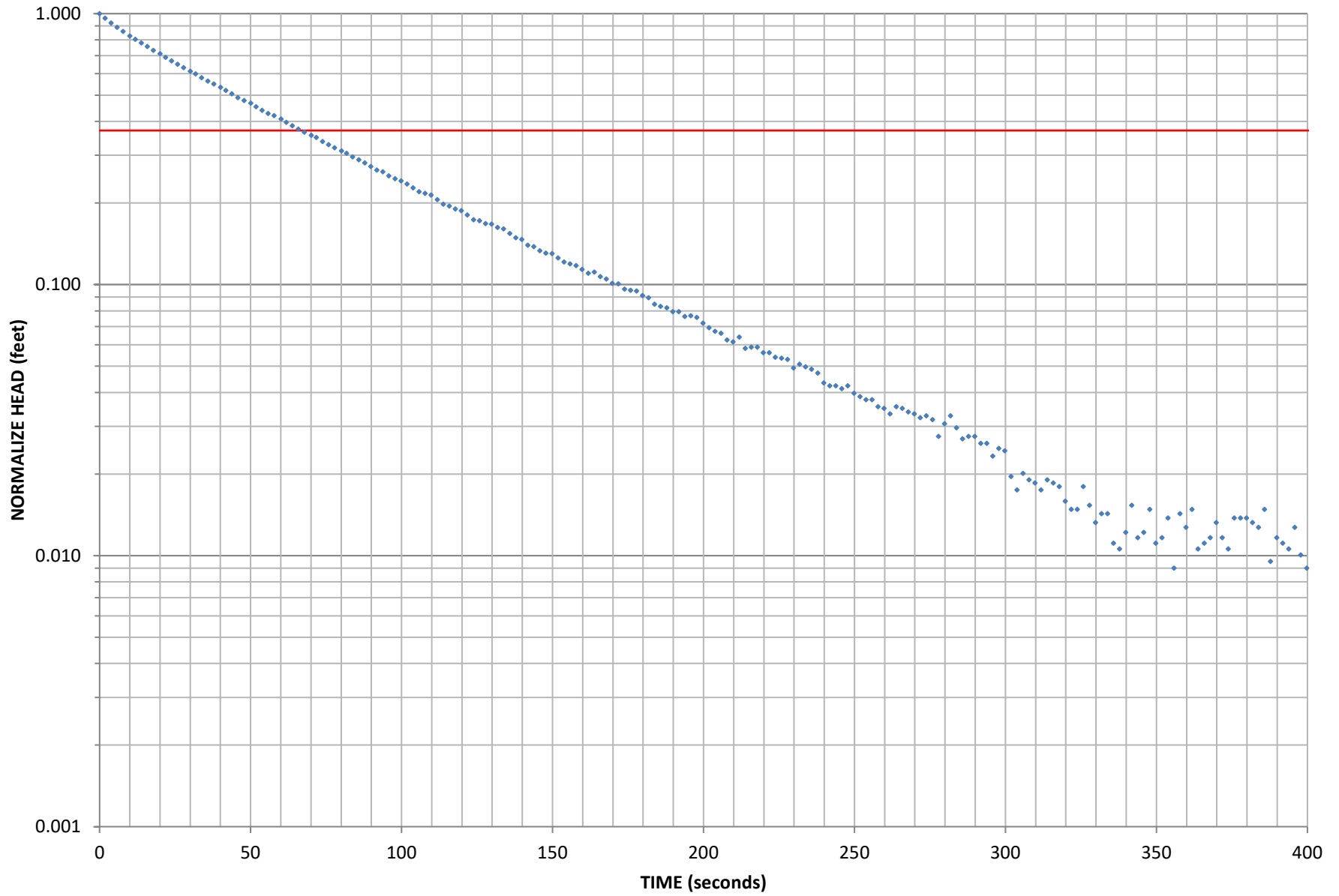
PZ-04S RISING HEAD SLUG TEST



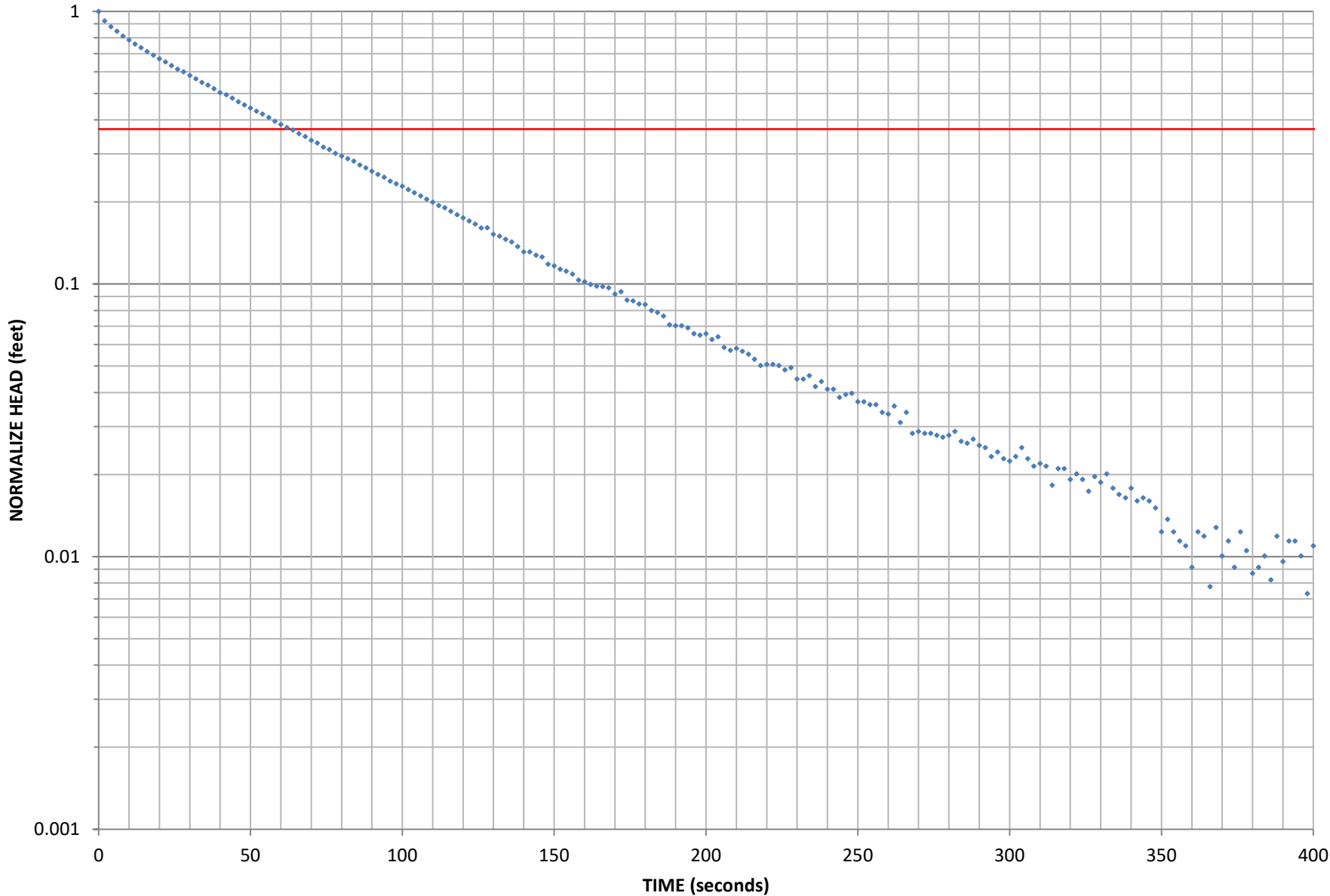
LYKES RANCH PZ-05S PERMEABILITY SLUG TEST



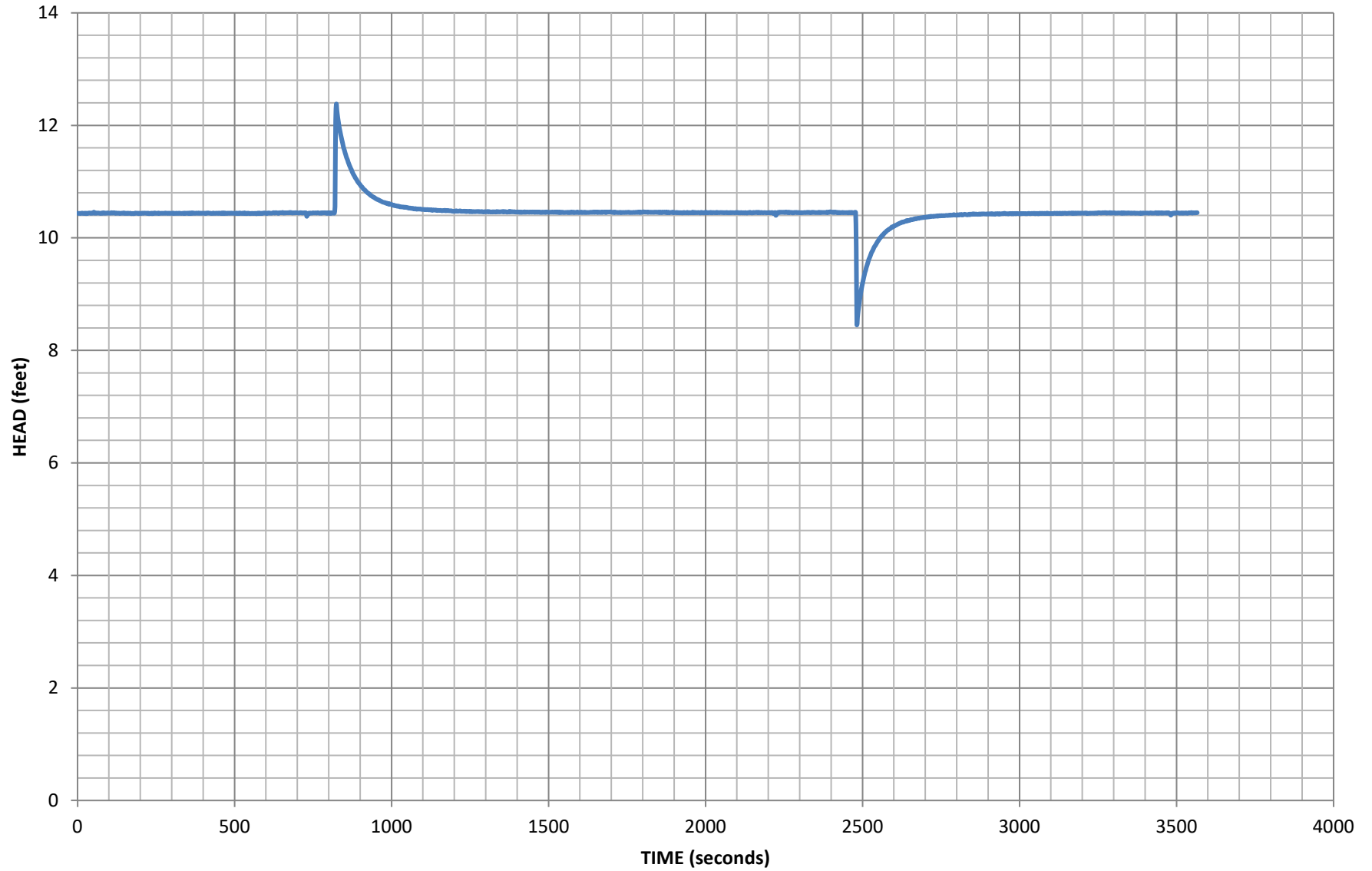
PZ-05S FALLING HEAD SLUG TEST



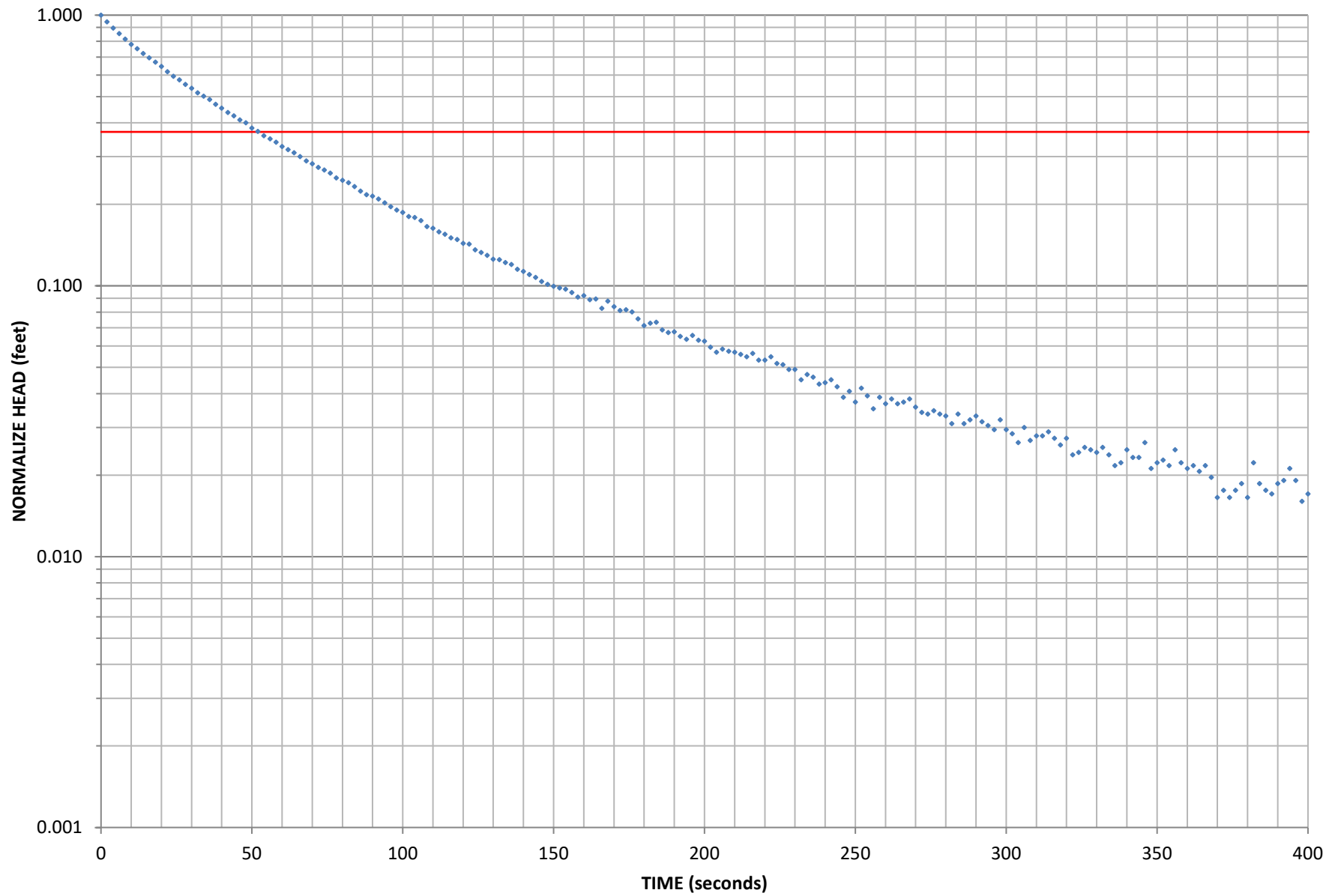
PZ-05S RISING HEAD SLUG TEST



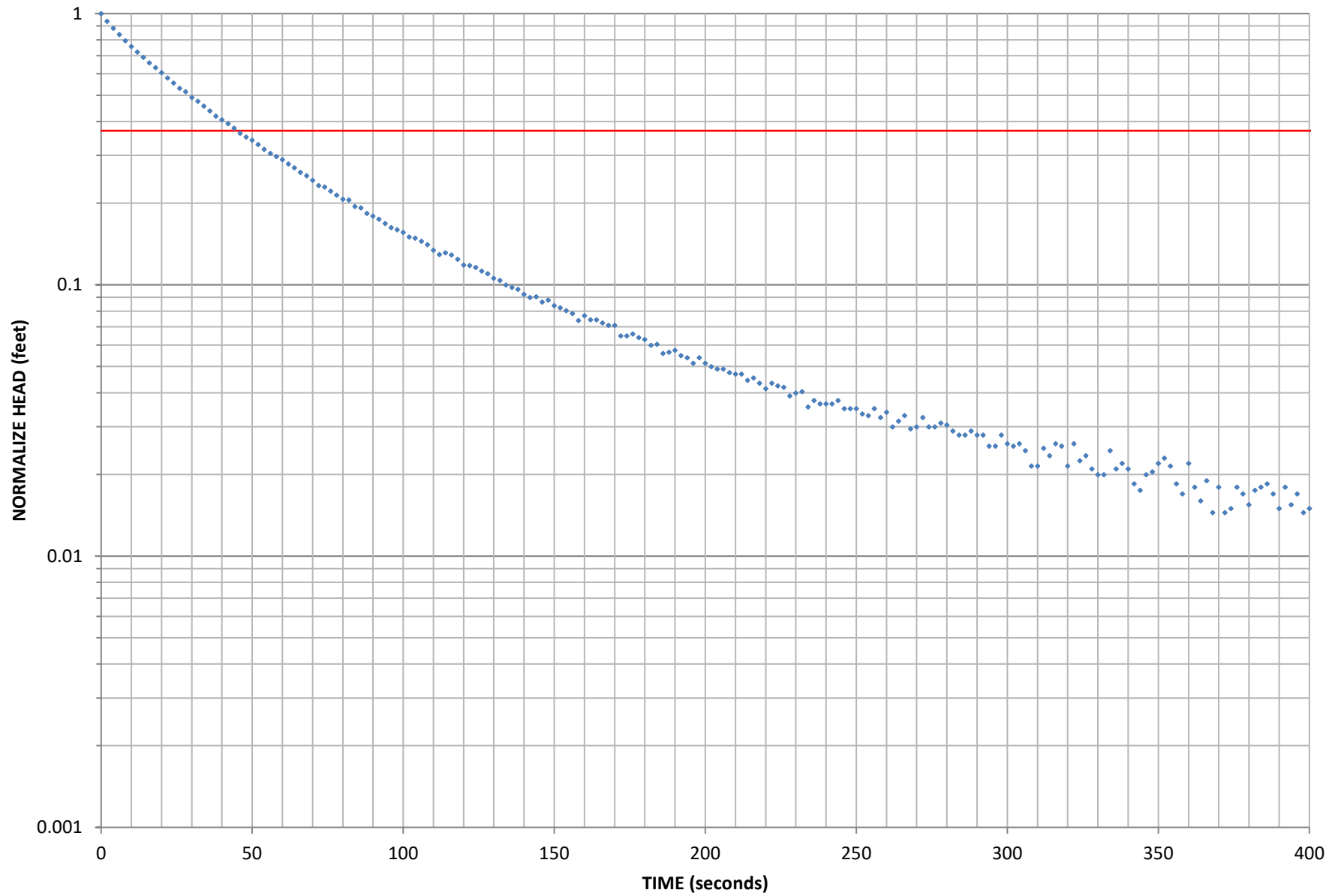
LYKES RANCH PZ-05S PERMEABILITY SLUG TEST



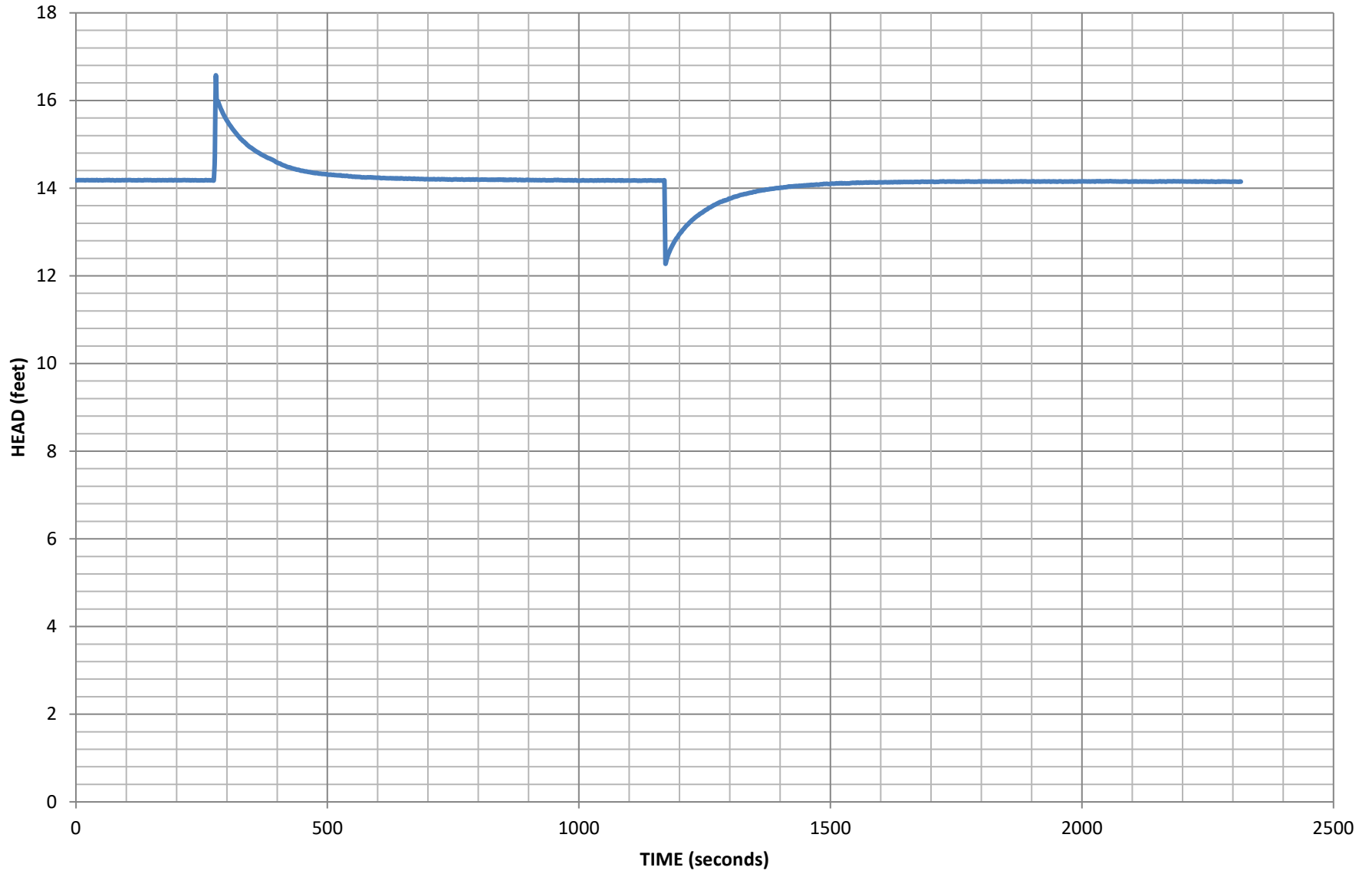
PZ-05D FALLING HEAD SLUG TEST



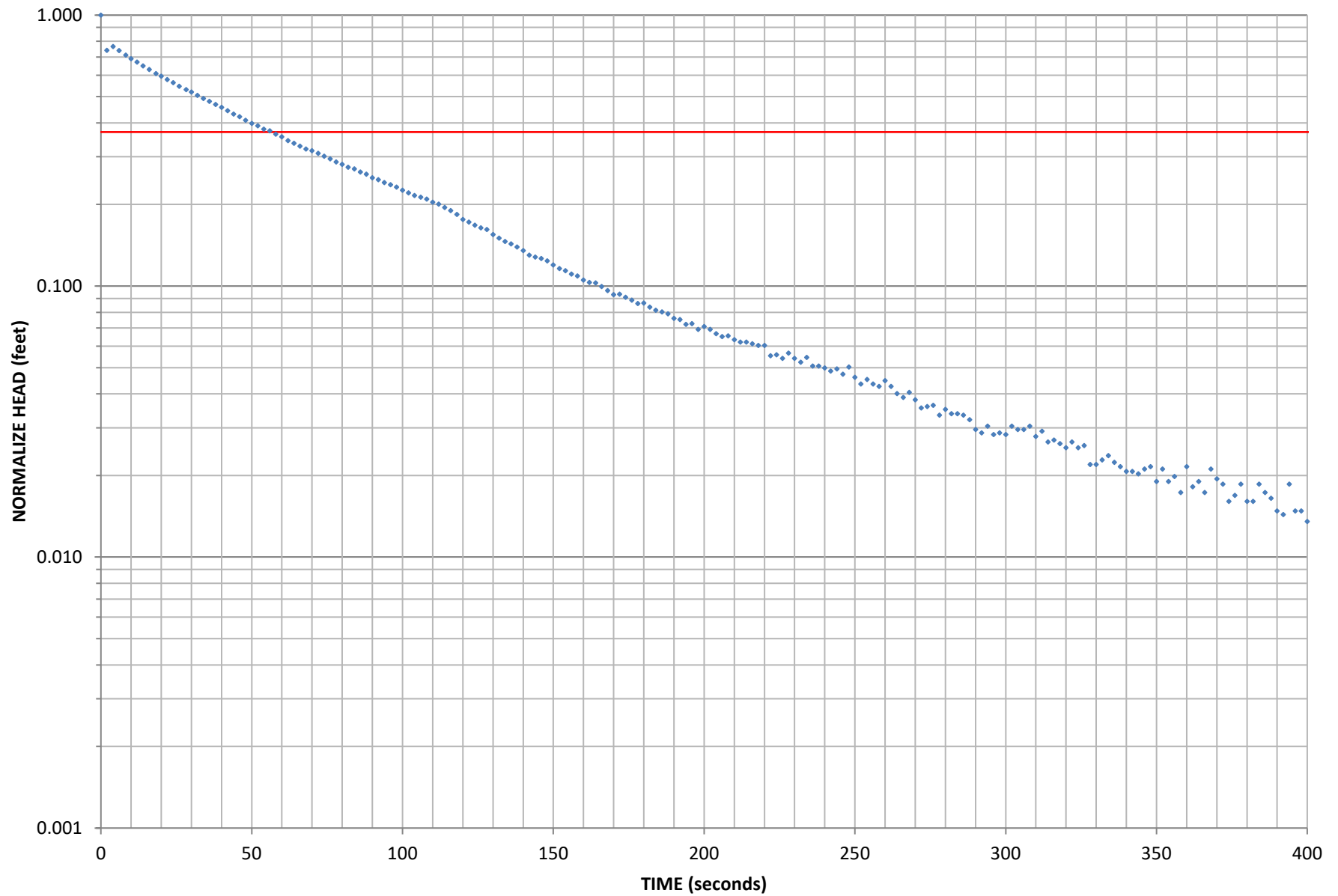
PZ-05D RISING HEAD SLUG TEST



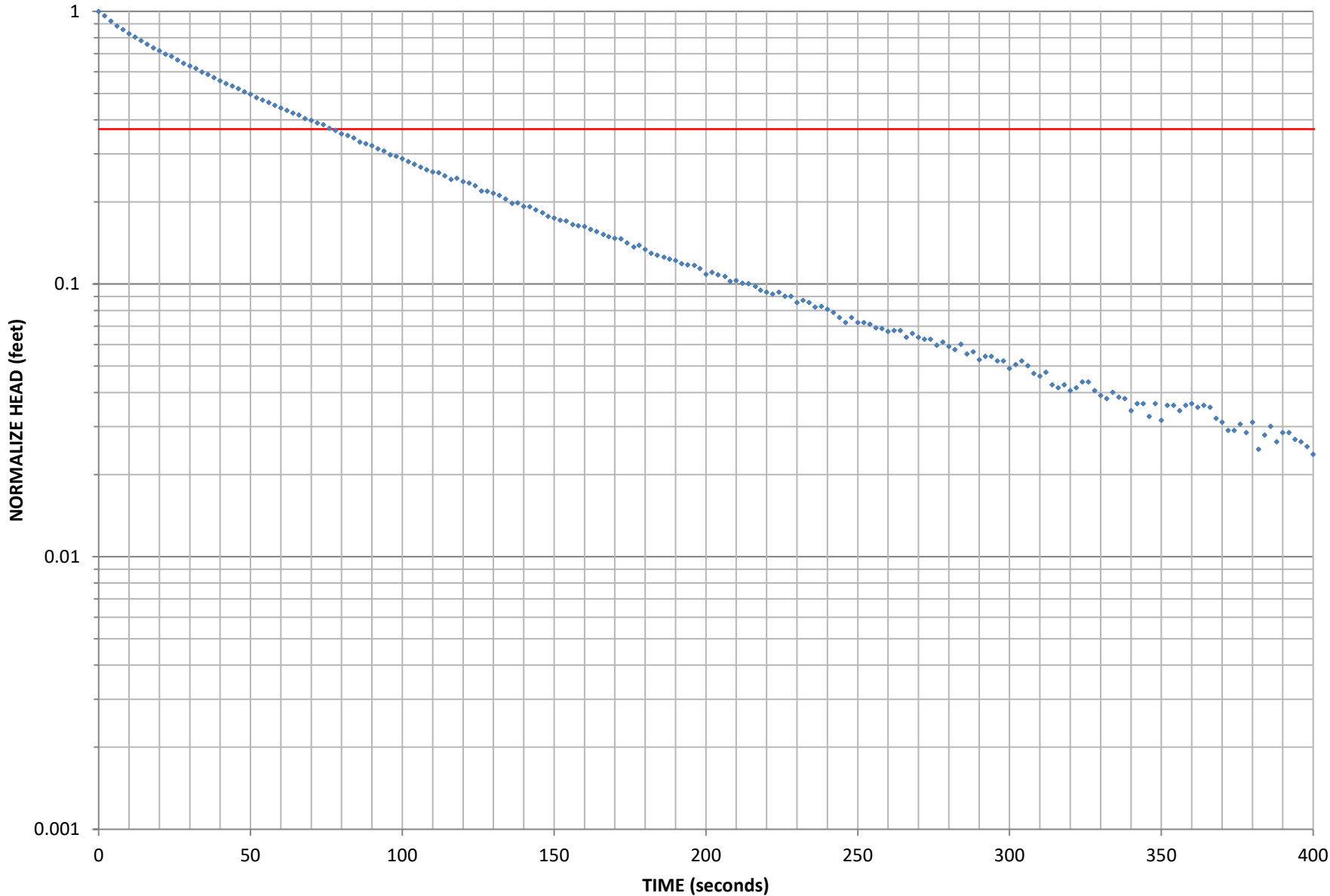
LYKES RANCH PZ-06S PERMEABILITY SLUG TEST



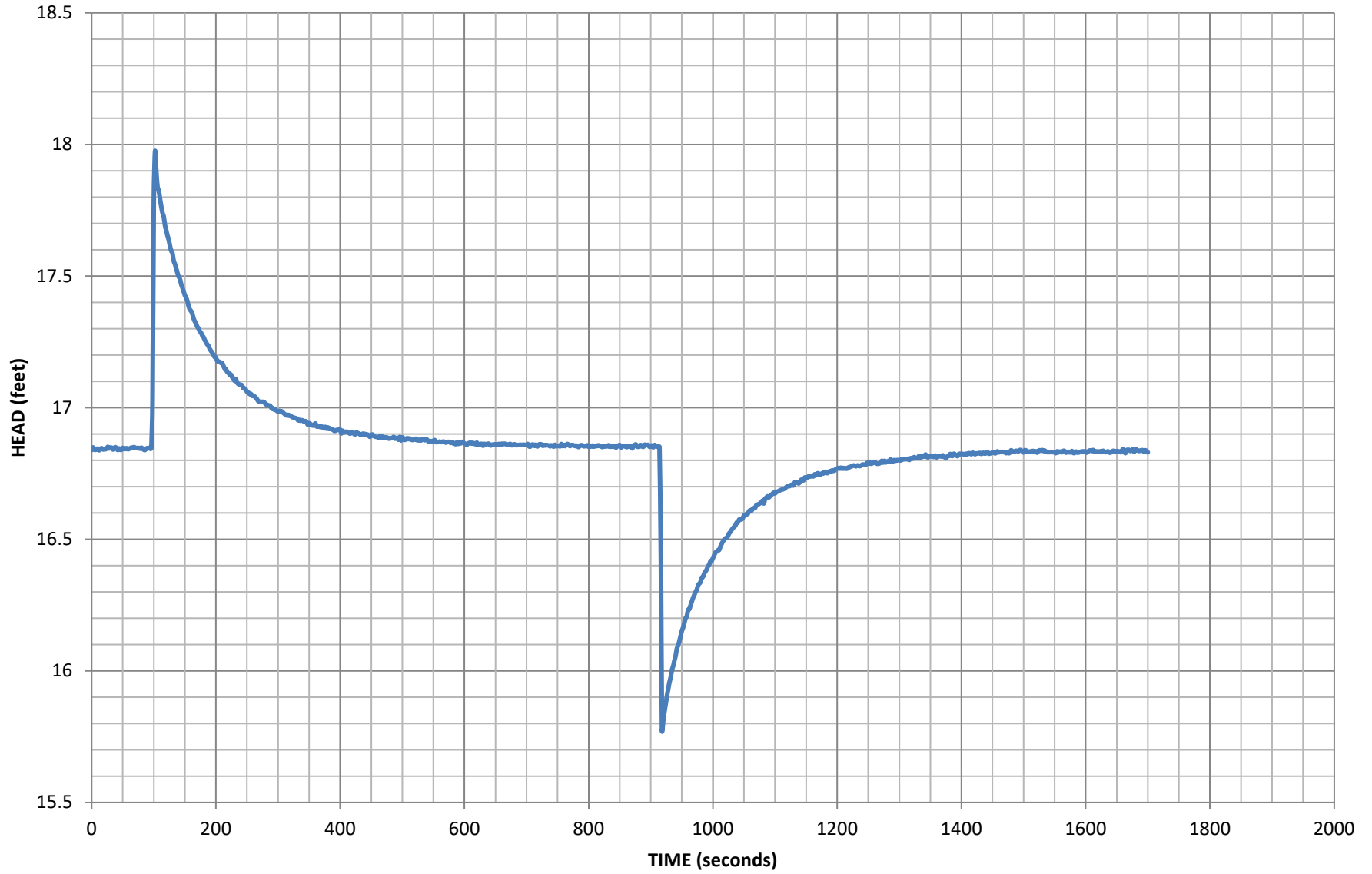
PZ-06S FALLING HEAD SLUG TEST



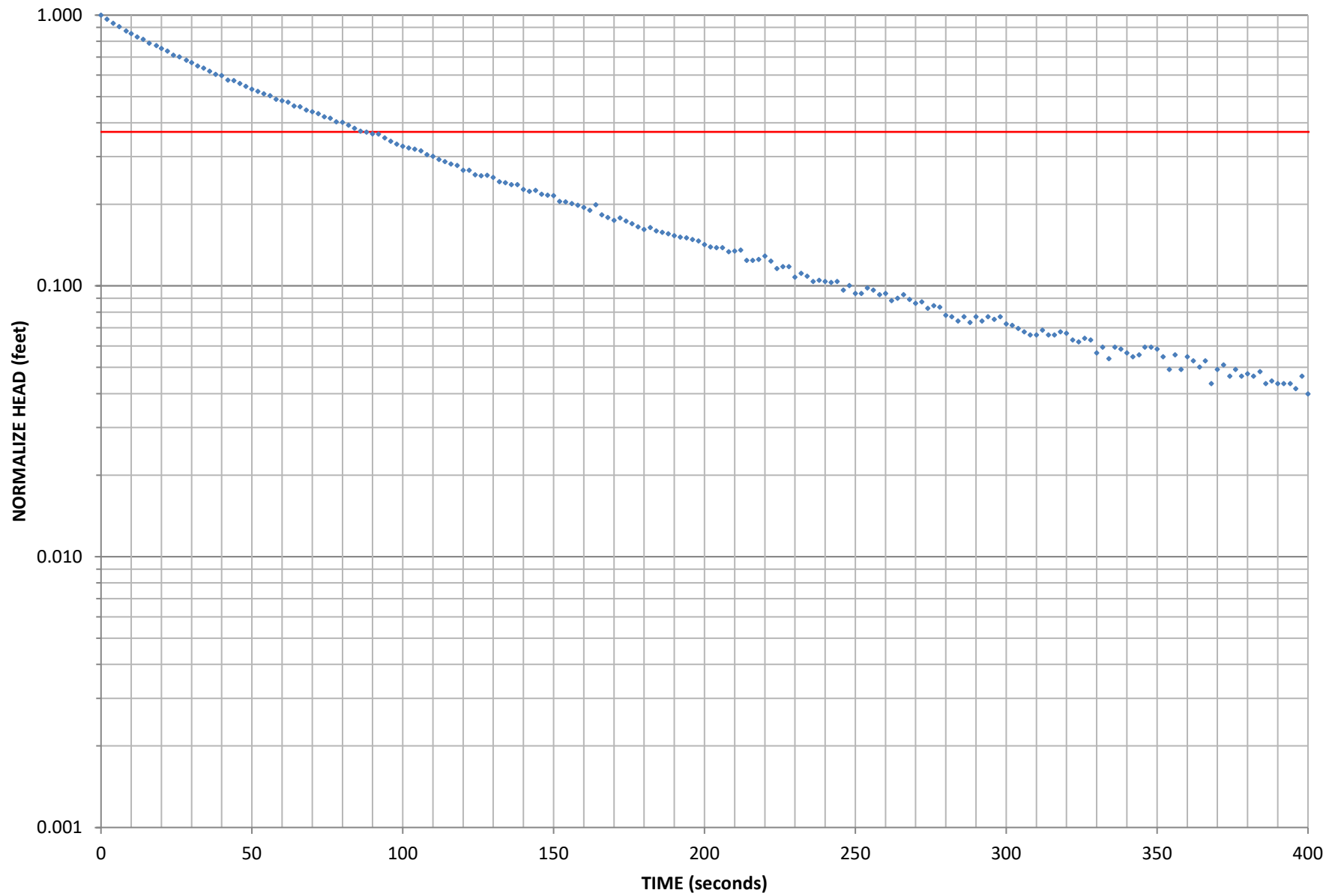
PZ-06S RISING HEAD SLUG TEST



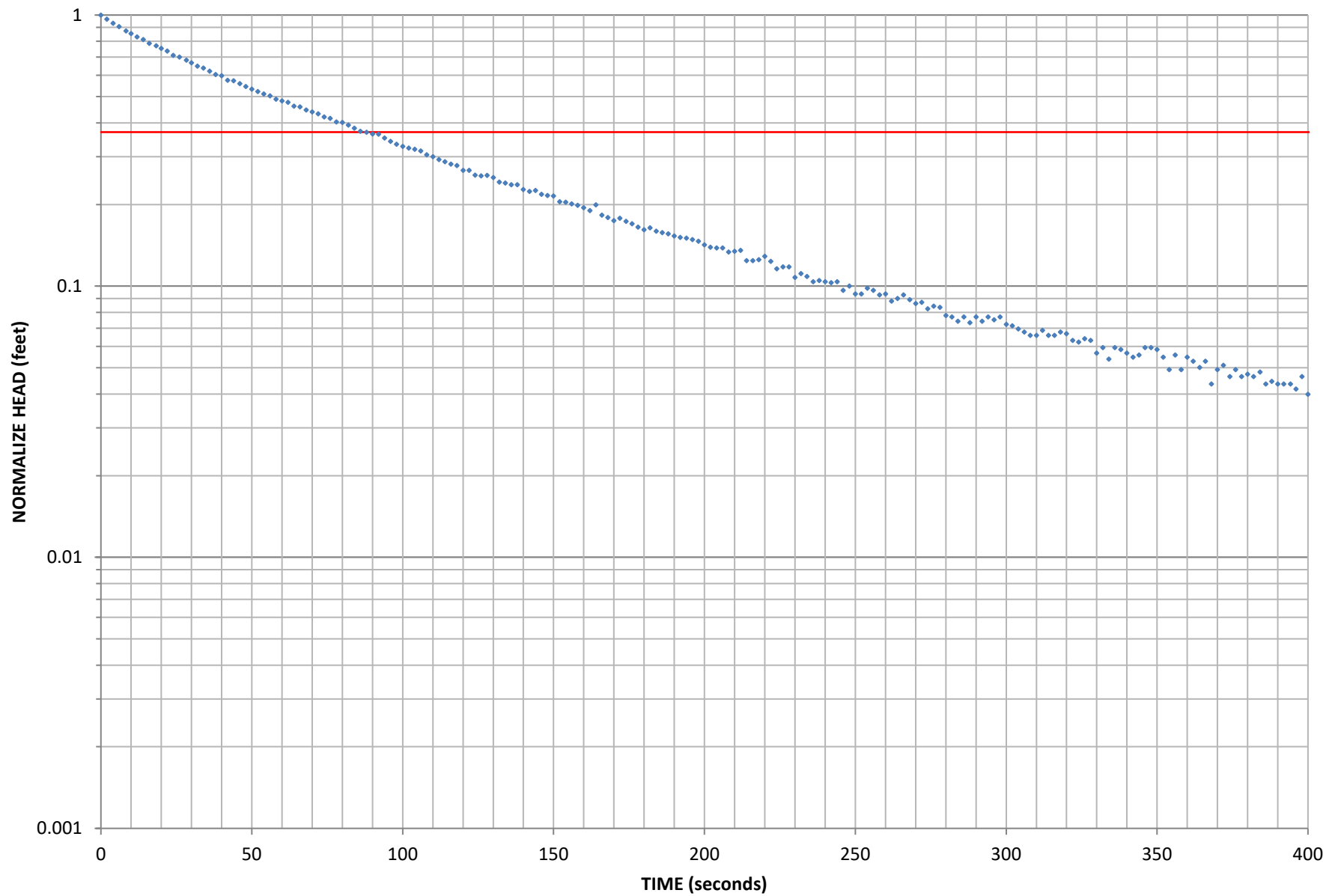
LYKES RANCH PZ-06D PERMEABILITY SLUG TEST



PZ-06D FALLING HEAD SLUG TEST



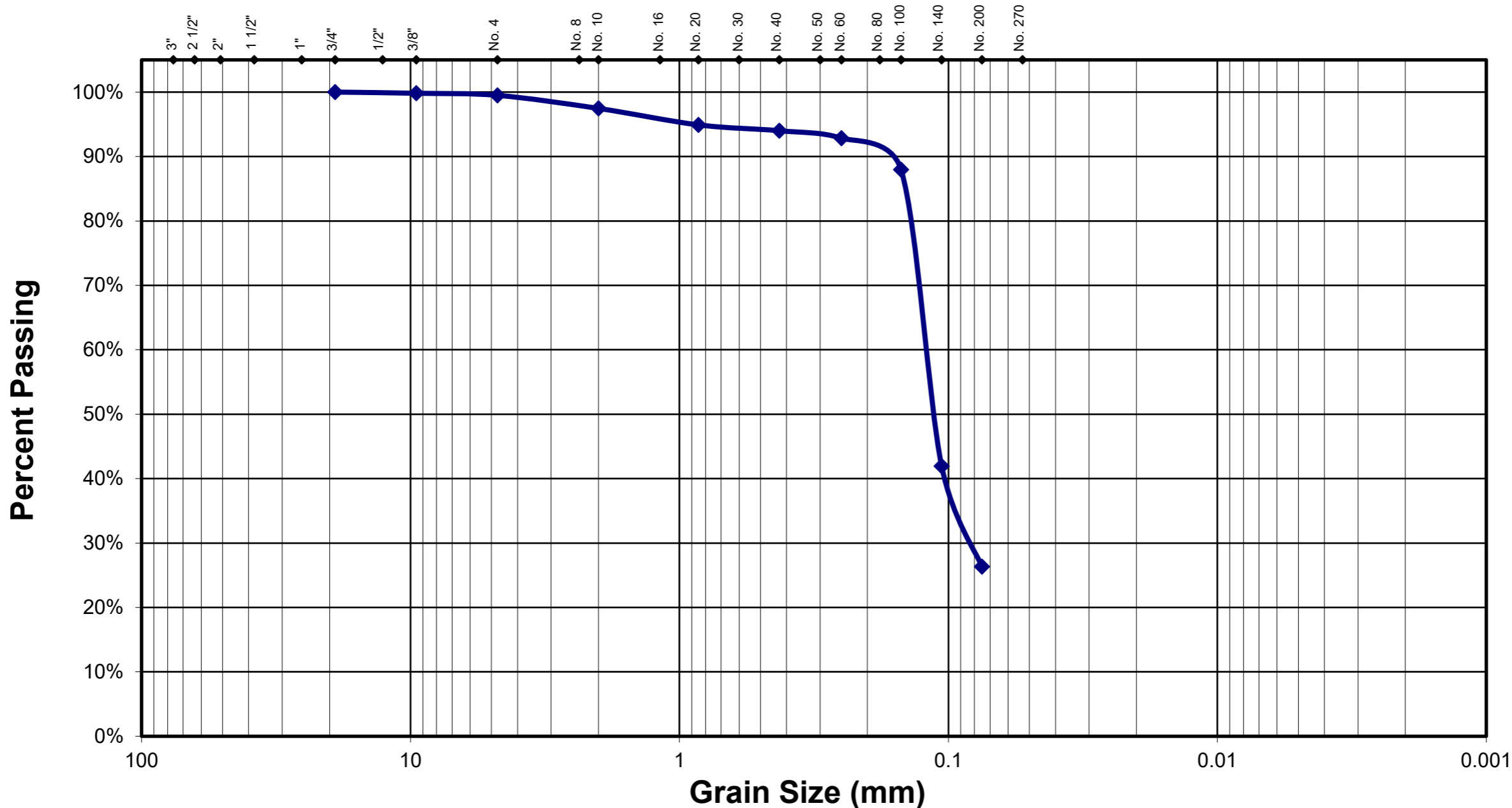
PZ-06D RISING HEAD SLUG TEST



APPENDIX IV

Grain Size Distribution Curves

GRAIN SIZE DISTRIBUTION CURVE



GRAVEL	SAND		SILT	CLAY
	Coarse to Medium	Fine		

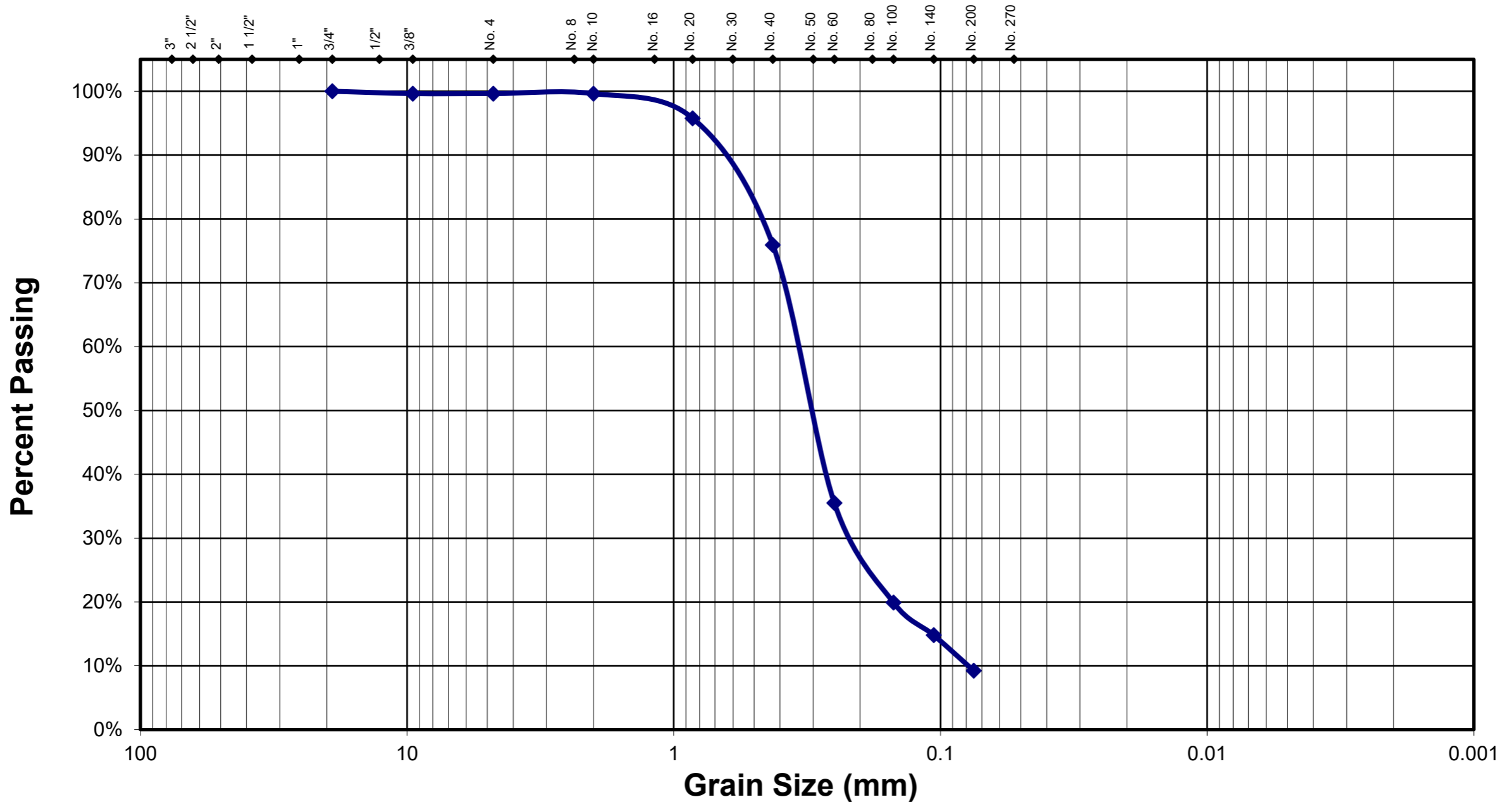
Project Name: LOCAR **A&A File Number:** 23-6363
Project Location: Lake Okechobee, Highlands County, Florida
Client Name: Tetra Tech

Boring: B-02 **Sample Depth (ft):** 61.5 - 62
Sample Description: SM - Gray silty fine sand with trace shell and trace phosphate
Percent Passing No. 200 Sieve = 26% **LL:** Not Tested **PL:** Not Tested **PI:** Not Tested



ARDAMAN & ASSOCIATES, INC.
 Geotechnical, Environmental and
 Materials Consultants

GRAIN SIZE DISTRIBUTION CURVE



GRAVEL	SAND	SILT	CLAY
	Coarse to Medium		
	Fine		

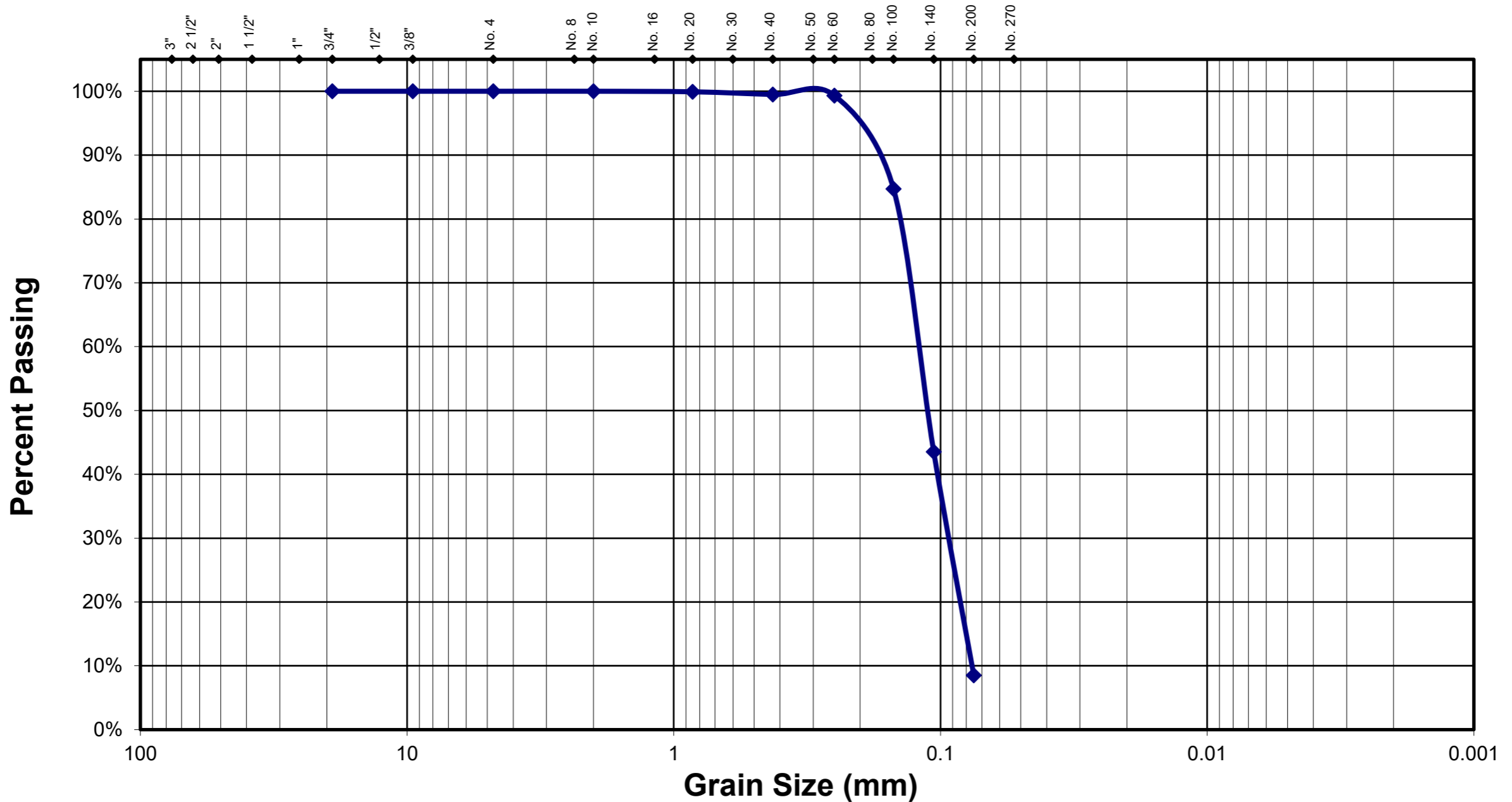
Project Name: LOCAR **A&A File Number:** 23-6363
Project Location: Lake Okechobee, Highlands County, Florida
Client Name: Tetra Tech

Boring: B-06 **Sample Depth (ft):** 27.5 - 30
Sample Description: SP-SM - Dark brown fine sand with silt
Percent Passing No. 200 Sieve = 9% **LL:** Not Tested **PL:** Not Tested **PI:** Not Tested



ARDAMAN & ASSOCIATES, INC.
 Geotechnical, Environmental and
 Materials Consultants

GRAIN SIZE DISTRIBUTION CURVE



GRAVEL	SAND	SILT	CLAY
	Coarse to Medium	Fine	

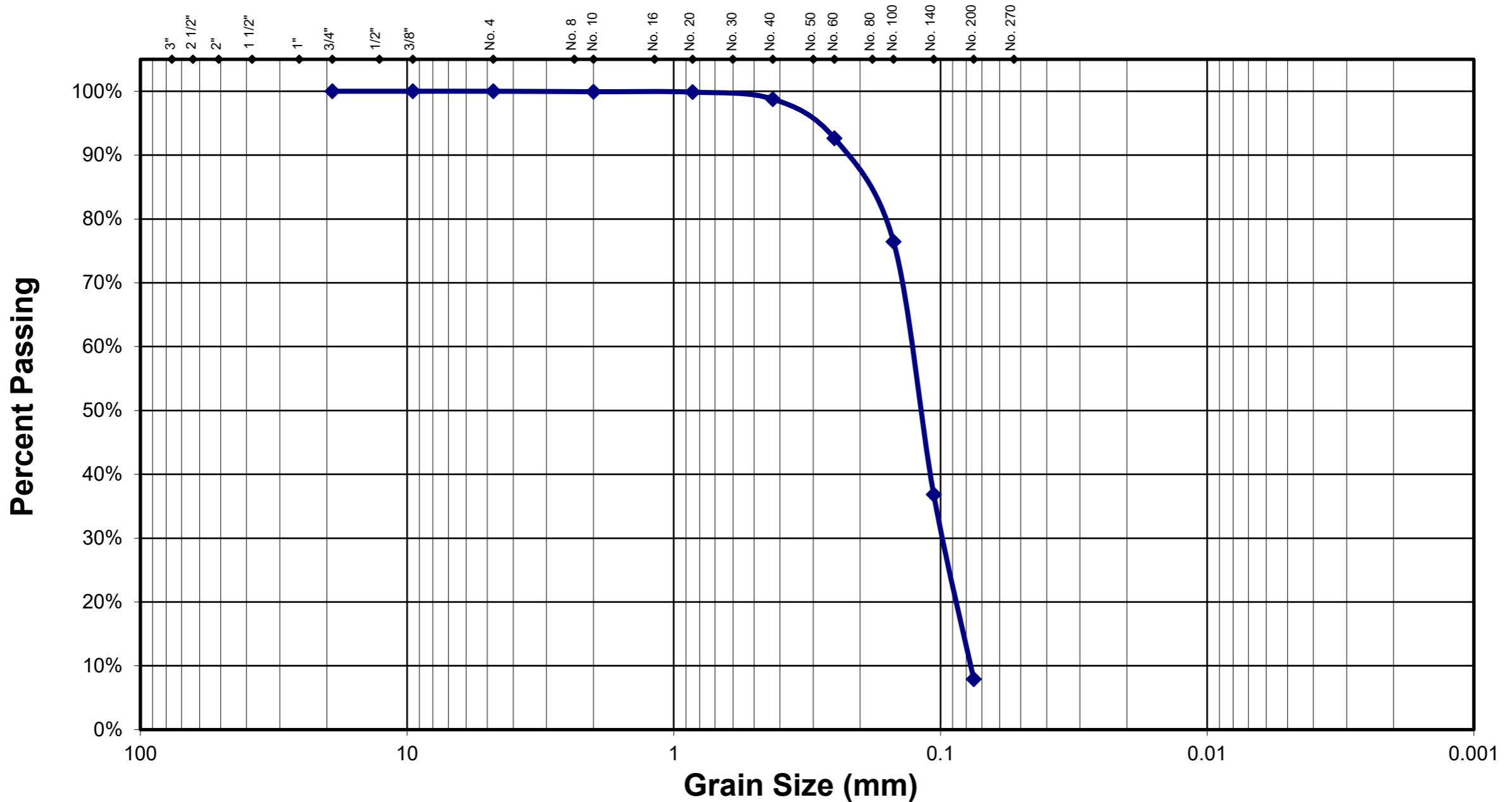
Project Name: LOCAR **A&A File Number:** 23-6363
Project Location: Lake Okechobee, Highlands County, Florida
Client Name: Tetra Tech

Boring: B-20 **Sample Depth (ft):** 0 - 1.5
Sample Description: SP-SM - Very light gray fine sand with silt
Percent Passing No. 200 Sieve = 9% **LL:** Not Tested **PL:** Not Tested **PI:** Not Tested



ARDAMAN & ASSOCIATES, INC.
 Geotechnical, Environmental and
 Materials Consultants

GRAIN SIZE DISTRIBUTION CURVE



GRAVEL	SAND	SILT	CLAY
	Coarse to Medium	Fine	

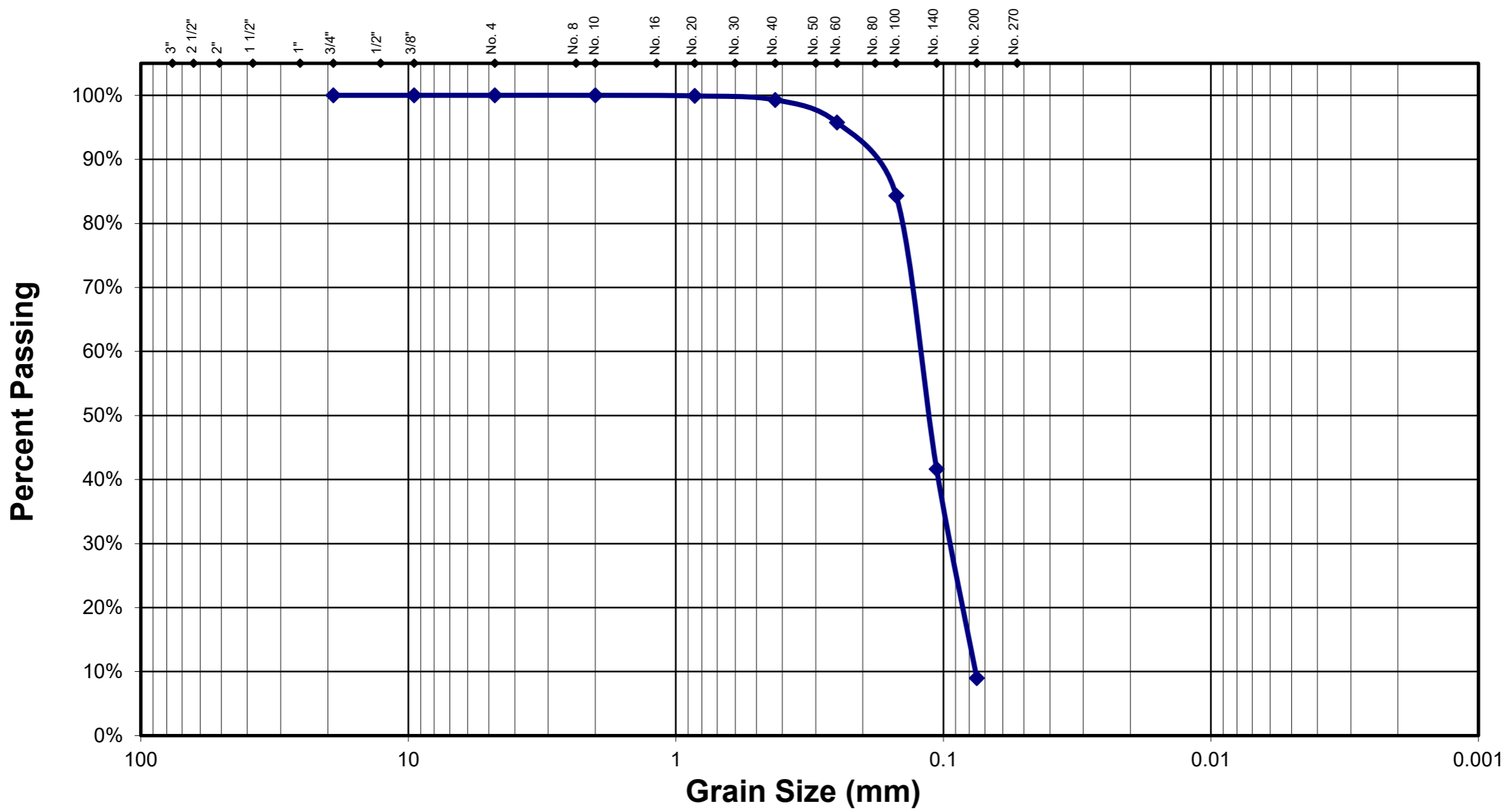
Project Name: LOCAR **A&A File Number:** 23-6363
Project Location: Lake Okechobee, Highlands County, Florida
Client Name: Tetra Tech

Boring: B-25 **Sample Depth (ft):** 0 - 1.5
Sample Description: SP-SC - Brown gray fine sand with clay
Percent Passing No. 200 Sieve = 8% **LL:** Not Tested **PL:** Not Tested **PI:** Not Tested



ARDAMAN & ASSOCIATES, INC.
 Geotechnical, Environmental and
 Materials Consultants

GRAIN SIZE DISTRIBUTION CURVE



APPENDIX V

DRI Test Results

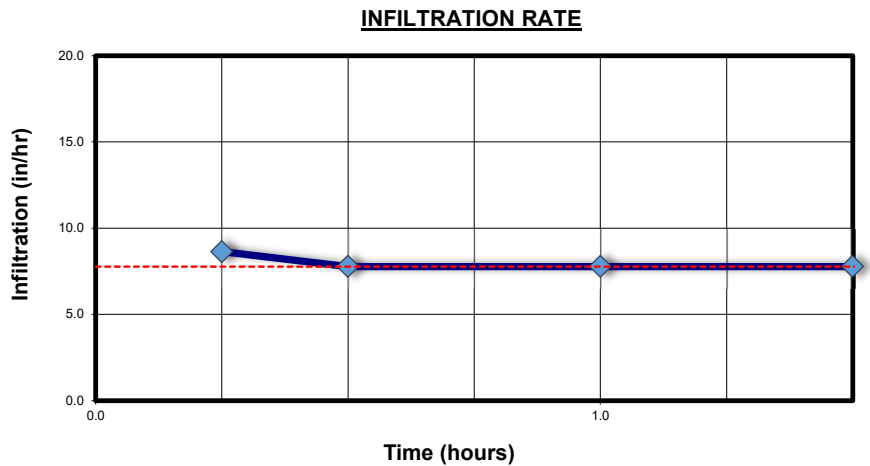
ARDAMAN & ASSOCIATES, INC.Geotechnical, Environmental and
Materials Consultants**DOUBLE-RING INFILTRATION TEST
RESULTS****(ASTM STANDARD D-3385)**

Project Name: LOCAR
 Project Location: Highlands County, Florida
 Project Number: 23-6363
 Outer Ring Diameter (in): 24
 Inner Ring Diameter (in): 12

Test Date: 5/23/2023
 Test Location: DRI-01
 Test Depth: 6" below existing ground surface
 Duration (hours): 1.5
 Test Head (inches): 4

INFILTRATION RATE: 7.8 inches per hour

Time Increment (minutes)	Infiltration per Time Period (inches)
15	2.16
15	1.94
30	3.88
30	3.88
--	--
--	--
--	--
--	--
--	--
--	--
--	--

**SUBSURFACE SOIL DATA**

Depth (ft)		BORING DATA
From	To	
<u>0.0</u>	<u>1.0</u>	<u>SAND (SP), light gray, fine</u>
<u>1.0</u>	<u>3.0</u>	<u>SAND (SP), dark brown, fine</u>
<u>3.0</u>	<u>5.0</u>	<u>SAND (SP), light brown, fine</u>

Groundwater measured at 4.3 feet below existing ground surface on 05-23-2023.**TEST PROCEDURES:**

The double-ring infiltration test was performed in general accordance with procedures outlined in the ASTM Standard D-3385. Two 18-inch high concentric rings were placed on a prepared test surface at a given depth and driven into the ground 4 to 6-inches. The inner ring used in the test had an inside diameter of approximately 12-inches, while the outer ring had an inside diameter of approximately 24-inches. The test was performed by filling both rings with water to a height of 12 inches. A head of 3 to 6-inches is then maintained in both rings, and the amount of water required to maintain the head in the inner ring was recorded.

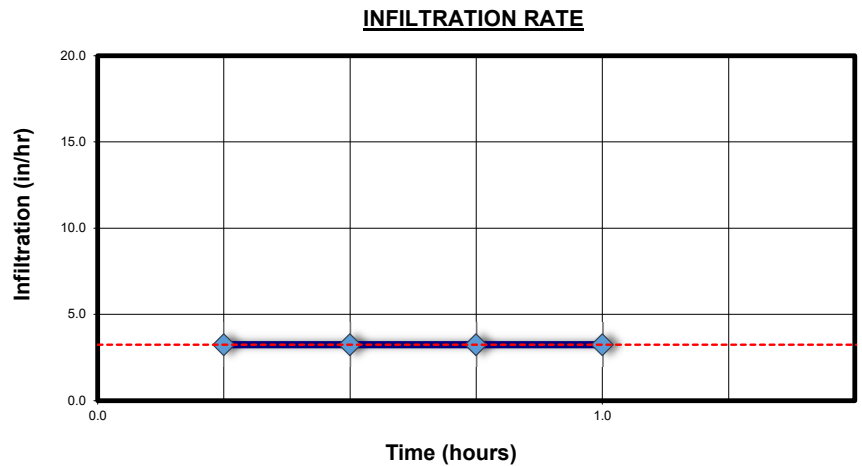
ARDAMAN & ASSOCIATES, INC.Geotechnical, Environmental and
Materials Consultants**DOUBLE-RING INFILTRATION TEST
RESULTS****(ASTM STANDARD D-3385)**

Project Name: LOCAR
 Project Location: Highlands County, Florida
 Project Number: 23-6363
 Outer Ring Diameter (in): 24
 Inner Ring Diameter (in): 12

Test Date: 5/24/2023
 Test Location: DRI-02
 Test Depth: 6" below existing ground surface
 Duration (hours): 1.5
 Test Head (inches): 4

INFILTRATION RATE: 3.2 inches per hour

Time Increment (minutes)	Infiltration per Time Period (inches)
15	0.81
15	0.81
15	0.81
15	0.81
--	--
--	--
--	--
--	--
--	--
--	--

**SUBSURFACE SOIL DATA**

Depth (ft)		BORING DATA
From	To	
<u>0.0</u>	<u>1.0</u>	<u>SAND (SP), gray, fine</u>
<u>1.0</u>	<u>3.0</u>	<u>SAND (SP), light gray, fine</u>
<u>3.0</u>	<u>5.0</u>	<u>SAND WITH CLAY (SP-SC), gray brown, fine</u>

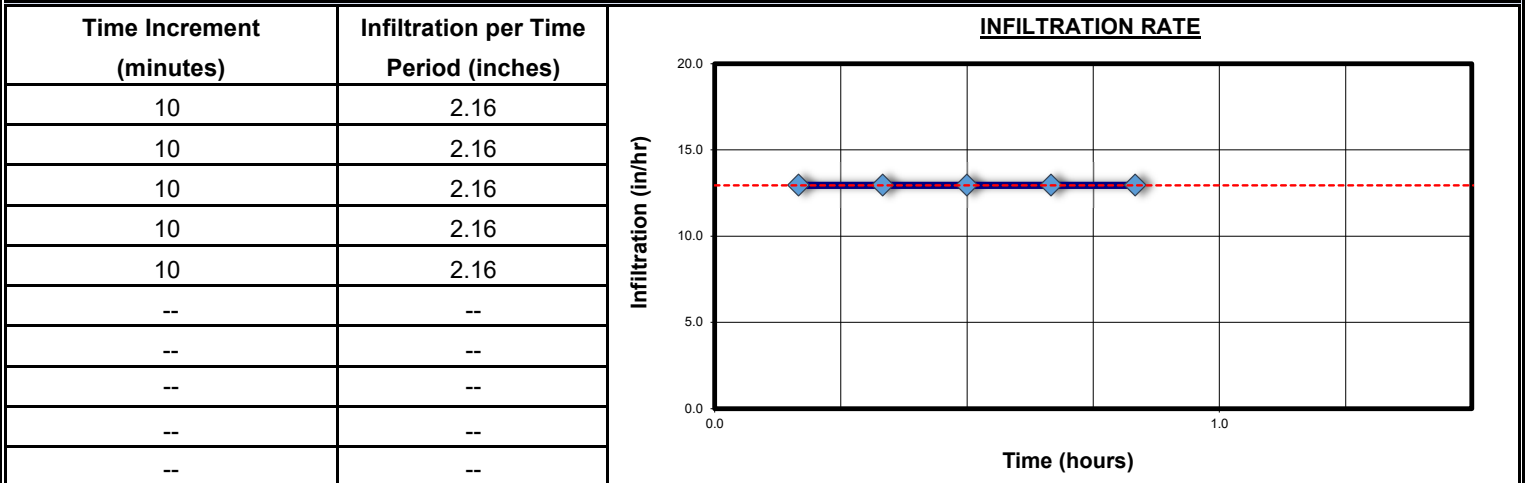
Groundwater measured at 4.5 feet below existing ground surface on 05-24-2023.**TEST PROCEDURES:**

The double-ring infiltration test was performed in general accordance with procedures outlined in the ASTM Standard D-3385. Two 18-inch high concentric rings were placed on a prepared test surface at a given depth and driven into the ground 4 to 6-inches. The inner ring used in the test had an inside diameter of approximately 12-inches, while the outer ring had an inside diameter of approximately 24-inches. The test was performed by filling both rings with water to a height of 12 inches. A head of 3 to 6-inches is then maintained in both rings, and the amount of water required to maintain the head in the inner ring was recorded.

ARDAMAN & ASSOCIATES, INC.Geotechnical, Environmental and
Materials Consultants**DOUBLE-RING INFILTRATION TEST
RESULTS****(ASTM STANDARD D-3385)**

Project Name: LOCAR
 Project Location: Highlands County, Florida
 Project Number: 23-6363
 Outer Ring Diameter (in): 24
 Inner Ring Diameter (in): 12

Test Date: 5/23/2023
 Test Location: DRI-03
 Test Depth: 6" below existing ground surface
 Duration (hours): 1.5
 Test Head (inches): 4

INFILTRATION RATE: 12.9 inches per hour**SUBSURFACE SOIL DATA**

Depth (ft)		BORING DATA
From	To	
<u>0.0</u>	<u>1.0</u>	<u>SAND (SP), gray, fine</u>
<u>1.0</u>	<u>3.0</u>	<u>SAND (SP), very light gray, fine</u>
<u>3.0</u>	<u>5.0</u>	<u>SAND WITH SILT (SP-SM), dark gray, fine</u>

Groundwater measured at 4.1 feet below existing ground surface on 05-23-2023.**TEST PROCEDURES:**

The double-ring infiltration test was performed in general accordance with procedures outlined in the ASTM Standard D-3385. Two 18-inch high concentric rings were placed on a prepared test surface at a given depth and driven into the ground 4 to 6-inches. The inner ring used in the test had an inside diameter of approximately 12-inches, while the outer ring had an inside diameter of approximately 24-inches. The test was performed by filling both rings with water to a height of 12 inches. A head of 3 to 6-inches is then maintained in both rings, and the amount of water required to maintain the head in the inner ring was recorded.

APPENDIX VI

Soil Sample Photo Log

Boring B-02, Shelby Tube Samples
Lake Okeechobee Component A Restoration (LOCAR)
Highlands County, Florida



Boring B-02, Sample 1, 48-50 feet



Boring B-02, Sample 2, 56-58 feet



Boring B-02, Sample 3, 61-63 feet

Boring B-05, Shelby Tube Samples
Lake Okeechobee Component A Restoration (LOCAR)
Highlands County, Florida



Boring B-05, Sample 25, 48-50 feet



Boring B-05, Sample 29, 58-60 feet

Boring B-06, Shelby Tube Samples
Lake Okeechobee Component A Restoration (LOCAR)
Highlands County, Florida



Boring B-06, Sample 16, 52-54 feet

Boring B-23, Shelby Tube Samples
Lake Okeechobee Component A Restoration (LOCAR)
Highlands County, Florida



Boring B-23, Sample 1, 60-62 feet

Boring PZ-06, Shelby Tube Samples
Lake Okeechobee Component A Restoration (LOCAR)
Highlands County, Florida



Boring PZ-06, Sample 12, 30-32 feet

Photo Log: B-01

<p>S-1 HA [No Photo] 0.0 - 1.5</p>	<p>S-2 HA [No Photo] 1.5 - 3.0</p>	<p>S-3 HA [No Photo] 3.0 - 4.5</p>
--	--	--

S-4 SPT 4.5 - 6.0



S-5 SPT 6.0 - 7.5



S-6 SPT 7.5 - 9.0

LOCAR
B-01
S-06
6.0-7.5



S-7 SPT 9.0 - 10.5



S-8 SPT 13.5 - 15.0



Photo Log: B-01, cont.

S-9 SPT 18.5 - 20.0



S-10 SPT 23.5 - 25.0



S-11 SPT 28.5 - 30.0



S-12 SPT 33.5 - 35.0

LOCAR
B-01
S-12
33.5-35



S-13 SPT 38.5 - 40.0



S-14 SPT 43.5 - 45.0



Photo Log: B-01, cont.

S-15 SPT 48.5 - 50.0

**LOCAR
B-01
S-15
48.5-50**



S-16 SPT 53.5 - 55.0



S-17 SPT 58.5 - 60.0



S-18 SPT 63.5 - 65.0



S-19 SPT 68.5 - 70.0

**LOCAR
B-01
S-19
68.5-70**



S-20 SPT 73.5 - 75.0

[No Recovery]

Photo Log: B-01, cont.

S-21 SPT 78.5 - 80.5



S-22 SPT 83.5 - 85.0



S-23 SPT 88.5 - 90.0

[No Photo]

S-24 SPT 93.5 - 95.0



S-25 SPT 98.5 - 100.0



S-26 SPT 103.5 - 105.0



Photo Log: B-01, cont.

S-27 SPT 108.5 - 110.0



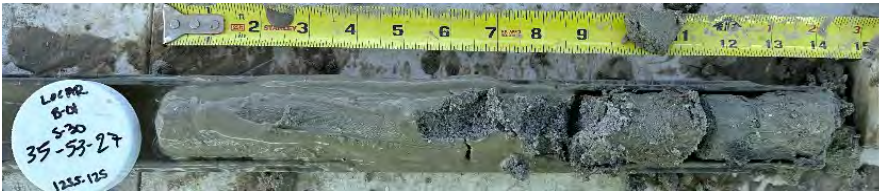
S-28 SPT 113.5 - 115.0



S-29 SPT 118.5 - 120.0



S-30 SPT 123.5 - 125.0



S-31 SPT 128.5 - 130.0



S-32 SPT 133.5 - 135.0



Photo Log: B-01, cont.

S-33 SPT 138.5 - 140.0



S-34 SPT 143.5 - 145.0



S-35 SPT 148.5 - 150.0



Photo Log: B-02

S-1
HA
0.0
-
1.5



S-2
HA
1.5
-
3.0



S-3
HA
3.0
-
4.5



S-4 SPT 4.5 - 6.0



S-5 SPT 6.0 - 7.5



S-6 SPT 7.5 - 9.0



S-7 SPT 9.0 - 10.5



S-8 SPT 11.0 - 12.5



Photo Log: B-02, cont.

S-9 SPT 13.5 - 15.0



S-10 SPT 16.0 - 17.5



S-11 SPT 18.5 - 20.0



S-12 SPT 21.0 - 22.5



S-13 SPT 23.5 - 25.0



S-14 SPT 26.0 - 27.5

[Photo not taken]

Photo Log: B-02, cont.

S-15 SPT 28.5 - 30.0



S-16 SPT 31.0 - 32.5



S-17 SPT 33.5 - 35.0



S-18 SPT 36.0 - 37.5



S-19 SPT 38.5 - 40.0



S-20 SPT 41.0 - 42.5



Photo Log: B-02, cont.

S-21 SPT 43.5 - 45.0



S-22 SPT 46.0 - 47.5



S-23 SPT 48.5 - 50.0



S-24 SPT 51.0 - 52.5



S-25 SPT 53.5 - 55.0



S-26 SPT 56.0 - 57.5



Photo Log: B-02, cont.

S-27 SPT 58.5 - 60.0

No Recovery

S-28 SPT 61.0 - 62.5

No Recovery

S-29 SPT 63.5 - 65.0

No Recovery

S-30 SPT 66.0 - 68*



S-31 SPT 68.5 - 70.0



S-32 SPT 71.0 - 72.5

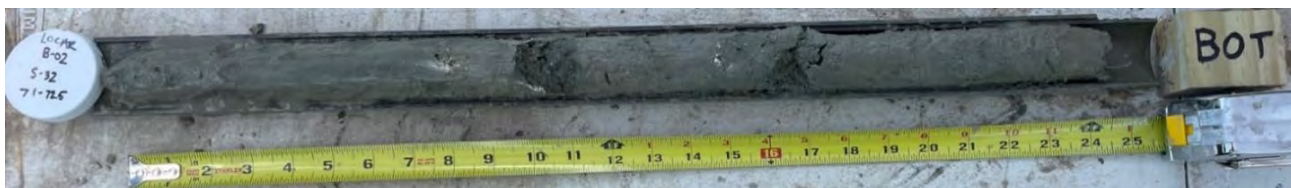


Photo Log: B-02, cont.

S-33 SPT 73.5 - 75.0



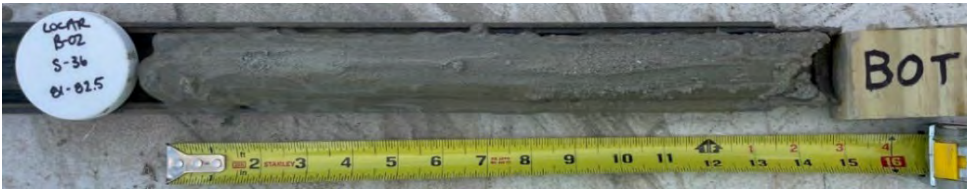
S-34 SPT 76.0 - 77.5



S-35 SPT 78.5 - 80.0



S-36 SPT 81.0 - 82.5



S-37 SPT 83.5 - 85.0

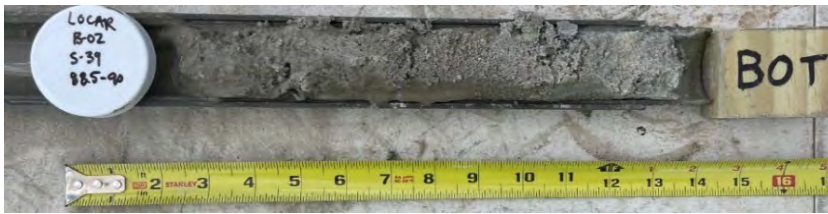


S-38 SPT 86.0 - 87.5



Photo Log: B-02, cont.

S-39 SPT 88.5 - 90.0



S-40 SPT 91.0 - 92.5



S-41 SPT 93.5 - 95.0



S-42 SPT 96.0 - 97.5

[Photo not taken]

S-43 SPT 98.5 - 100.0



Photo Log: B-02, cont.



Photo Log: B-03

S-1
HA
0.0
-
1.5



S-2
HA
1.5
-
3.0



S-3
HA
3.0
-
4.5



S-4 SPT 4.5 - 6.0



S-5 SPT 6.0 - 7.5



S-6 SPT 7.5 - 9.0



S-7 SPT 9.0 - 10.5



S-8 SPT 13.5 - 15.0



S-9 SPT 18.5 - 20.0



Photo Log: B-03, cont.

S-10 SPT 23.5 - 25.0



S-11 SPT 28.5 - 30.0



S-12 SPT 33.5 - 35.0



S-13 SPT 38.5 - 40.0



S-14 SPT 43.5 - 45.0



S-15 SPT 48.5 - 50.0



S-16 SPT 53.5 - 55.0



Photo Log: B-03, cont.

S-17 SPT 58.5 - 60.0



S-18 SPT 63.5 - 65.0



S-19 SPT 68.5 - 70.0



S-20 SPT 73.5 - 75.0



Photo Log: B-03, cont.

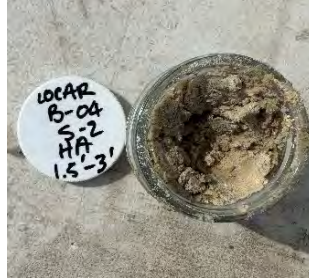


Photo Log: B-04

S-1
HA
0.0
-
1.5



S-2
HA
1.5
-
3.0



S-3
HA
3.0
-
4.5



S-4 SPT 4.5 - 6.0



S-5 SPT 6.0 - 7.5



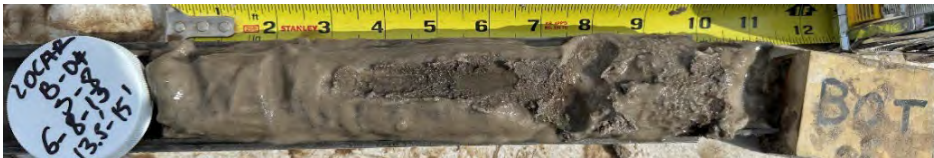
S-6 SPT 7.5 - 9.0



S-7 SPT 9.0 - 10.5



S-8 SPT 13.5 - 15.0



S-9 SPT 18.5 - 20.0



Photo Log: B-04, cont.

S-10 SPT 23.5 - 25.0



S-11 SPT 28.5 - 30.0



S-12 SPT 33.5 - 35.0



S-13 SPT 38.5 - 40.0



S-14 SPT 43.5 - 45.0



S-15 SPT 48.5 - 50.0



S-16 SPT 53.5 - 55.0



Photo Log: B-04, cont.

S-17 SPT 58.5 - 60.0



S-18 SPT 63.5 - 65.0



S-19 SPT 68.5 - 70.0



S-20 SPT 73.5 - 75.0



Photo Log: B-04, cont.



Photo Log: B-05

S-1
HA
0.0
-
1.5



S-2
HA
1.5
-
3.0



S-3
HA
3.0
-
4.5



S-4 SPT 4.5 - 6.0



S-5 SPT 6.0 - 7.5



S-6 SPT 7.5 - 9.0



S-7 SPT 9.0 - 10.5



S-8 SPT 10.5 - 12.0



Photo Log: B-05, cont.

S-9 SPT 12.0 - 13.5



S-10 SPT 13.5 - 15.0



S-11 SPT 15.0 - 16.5



S-12 SPT 16.5 - 18.0



S-13 SPT 18.0 - 20.0



S-14 SPT 21.0 - 22.5



Photo Log: B-05, cont.

S-15 SPT 23.5 - 25.0



S-16 SPT 26.0 - 27.5



S-17 SPT 28.5 - 30.0



S-18 SPT 31.0 - 32.5



S-19 SPT 33.5 - 35.0



S-20 SPT 36.0 - 37.5



Photo Log: B-05, cont.

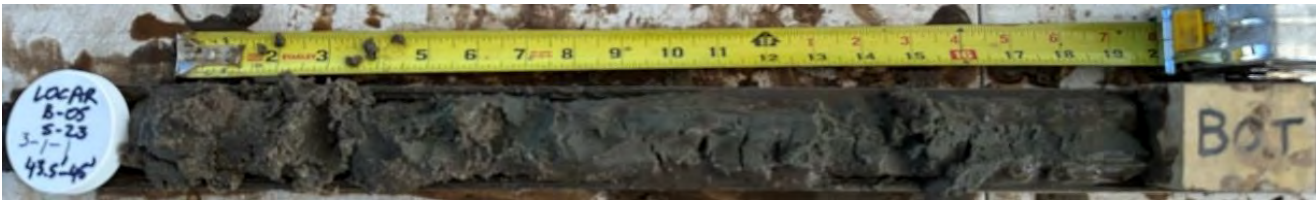
S-21 SPT 38.5 - 40.0



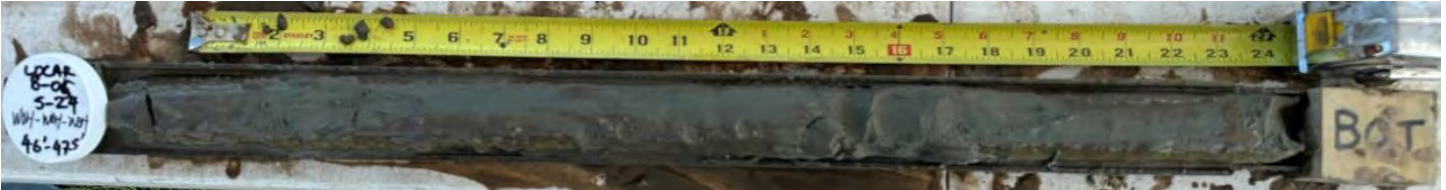
S-22 SPT 41.0 - 42.5



S-23 SPT 43.5 - 45.0



S-24 SPT 46.0 - 47.5



S-25 Shelby Tube 48.5 - 50.0



S-26 SPT 51.0 - 52.5



Photo Log: B-05, cont.

S-27 SPT 53.5 - 55.0



S-28 SPT 56.0 - 57.5



S-29 Shelby Tube 58.5 - 60.0



S-30 SPT 61.0 - 62.5



S-31 SPT 63.5 - 65.0



S-32 SPT 66.0 - 67.5



Photo Log: B-05, cont.

S-33 SPT 68.5 - 70.0



S-34 SPT 71.0 - 72.5



S-35 SPT 73.5 - 75.0



S-36 SPT 78.5 - 80.0



S-37 SPT 83.5 - 85.0



S-38 SPT 88.5 - 90.0

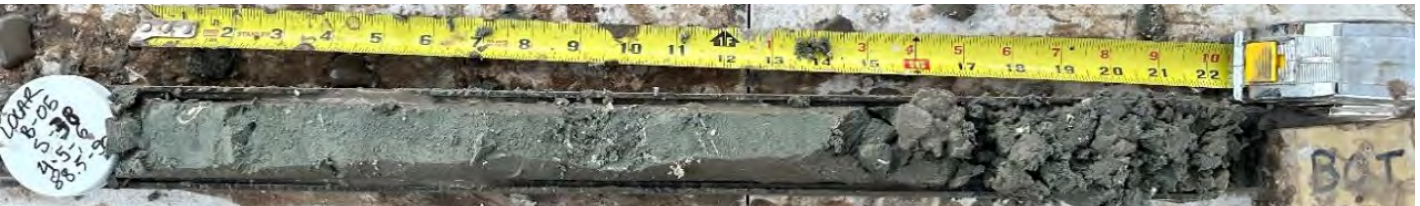


Photo Log: B-05, cont.

S-39 SPT 93.5 - 95.0

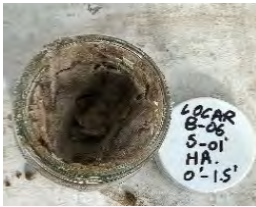


S-40 SPT 98.5 - 100.0



Photo Log: B-06

S-1
HA
0.0
-
1.5



S-2
HA
1.5
-
3.0



S-3
HA
3.0
-
4.5



S-4 SPT 4.5 - 6.0



S-5 SPT 6.0 - 7.5



S-6 SPT 7.5 - 9.0



S-7 SPT 9.0 - 10.5



S-8 SPT 13.5 - 15.0



Photo Log: B-06, cont.

S-9 SPT 18.5 - 20.0



S-10 SPT 23.5 - 25.0



S-11 SPT 28.5 - 30.0



S-12 SPT 33.5 - 35.0



S-13 SPT 38.5 - 40.0



S-14 SPT 43.5 - 45.0

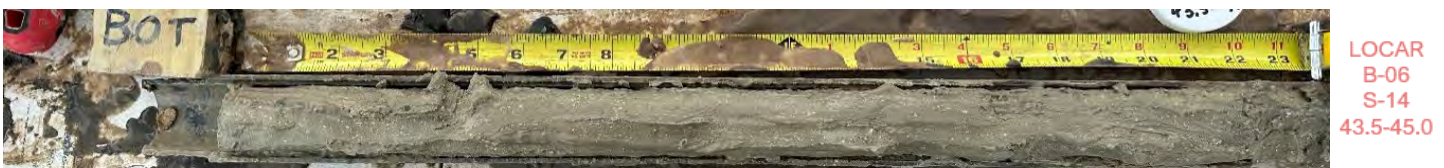


Photo Log: B-06, cont.

S-15 SPT 48.5 - 50.0



S-16 Shelby Tube 53.5 - 55.0



S-17 SPT 58.5 - 60.0



S-18 SPT 63.5 - 65.0



S-19 SPT 68.5 - 70.0



S-20 SPT 73.5 - 75.0



Photo Log: B-06, cont.

S-19 SPT 78.5 - 80.0

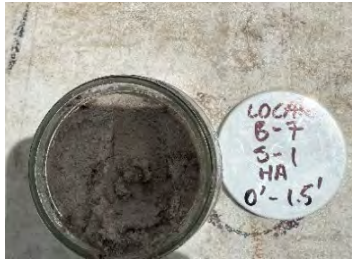


S-20 SPT 83.5 - 95.0



Photo Log: B-07

S-1
HA
0.0
-
1.5



S-2
HA
1.5
-
3.0



S-3
HA
3.0
-
4.5



S-4 SPT 4.5 - 6.0



S-5 SPT 6.0 - 7.5



S-6 SPT 7.5 - 9.0



S-7 SPT 9.0 - 10.5



S-8 SPT 13.5 - 15.0



S-9 SPT 18.5 - 20.0



Photo Log: B-07, cont.

S-10 SPT 23.5 - 25.0



S-11 SPT 28.5 - 30.0



S-12 SPT 33.5 - 35.0



S-13 SPT 38.5 - 40.0



S-14 SPT 43.5 - 45.0



S-15 SPT 48.5 - 50.0



S-16 SPT 53.5 - 55.0



Photo Log: B-07, cont.

S-17 SPT 58.5 - 60.0



S-18 SPT 63.5 - 65.0



S-19 SPT 68.5 - 70.0



S-20 SPT 73.5 - 75.0



Photo Log: B-07, cont.



Photo Log: B-08

S-1
HA
 0.0
 -
 1.5



S-2
HA
 1.5
 - [Photo Not Taken]
 3.0

S-3
HA
 3.0
 -
 4.5



S-4 **SPT** 4.5 - 6.0



S-5 **SPT** 6.0 - 7.5



S-6 **SPT** 7.5 - 9.0



S-7 **SPT** 9.0 - 10.5



S-8 **SPT** 13.5 - 15.0



S-9 **SPT** 18.5 - 20.0



Photo Log: B-08, cont.

S-10 SPT 23.5 - 25.0



S-11 SPT 28.5 - 30.0



S-12 SPT 33.5 - 35.0



S-13 SPT 38.5 - 40.0



S-14 SPT 43.5 - 45.0



S-15 SPT 48.5 - 50.0

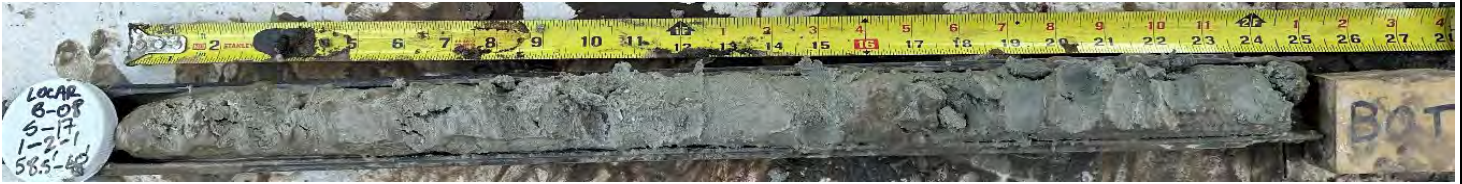


Photo Log: B-08, cont.

S-16 SPT 53.5 - 55.0



S-17 SPT 58.5 - 60.0



S-18A SPT 63.5 - 64.0



S-18B SPT 64.0 - 65.0



S-19 SPT 68.5 - 70.0



S-20 SPT 73.5 - 75.0



S-21 SPT 78.5 - 80.0



Photo Log: B-08, cont.

S-22 SPT 83.5 - 85.0



S-23 SPT 88.5 - 90.0



S-24 SPT 93.5 - 95.0



S-25 SPT 98.5 - 100.0



Photo Log: B-08, cont.



Photo Log: B-09

S-1
HA
0.0
-
1.5



S-2
HA
1.5
-
3.0



S-3
HA
3.0
-
4.5

[Photo Not Taken]

S-4 SPT 4.5 - 6.0



S-5 SPT 6.0 - 7.5



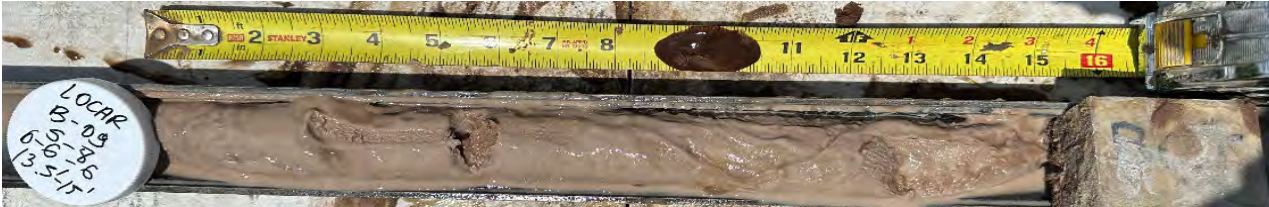
S-6 SPT 7.5 - 9.0



S-7 SPT 9.0 - 10.5



S-8 SPT 13.5 - 15.0



S-9 SPT 18.5 - 20.0

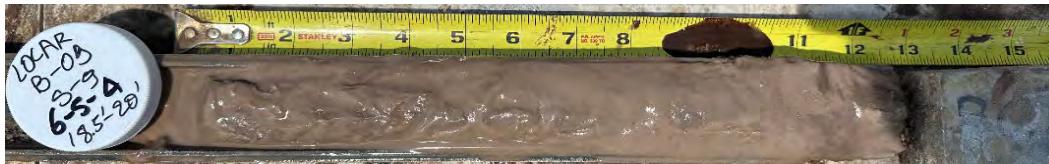
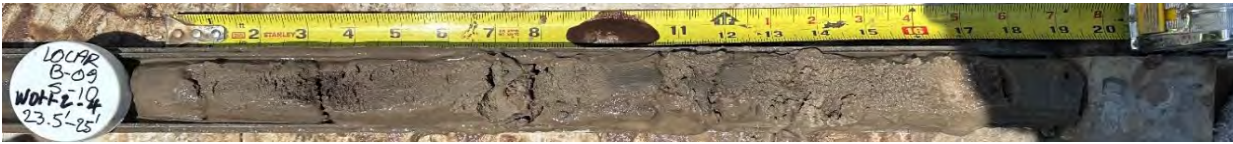


Photo Log: B-09, cont.

S-10 SPT 23.5 - 25.0



S-11 SPT 28.5 - 30.0



S-12 SPT 33.5 - 35.0



S-13 SPT 38.5 - 40.0



S-14 SPT 43.5 - 45.0



S-15 SPT 48.5 - 50.0

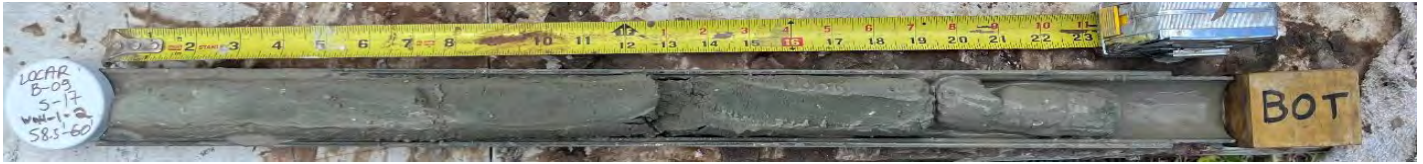


S-16 SPT 53.5 - 55.0



Photo Log: B-09, cont.

S-17 SPT 58.5 - 60.0



S-18 SPT 63.5 - 64.0



S-19 SPT 68.5 - 70.0



S-20 SPT 73.5 - 75.0

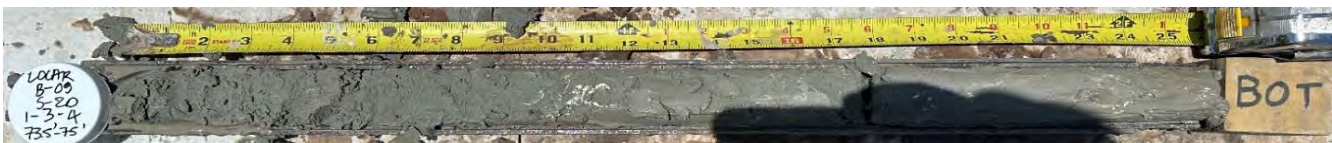


Photo Log: B-09, cont.

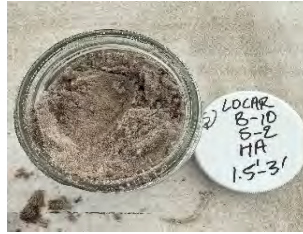


Photo Log: B-10

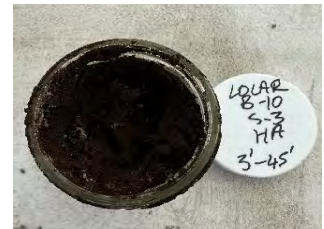
S-1
HA
0.0
-
1.5



S-2
HA
1.5
-
3.0



S-3
HA
3.0
-
4.5



S-4 **SPT** 4.5 - 6.0



S-5 **SPT** 6.0 - 7.5



S-6 **SPT** 7.5 - 9.0



S-7 **SPT** 9.0 - 10.5



S-8 **SPT** 10.5 - 12.0



S-9 **SPT** 12.0 - 13.5

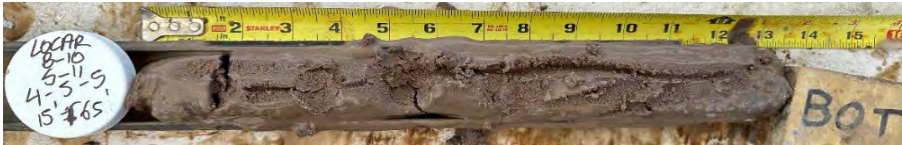


Photo Log: B-10, cont.

S-10 SPT 13.5 - 15.0



S-11 SPT 15.0 - 16.5



S-12 SPT 16.5 - 18.0



S-13 SPT 18.0 - 20.0



S-14 SPT 23.5 - 25.0



S-15 SPT 28.5 - 30.0



S-16 SPT 33.5 - 35.0



Photo Log: B-10, cont.

S-17 SPT 38.5 - 40.0



S-18 SPT 43.5 - 45.0



S-19 SPT 48.5 - 50.0



S-20 SPT 53.5 - 55.0



S-21 SPT 58.5 - 60.0



S-22 SPT 63.5 - 65.0



Photo Log: B-10, cont.

S-23 SPT 68.5 - 70.0



S-24 SPT 73.5 - 75.0



S-25 SPT 78.5 - 80.0



S-26 SPT 83.5 - 85.0



S-27 SPT 88.5 - 90.0

[No Recovery]

S-28 SPT 93.5 - 95.0



S-29 SPT 98.5 - 100.0



Photo Log: B-10, cont.

S-30 SPT 103.5 - 105.0



S-31 SPT 108.5 - 110.0



S-32 SPT 113.5 - 115.0



S-33 SPT 118.5 - 120.0



S-34 SPT 123.5 - 125.0



S-35 SPT 128.5 - 130.0

[No Photo Taken]

S-36 SPT 133.5 - 135.0



Photo Log: B-10, cont.

S-37 SPT 138.5 - 140.0



S-38 SPT 143.5 - 145.0



S-39 SPT 148.5 - 150.0



Photo Log: B-11

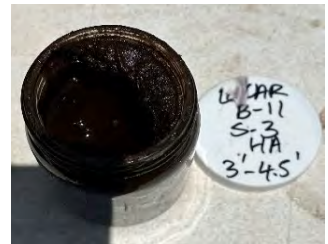
S-1
HA
0.0
-
1.5



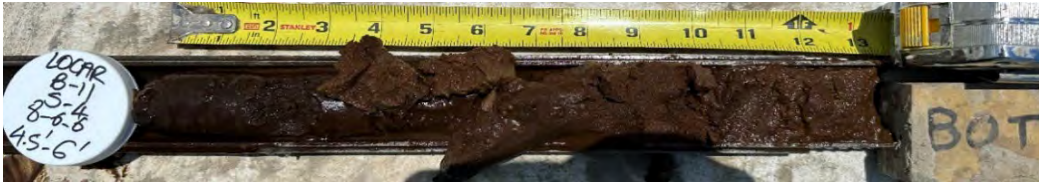
S-2
HA
1.5
-
3.0



S-3
HA
3.0
-
4.5



S-4 **SPT** 4.5 - 6.0



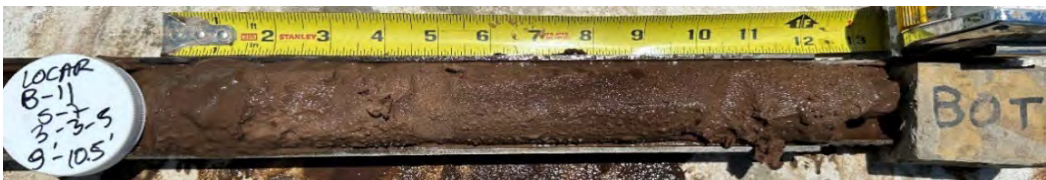
S-5 **SPT** 6.0 - 7.5



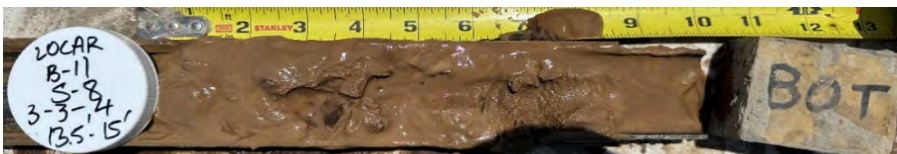
S-6 **SPT** 7.5 - 9.0



S-7 **SPT** 9.0 - 10.5



S-8 **SPT** 13.5 - 15.0



S-9 **SPT** 18.5 - 20.0



Photo Log: B-11, cont.

S-10 SPT 23.5 - 25.0



S-11 SPT 28.5 - 30.0



S-12 SPT 33.5 - 35.0



S-13 SPT 38.5 - 40.0



S-14 SPT 43.5 - 45.0



S-15 SPT 48.5 - 50.0



S-16 SPT 53.5 - 55.0



Photo Log: B-11, cont.

S-17 SPT 58.5 - 60.0



S-18 SPT 63.5 - 65.0



S-19 SPT 68.5 - 70.0



S-20 SPT 73.5 - 75.0



Photo Log: B-11, cont.



Photo Log: B-12

S-1
HA
0.0
-
1.5



S-2
HA
1.5
-
3.0



S-3
HA
3.0
-
4.5



S-4 SPT 4.5 - 6.0



S-5 SPT 6.0 - 7.5



S-6 SPT 7.5 - 9.0



S-7 SPT 9.0 - 10.5



S-8 SPT 13.5 - 15.0



S-9 SPT 18.5 - 20.0



Photo Log: B-12, cont.

S-10 SPT 23.5 - 25.0



S-11 SPT 28.5 - 30.0



S-11A SPT 33.5 - 35.0



S-11B SPT 38.5 - 40.0



S-12 SPT 33.5 - 35.0



S-13 SPT 38.5 - 40.0



S-14 SPT 43.5 - 45.0

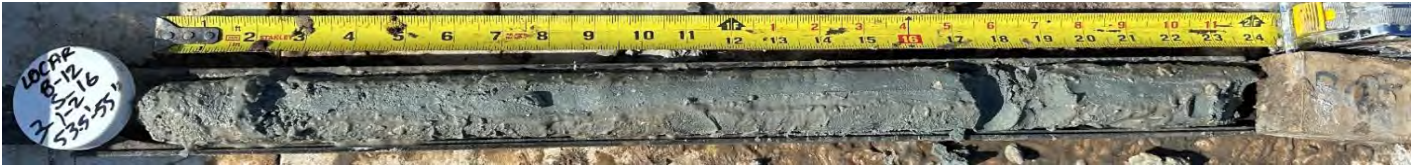


Photo Log: B-12, cont.

S-15 SPT 48.5 - 50.0



S-16 SPT 53.5 - 55.0



S-17 SPT 58.5 - 60.0



S-18 SPT 63.5 - 65.0



S-19 SPT 68.5 - 70.0



S-20 SPT 73.5 - 75.0



Photo Log: B-12, cont.



Photo Log: B-13

S-1 SPT 0.0 - 1.5



S-2 SPT 1.5 - 3.0



S-3 SPT 3.0 - 4.5



S-4 SPT 4.5 - 6.0



S-5 SPT 6.0 - 7.5



S-6 SPT 7.5 - 9.0



S-7 SPT 9.0 - 10.5



Photo Log: B-13, cont.

S-8 SPT 13.5 - 15.0



S-9 SPT 18.5 - 20.0



S-10 SPT 23.5 - 25.0



S-11 SPT 28.5 - 30.0



S-12 SPT 33.5 - 35.0



S-13 SPT 38.5 - 40.0



Photo Log: B-14

S-1 SPT 0.0 - 1.5



S-2 SPT 1.5 - 3.0



S-3 SPT 3.0 - 4.5



S-4 SPT 4.5 - 6.0



S-5 SPT 6.0 - 7.5



S-6 SPT 7.5 - 9.0



Photo Log: B-14, cont.

S-7 SPT 9.0 - 10.5
[No photo taken]

S-8 SPT 13.5 - 15.0



S-9 SPT 18.5 - 20.0
[No Recovery]

S-10 SPT 23.5 - 25.0



S-11 SPT 28.5 - 30.0



S-12 SPT 33.5 - 35.0



S-13 SPT 38.5 - 40.0

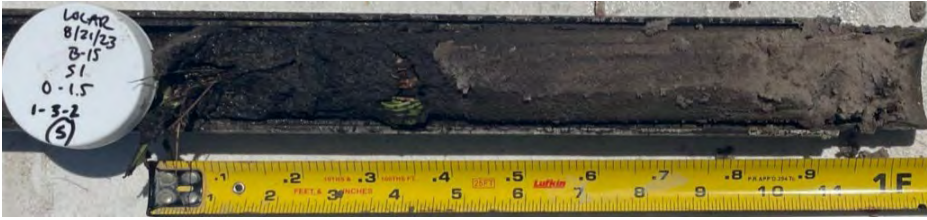


S-14 SPT 43.5 - 45.0

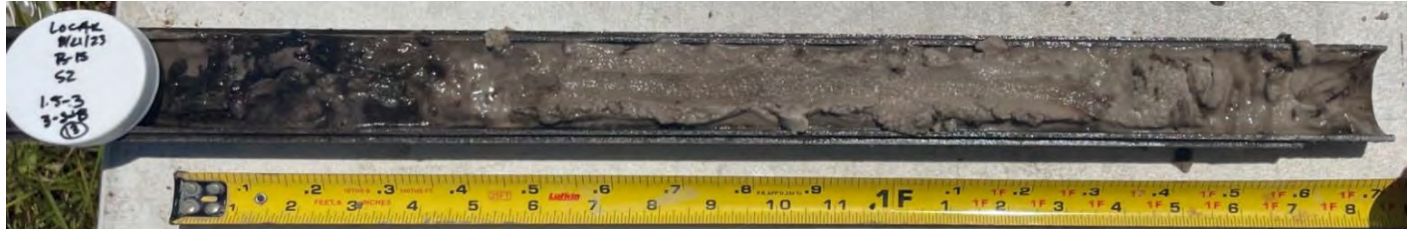


Photo Log: B-15

S-1 SPT 0.0 - 1.5



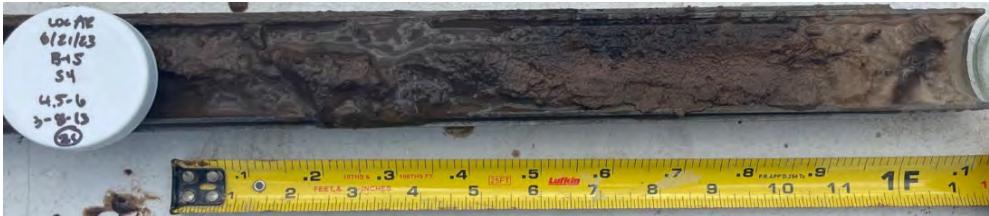
S-2 SPT 1.5 - 3.0



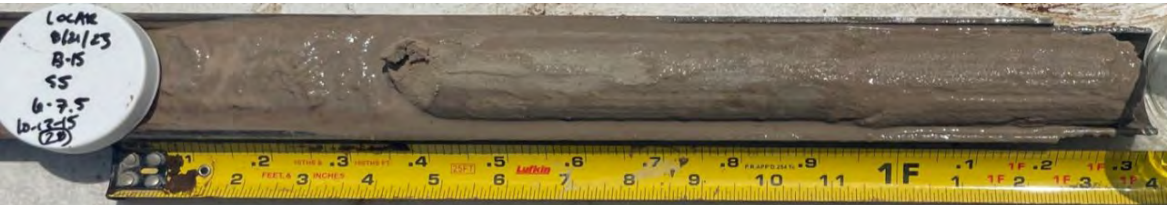
S-3 SPT 3.0 - 4.5

[No photo taken]

S-4 SPT 4.5 - 6.0



S-5 SPT 6.0 - 7.5



S-6 SPT 7.5 - 9.0



Photo Log: B-15, cont.

S-7 SPT 9.0 - 10.5



S-8 SPT 13.5 - 15.0



S-9 SPT 18.5 - 20.0



S-10 SPT 23.5 - 25.0



S-11 SPT 28.5 - 30.0



S-12 SPT 33.5 - 35.0

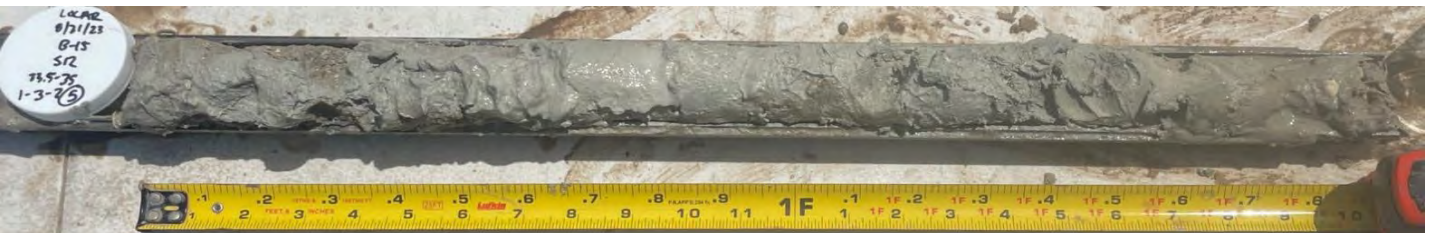


Photo Log: B-15, cont.

S-13 SPT 38.5 - 40.0



S-14 SPT 43.5 - 45.0



Photo Log: B-16

S-1 SPT 0.0 - 1.5



S-2 SPT 1.5 - 3.0



S-3 SPT 3.0 - 4.5



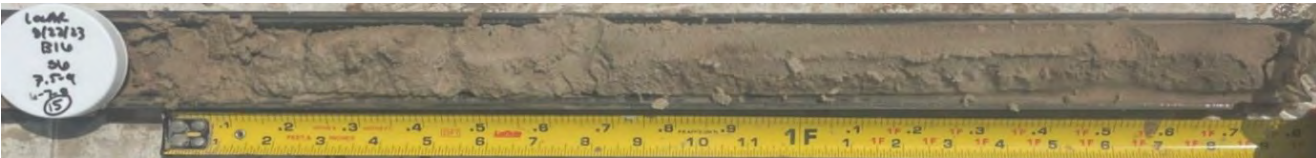
S-4 SPT 4.5 - 6.0



S-5 SPT 6.0 - 7.5



S-6 SPT 7.5 - 9.0



S-7 SPT 9.0 - 10.5



Photo Log: B-16, cont.

S-8 SPT 13.5 - 15.0



S-9 SPT 18.5 - 20.0



S-10 SPT 23.5 - 25.0



S-11 SPT 28.5 - 30.0



S-12 SPT 33.5 - 35.0



S-13 SPT 38.5 - 40.0



S-14 SPT 43.5 - 45.0



Photo Log: B-17

S-1
HA
0.0
-
1.5



S-2 SPT 1.5 - 3.0



S-3 SPT 3.0 - 4.5



S-4 SPT 4.5 - 6.0



S-5 SPT 6.0 - 7.5



S-6 SPT 7.5 - 9.0



S-7 SPT 9.0 - 10.5



Photo Log: B-17, cont.

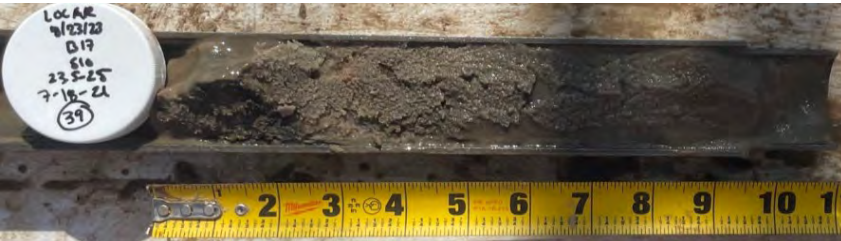
S-8 SPT 13.5 - 15.0



S-9 SPT 18.5 - 20.0



S-10 SPT 23.5 - 25.0



S-11 SPT 28.5 - 30.0



S-12 SPT 33.5 - 35.0



S-13 SPT 38.5 - 40.0



Photo Log: B-18

S-1
HA
0.0
-
1.5



S-2 SPT 1.5 - 3.0



S-3 SPT 3.0 - 4.5



S-4 SPT 4.5 - 6.0



S-5 SPT 6.0 - 7.5



S-6 SPT 7.5 - 9.0



Photo Log: B-18, cont.

S-7 SPT 9.0 - 10.5



S-8 SPT 13.5 - 15.0



S-9 SPT 18.5 - 20.0



S-10 SPT 23.5 - 25.0



S-11 SPT 28.5 - 30.0



S-12 SPT 33.5 - 35.0



Photo Log: B-18, cont.

S-13 SPT 38.5 - 40.0



S-14 SPT 43.5 - 45.0



S-15 SPT 48.5 - 50.0



S-16 SPT 53.5 - 55.0



S-17 SPT 58.5 - 60.0



S-18 SPT 63.5 - 65.0



Photo Log: B-18, cont.

S-19 SPT 68.5 - 70.0



S-20 SPT 73.5 - 75.0



S-21 SPT 78.5 - 80.0



Photo Log: B-19

S-1
HA
 0.0
 -
 1.5



S-2
HA
 1.5
 -
 3.0



S-3
HA
 3.0
 -
 4.5



S-4 **SPT** 4.5 - 6.0



S-5 **SPT** 6.0 - 7.5



S-6 **SPT** 7.5 - 9.0



S-7 **SPT** 9.0 - 10.5

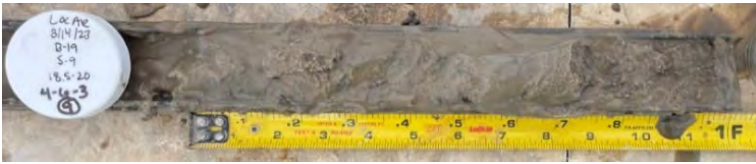


S-8 **SPT** 13.5 - 15.0



Photo Log: B-19, cont.

S-9 SPT 18.5 - 20.0



S-10 SPT 23.5 - 25.0



S-11 SPT 28.5 - 30.0



S-12 SPT 33.5 - 35.0



S-13 SPT 38.5 - 40.0



S-14 SPT 43.5 - 45.0

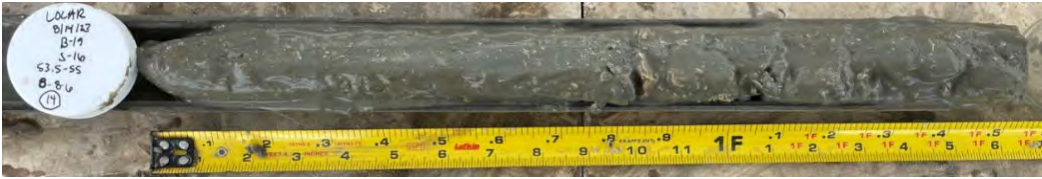


S-15 SPT 48.5 - 50.0



Photo Log: B-19, cont.

S-16 SPT 53.5 - 55.0



S-17 SPT 58.5 - 60.0



S-18 SPT 63.5 - 65.0



S-19 SPT 68.5 - 70.0



S-20 SPT 73.5 - 75.0



S-21 SPT 78.5 - 80.0



Photo Log: B-19, cont.




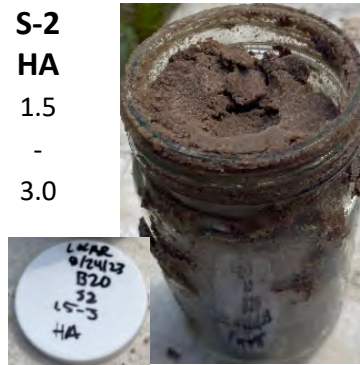
	SFWMD Lake Okeechobee Component A Reservoir (LOCAR)	Geotechnical Exploration	Figure: B-19 d Finish Date: 8/14/2023
--	---	--------------------------	--

Photo Log: B-20

S-1
HA
0.0
-
1.5



S-2
HA
1.5
-
3.0



S-3
HA
3.0
-
4.5



S-4 SPT 4.5 - 6.0



S-5 SPT 6.0 - 7.5



S-6 SPT 7.5 - 9.0



S-7 SPT 9.0 - 10.5



S-8 SPT 13.5 - 15.0



Photo Log: B-20, cont.

S-9 SPT 18.5 - 20.0



S-10 SPT 23.5 - 25.0



S-11 SPT 28.5 - 30.0



S-12 SPT 33.5 - 35.0



S-13 SPT 38.5 - 40.0

[No photo taken]

S-14 SPT 43.5 - 45.0



S-15 SPT 48.5 - 50.0



Photo Log: B-20, cont.

S-16 SPT 53.5 - 55.0



S-17 SPT 58.5 - 60.0



S-18 SPT 63.5 - 65.0



S-19 SPT 68.5 - 70.0



S-20 SPT 73.5 - 75.0



S-21 SPT 78.5 - 80.0



Photo Log: B-21

S-1
HA
0.0
-
1.5



S-2
HA
1.5
-
3.0



S-3
HA
3.0
-
4.5



S-4 SPT 4.5 - 6.0



S-5 SPT 6.0 - 7.5



S-6 SPT 7.5 - 9.0



S-7 SPT 9.0 - 10.5



S-8 SPT 13.5 - 15.0



S-9 SPT 18.5 - 20.0

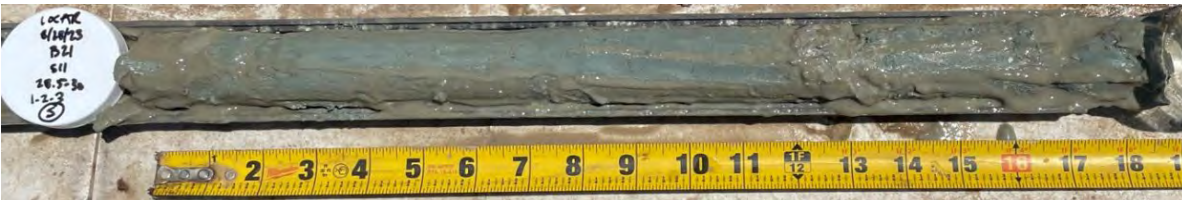


Photo Log: B-21, cont.

S-10 SPT 23.5 - 25.0



S-11 SPT 28.5 - 30.0



S-12 SPT 33.5 - 35.0



S-13 SPT 38.5 - 40.0

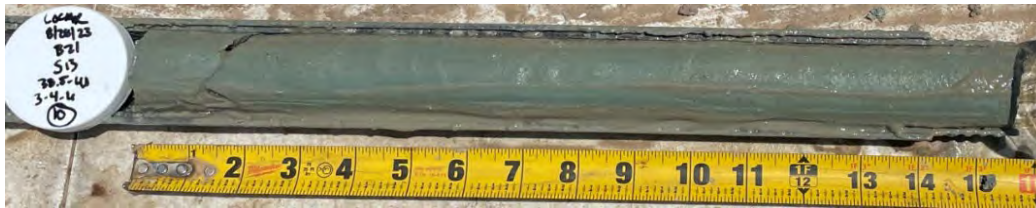


Photo Log: B-21, cont.



SFWMD
Lake Okeechobee Component A Reservoir
(LOCAR)

Geotechnical Exploration

Figure: B-21 c
Finish Date: 8/28/2023

Photo Log: B-22

S-1

HA

0.0 [No photo taken]

-

1.5

S-2

HA

1.5 [No phot taken]

-

3.0

S-3 SPT 3.0 - 4.5



S-4 SPT 4.5 - 6.0



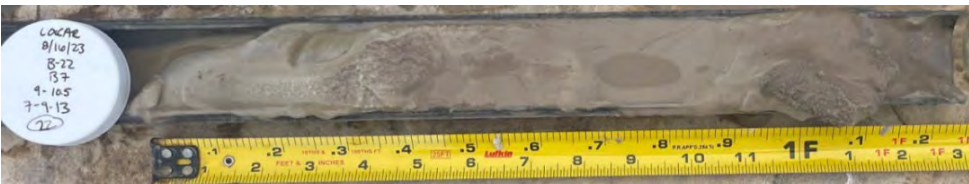
S-5 SPT 6.0 - 7.5



S-6 SPT 7.5 - 9.0



S-7 SPT 9.0 - 10.5



S-8 SPT 13.5 - 15.0

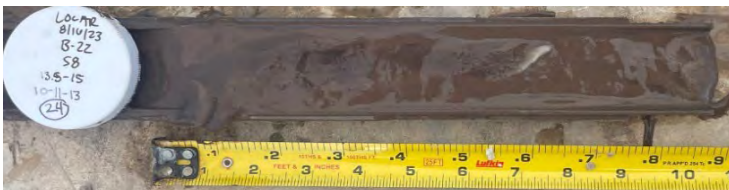


Photo Log: B-22, cont.

S-9 SPT 18.5 - 20.0



S-10 SPT 23.5 - 25.0



S-11 SPT 28.5 - 30.0



S-12 SPT 33.5 - 35.0



S-13 SPT 38.5 - 40.0



Photo Log: B-22, cont.



Photo Log: B-23

S-1 HA 0.0 - 1.5
[No Photo Taken]

S-2 SPT 1.5 - 3.0



S-3 SPT 3.0 - 4.5
[No picture taken]

S-4 SPT 4.5 - 6.0



S-5 SPT 6.0 - 7.5



S-6 SPT 7.5 - 9.0



S-7 SPT 9.0 - 10.5



Photo Log: B-23, cont.

S-8 SPT 13.5 - 15.0



S-9 SPT 18.5 - 20.0



S-10 SPT 23.5 - 25.0

[No Photo Taken]

S-11 SPT 28.5 - 30.0



S-12 SPT 33.5 - 35.0



S-13 SPT 38.5 - 40.0



Photo Log: B-23, cont.

S-14 SPT 43.5 - 45.0



S-15 SPT 48.5 - 50.0



S-16 SPT 53.5 - 55.0



S-17 SPT 58.5 - 60.0



S-18 SPT 63.5 - 65.0

[No Photo Taken]

S-19 SPT 68.5 - 70.0



Photo Log: B-24

S-1 HA 0.0 - 1.5
[No Photo Taken]

S-2 SPT 1.5 - 3.0



S-3 SPT 3.0 - 4.5



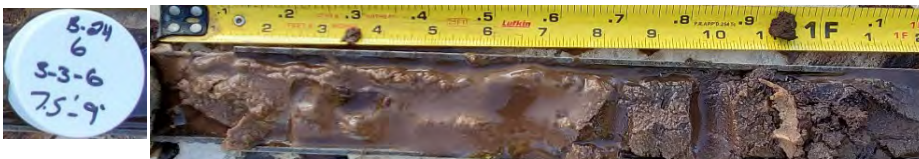
S-4 SPT 4.5 - 6.0



S-5 SPT 6.0 - 7.5



S-6 SPT 7.5 - 9.0



S-7 SPT 9.0 - 10.5



Photo Log: B-24, cont.

S-8 SPT 13.5 - 15.0



S-9 SPT 18.5 - 20.0



S-10 SPT 23.5 - 25.0



S-11 SPT 28.5 - 30.0



S-12 SPT 33.5 - 35.0



S-13 SPT 35.0 - 40.0



Photo Log: B-25

S-1
HA
0.0
-
1.5



S-2 SPT 1.5 - 3.0



S-3 SPT 3.0 - 4.5



S-4 SPT 4.5 - 6.0



S-5 SPT 6.0 - 7.5



S-6 SPT 7.5 - 9.0



Photo Log: B-25, cont.

S-7 SPT 9.0 - 10.5



S-8 SPT 13.5 - 15.0



S-9 SPT 18.5 - 20.0



S-10 SPT 23.5 - 25.0



S-11 SPT 28.5 - 30.0



S-12 SPT 33.5 - 35.0



Photo Log: B-25, cont.

S-13 SPT 38.5 - 40.0



S-14 SPT 43.5 - 45.0



Photo Log: PZ-01

S-1

HA [No Photo]

0.0

-

1.5

S-2

HA [No Photo]

1.5

-

3.0

S-3

HA [No Photo]

3.0

-

4.5

S-4 SPT 4.5 - 6.0



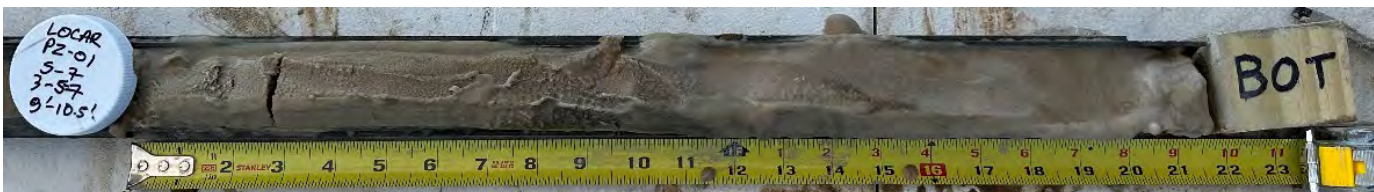
S-5 SPT 6.0 - 7.5



S-6 SPT 7.5 - 9.0



S-7 SPT 9.0 - 10.5



S-8 SPT 13.5 - 15.0



Photo Log: PZ-01

S-1

HA [No Photo]

0.0

-

1.5

S-2

HA [No Photo]

1.5

-

3.0

S-3

HA [No Photo]

3.0

-

4.5

S-4 SPT 4.5 - 6.0



S-5 SPT 6.0 - 7.5



S-6 SPT 7.5 - 9.0



S-7 SPT 9.0 - 10.5



S-8 SPT 13.5 - 15.0



Photo Log: PZ-01, cont.

S-9 SPT 18.5 - 20.0



S-10 SPT 23.5 - 25.0



S-11 SPT 28.5 - 30.0



S-12 SPT 33.5 - 35.0



S-13 SPT 38.5 - 40.0



S-14 SPT 43.5 - 45.0



Photo Log: PZ-01, cont.

S-15 SPT 48.5 - 50.0



S-16 SPT 53.5 - 55.0



S-17 SPT 58.5 - 60.0



S-18 SPT 63.5 - 65.0



S-19 SPT 68.5 - 70.0



S-20 SPT 73.5 - 75.0



Photo Log: PZ-01, cont.



Photo Log: PZ-02

S-1
HA
0.0
-
1.5



PZ-02
S-01
HA
0-1.5
5/25/23

S-2
HA
1.5
-
3.0



PZ-02
S-02
HA
1.5-3
5/25/23

S-3
HA
3.0
-
4.5



PZ-02
S-03
HA
3-4.5
5/25/23

S-4 SPT 4.5 - 6.0



S-5 SPT 6.0 - 7.5



S-6 SPT 7.5 - 9.0



S-7 SPT 9.0 - 10.5



S-8 SPT 13.5 - 15.0



S-9 SPT 18.5 - 20.0



Photo Log: PZ-02, cont.

S-10 SPT 23.5 - 25.0



S-11 SPT 28.5 - 30.0



S-12 SPT 33.5 - 35.0



S-13 SPT 38.5 - 40.0



S-14 SPT 43.5 - 45.0



S-15 SPT 48.5 - 50.0



S-16 SPT 53.5 - 55.0



Photo Log: PZ-02, cont.



Photo Log: PZ-03

S-1
HA
0.0
-
1.5



S-2
HA
1.5
-
3.0



S-3
HA
3.0
-
4.5



S-4 SPT 4.5 - 6.0



S-5 SPT 6.0 - 7.5



S-6 SPT 7.5 - 9.0



S-7 SPT 9.0 - 10.5



S-8 SPT 13.5 - 15.0



S-9 SPT 18.5 - 20.0



Photo Log: PZ-03, cont.

S-10 SPT 23.5 - 25.0



S-11 SPT 28.5 - 30.0



S-12 SPT 33.5 - 35.0



S-13 SPT 38.5 - 40.0



S-14 SPT 43.5 - 45.0



S-15 SPT 48.5 - 50.0



S-16 SPT 53.5 - 55.0



Photo Log: PZ-03, cont.



Photo Log: PZ-04

S-1
HA
0.0
-
1.5



S-2
HA
1.5
-
3.0



S-3
HA
3.0
-
4.5



S-4 **SPT** 4.5 - 6.0



S-5 **SPT** 6.0 - 7.5



S-6 **SPT** 7.5 - 9.0



S-7 **SPT** 9.0 - 10.5



S-8 **SPT** 13.5 - 15.0

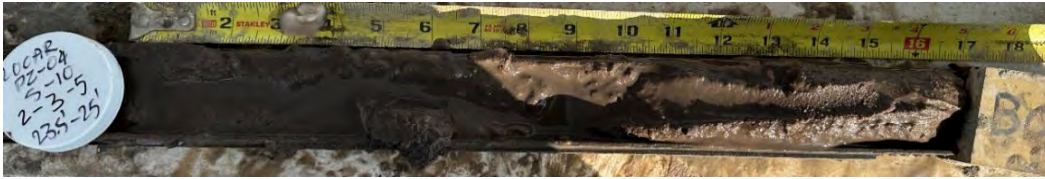


S-9 **SPT** 18.5 - 20.0

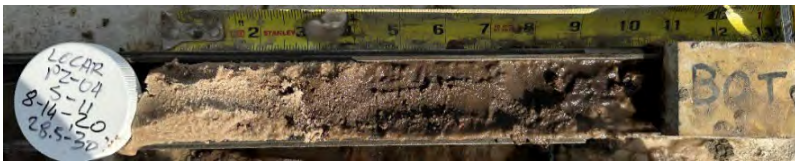


Photo Log: PZ-04, cont.

S-10 SPT 23.5 - 25.0



S-11 SPT 28.5 - 30.0



S-12 SPT 33.5 - 35.0



S-13 SPT 38.5 - 40.0



S-14 SPT 43.5 - 45.0



S-15 SPT 48.5 - 50.0



S-16 SPT 53.5 - 55.0



Photo Log: PZ-04, cont.

S-17 SPT 58.5 - 60.0



S-18 SPT 63.5 - 65.0



S-19 SPT 68.5 - 70.0



S-20 SPT 73.5 - 75.0



S-21 SPT 78.5 - 80.0



Photo Log: PZ-04, cont.



Photo Log: PZ-05

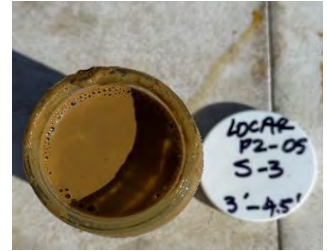
S-1
HA
0.0
-
1.5



S-2
HA
1.5
-
3.0



S-3
HA
3.0
-
4.5



S-4 SPT 4.5 - 6.0



S-5 SPT 6.0 - 7.5



S-6 SPT 7.5 - 9.0



S-7 SPT 9.0 - 10.5



S-8 SPT 13.5 - 15.0



S-9 SPT 18.5 - 20.0



Photo Log: PZ-05, cont.

S-10 SPT 23.5 - 25.0



S-11 SPT 28.5 - 30.0



S-12 SPT 33.5 - 35.0



S-13 SPT 38.5 - 40.0



S-14 SPT 43.5 - 45.0



S-15 SPT 48.5 - 50.0



S-16 SPT 53.5 - 55.0



Photo Log: PZ-05, cont.



Photo Log: PZ-06

S-1 **HA** 0.0 - 1.5
[No photo taken]

S-2 **HA** 1.5 - 3.0
[No photo taken]

S-3 **SPT** 3.0 - 4.5



S-4 **SPT** 4.5 - 6.0



S-5 **SPT** 6.0 - 7.5



S-6 **SPT** 7.5 - 9.0



S-7 **SPT** 9.0 - 10.5



S-8 **SPT** 13.5 - 15.0



Photo Log: PZ-06, cont.

S-9 SPT 18.5 - 20.0



S-10 SPT 23.5 - 25.0



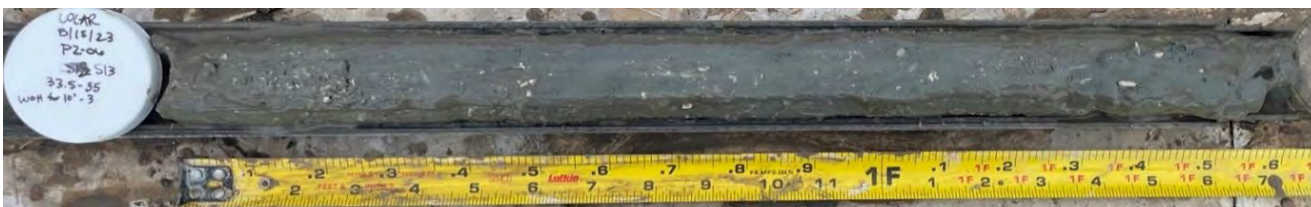
S-11 SPT 28.5 - 30.0



S-12 Shelby 30.0 - 32.0



S-13 SPT 33.5 - 35.0



S-14 SPT 38.5 - 40.0



Photo Log: PZ-06, cont.

S-15 **SPT** 43.5 - 45.0
[No recovery]

S-16 **SPT** 48.5 - 50.0

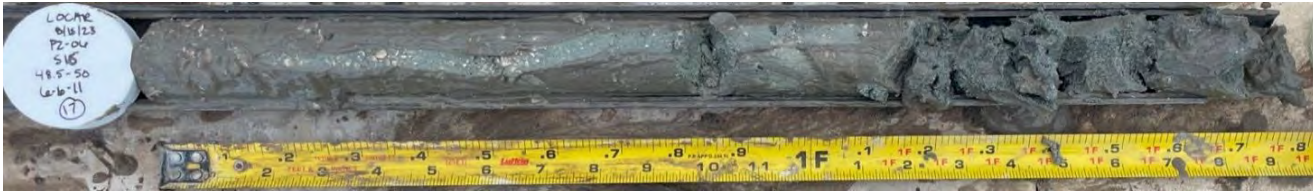


Photo Log: PZ-06, cont.

S-9 SPT 18.5 - 20.0



S-10 SPT 23.5 - 25.0



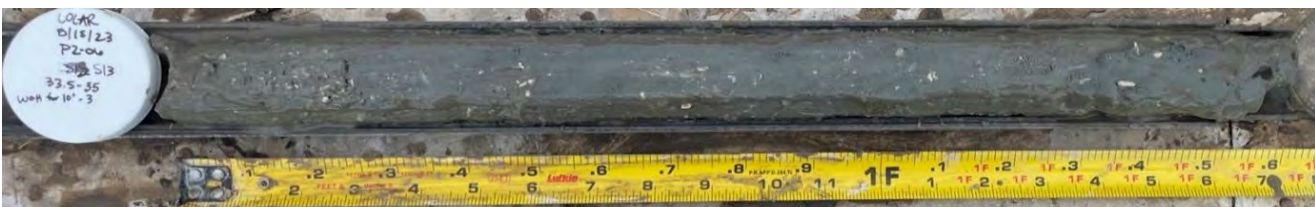
S-11 SPT 28.5 - 30.0



S-12 Shelby 30.0 - 32.0



S-13 SPT 33.5 - 35.0



S-14 SPT 38.5 - 40.0



Photo Log: PZ-06, cont.

S-15 **SPT** 43.5 - 45.0
[No recovery]

S-16 **SPT** 48.5 - 50.0



Photo Log: Double Ring Infiltrometers (DRIs)



	SFWMD Lake Okeechobee Component A Reservoir (LOCAR)	Geotechnical Exploration	Figure: DRI a Finish Date: 5/24/2023
--	---	--------------------------	---

APPENDIX VII

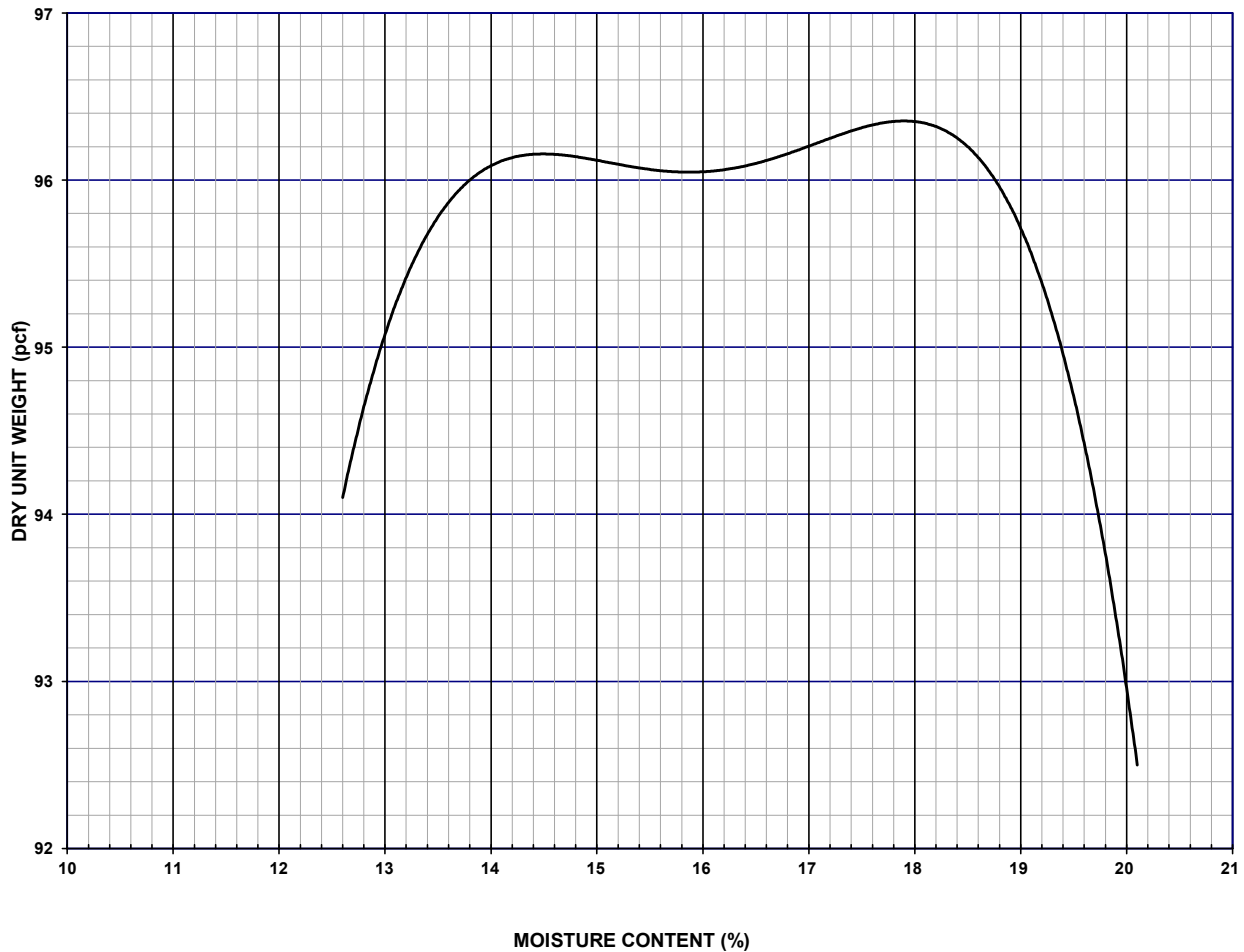
Standard Proctor, Consolidation, and Triaxial Laboratory Test Results



REPORT OF MOISTURE-DENSITY RELATIONSHIP

Project Name: Lake Okeechobee Component A Restoration
 Project Location: Highlands County, Florida
 File Number: 23-60-6363
 Client Name: Tetra Tech

Date Sampled: 6/14/23
 Sampled By: Kodi Aikers
 Date Tested: 6/19/23
 Tested By: DT



TEST RESULTS		
Maximum Dry Density (pcf)	Optimum Moisture Content (%)	Fines Passing #200 Sieve (%)
96.2	18.5	9.1

Curves of 100% Saturation for Specific Gravity Equal to:	
2.60	—————
2.65	- · - · - · -
2.70	-----

SAMPLE NUMBER: SP-1
 TEST METHOD: ASTM D-698
 SAMPLE DESCRIPTION: SAND WITH SILT (SP-SM), gray, fine
 SAMPLE LOCATION: Boring B-07, Sample Depth: 1-3 Feet

Our letters and reports are for the exclusive use of the client to whom they are addressed and shall not be reproduced except in full without the approval of the testing laboratory. The use of our name must receive our written approval. Our letters and reports apply only to the sample tested and/or inspected, and are not indicative of the quantities of apparently identical or similar products.

ARDAMAN & ASSOCIATES, INC. GEOTECHNICAL TESTING LABORATORY

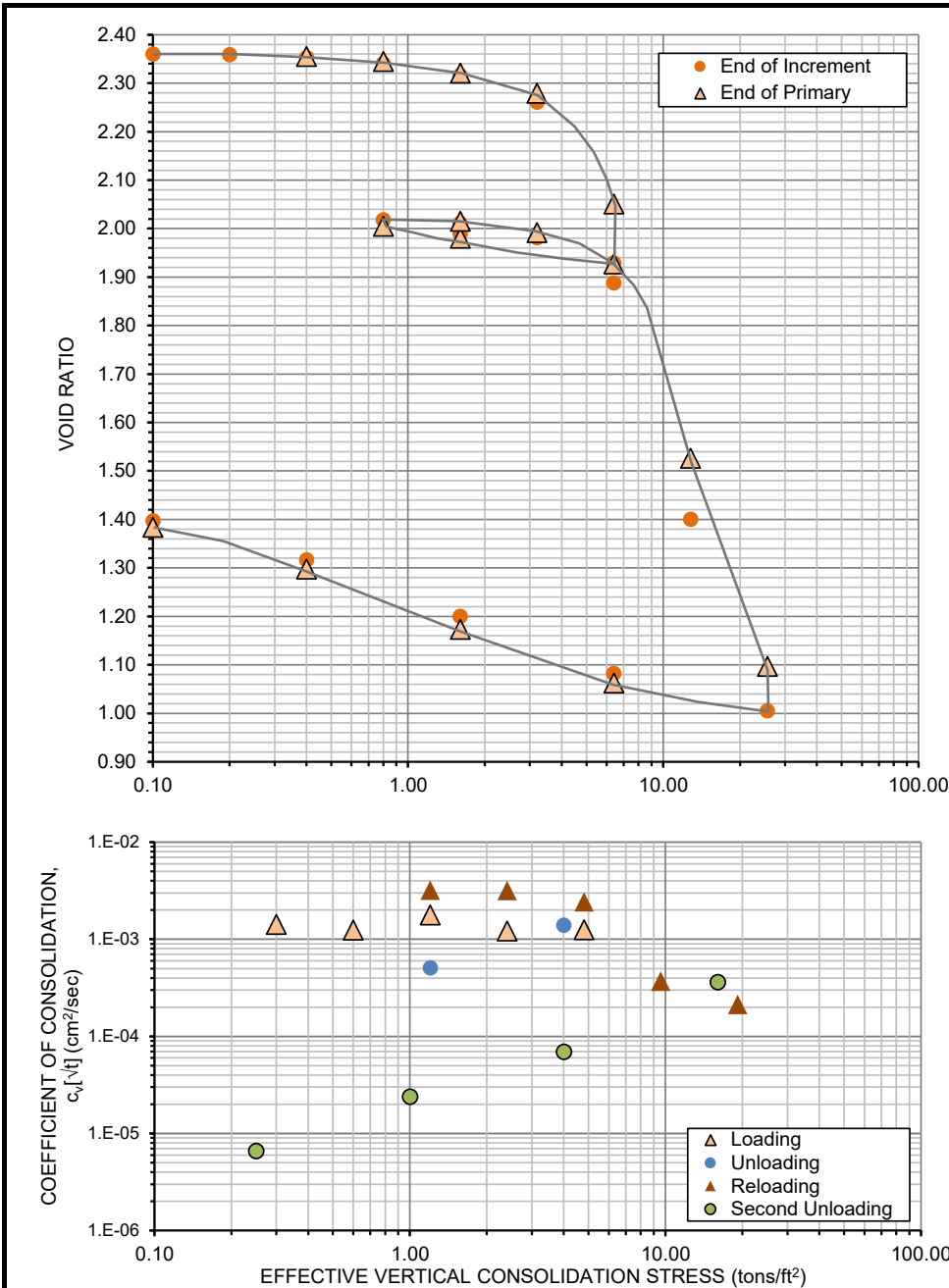
ONE-DIMENSIONAL INCREMENTAL LOADING CONSOLIDATION TEST REPORT

CLIENT: Tetra Tech
 PROJECT: LOCAR
 FILE NO.: 23-60-6363

INCOMING SAMPLE NO.: ----
 BORING: B-02 SAMPLE: S-2
 DEPTH: 57.5 - 58.0 feet

RECEIVED: -----
 TEST STARTED: 06/15/23
 REPORTED: 07/30/23

LAB IDENTIFICATION NO.: 236363/B02AS2
 SAMPLE DESCRIPTION: CLAY WITH SAND (CH), green gray,
with trace shell



TEST METHOD AND PROCEDURES		
ASTM Standard D2435		
Method A	<u> </u>	
Method B	<u> ✓ </u>	
Trimming Method		
Cutting Shoe	<u> ✓ </u>	
Other	<u> </u>	
Initial Sample Diameter (cm):	<u> 7.30 </u>	
TEST CONDITIONS		
Tested at As-received Water Content		
Tested After Inundating		✓
Stress Inundated (tsf)		0.05
Fluid	Tap Water	✓
	Other:	<u> </u>
SPECIMEN CONDITIONS		
Parameter	Initial	Final
Diameter (cm)	5.001	5.001
Height (cm)	1.905	1.357
Water Content (%)	82.1	51.4
Void Ratio	2.364	1.397
Dry Density (lb/ft³)	50.5	70.8
Total Density (lb/ft³)	91.9	107.3
Saturation (%)	94	100
Specific Gravity (ASTM D854)		<u> 2.72 </u>
Measured	<u> ✓ </u>	
Assumed	<u> </u>	
Atterberg Limits (ASTM D4318)		
Liquid Limit	<u> 101 </u>	
Plastic Limit	<u> 21 </u>	
Plasticity Index	<u> 80 </u>	
Comments:		

Particle-Size Distribution		Soil Fraction Passing U.S. Standard Sieve Size (% , dry mass basis)										
Dry Mass (grams)	30.26	Gravel			Coarse Sand	Medium Sand		Fine Sand				
Test Method:	ASTM D1140	✓	3/4"	3/8"	No. 4	No. 10	No. 20	No. 40	No. 60	No. 100	No. 140	No. 200
	ASTM D6913		----	----	----	----	----	----	----	----	----	79.1

The test data and all associated project information presented hereon shall be held in confidence and disclosed to other parties only with the authorization of the Client. Physical and electronic records are kept for a minimum of 7 years. Test samples are kept in storage for at least 10 working days after mailing of the test report, prior to being discarded, unless a longer storage period is requested in writing and accepted by Ardaman & Associates, Inc.

Checked By: TSI
 Date: 07/30/23

ARDAMAN & ASSOCIATES, INC. GEOTECHNICAL TESTING LABORATORY
ONE-DIMENSIONAL INCREMENTAL LOADING CONSOLIDATION TEST REPORT

CLIENT: Tetra Tech
 PROJECT: LOCAR
 FILE NO.: 23-60-6363

INCOMING SAMPLE NO.: -----
 BORING: B-02 SAMPLE: S-2
 DEPTH: 57.5 - 58.0 feet
 LAB IDENTIFICATION NO.: 236363/B02AS2
 SAMPLE DESCRIPTION: CLAY WITH SAND (CH), green gray, with trace shell

RECEIVED: -----
 TEST STARTED: 06/15/23
 REPORTED: 07/30/23

Effective Stress (tsf)	Dial Reading (inch)			Time (seconds)		Coefficient of Consolidation, c_v (cm ² /sec)		Increment Average Effective Stress (tsf)	Height (inch)		Void Ratio		Strain (%)		Secondary Compression	
	Initial	End of Primary	End of Increment	t_{90}	t_{50}	c_v [\sqrt{t}]	c_v [$\log t$]		End of Primary	End of Increment	End of Primary	End of Increment	End of Primary	End of Increment	C_{α} (%)	$C_{\alpha e}$
0.00	0.0057	0.0057	0.0057	---	---	---	---	---	0.7500	0.7500	2.364	2.364	0.00	0.00	---	----
0.05	0.0057	0.0063	0.0063	---	---	---	---	0.025	0.7494	0.7494	2.361	2.361	0.08	0.08	---	----
0.10	0.0065	0.0067	0.0067	---	---	---	---	0.075	0.7492	0.7492	2.360	2.360	0.11	0.11	---	----
0.20	0.0074	0.0077	0.0077	---	---	---	---	0.150	0.7489	0.7489	2.359	2.359	0.15	0.15	---	----
0.40	0.0083	0.0091	0.0096	540	---	1.4E-03	---	0.300	0.7482	0.7476	2.356	2.353	0.25	0.32	0.04	0.0014
0.80	0.0105	0.0123	0.0132	614	---	1.2E-03	---	0.600	0.7458	0.7449	2.345	2.341	0.56	0.68	0.07	0.0022
1.60	0.0145	0.0189	0.0201	425	---	1.8E-03	---	1.200	0.7405	0.7393	2.321	2.316	1.27	1.43	0.08	0.0028
3.20	0.0218	0.0299	0.0340	606	---	1.2E-03	---	2.400	0.7312	0.7271	2.279	2.261	2.51	3.05	0.29	0.0098
6.40	0.0361	0.0830	0.1101	540	---	1.3E-03	---	4.800	0.6802	0.6531	2.051	1.929	9.31	12.92	1.24	0.0417
1.60	0.1082	0.0969	0.0947	425	75	1.4E-03	1.8E-03	4.000	0.6644	0.6666	1.980	1.990	11.41	11.12	---	----
0.80	0.0933	0.0899	0.0870	1,206	---	5.1E-04	---	1.200	0.6700	0.6729	2.005	2.018	10.67	10.28	---	----
1.60	0.0879	0.0886	0.0894	194	---	3.2E-03	---	1.200	0.6722	0.6714	2.015	2.011	10.37	10.48	0.07	0.0022
3.20	0.0911	0.0955	0.0978	194	40	3.2E-03	3.6E-03	2.400	0.6670	0.6647	1.992	1.981	11.07	11.37	0.13	0.0044
6.40	0.0997	0.1117	0.1205	245	---	2.4E-03	---	4.800	0.6527	0.6439	1.927	1.888	12.97	14.15	0.55	0.0185
12.80	0.1275	0.2081	0.2363	1,354	380	3.7E-04	2.9E-04	9.600	0.5633	0.5351	1.527	1.400	24.89	28.65	1.39	0.0468
25.60	0.2392	0.3068	0.3272	1,620	500	2.1E-04	1.5E-04	19.200	0.4675	0.4471	1.097	1.005	37.67	40.39	0.85	0.0286
6.40	0.3251	0.3124	0.3080	778	270	3.6E-04	2.4E-04	16.000	0.4598	0.4642	1.062	1.082	38.69	38.11	---	----
1.60	0.3063	0.2860	0.2799	4,440	1,470	6.9E-05	4.8E-05	4.000	0.4845	0.4906	1.173	1.200	35.40	34.59	---	----
0.40	0.2797	0.2580	0.2538	14,400	4,075	2.4E-05	1.9E-05	1.000	0.5123	0.5165	1.298	1.317	31.69	31.13	---	----
0.10	0.2531	0.2381	0.2352	56,920	---	1.8E-03	---	0.250	0.5315	0.5344	1.384	1.397	29.13	28.75	---	----

The test data and all associated project information presented hereon shall be held in confidence and disclosed to other parties only with the authorization of the Client. Physical and electronic records are kept for a minimum of 7 years. Test samples are kept in storage for at least 10 working days after mailing of the test report, prior to being discarded, unless a longer storage period is requested in writing and accepted by Ardaman & Associates, Inc.

Checked By: TSI
 Date: 07/30/23

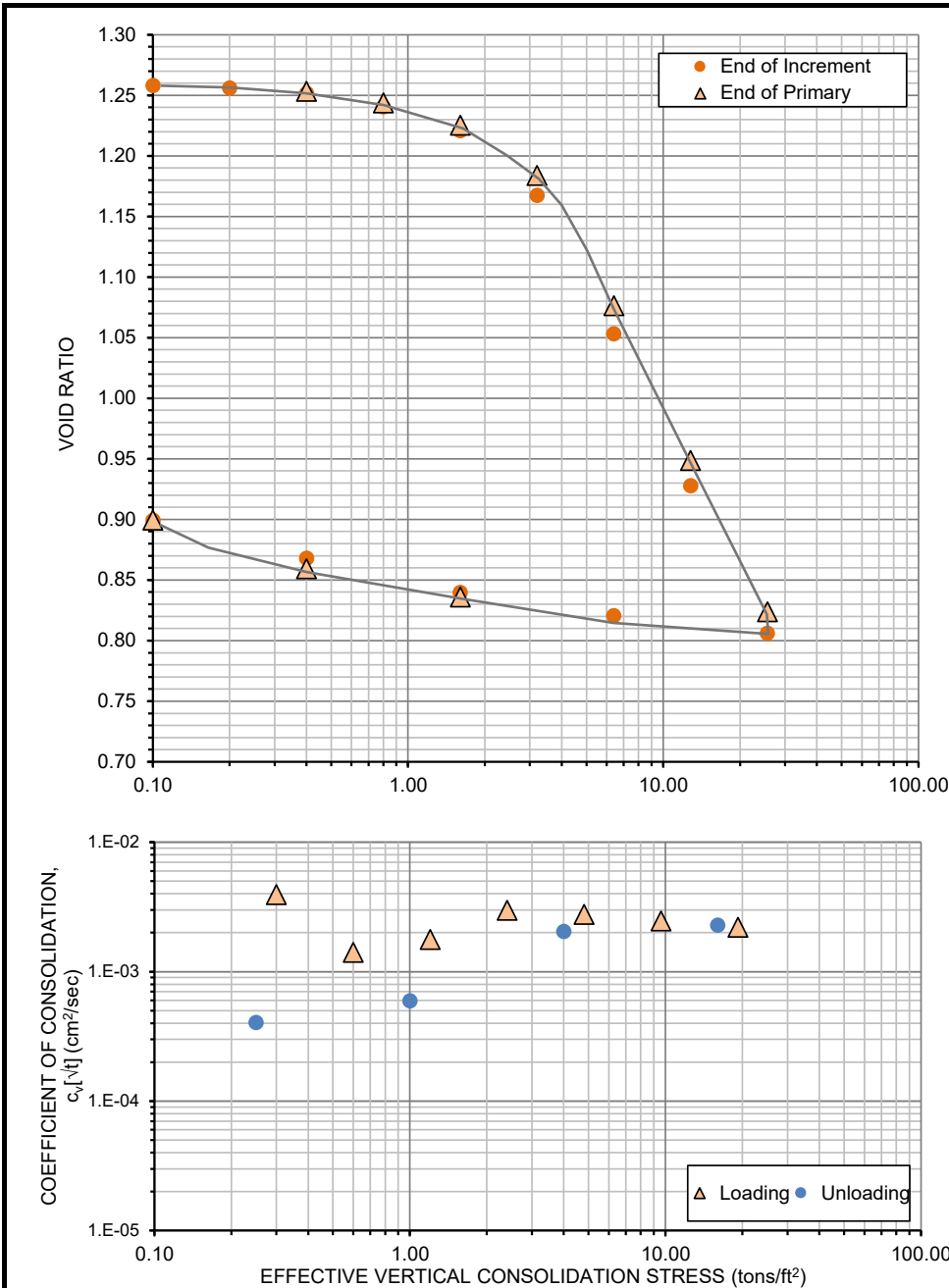
ARDAMAN & ASSOCIATES, INC. GEOTECHNICAL TESTING LABORATORY

ONE-DIMENSIONAL INCREMENTAL LOADING CONSOLIDATION TEST REPORT

CLIENT: Tetra Tech
 PROJECT: LOCAR
 FILE NO.: 23-60-6363

INCOMING SAMPLE NO.: ----
 BORING: B-05 SAMPLE: S-25
 DEPTH: 48.0 - 50.0 feet
 LAB IDENTIFICATION NO.: 236363/B05S25
 SAMPLE DESCRIPTION: SANDY CLAY (CH), green gray

RECEIVED: -----
 TEST STARTED: 06/15/23
 REPORTED: 07/30/23



TEST METHOD AND PROCEDURES

ASTM Standard D2435
 Method A _____
 Method B ✓
 Trimming Method _____
 Cutting Shoe ✓
 Other _____
 Initial Sample Diameter (cm): 7.30

TEST CONDITIONS

Tested at As-received Water Content	
Tested After Inundating	<u>✓</u>
Stress Inundated (tsf)	<u>0.05</u>
Fluid	Tap Water <u>✓</u>
	Other: _____

SPECIMEN CONDITIONS

Parameter	Initial	Final
Diameter (cm)	5.001	5.001
Height (cm)	1.905	1.601
Water Content (%)	45.0	33.1
Void Ratio	1.261	0.899
Dry Density (lb/ft³)	75.1	89.4
Total Density (lb/ft³)	108.9	119.0
Saturation (%)	97	100

Specific Gravity (ASTM D854) 2.72
 Measured _____
 Assumed ✓
 Atterberg Limits (ASTM D4318)
 Liquid Limit 55
 Plastic Limit 20
 Plasticity Index 35

Comments:

Particle-Size Distribution		Soil Fraction Passing U.S. Standard Sieve Size (% , dry mass basis)										
Dry Mass (grams)	45.03	Gravel			Coarse Sand	Medium Sand			Fine Sand			
Test Method:	ASTM D1140	3/4"	3/8"	No. 4	No. 10	No. 20	No. 40	No. 60	No. 100	No. 140	No. 200	
	<u>✓</u>	----	----	----	----	----	----	----	----	----	59.0	

The test data and all associated project information presented hereon shall be held in confidence and disclosed to other parties only with the authorization of the Client. Physical and electronic records are kept for a minimum of 7 years. Test samples are kept in storage for at least 10 working days after mailing of the test report, prior to being discarded, unless a longer storage period is requested in writing and accepted by Ardaman & Associates, Inc.

Checked By: TSI
 Date: 07/30/23

ARDAMAN & ASSOCIATES, INC. GEOTECHNICAL TESTING LABORATORY
ONE-DIMENSIONAL INCREMENTAL LOADING CONSOLIDATION TEST REPORT

CLIENT: Tetra Tech
 PROJECT: LOCAR
 FILE NO.: 23-60-6363

RECEIVED: -----
 TEST STARTED: 06/15/23
 REPORTED: 07/30/23

INCOMING SAMPLE NO.: -----

BORING: B-05 SAMPLE: S-25

DEPTH: 48.0 - 50.0 feet

LAB IDENTIFICATION NO.: 236363/B05S25

SAMPLE DESCRIPTION: SANDY CLAY (CH), green gray

Effective Stress (tsf)	Dial Reading (inch)			Time (seconds)		Coefficient of Consolidation, c_v (cm ² /sec)		Increment Average Effective Stress (tsf)	Height (inch)		Void Ratio		Strain (%)		Secondary Compression	
	Initial	End of Primary	End of Increment	t_{90}	t_{50}	c_v [\sqrt{t}]	c_v [log t]		End of Primary	End of Increment	End of Primary	End of Increment	End of Primary	End of Increment	C_{α} (%)	$C_{\alpha e}$
0.00	0.0053	0.0053	0.0053	---	---	---	---	---	0.7500	0.7500	1.261	1.261	0.00	0.00	----	----
0.05	0.0053	0.0058	0.0058	---	---	---	---	0.025	0.7495	0.7495	1.259	1.259	0.07	0.07	----	----
0.10	0.0061	0.0064	0.0064	---	---	---	---	0.075	0.7492	0.7492	1.258	1.258	0.11	0.11	----	----
0.20	0.0068	0.0075	0.0075	---	---	---	---	0.150	0.7485	0.7485	1.256	1.256	0.20	0.20	----	----
0.40	0.0081	0.0090	0.0095	194	---	3.9E-03	---	0.300	0.7476	0.7471	1.253	1.252	0.32	0.39	0.03	0.0006
0.80	0.0104	0.0131	0.0141	540	---	1.4E-03	---	0.600	0.7444	0.7434	1.244	1.241	0.74	0.88	0.06	0.0011
1.60	0.0153	0.0204	0.0219	425	---	1.8E-03	---	1.200	0.7383	0.7368	1.225	1.221	1.56	1.76	0.11	0.0021
3.20	0.0236	0.0358	0.0413	245	---	3.0E-03	---	2.400	0.7246	0.7191	1.184	1.167	3.39	4.12	0.35	0.0066
6.40	0.0434	0.0736	0.0813	245	---	2.8E-03	---	4.800	0.6889	0.6812	1.076	1.053	8.15	9.17	0.44	0.0084
12.80	0.0839	0.1186	0.1255	245	---	2.5E-03	---	9.600	0.6465	0.6396	0.949	0.928	13.80	14.72	0.40	0.0076
25.60	0.1284	0.1629	0.1688	240	---	2.2E-03	---	19.200	0.6051	0.5992	0.824	0.806	19.32	20.11	0.40	0.0076
6.40	0.1670	0.1625	0.1622	217	---	2.3E-03	---	16.000	0.6037	0.6040	0.820	0.820	19.51	19.47	----	----
1.60	0.1601	0.1550	0.1537	246	---	2.0E-03	---	4.000	0.6091	0.6104	0.836	0.840	18.79	18.61	----	----
0.40	0.1522	0.1457	0.1428	866	---	5.9E-04	---	1.000	0.6169	0.6198	0.859	0.868	17.75	17.36	----	----
0.10	0.1422	0.1318	0.1318	1,325	---	4.0E-04	---	0.250	0.6302	0.6302	0.899	0.899	15.97	15.97	----	----

The test data and all associated project information presented hereon shall be held in confidence and disclosed to other parties only with the authorization of the Client. Physical and electronic records are kept for a minimum of 7 years. Test samples are kept in storage for at least 10 working days after mailing of the test report, prior to being discarded, unless a longer storage period is requested in writing and accepted by Ardaman & Associates, Inc.

Checked By: TSI

Date: 07/30/23

ARDAMAN & ASSOCIATES, INC. GEOTECHNICAL TESTING LABORATORY

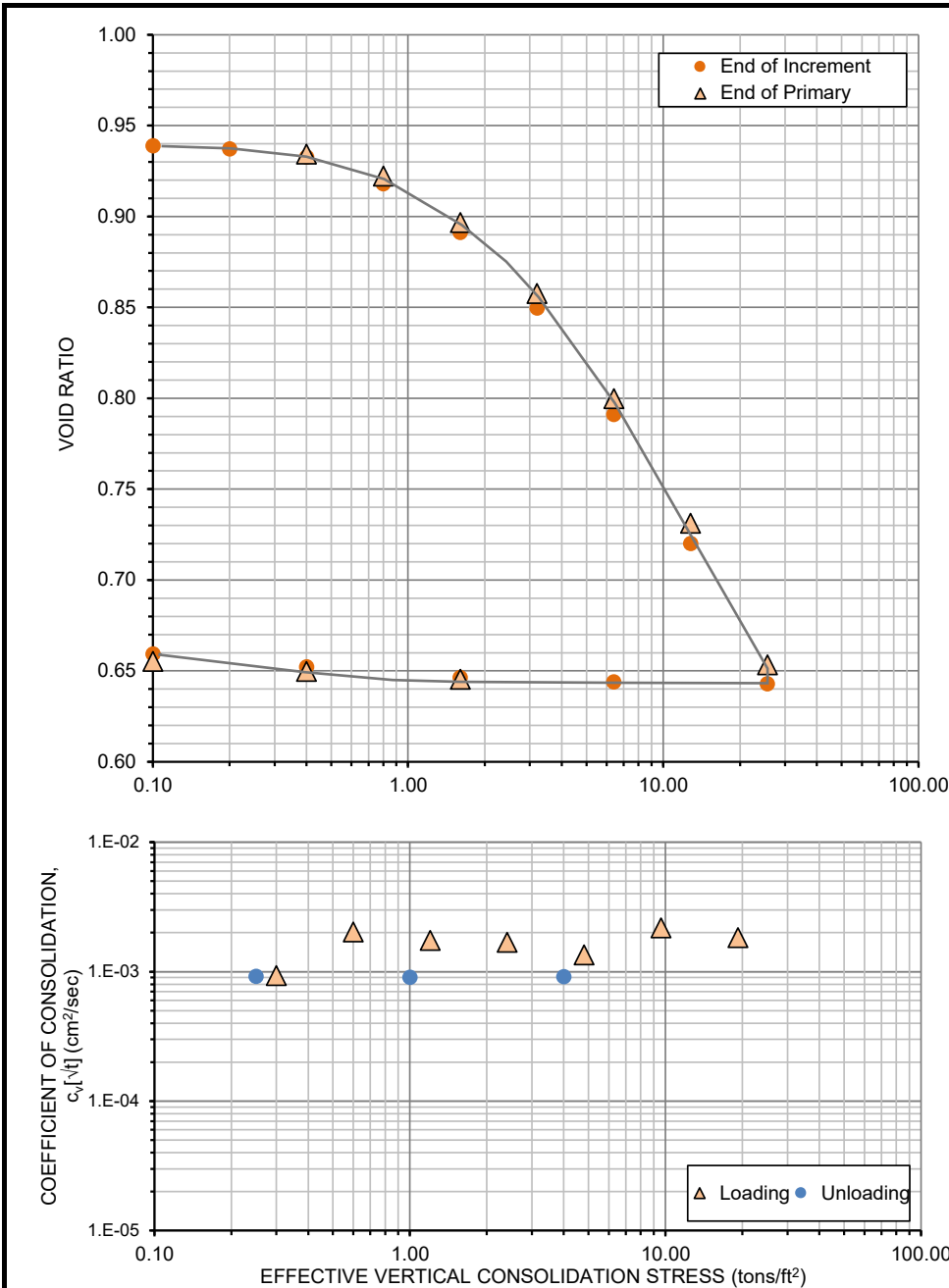
ONE-DIMENSIONAL INCREMENTAL LOADING CONSOLIDATION TEST REPORT

CLIENT: Tetra Tech
 PROJECT: LOCAR
 FILE NO.: 23-60-6363

INCOMING SAMPLE NO.: ----
 BORING: B-06 SAMPLE: S-16
 DEPTH: 52.0 - 54.0 feet

RECEIVED: -----
 TEST STARTED: 06/15/23
 REPORTED: 07/30/23

LAB IDENTIFICATION NO.: 236363/B06S16
 SAMPLE DESCRIPTION: CLAYEY SAND (SC), light gray,
fine, with trace shell, trace phosphate



TEST METHOD AND PROCEDURES

ASTM Standard D2435
 Method A _____
 Method B ✓
 Trimming Method
 Cutting Shoe ✓
 Other _____
 Initial Sample Diameter (cm): 7.30

TEST CONDITIONS

Tested at As-received Water Content	
Tested After Inundating	<u>✓</u>
Stress Inundated (tsf)	<u>0.05</u>
Fluid	Tap Water <u>✓</u>
	Other: _____

SPECIMEN CONDITIONS

Parameter	Initial	Final
Diameter (cm)	5.001	5.001
Height (cm)	1.905	1.627
Water Content (%)	30.9	23.6
Void Ratio	0.943	0.659
Dry Density (lb/ft³)	87.4	102.3
Total Density (lb/ft³)	114.4	126.5
Saturation (%)	89	97

Specific Gravity (ASTM D854) 2.72
 Measured ✓
 Assumed _____
 Atterberg Limits (ASTM D4318)
 Liquid Limit 33
 Plastic Limit 15
 Plasticity Index 18

Comments:

Particle-Size Distribution		Soil Fraction Passing U.S. Standard Sieve Size (% , dry mass basis)										
Dry Mass (grams)	52.40	Gravel			Coarse Sand	Medium Sand			Fine Sand			
Test Method:	ASTM D1140	<u>✓</u>	3/4"	3/8"	No. 4	No. 10	No. 20	No. 40	No. 60	No. 100	No. 140	No. 200
		ASTM D6913		----	----	----	----	----	----	----	----	----

The test data and all associated project information presented hereon shall be held in confidence and disclosed to other parties only with the authorization of the Client. Physical and electronic records are kept for a minimum of 7 years. Test samples are kept in storage for at least 10 working days after mailing of the test report, prior to being discarded, unless a longer storage period is requested in writing and accepted by Ardaman & Associates, Inc.

Checked By: TSI
 Date: 07/30/23

**ARDAMAN & ASSOCIATES, INC. GEOTECHNICAL TESTING LABORATORY
ONE-DIMENSIONAL INCREMENTAL LOADING CONSOLIDATION TEST REPORT**

CLIENT: Tetra Tech
PROJECT: LOCAR
FILE NO.: 23-60-6363

RECEIVED: -----
TEST STARTED: 06/15/23
REPORTED: 07/30/23

INCOMING SAMPLE NO.: -----
BORING: B-06 SAMPLE: S-16
DEPTH: 52.0 - 54.0 feet
LAB IDENTIFICATION NO.: 236363/B06S16
SAMPLE DESCRIPTION: CLAYEY SAND (SC), light gray, fine, with trace shell,
trace phosphate

Effective Stress (tsf)	Dial Reading (inch)			Time (seconds)		Coefficient of Consolidation, c_v (cm ² /sec)		Increment Average Effective Stress (tsf)	Height (inch)		Void Ratio		Strain (%)		Secondary Compression	
	Initial	End of Primary	End of Increment	t_{90}	t_{50}	c_v [\sqrt{t}]	c_v [log t]		End of Primary	End of Increment	End of Primary	End of Increment	End of Primary	End of Increment	C_{α} (%)	$C_{\alpha e}$
0.00	0.0060	0.0060	0.0060	---	---	---	---	---	0.7500	0.7500	0.943	0.943	0.00	0.00	----	----
0.05	0.0060	0.0070	0.0070	---	---	---	---	0.025	0.7490	0.7490	0.940	0.940	0.13	0.13	----	----
0.10	0.0075	0.0079	0.0079	---	---	---	---	0.075	0.7486	0.7486	0.939	0.939	0.19	0.19	----	----
0.20	0.0083	0.0090	0.0090	---	---	---	---	0.150	0.7479	0.7479	0.937	0.937	0.28	0.28	----	----
0.40	0.0097	0.0108	0.0114	821	---	9.3E-04	---	0.300	0.7468	0.7462	0.934	0.933	0.42	0.51	0.05	0.0009
0.80	0.0123	0.0163	0.0180	375	---	2.0E-03	---	0.600	0.7422	0.7405	0.922	0.918	1.04	1.27	0.11	0.0021
1.60	0.0192	0.0274	0.0295	425	---	1.7E-03	---	1.200	0.7323	0.7302	0.897	0.891	2.36	2.64	0.14	0.0027
3.20	0.0312	0.0442	0.0473	425	---	1.7E-03	---	2.400	0.7172	0.7141	0.858	0.850	4.37	4.79	0.19	0.0037
6.40	0.0495	0.0687	0.0721	505	---	1.3E-03	---	4.800	0.6949	0.6915	0.800	0.791	7.35	7.80	0.21	0.0041
12.80	0.0747	0.0978	0.1021	290	---	2.2E-03	---	9.600	0.6684	0.6641	0.731	0.720	10.88	11.45	0.21	0.0041
25.60	0.1050	0.1308	0.1348	317	---	1.8E-03	---	19.200	0.6383	0.6343	0.653	0.643	14.89	15.43	0.27	0.0052
6.40	0.1302	0.1298	0.1298	---	---	---	---	16.000	0.6347	0.6347	0.644	0.644	15.37	15.37	----	----
1.60	0.1259	0.1253	0.1250	605	---	9.1E-04	---	4.000	0.6353	0.6356	0.645	0.646	15.30	15.25	----	----
0.40	0.1215	0.1202	0.1192	614	---	9.0E-04	---	1.000	0.6369	0.6379	0.650	0.652	15.08	14.95	----	----
0.10	0.1174	0.1162	0.1146	606	---	9.2E-04	---	0.250	0.6391	0.6407	0.655	0.659	14.79	14.58	----	----

The test data and all associated project information presented hereon shall be held in confidence and disclosed to other parties only with the authorization of the Client. Physical and electronic records are kept for a minimum of 7 years. Test samples are kept in storage for at least 10 working days after mailing of the test report, prior to being discarded, unless a longer storage period is requested in writing and accepted by Ardaman & Associates, Inc.

Checked By: TSI

Date: 07/30/23

ARDAMAN & ASSOCIATES, INC. GEOTECHNICAL TESTING LABORATORY
ONE-DIMENSIONAL INCREMENTAL LOADING CONSOLIDATION TEST REPORT

CLIENT: TETRA TECH
 PROJECT: LOCAR
 FILE NO.: 23-60-6363

INCOMING SAMPLE NO.: -----
 BORING: B-23 SAMPLE: S-23A
 DEPTH: 60.0 - 62.0 feet

RECEIVED: -----
 TEST STARTED: 08/31/23
 REPORTED: 10/03/23

LAB IDENTIFICATION NO.: 236363/B23S23A
 SAMPLE DESCRIPTION: GREEN GRAY CLAY WITH SAND
AND TRACE SHELL FRAGMENTS

Effective Stress (tsf)	Dial Reading (inch)			Time (seconds)		Coefficient of Consolidation, c_v (cm ² /sec)		Increment Average Effective Stress (tsf)	Height (inch)		Void Ratio		Strain (%)		Secondary Compression	
	Initial	End of Primary	End of Increment	t_{90}	t_{50}	$c_v [\sqrt{t}]$	$c_v [\log t]$		End of Primary	End of Increment	End of Primary	End of Increment	End of Primary	End of Increment	C_{α} (%)	$C_{\alpha e}$
0.00	0.0105	0.0105	0.0105	---	---	---	---	---	0.7500	0.7500	1.529	1.529	0.00	0.00	---	---
0.05	0.0105	0.0117	0.0117	---	---	---	---	0.025	0.7488	0.7488	1.525	1.525	0.16	0.16	---	---
0.10	0.0122	0.0126	0.0126	---	---	---	---	0.075	0.7484	0.7484	1.524	1.524	0.21	0.21	---	---
0.20	0.0132	0.0136	0.0136	---	---	---	---	0.150	0.7480	0.7480	1.522	1.522	0.27	0.27	---	---
0.40	0.0144	0.0148	0.0152	---	---	---	---	0.300	0.7476	0.7472	1.521	1.520	0.32	0.37	---	---
0.80	0.0166	0.0174	0.0181	---	---	---	---	0.600	0.7464	0.7457	1.517	1.514	0.48	0.57	---	---
1.60	0.0202	0.0221	0.0229	1,206	---	6.3E-04	---	1.200	0.7438	0.7430	1.508	1.505	0.83	0.93	0.07	0.0017
3.20	0.0254	0.0286	0.0304	540	---	1.4E-03	---	2.400	0.7398	0.7380	1.495	1.489	1.36	1.60	0.12	0.0030
6.40	0.0336	0.0478	0.0572	425	---	1.7E-03	---	4.800	0.7238	0.7144	1.441	1.409	3.49	4.75	0.60	0.0152
12.70	0.0605	0.1177	0.1410	290	95	2.2E-03	1.5E-03	9.550	0.6572	0.6339	1.216	1.137	12.37	15.48	0.80	0.0202
25.30	0.1434	0.2102	0.2244	540	122	9.1E-04	9.3E-04	19.000	0.5671	0.5529	0.912	0.864	24.39	26.28	0.53	0.0134
6.40	0.2219	0.2158	0.2140	245	---	1.7E-03	---	15.850	0.5590	0.5608	0.885	0.891	25.47	25.23	---	---
1.60	0.2110	0.2022	0.1975	735	300	5.9E-04	3.4E-04	4.000	0.5696	0.5743	0.921	0.937	24.05	23.43	---	---
0.40	0.1957	0.1876	0.1831	4,206	1,900	1.1E-04	5.6E-05	1.000	0.5824	0.5869	0.964	0.979	22.35	21.75	---	---
0.10	0.1822	0.1765	0.1750	56,182	---	8.5E-06	---	0.250	0.5926	0.5941	0.998	1.003	20.99	20.79	---	---

The test data and all associated project information presented hereon shall be held in confidence and disclosed to other parties only with the authorization of the Client. Physical and electronic records are kept for a minimum of 7 years. Test samples are kept in storage for at least 10 working days after mailing of the test report, prior to being discarded, unless a longer storage period is requested in writing and accepted by Ardaman & Associates, Inc.

Checked By: TSI
 Date: 10/03/23

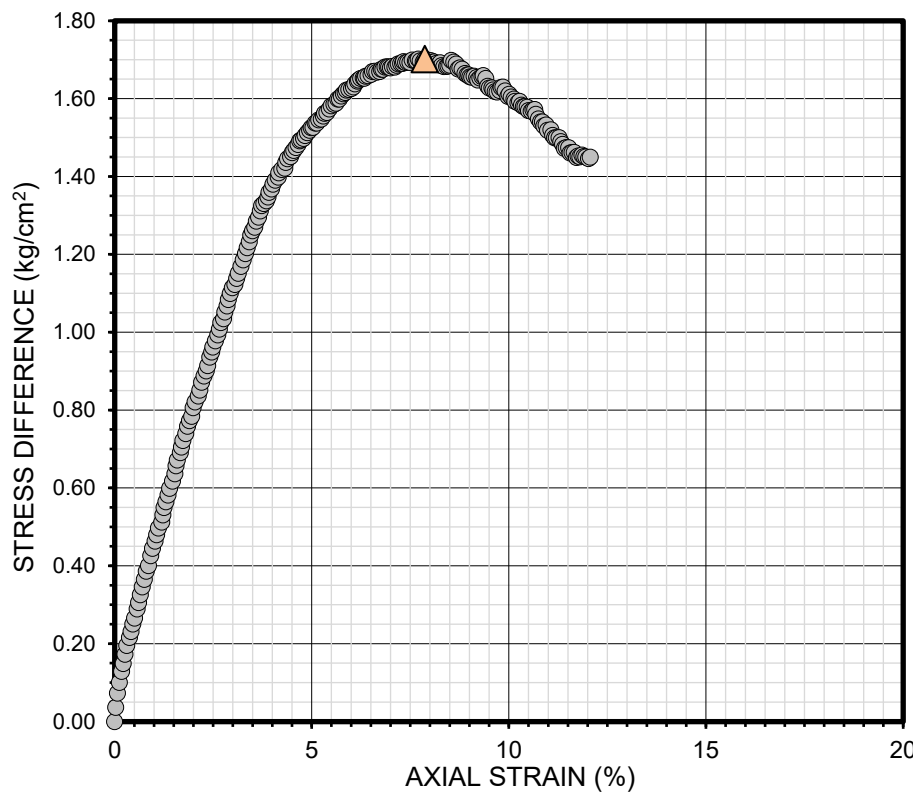
ARDAMAN & ASSOCIATES, INC. GEOTECHNICAL TESTING LABORATORY UNCONSOLIDATED UNDRAINED TRIAXIAL COMPRESSION TEST REPORT

CLIENT: Tetra Tech
 PROJECT: LOCAR
 FILE NO.: 23-60-6363

INCOMING SAMPLE NO.: -----
 BORING: B-07 SAMPLE: Grab Sample 1
 DEPTH: 1 - 3 feet; meters
 LABORATORY IDENTIFICATION NO.: 236363/B07
 SAMPLE DESCRIPTION: SAND WITH SILT (SP-SM),
 Gray, fine. Specimen remolded at target molding water
 content of 19.3% to target initial dry density of 96.2 pcf.

DATE SAMPLE RECEIVED: ----
 DATE TEST SET-UP: 07/10/23
 DATE REPORTED: 07/28/23

Specimen Dimensions			Initial Conditions			Test Conditions			at $(\sigma_1 - \sigma_3)_{max}$			
H (cm)	D (cm)	[H/D]	w_c (%)	γ_d (lb/ft ³)	S (%)	σ_c (kg/cm ²)	Strain Rate, $\dot{\epsilon}$		ϵ_a (%)	Compressive Strength (kg/cm ²)	σ_1 (kg/cm ²)	σ_3 (kg/cm ²)
							(cm/minute)	(%/minute)				
7.016	3.587	2.0	18.7	96.7	69	0.122	0.0702	1.00	7.9	1.702	1.824	0.122
Membrane Correction Made: <input type="checkbox"/> Yes <input checked="" type="checkbox"/> No												



TEST PROCEDURE: ASTM D2850

SAMPLE TYPE

Type	Diameter (inch)
<input type="checkbox"/> Undisturbed	
<input type="checkbox"/> Rock Core	
<input checked="" type="checkbox"/> Compacted	1.41
<input checked="" type="checkbox"/> Tamped Uniform Lifts No. of Lifts: <u>6</u>	
<input type="checkbox"/> Kneading No. of Lifts: _____ Spring: _____ lb. Blows per Lift: _____	

G_s: 2.68 Assumed Measured

FAILURE SKETCH

Diagonal Plane
 Bulging
 Combination
 Other

Particle-Size Analysis		U.S. Standard Sieve Size	Gravel			Coarse Sand	Medium Sand		Fine Sand			
Particle-Size Analysis			3/4"	3/8"	No. 4	No. 10	No. 20	No. 40	No. 60	No. 100	No. 140	No. 200
<input type="checkbox"/> ASTM D6913												
<input checked="" type="checkbox"/> ASTM D1140-Method B												
Dry Mass (g)	109.77	Soil Passing (% dry mass)	---	---	---	---	---	---	---	---	---	9.1

The test data and all associated project information presented hereon shall be held in confidence and disclosed to other parties only with the authorization of the Client. Physical and electronic records of each project are kept for a minimum of 7 years. Test samples are kept in storage for at least 10 working days after mailing of the test report, prior to being discarded, unless a longer storage period is requested in writing and accepted by Ardaman & Associates, Inc.

Where: H = Specimen height; D = Specimen diameter; w_c = Water content (ASTM D2216); γ_d = Dry density; S = Saturation; σ_c = Isotropic confining stress; $\dot{\epsilon}$ = Vertical displacement rate; ϵ_a = Axial strain; σ_1 = Major principal stress; σ_3 = Minor principal stress; and G_s = Specific gravity.

Checked By: TSI Date: 07/28/23

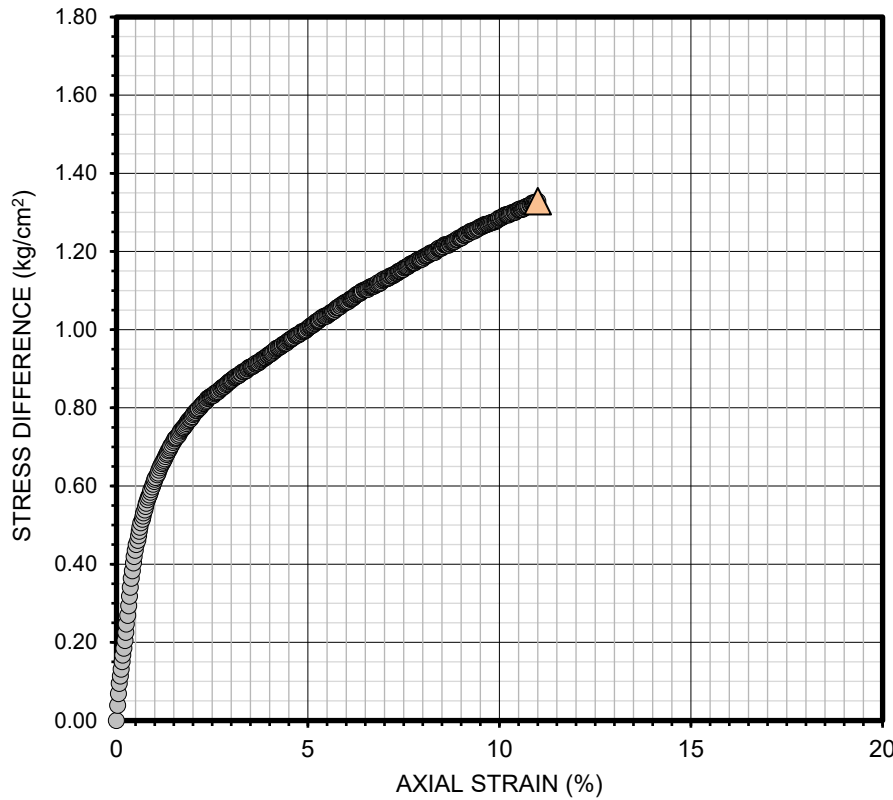
ARDAMAN & ASSOCIATES, INC. GEOTECHNICAL TESTING LABORATORY UNCONSOLIDATED UNDRAINED TRIAXIAL COMPRESSION TEST REPORT

CLIENT: Tetra Tech
 PROJECT: LOCAR
 FILE NO.: 23-60-6363

INCOMING SAMPLE NO.: -----
 BORING: B-02 SAMPLE: S-3
 DEPTH: 61.5 - 62.0 feet; meters
 LABORATORY IDENTIFICATION NO.: 236363/B02A
 SAMPLE DESCRIPTION: SILTY SAND (SM), gray, fine
Test terminated at 11.0% axial strain because of leak in
triaxial cell.

DATE SAMPLE RECEIVED: ----
 DATE TEST SET-UP: 07/05/23
 DATE REPORTED: 07/28/23

Specimen Dimensions			Initial Conditions			Test Conditions			at $(\sigma_1 - \sigma_3)_{max}$			
H (cm)	D (cm)	[H/D]	w_c (%)	γ_d (lb/ft ³)	S (%)	σ_c (kg/cm ²)	Strain Rate, $\dot{\epsilon}$		ϵ_a (%)	Compressive Strength (kg/cm ²)	σ_1 (kg/cm ²)	σ_3 (kg/cm ²)
							(cm/minute)	(%/minute)				
14.404	7.213	2.0	28.9	95.1	100	1.465	0.0718	0.50	11.0	1.329	2.794	1.465
Membrane Correction Made: <input type="checkbox"/> Yes <input checked="" type="checkbox"/> No												



TEST PROCEDURE: ASTM D2850

SAMPLE TYPE

Type	Diameter (inch)
<input checked="" type="checkbox"/> Undisturbed	2.875
<input type="checkbox"/> Rock Core	
<input type="checkbox"/> Compacted	
<input type="checkbox"/> Tamped Uniform Lifts No. of Lifts: _____	
<input type="checkbox"/> Kneading No. of Lifts: _____ Spring: _____ lb. Blows per Lift: _____	
G _s : <u>2.72</u>	<input checked="" type="checkbox"/> Assumed <input type="checkbox"/> Measured

FAILURE SKETCH

Diagonal Plane
 Bulging
 Combination
 Other

Particle-Size Analysis		U.S. Standard Sieve Size	Gravel			Coarse Sand	Medium Sand		Fine Sand			
Particle-Size Analysis			3/4"	3/8"	No. 4	No. 10	No. 20	No. 40	No. 60	No. 100	No. 140	No. 200
<input checked="" type="checkbox"/> ASTM D6913												
<input type="checkbox"/> ASTM D1140-Method B												
Dry Mass (g)	234.20	Soil Passing (% dry mass)	100	99.8	99.5	97.5	94.9	94.0	92.8	88.0	41.9	26.4

The test data and all associated project information presented hereon shall be held in confidence and disclosed to other parties only with the authorization of the Client. Physical and electronic records of each project are kept for a minimum of 7 years. Test samples are kept in storage for at least 10 working days after mailing of the test report, prior to being discarded, unless a longer storage period is requested in writing and accepted by Ardaman & Associates, Inc.

Where: H = Specimen height; D = Specimen diameter; w_c = Water content (ASTM D2216); γ_d = Dry density; S = Saturation; σ_c = Isotropic confining stress; $\dot{\epsilon}$ = Vertical displacement rate; ϵ_a = Axial strain; σ_1 = Major principal stress; σ_3 = Minor principal stress; and G_s = Specific gravity.

Checked By: TSI Date: 07/28/23

APPENDIX VIII

Hydraulic Conductivity Test Report Information and Photographs

ARDAMAN & ASSOCIATES, INC. GEOTECHNICAL TESTING LABORATORY
HYDRAULIC CONDUCTIVITY TEST REPORT

Boring	Sample	Depth (feet)	Visual Description	Specific Gravity [assumed]	Specimen Orientation	Initial Length (cm)	Initial Diameter (cm)	Initial Volume (cm ³)	Mass of Dry Solids (grams)	Initial Water Content (%)	Initial Dry Density (lb/ft ³)	Initial Saturation (%)	Final Volume (cm ³)	Volume Change (%)	Final Water Content (%)	Final Dry Density (lb/ft ³)	Final Saturation (%)	Isotropic Effective Confining Stress (lb/in ²)	Back-pressure (lb/in ²)	Average Hydraulic Gradient	Flow (cm ³)	Outflow/Inflow Ratio	Test Duration (days)	B-factor at End of Test (%)	ASTM D5084 Test Method	Fines Content -200 (%)	Hydraulic Conductivity k ₅₀ (cm/sec)
B-02A	S-1	48.0 - 50.0	Gray clayey sand with shell fragments	2.70	V	10.181	7.258	421.22	567.78	36.7	84.2	99	417.60	-0.9	36.6	84.8	100	5	185	23.3	5.76	1.17	1	100	A	35.3	5.1E-06
B-02A	S-2	56.0 - 58.0	Green gray clay with sand and trace shell fragments	2.70	V	10.182	7.277	423.47	330.17	90.0	48.7	99	425.49	0.5	90.7	48.4	100	5	185	17.3	1.20	0.87	1	100	A	87.5	1.4E-07
B-02A	S-3	61.0 - 63.0	Gray silty sand with trace shell fragments	2.68	V	10.089	7.178	408.27	614.57	29.9	94.0	100	393.11	-3.7	27.4	97.6	100	5	185	17.6	1.02	0.99	1	99	A	20.2	1.1E-05
B-05	S-29	58.0 - 60.0	Gray clayey sand	2.70	V	10.148	7.230	416.63	524.90	41.1	78.6	97	406.75	-2.4	40.5	80.5	100	5	185	14.9	1.39	1.07	1	99	A	28.1	2.6E-05

COMMENTS:
(1) Deaired tap water permeant.

The test data and all associated project information presented hereon shall be held in confidence and disclosed to other parties only with the authorization of the Client. Test samples are kept in storage for at least 10 working days after mailing of the test report, prior to being discarded, unless a longer storage period is requested in writing and accepted by Ardaman & Associates, Inc.

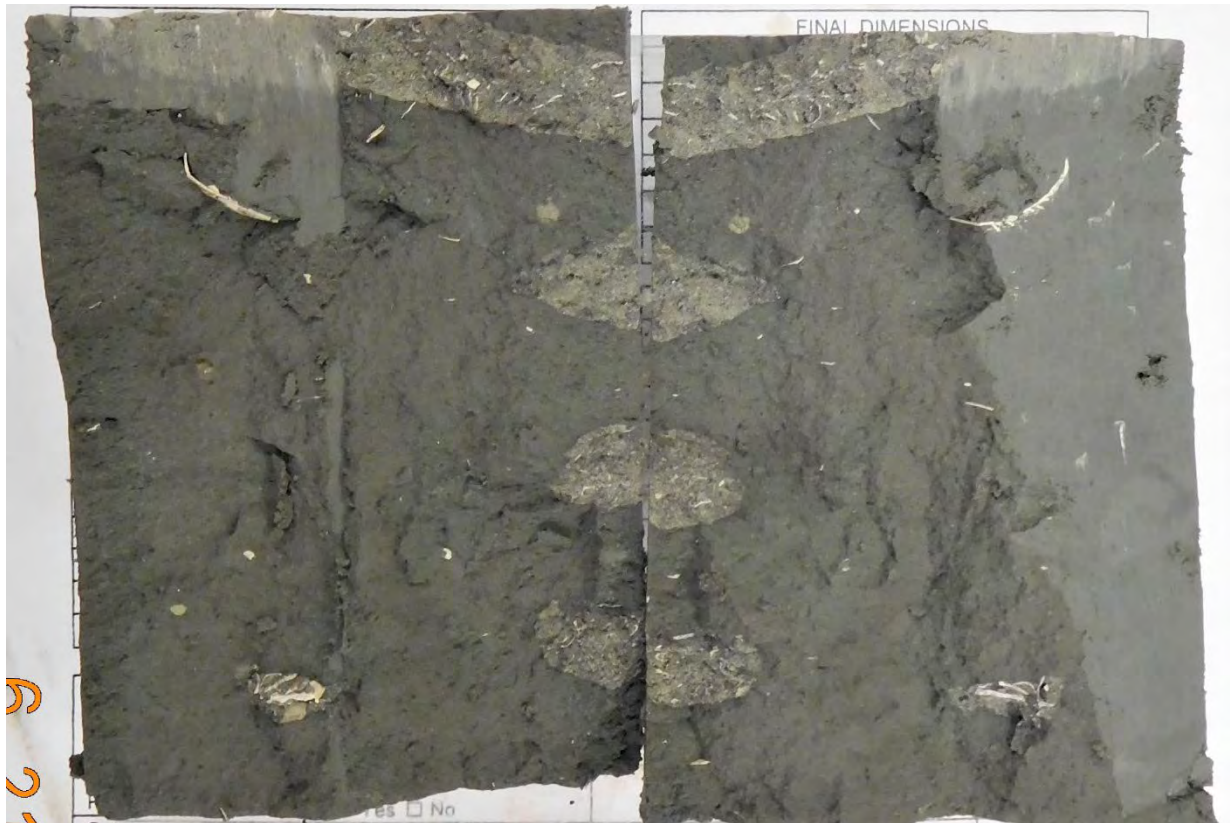
ASTM D5084 Test Methods: Method A - Constant Head; Method C - Falling Head; Rising Tailwater; Method D - Constant Rate of Flow

Where: V denotes vertical test specimen; H denotes horizontal test specimen.

Checked By: TSI Date: 07/24/23



PERMEABILITY TEST SPECIMEN PHOTOGRAPH
BOREHOLE B-02A: SAMPLE 1 DEPTH: 48.0' – 50.0'



PERMEABILITY TEST SPECIMEN PHOTOGRAPH
BOREHOLE B-02A: SAMPLE 2 DEPTH: 56.0' – 58.0'



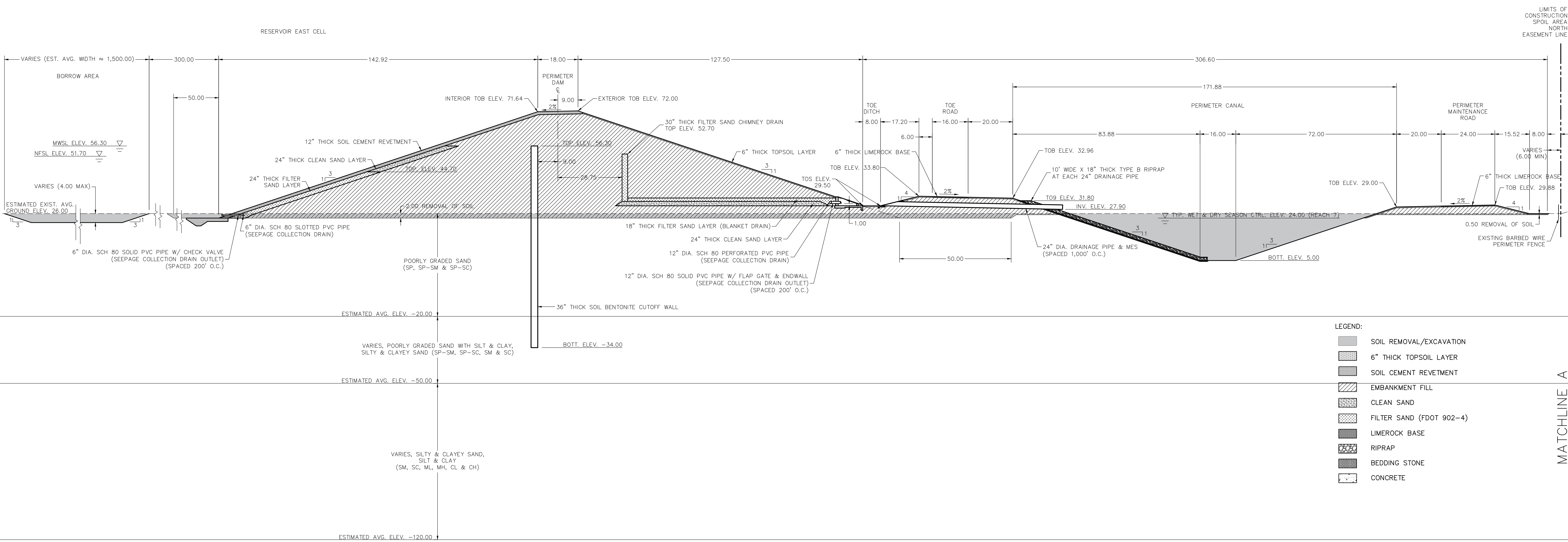
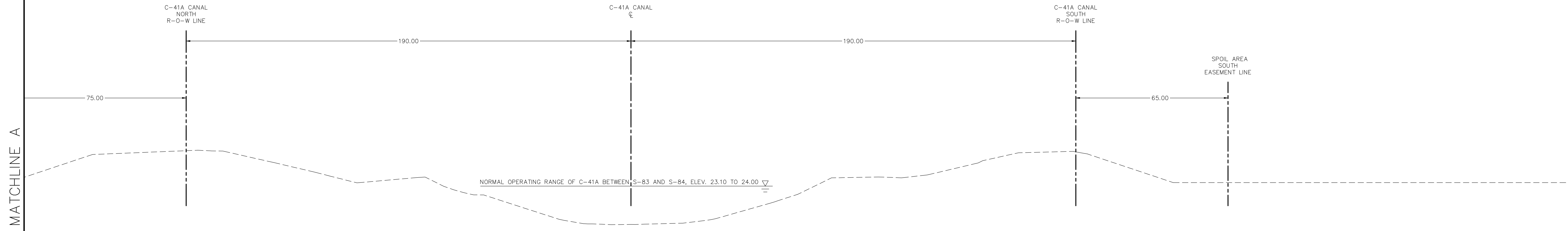
**PERMEABILITY TEST SPECIMEN PHOTOGRAPH
BOREHOLE B-02A: SAMPLE 3 DEPTH: 61.0' – 63.0'**



**PERMEABILITY TEST SPECIMEN PHOTOGRAPH
BOREHOLE B-05: SAMPLE 29 DEPTH: 58.0' – 60.0'**

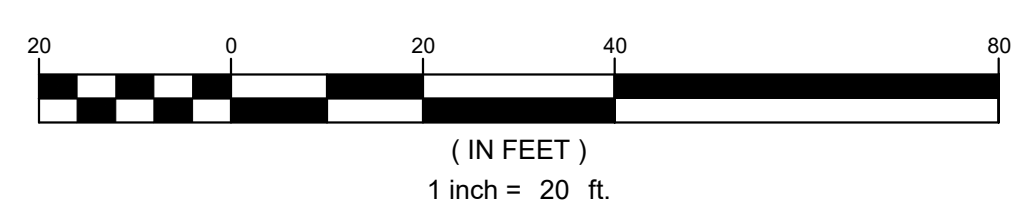
ANNEX B-2
LOCAR Geotechnical Analysis Figures

FIGURE A.8-2.B



- LEGEND:
- SOIL REMOVAL/EXCAVATION
 - 6" THICK TOPSOIL LAYER
 - SOIL CEMENT REVETMENT
 - EMBANKMENT FILL
 - CLEAN SAND
 - FILTER SAND (FDOT 902-4)
 - LIMEROCK BASE
 - RIPRAP
 - BEDDING STONE
 - CONCRETE

LOCAR RECOMMENDED PLAN
SECTION B - RESERVOIR PERIMETER DAM

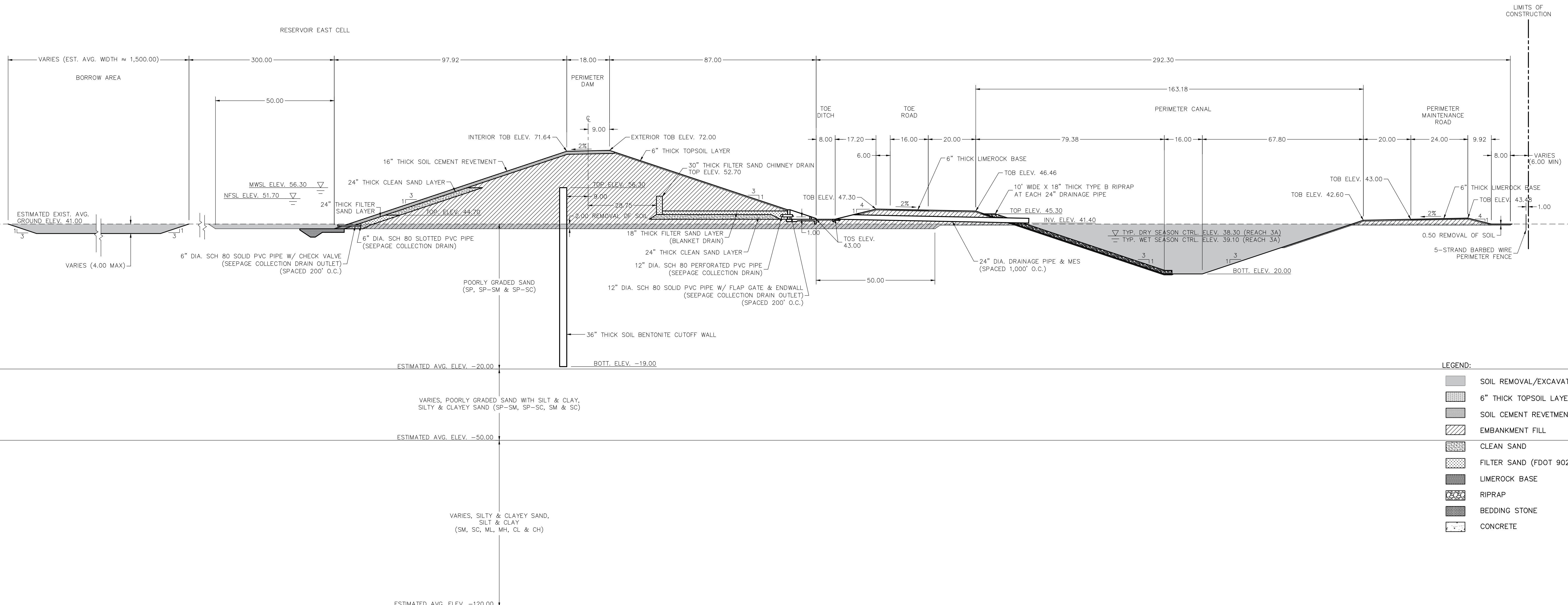


LAKE OKEECHOBEE COMPONENT A RESERVOIR (LOCAR)

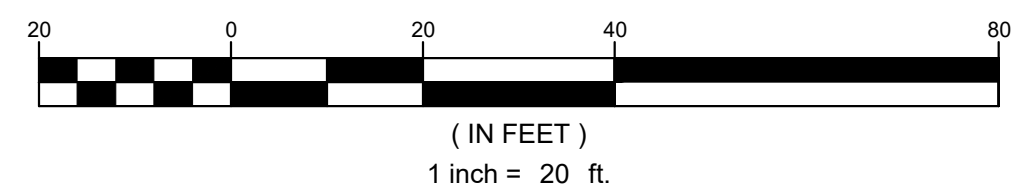
NOTE:
1. ELEVATIONS SHOWN HEREON ARE EXPRESSED IN FEET AND ARE BASED ON THE NORTH AMERICAN VERTICAL DATUM OF 1988 (NAVD88). NGVD29 = NAVD88 + 1.2 FEET FOR THE LOCAR PROJECT LIMITS OF CONSTRUCTION.

DRAWING PREPARED BY J-TECH
TYPICAL SECTION SHEET LAYOUTS.DWG
11/30/2023

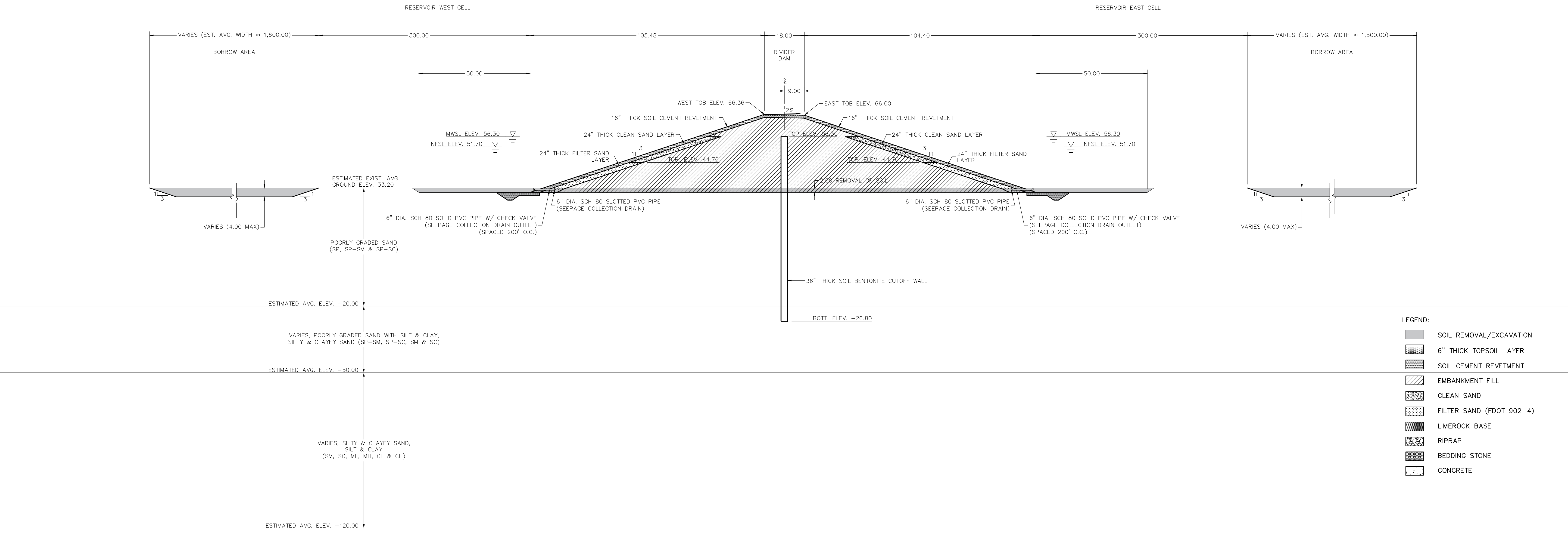
FIGURE A.8-2.C



LOCAR RECOMMENDED PLAN
SECTION C - RESERVOIR PERIMETER DAM

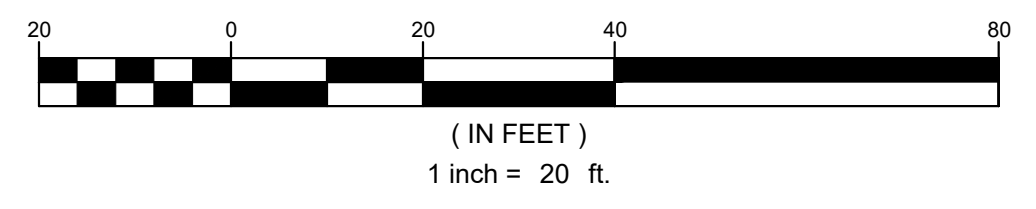


NOTE:
 1. ELEVATIONS SHOWN HEREON ARE EXPRESSED IN FEET AND ARE BASED ON THE NORTH AMERICAN VERTICAL DATUM OF 1988 (NAVD88). NGVD29 = NAVD88 + 1.2 FEET FOR THE LOCAR PROJECT LIMITS OF CONSTRUCTION.



- LEGEND:
- SOIL REMOVAL/EXCAVATION
 - 6" THICK TOPSOIL LAYER
 - SOIL CEMENT REVETMENT
 - EMBANKMENT FILL
 - CLEAN SAND
 - FILTER SAND (FDOT 902-4)
 - LIMEROCK BASE
 - RIPRAP
 - BEDDING STONE
 - CONCRETE

LOCAR RECOMMENDED PLAN
SECTION D - RESERVOIR DIVIDER DAM



LAKE OKEECHOBEE COMPONENT A RESERVOIR (LOCAR)

NOTE:
1. ELEVATIONS SHOWN HEREON ARE EXPRESSED IN FEET AND ARE BASED ON THE NORTH AMERICAN VERTICAL DATUM OF 1988 (NAVD88). NGVD29 = NAVD88 + 1.2 FEET FOR THE LOCAR PROJECT LIMITS OF CONSTRUCTION.

Figure A.8.7-1

Color	Name	Material Model	K-Function	Sat Kx (cm/sec)	Ky'/Kx' Ratio
Black	Cutoff Wall	Saturated Only		1e-06	1
Yellow	Embankment FILL	Saturated / Unsaturated	Fill K		0.5
Light Yellow	Sand (SP, SP-SM, SP-SC)- Unit A	Saturated / Unsaturated	SAND K		0.2
Light Gray	Sand Blanket/Chimney Drain	Saturated / Unsaturated	Drain Material K		1
Dark Gray	Sand Filter	Saturated / Unsaturated	Sand Filter K		1
Light Green	Sand with Silt (SP-SM)- Unit C	Saturated / Unsaturated	Sand with Silt K		0.2
Orange	SC, SM, ML, MH, CL, CH, Miscellaneous- Unit D	Saturated / Unsaturated	Silty/Clayey, Misc Silts and Clay K		0.1

Color	Name	Category	Kind	Parameters
Purple	Normal Pool (51.7')	Hydraulic	Water Total Head	51.7 ft
Blue	Seepage Canal- 30.2'	Hydraulic	Water Total Head	30.2 ft

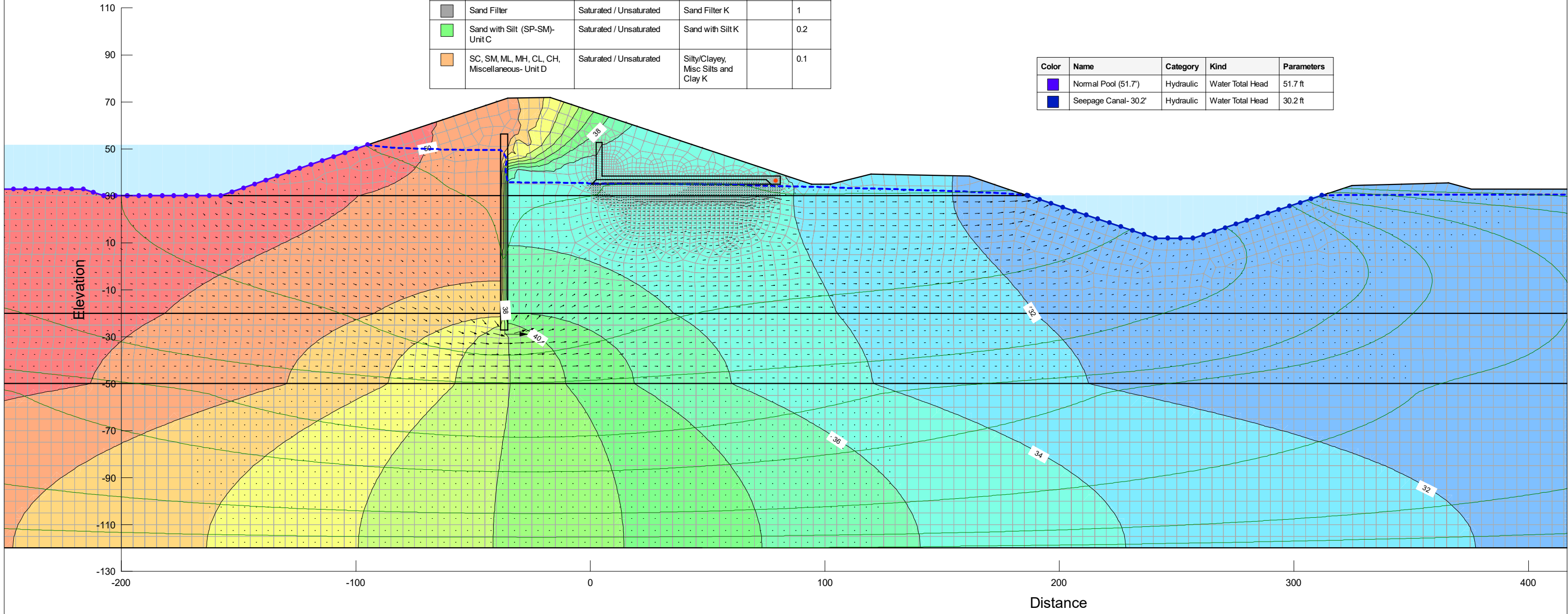


Figure A.8.7-2

Color	Name	Material Model	K-Function	Sat Kx (cm/sec)	Ky'/Kx' Ratio
Black	Cutoff Wall	Saturated Only		1e-06	1
Yellow	Embankment FILL	Saturated / Unsaturated	Fill K		0.5
Light Yellow	Sand (SP, SP-SM, SP-SC)- Unit A	Saturated / Unsaturated	SAND K		0.2
Light Gray	Sand Blanket/Chimney Drain	Saturated / Unsaturated	Drain Material K		1
Dark Gray	Sand Filter	Saturated / Unsaturated	Sand Filter K		1
Light Green	Sand with Silt (SP-SM)- Unit C	Saturated / Unsaturated	Sand with Silt K		0.2
Orange	SC, SM, ML, MH, CL, CH, Miscellaneous- Unit D	Saturated / Unsaturated	Silty/Clayey, Misc Silts and Clay K		0.1

Color	Name	Category	Kind	Parameters
Purple	PMF/PMP (56.3')	Hydraulic	Water Total Head	56.3 ft
Blue	Seepage Canal- 31'	Hydraulic	Water Total Head	31 ft

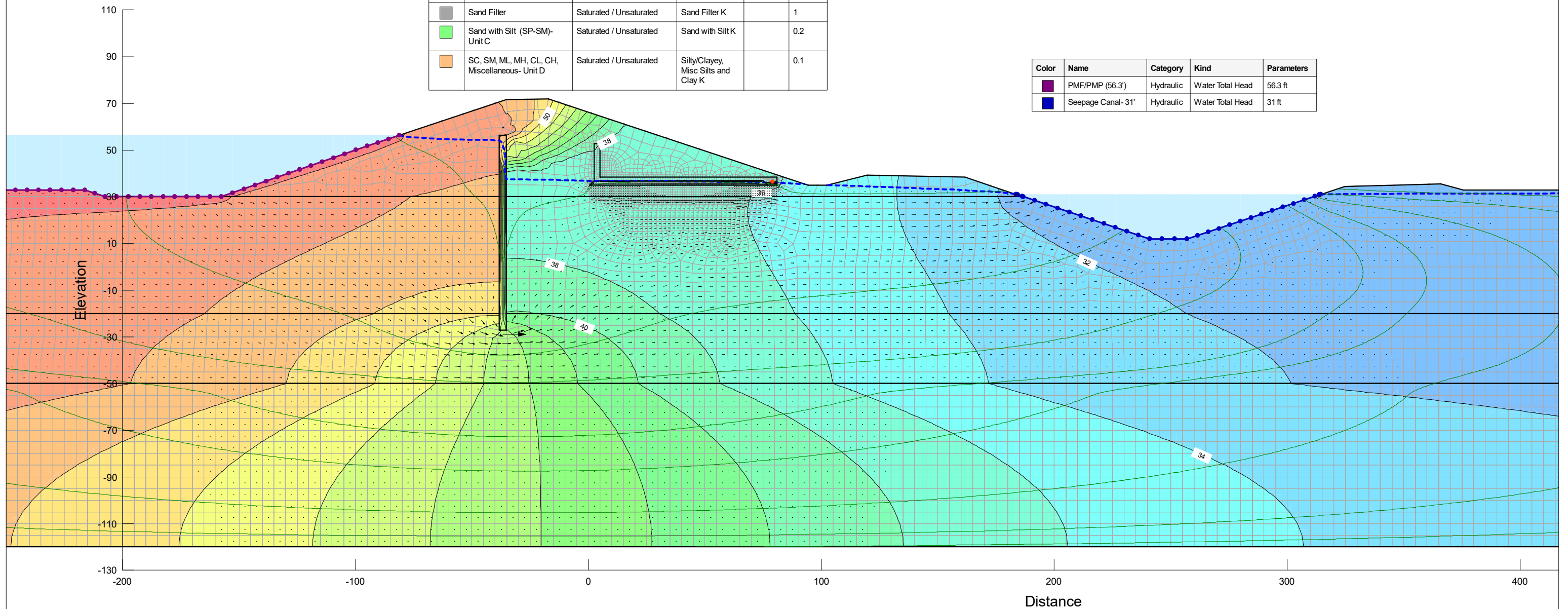


Figure A.8.7-3

LOCAR- Recommended Plan
Typical Section B - Normal Pool

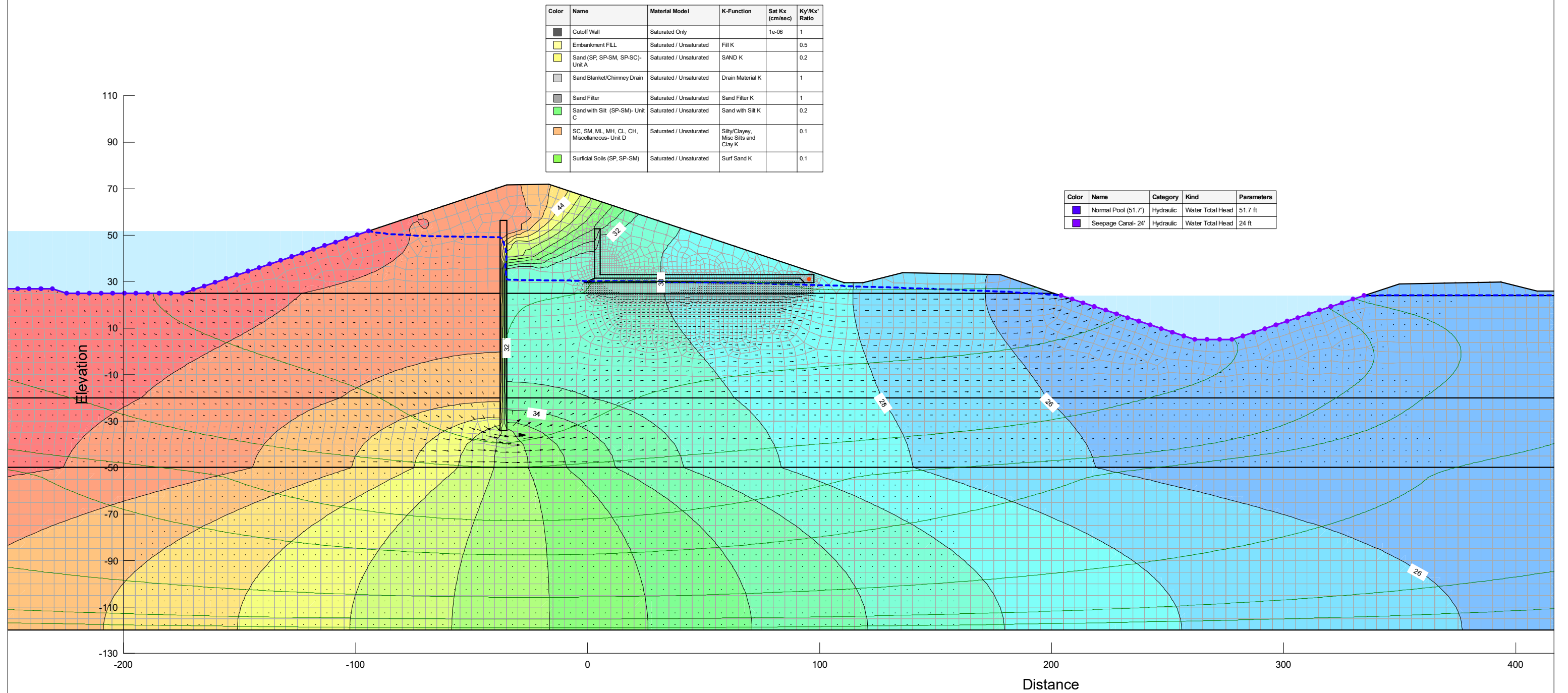


Figure A.8.7-3.A

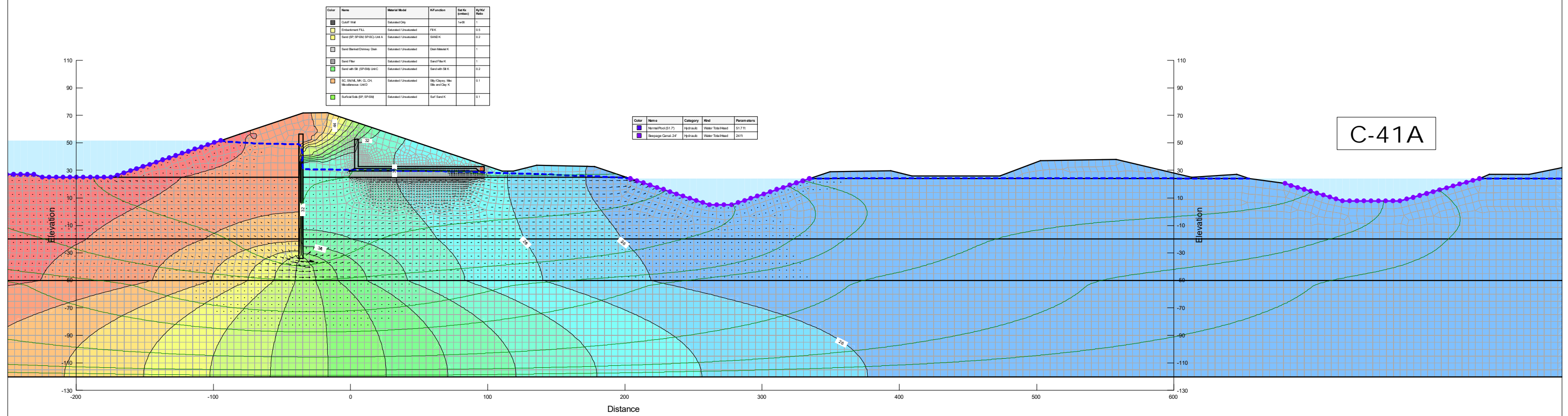


Figure A.8.7-4

LOCAR- Recommended Plan
Typical Section B - PMF/PMP

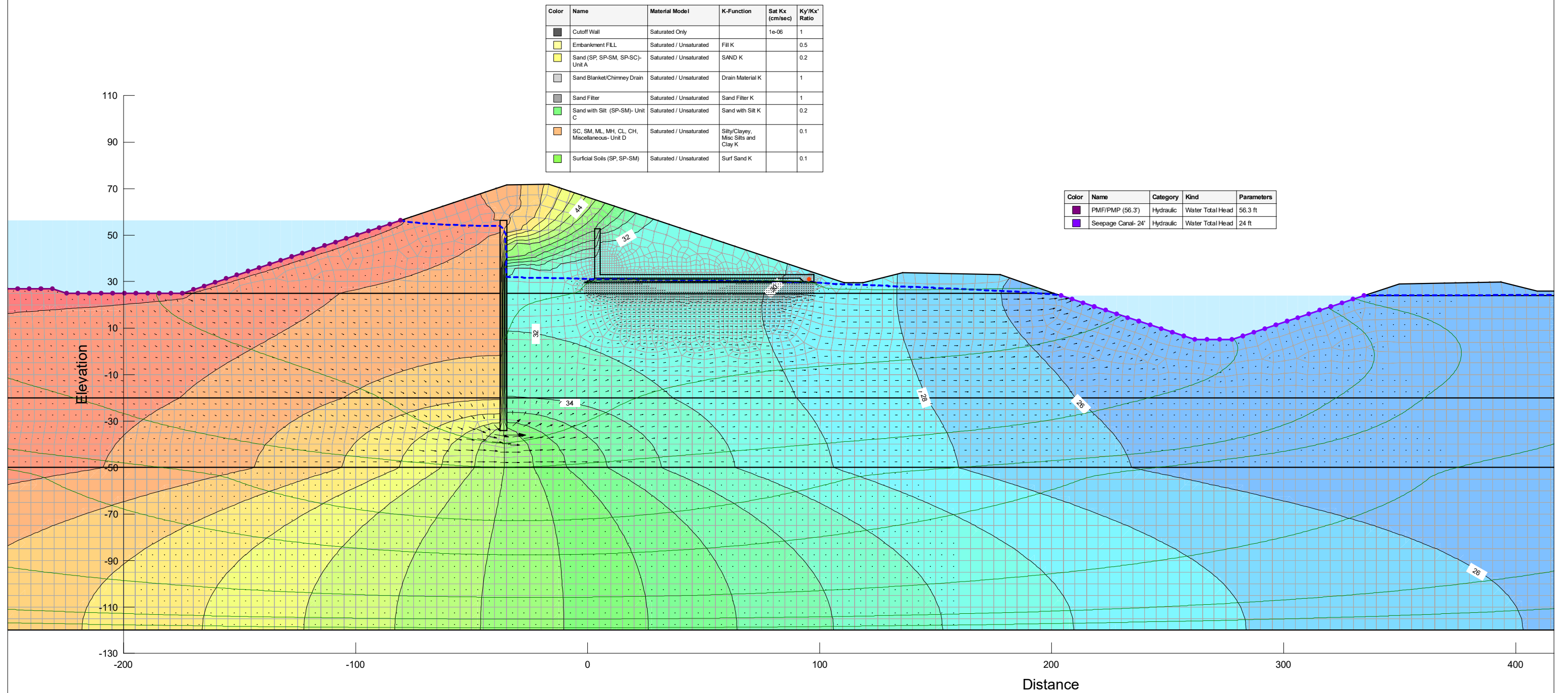


Figure A.8.7-5

LOCAR- Recommended Plan
Typical Section C - Normal Pool

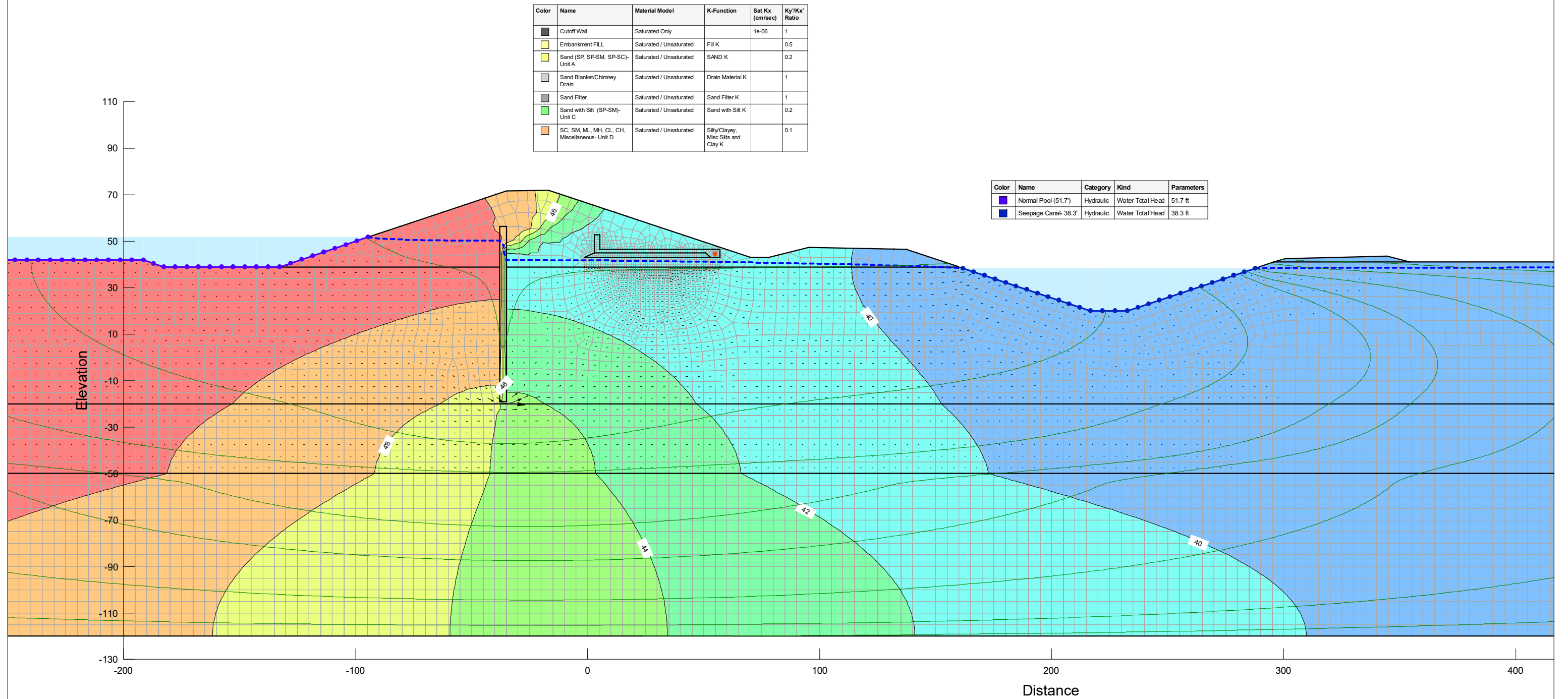


Figure A.8.7-6

LOCAR- Recommended Plan
Typical Section C - PMF/PMP

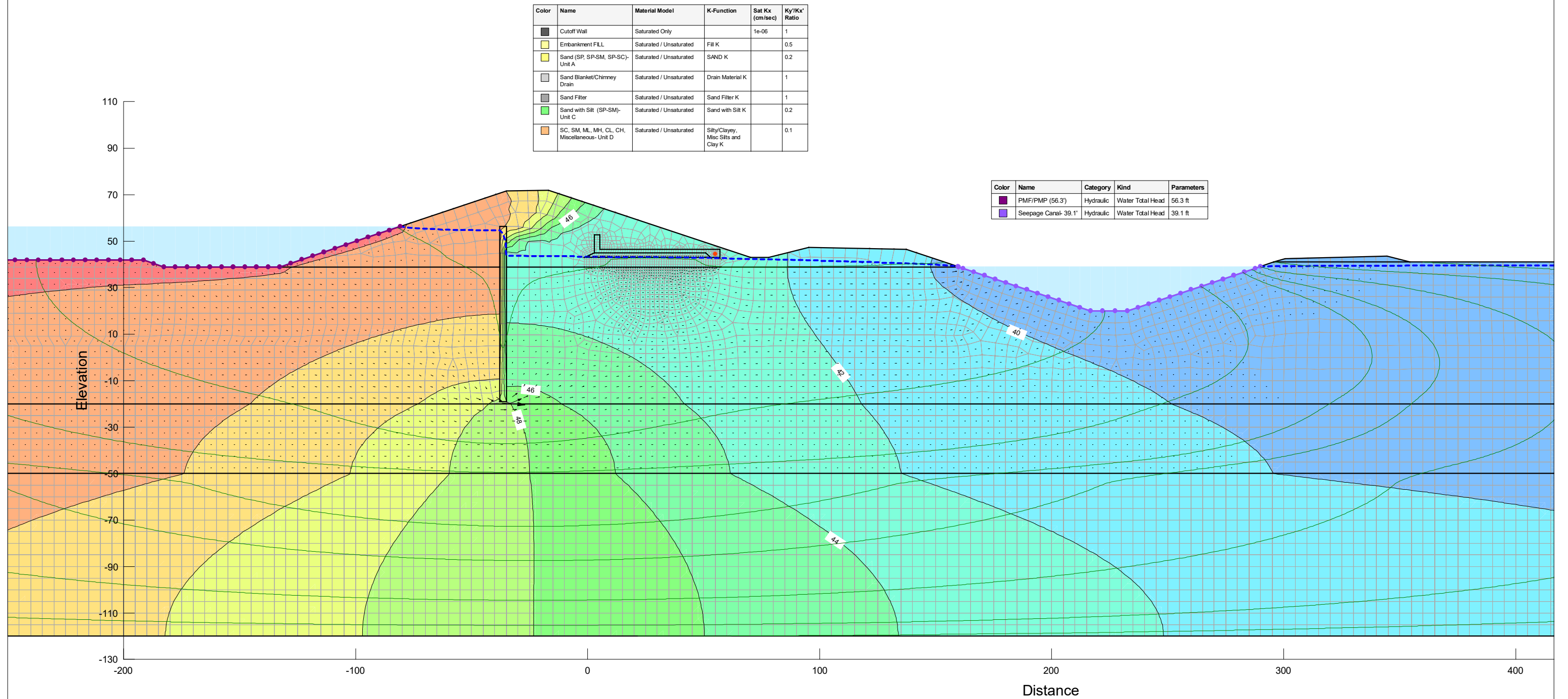


Figure A.8.7-7

LOCAR- Recommended Plan
Typical Section D - Normal Pool

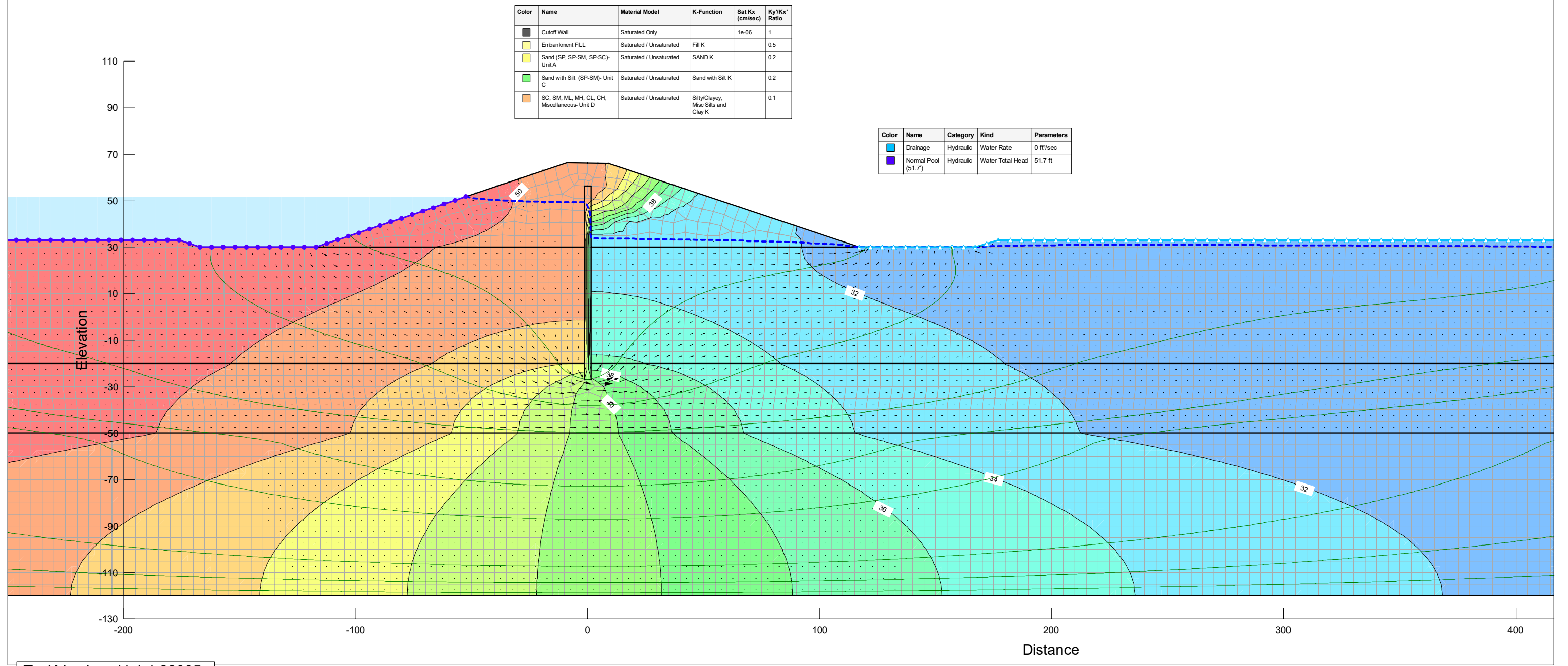


Figure A.8.7-8

LOCAR- Recommended Plan
Typical Section D - PMF/PMP

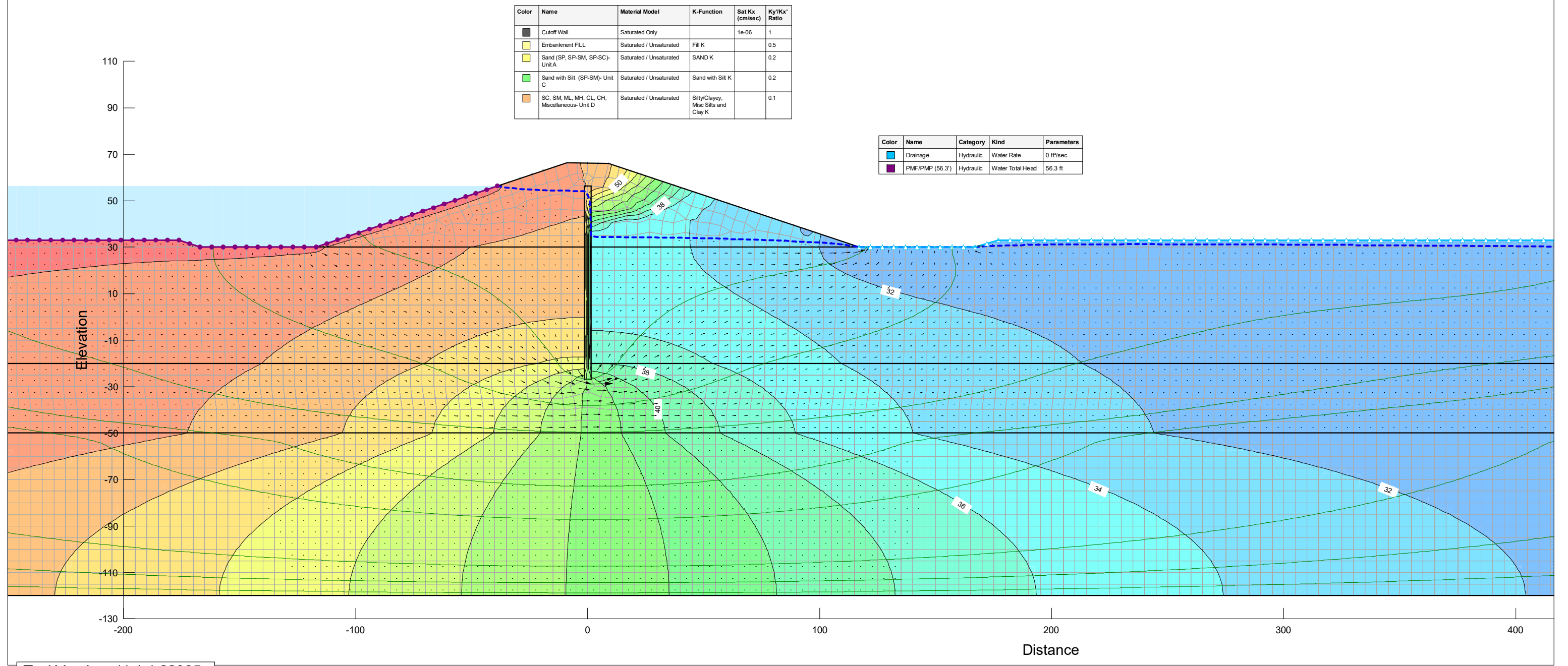


Figure A.8.7-9

LOCAR- Recommended Plan
Typical Section A - Normal Pool
Rapid Drawdown

Color	Name	Material Model	K-Function	Sat Kx (cm/sec)	Ky'/Kx' Ratio
Black	Cutoff Wall	Saturated Only		1e-06	1
Yellow	Embankment FILL	Saturated / Unsaturated	Fill K		0.5
Light Yellow	Sand (SP, SP-SM, SP-SC)- Unit A	Saturated / Unsaturated	SAND K		0.2
Light Gray	Sand Blanket/Chimney Drain	Saturated / Unsaturated	Drain Material K		1
Dark Gray	Sand Filter	Saturated / Unsaturated	Sand Filter K		1
Light Green	Sand with Silt (SP-SM)- Unit C	Saturated / Unsaturated	Sand with Silt K		0.2
Orange	SC, SM, ML, MH, CL, CH, Miscellaneous- Unit D	Saturated / Unsaturated	Silty/Clayey, Misc Silts and Clay K		0.1

Color	Name	Category	Kind	Parameters
Yellow	Drawdown	Hydraulic	Water Pressure Head	0 ft
Blue	Seepage Canal- 30.2'	Hydraulic	Water Total Head	30.2 ft

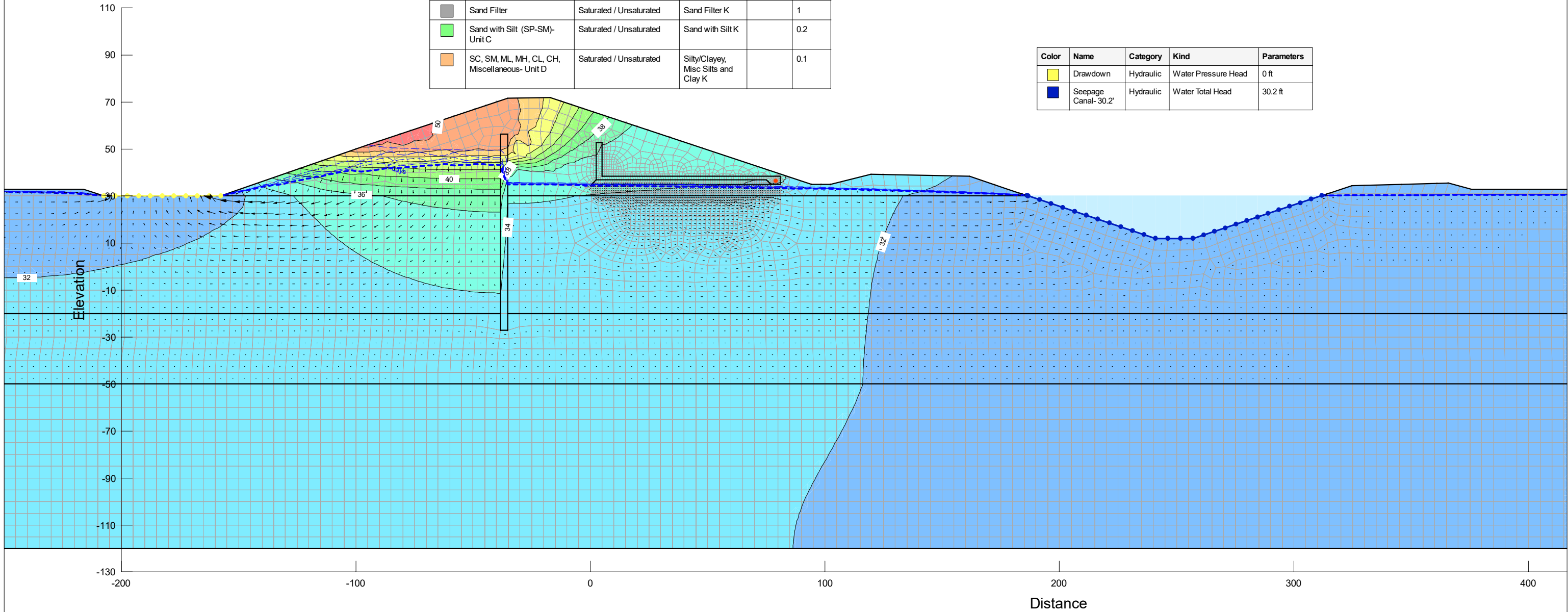


Figure A.8.7-10

LOCAR- Recommended Plan
Typical Section A - PMF/ PMP
Rapid Drawdown

Color	Name	Material Model	K-Function	Sat Kx (cm/sec)	Ky'/Kx' Ratio
Black	Cutoff Wall	Saturated Only		1e-06	1
Yellow	Embankment FILL	Saturated / Unsaturated	Fill K		0.5
Light Yellow	Sand (SP, SP-SM, SP-SC)- Unit A	Saturated / Unsaturated	SAND K		0.2
Light Gray	Sand Blanket/Chimney Drain	Saturated / Unsaturated	Drain Material K		1
Dark Gray	Sand Filter	Saturated / Unsaturated	Sand Filter K		1
Light Green	Sand with Silt (SP-SM)- Unit C	Saturated / Unsaturated	Sand with Silt K		0.2
Orange	SC, SM, ML, MH, CL, CH, Miscellaneous- Unit D	Saturated / Unsaturated	Silty/Clayey, Misc Silts and Clay K		0.1

Color	Name	Category	Kind	Parameters
Yellow	Drawdown	Hydraulic	Water Pressure Head	0 ft
Blue	Seepage Canal- 31'	Hydraulic	Water Total Head	31 ft

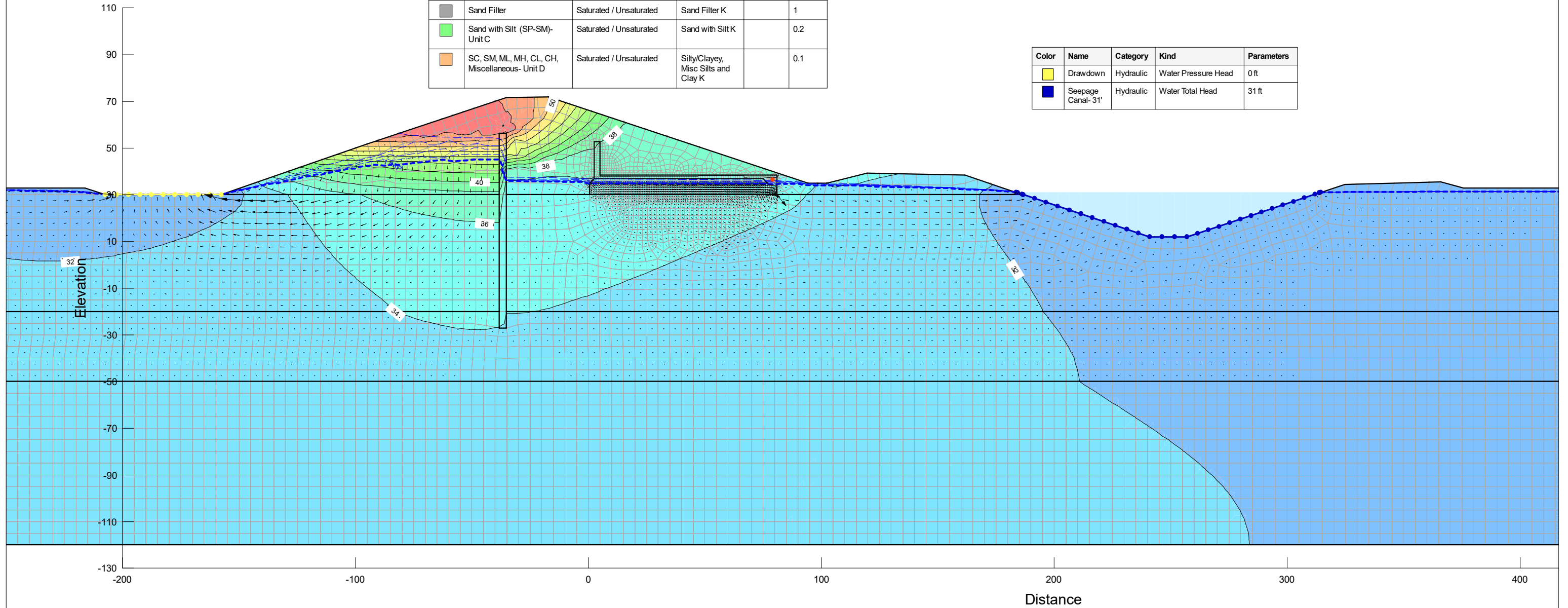


Figure A.8.7-11

LOCAR- Recommended Plan
 Typical Section B - Normal Pool
 Rapid Drawdown

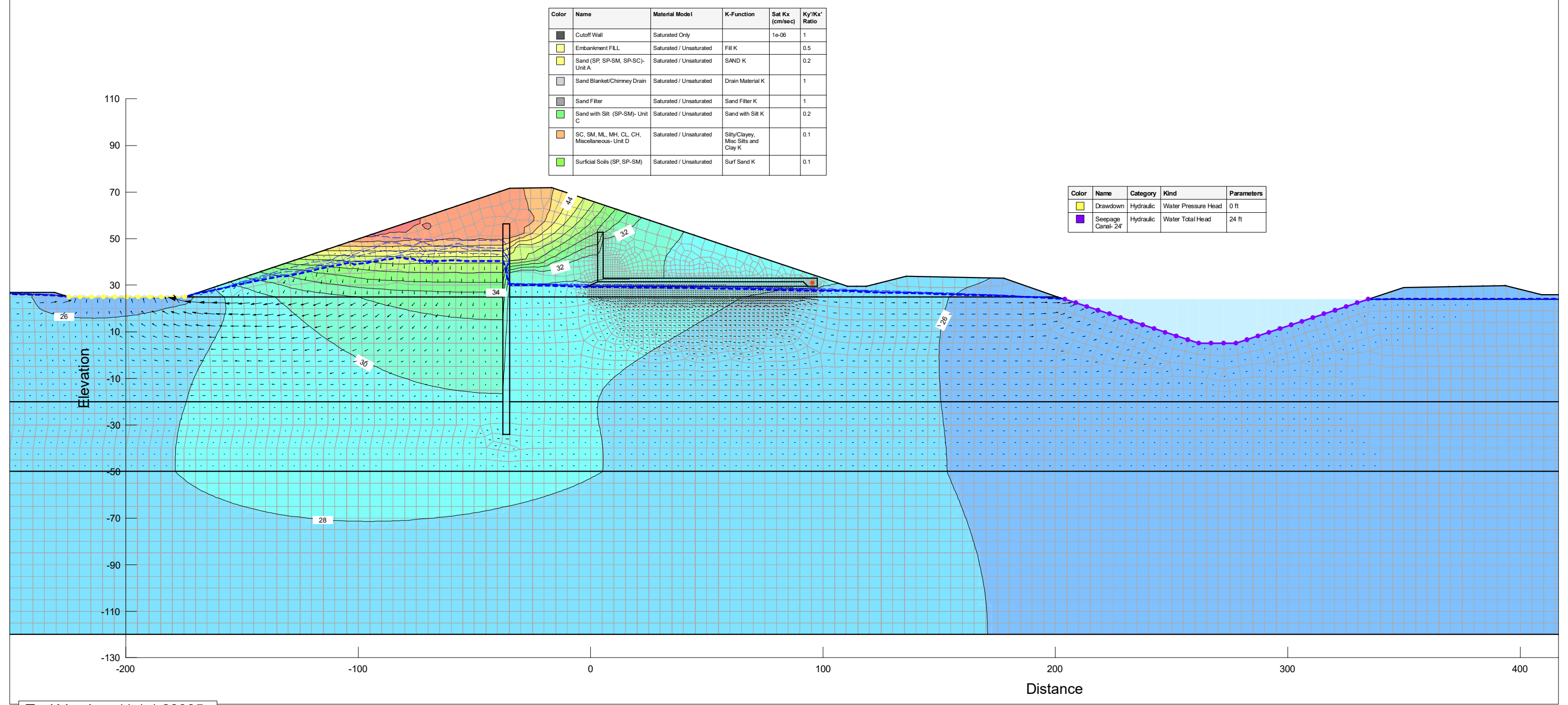


Figure A.8.7-12

LOCAR- Recommended Plan
Typical Section B - PMF/PMP
Rapid Drawdown

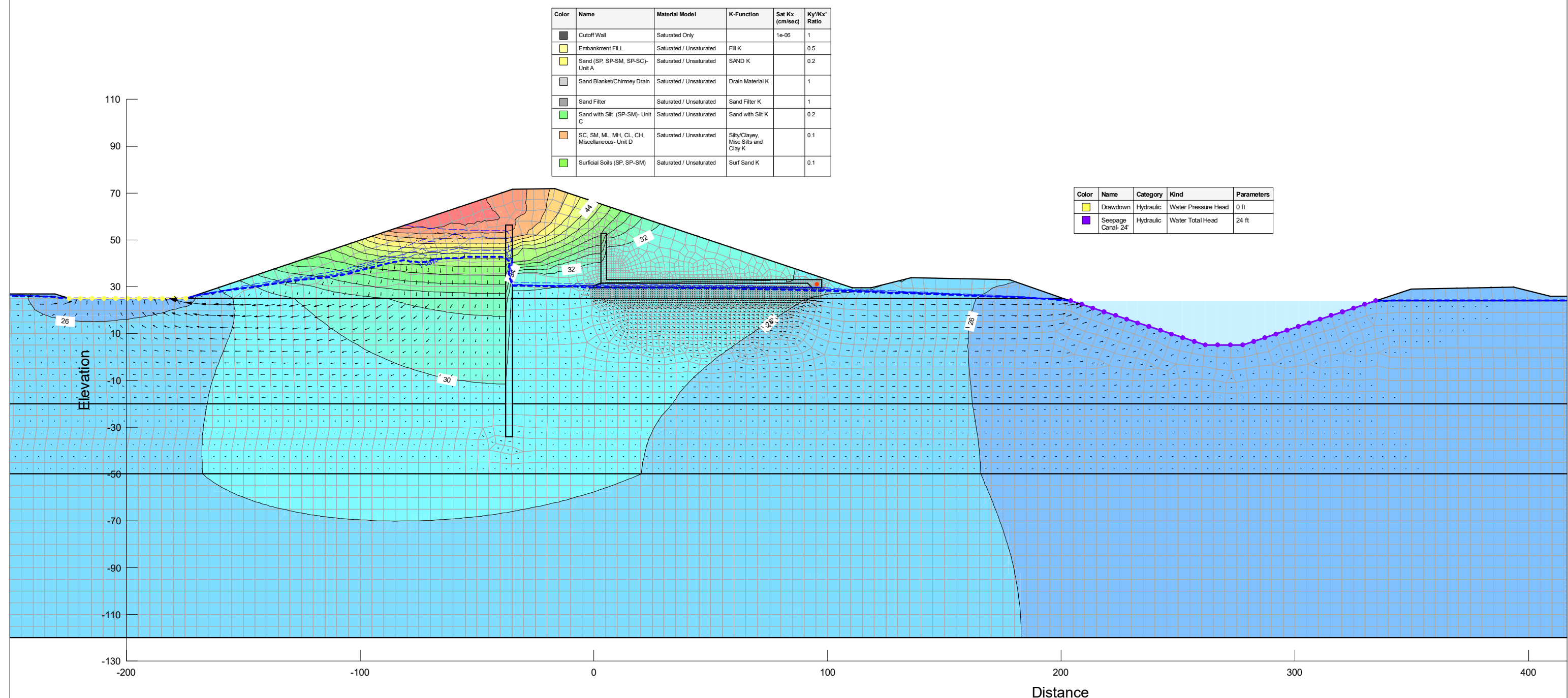


Figure A.8.7-13

LOCAR- Recommended Plan
Typical Section C - Normal Pool
Rapid Drawdown

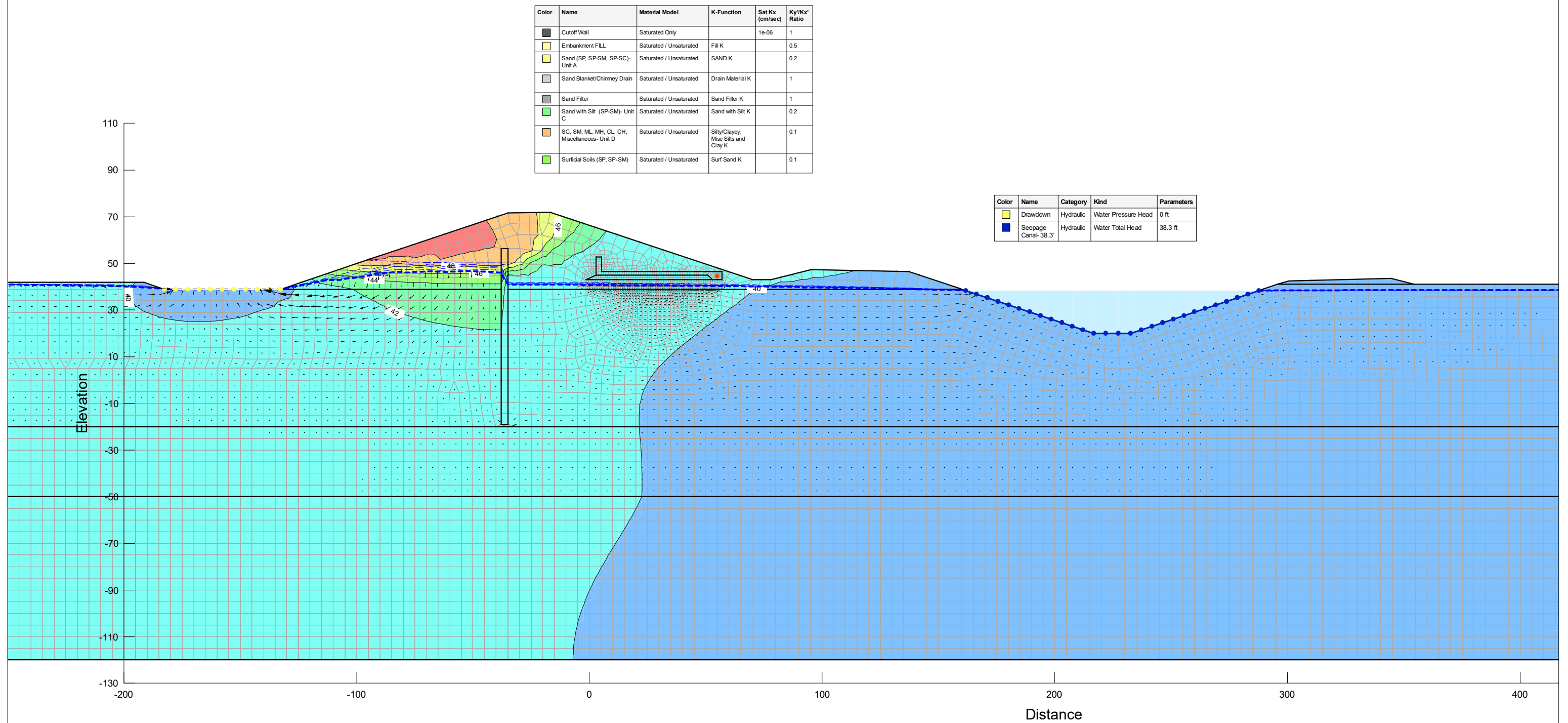


Figure A.8.7-14

LOCAR- Recommended Plan
Typical Section C - PMF/PMP
Rapid Drawdown

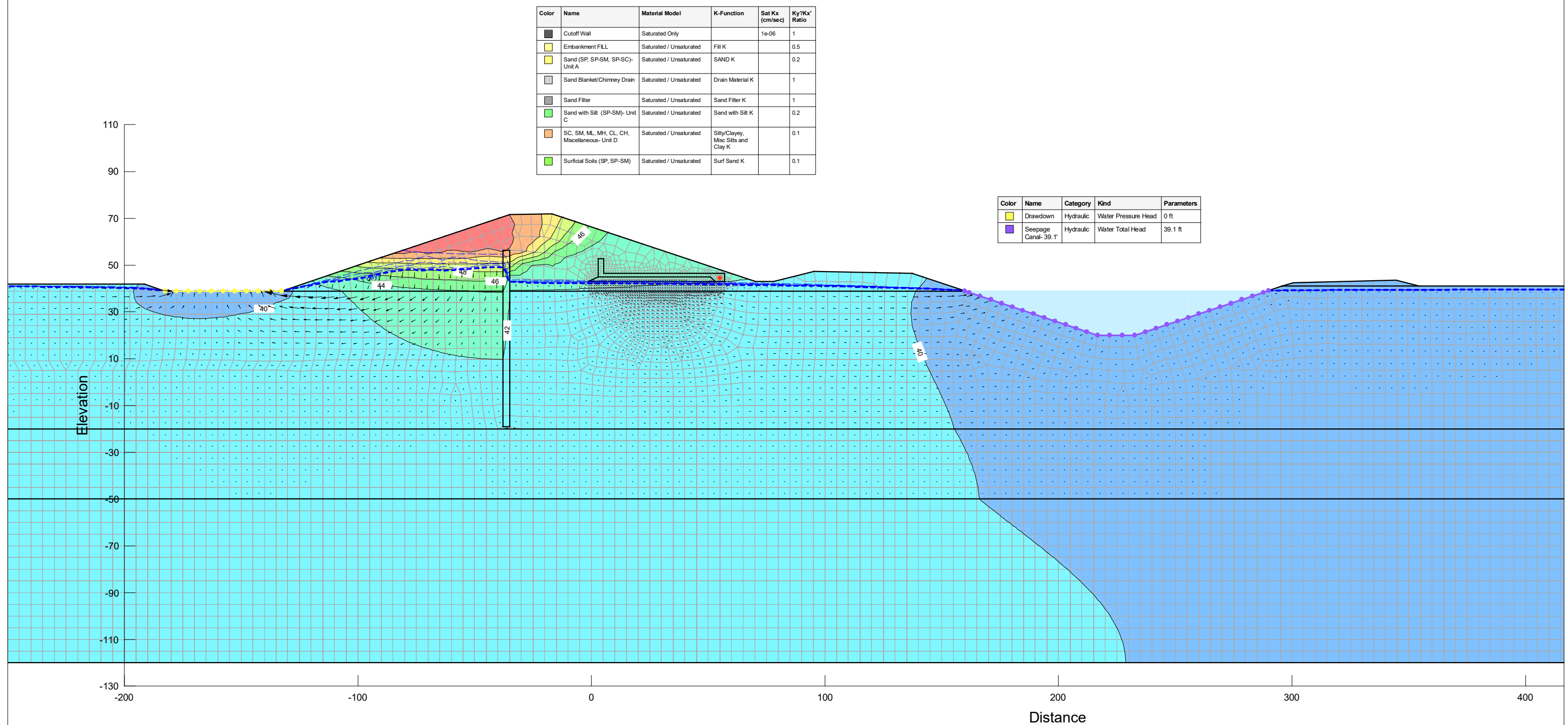


Figure A.8.7-15

LOCAR- Recommended Plan
 Typical Section D - Normal Pool
 Rapid Drawdown

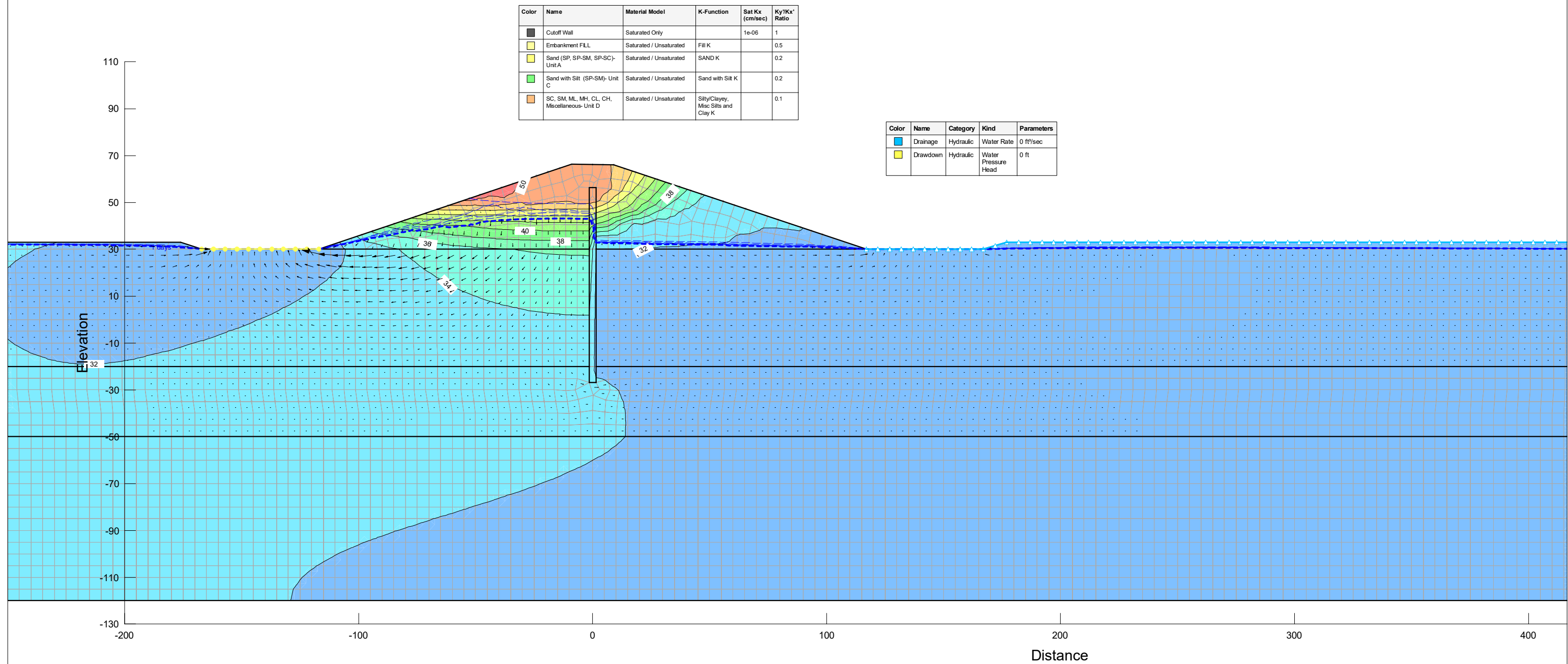


Figure A.8.7-16

LOCAR- Recommended Plan
Typical Section D - PMF/PMP
Rapid Drawdown

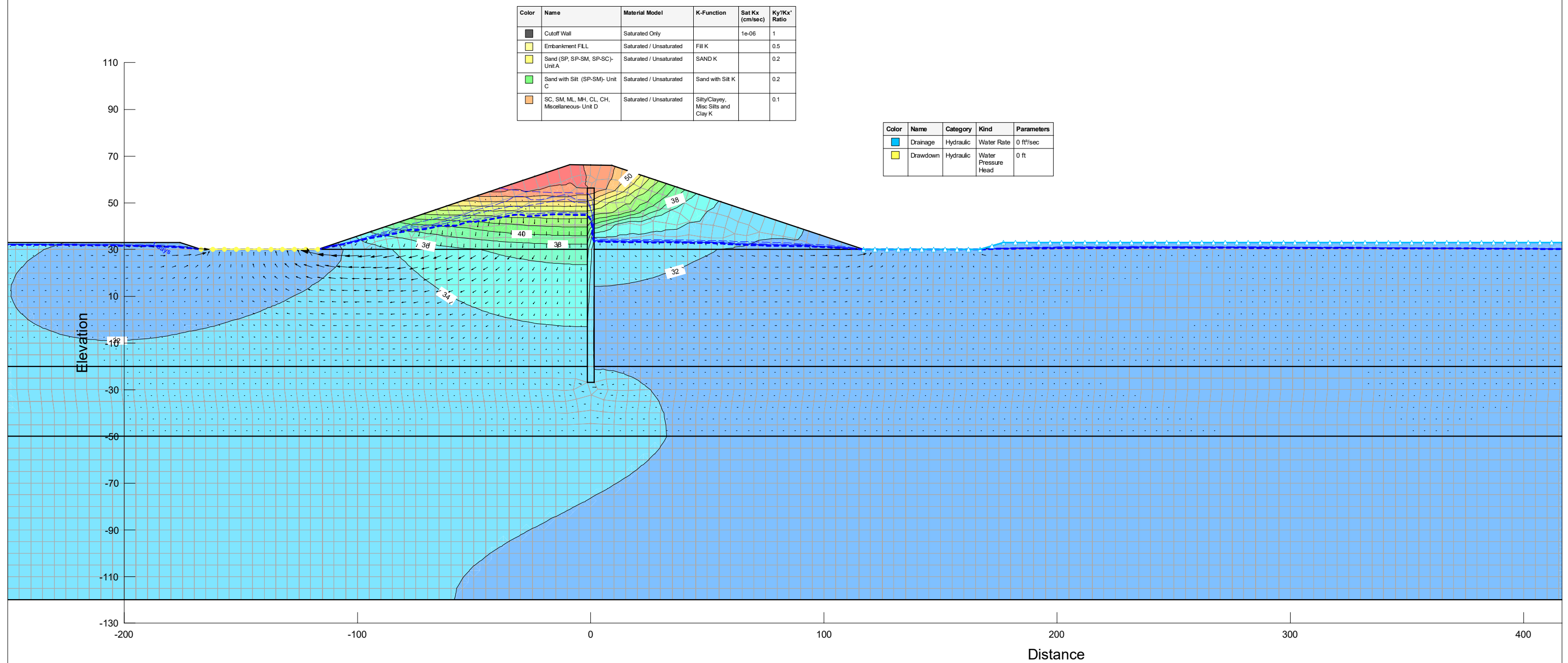


Figure A.8.8-1

LOCAR- Recommended Plan
 Typical Section A - Normal Pool
 Steady-State Downstream Slope
 Circular Failure/ Spencer

Color	Name	Material Model	Unit Weight (pcf)	Effective Cohesion (psf)	Effective Friction Angle (°)	Phi-B (°)
Black	Cutoff Wall	Mohr-Coulomb	90	50	26	0
Yellow	Embankment FILL	Mohr-Coulomb	115	0	34	0
Light Yellow	Sand (SP, SP-SM, SP-SC)- Unit A	Mohr-Coulomb	110	0	32	0
Light Gray	Sand Blanket/Chimney Drain	Mohr-Coulomb	105	0	32	0
Dark Gray	Sand Filter	Mohr-Coulomb	105	0	32	0
Light Green	Sand with Silt (SP-SM)- Unit C	Mohr-Coulomb	115	0	35	0
Orange	SC, SM, ML, MH, CL, CH, Miscellaneous- Unit D	Mohr-Coulomb	120	0	33	0

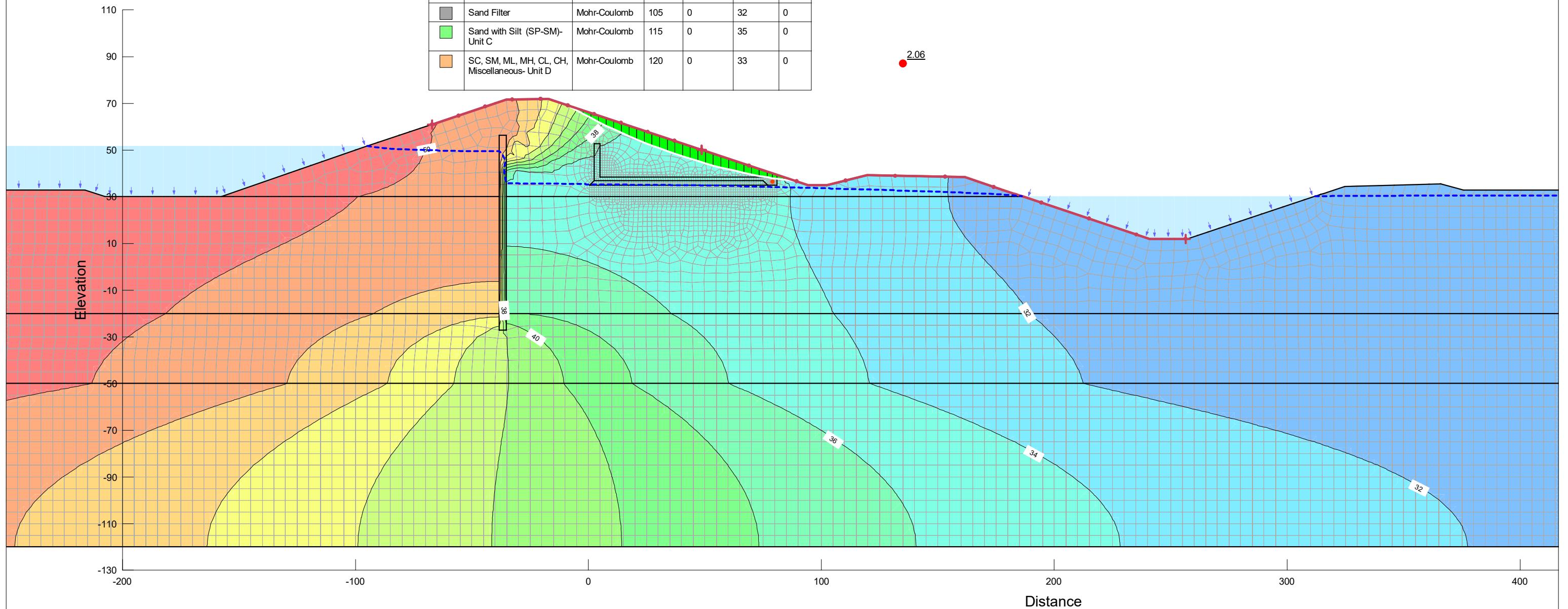


Figure A.8.8-2

LOCAR- Recommended Plan
 Typical Section A - Normal Pool
 Steady-State Upstream Slope
 Circular Failure/ Spencer

Color	Name	Material Model	Unit Weight (pcf)	Effective Cohesion (psf)	Effective Friction Angle (°)	Phi-B (°)
Black	Cutoff Wall	Mohr-Coulomb	90	50	26	0
Yellow	Embankment FILL	Mohr-Coulomb	115	0	34	0
Light Yellow	Sand (SP, SP-SM, SP-SC)- Unit A	Mohr-Coulomb	110	0	32	0
Light Gray	Sand Blanket/Chimney Drain	Mohr-Coulomb	105	0	32	0
Dark Gray	Sand Filter	Mohr-Coulomb	105	0	32	0
Green	Sand with Silt (SP-SM)- Unit C	Mohr-Coulomb	115	0	35	0
Orange	SC, SM, ML, MH, CL, CH, Miscellaneous- Unit D	Mohr-Coulomb	120	0	33	0

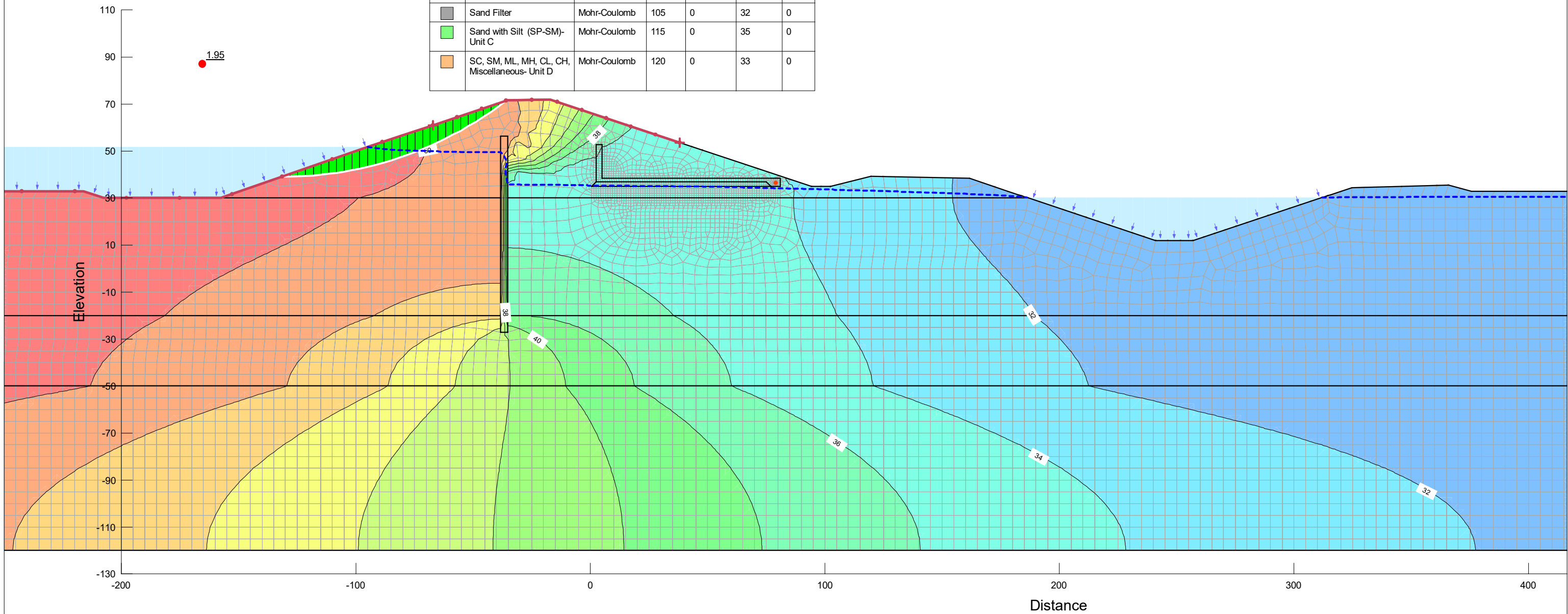


Figure A.8.8-3

LOCAR- Recommended Plan
 Typical Section A - PMF/ PMP
 Steady-State Downstream Slope
 Circular Failure/ Spencer

Color	Name	Material Model	Unit Weight (pcf)	Effective Cohesion (psf)	Effective Friction Angle (°)	Phi-B (°)
Black	Cutoff Wall	Mohr-Coulomb	90	50	26	0
Yellow	Embankment FILL	Mohr-Coulomb	115	0	34	0
Light Yellow	Sand (SP, SP-SM, SP-SC)- Unit A	Mohr-Coulomb	110	0	32	0
Light Gray	Sand Blanket/Chimney Drain	Mohr-Coulomb	105	0	32	0
Dark Gray	Sand Filter	Mohr-Coulomb	105	0	32	0
Green	Sand with Silt (SP-SM)- Unit C	Mohr-Coulomb	115	0	35	0
Orange	SC, SM, ML, MH, CL, CH, Miscellaneous- Unit D	Mohr-Coulomb	120	0	33	0

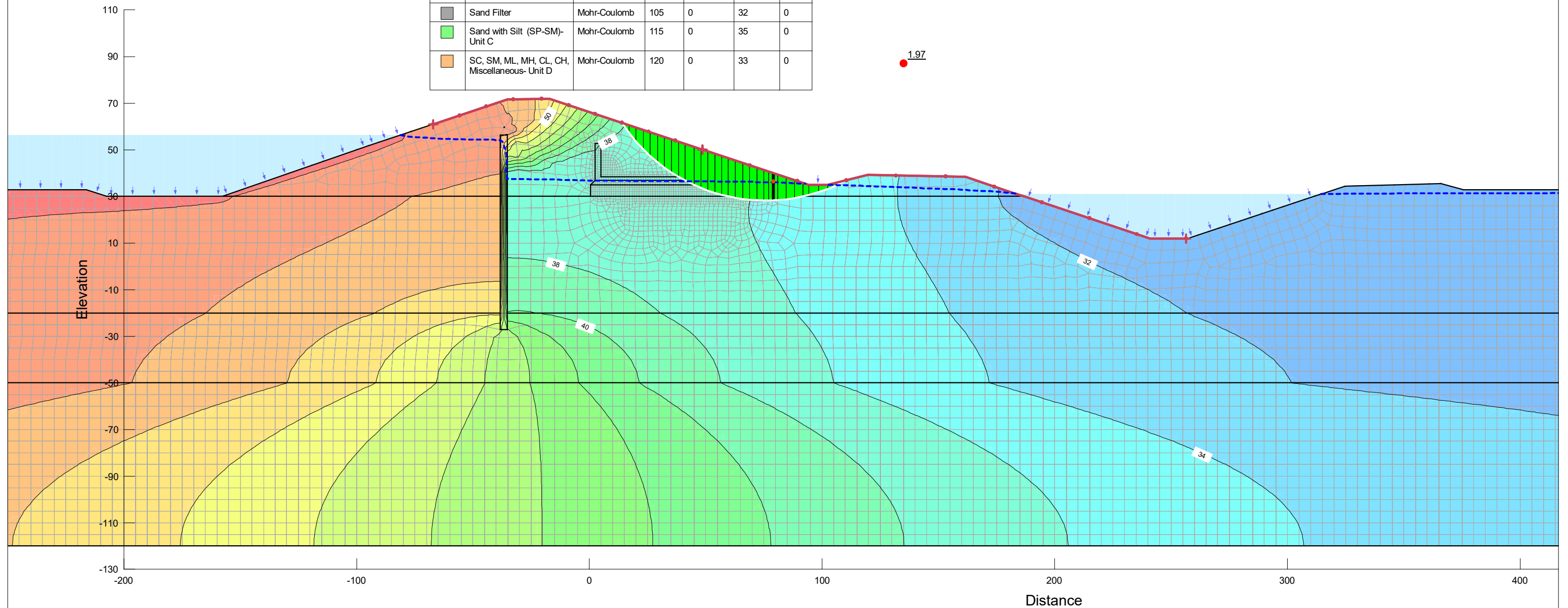


Figure A.8.8-4

LOCAR- Recommended Plan
 Typical Section A - PMF/ PMP
 Steady-State Upstream Slope
 Circular Failure/ Spencer

Color	Name	Material Model	Unit Weight (pcf)	Effective Cohesion (psf)	Effective Friction Angle (°)	Phi-B (°)
Black	Cutoff Wall	Mohr-Coulomb	90	50	26	0
Yellow	Embankment FILL	Mohr-Coulomb	115	0	34	0
Light Yellow	Sand (SP, SP-SM, SP-SC)- Unit A	Mohr-Coulomb	110	0	32	0
Light Gray	Sand Blanket/Chimney Drain	Mohr-Coulomb	105	0	32	0
Dark Gray	Sand Filter	Mohr-Coulomb	105	0	32	0
Green	Sand with Silt (SP-SM)- Unit C	Mohr-Coulomb	115	0	35	0
Orange	SC, SM, ML, MH, CL, CH, Miscellaneous- Unit D	Mohr-Coulomb	120	0	33	0

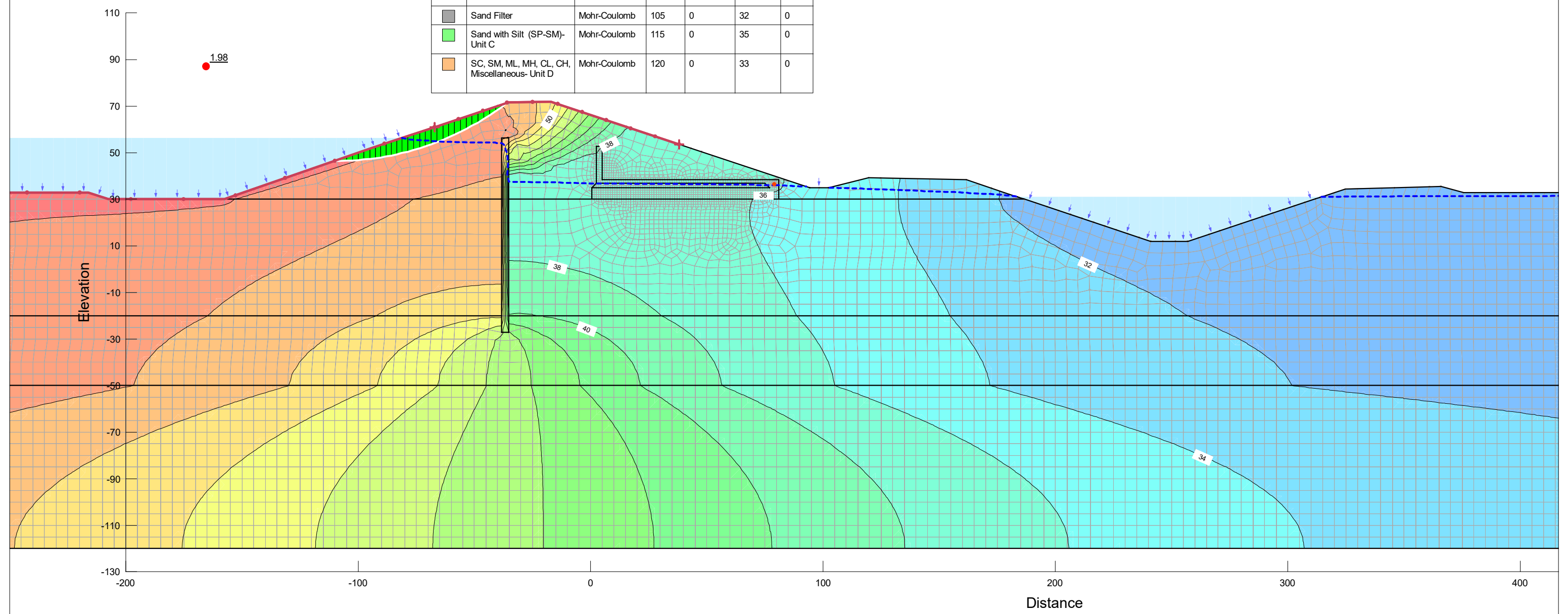


Figure A.8.8-5

LOCAR- Recommended Plan
 Typical Section B - Normal Pool
 Steady-State Downstream Slope
 Circular Failure/ Spencer

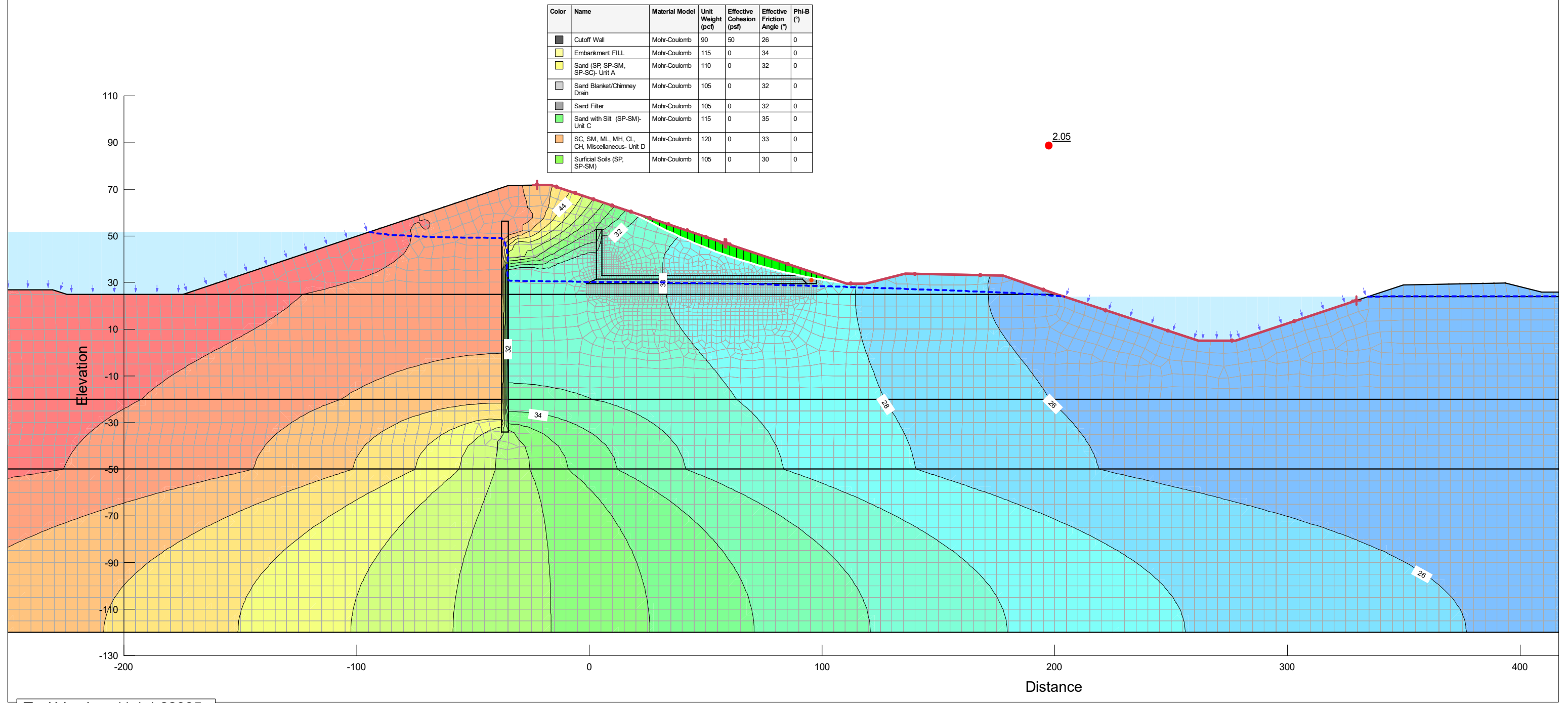


Figure A.8.8-6

LOCAR- Recommended Plan
 Typical Section B - Normal Pool
 Steady-State Upstream Slope
 Circular Failure/ Spencer

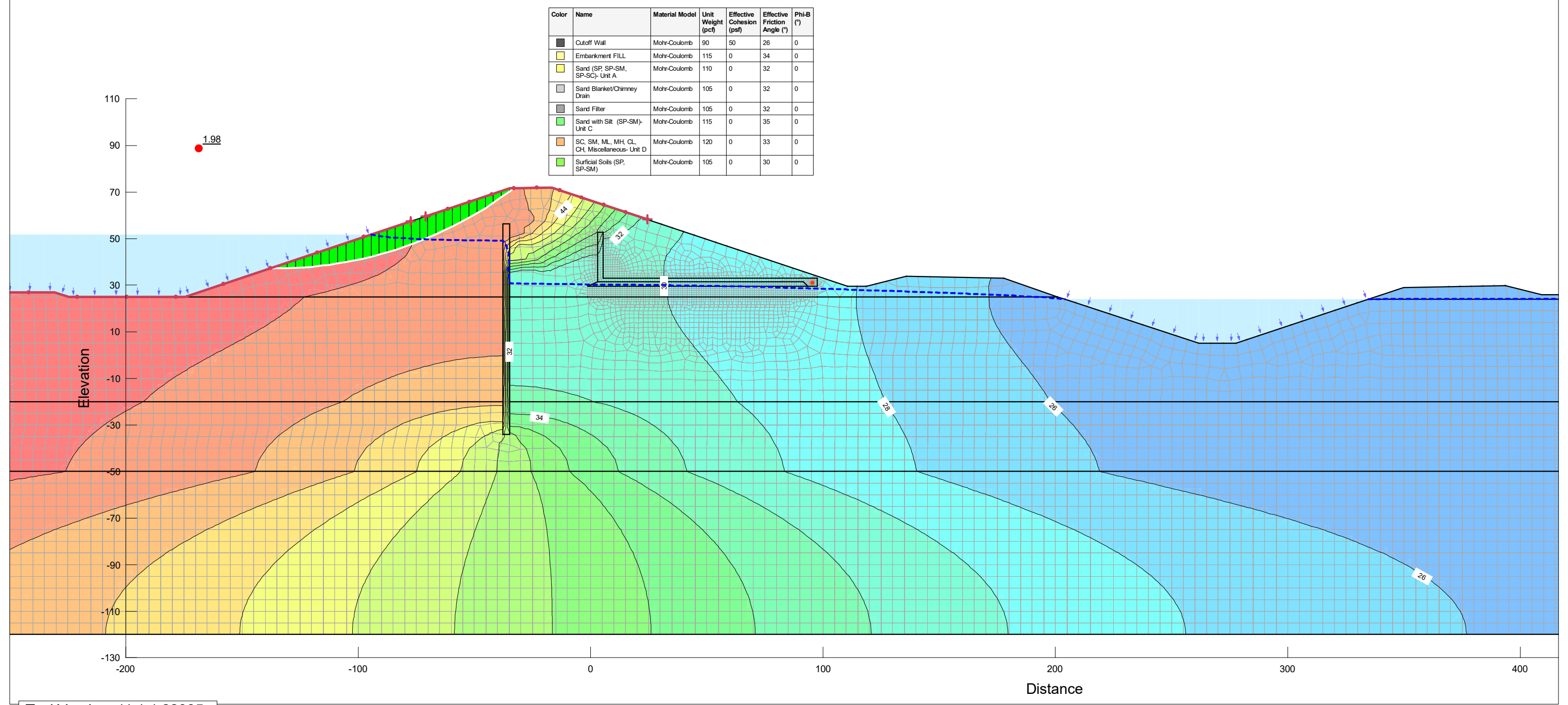


Figure A.8.8-7

LOCAR- Recommended Plan
 Typical Section B - PMF/PMP
 Steady-State Downstream Slope
 Circular Failure/ Spencer

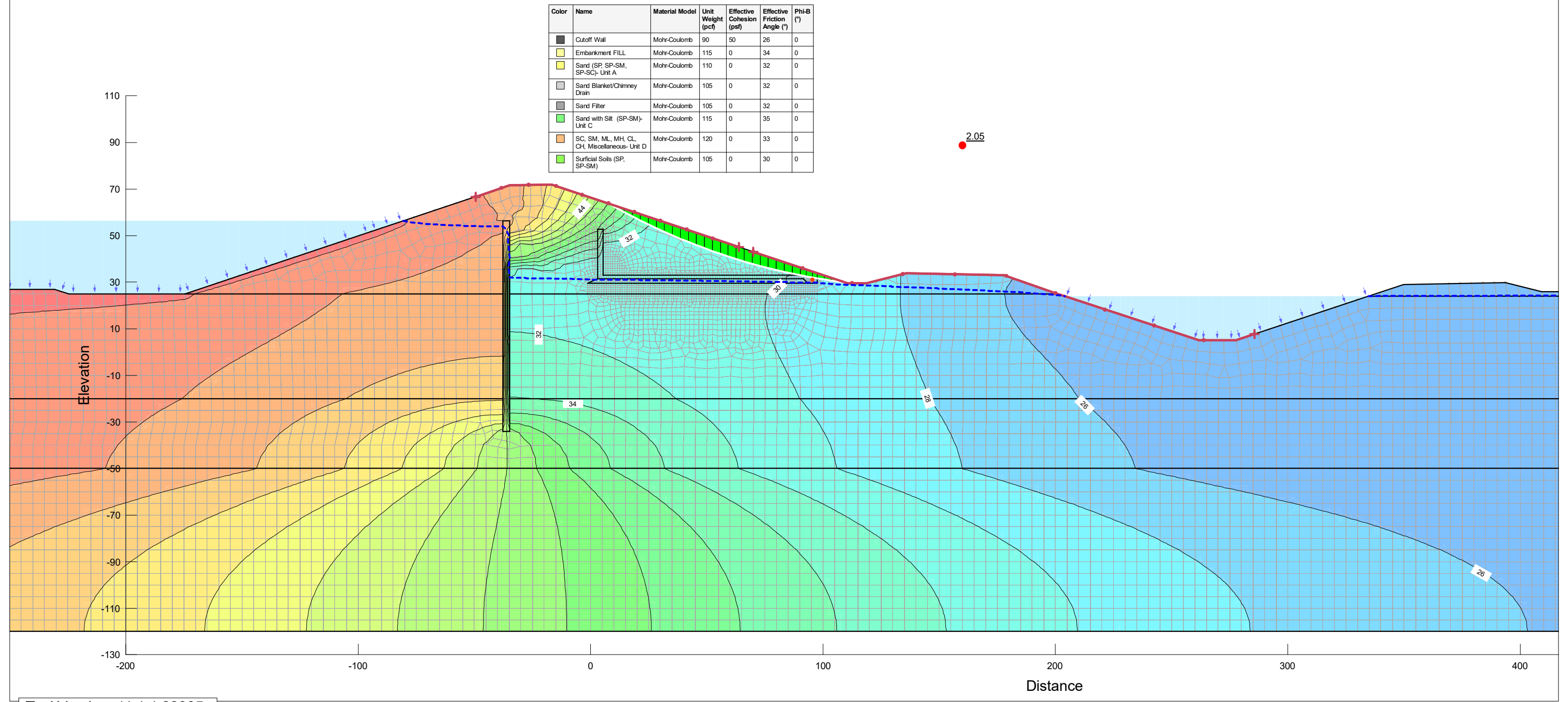


Figure A.8.8-8

LOCAR- Recommended Plan
 Typical Section B - PMF/PMP
 Steady-State Upstream Slope
 Circular Failure/ Spencer

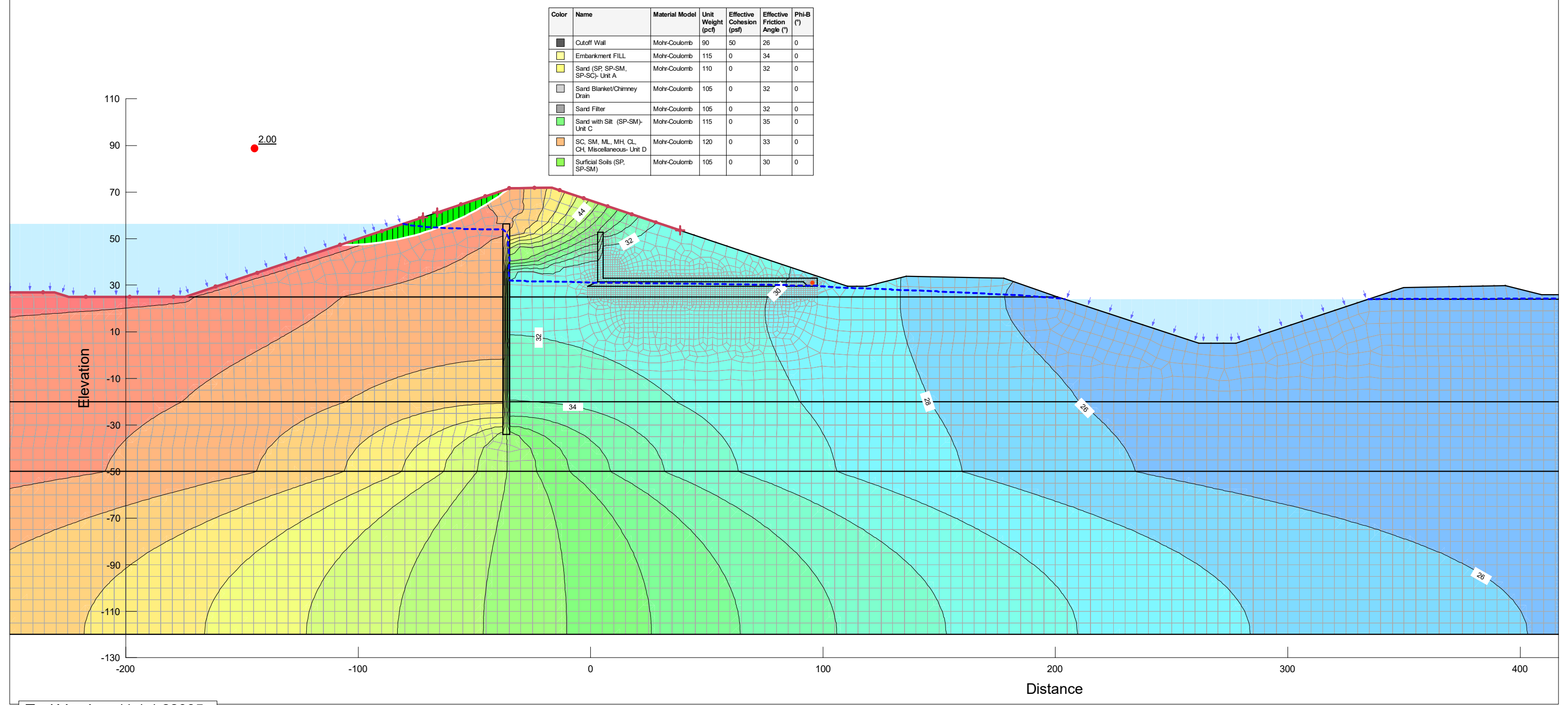


Figure A.8.8-9

LOCAR- Recommended Plan
 Typical Section C - Normal Pool
 Steady-State Downstream Slope
 Circular Failure/ Spencer

Color	Name	Material Model	Unit Weight (pcf)	Effective Cohesion (psf)	Effective Friction Angle (°)	Phi-B (°)
Black	Cutoff Wall	Mohr-Coulomb	90	50	26	0
Yellow	Embarkment FILL	Mohr-Coulomb	115	0	34	0
Light Yellow	Sand (SP, SP-SM, SP-SC)- Unit A	Mohr-Coulomb	110	0	32	0
Light Grey	Sand Blanket/Chimney Drain	Mohr-Coulomb	105	0	32	0
Dark Grey	Sand Filter	Mohr-Coulomb	105	0	32	0
Light Green	Sand with Silt (SP-SM)- Unit C	Mohr-Coulomb	115	0	35	0
Orange	SC, SM, ML, MH, CL, CH, Miscellaneous- Unit D	Mohr-Coulomb	120	0	33	0
Dark Green	Surficial Soils (SP, SP-SM)	Mohr-Coulomb	105	0	30	0

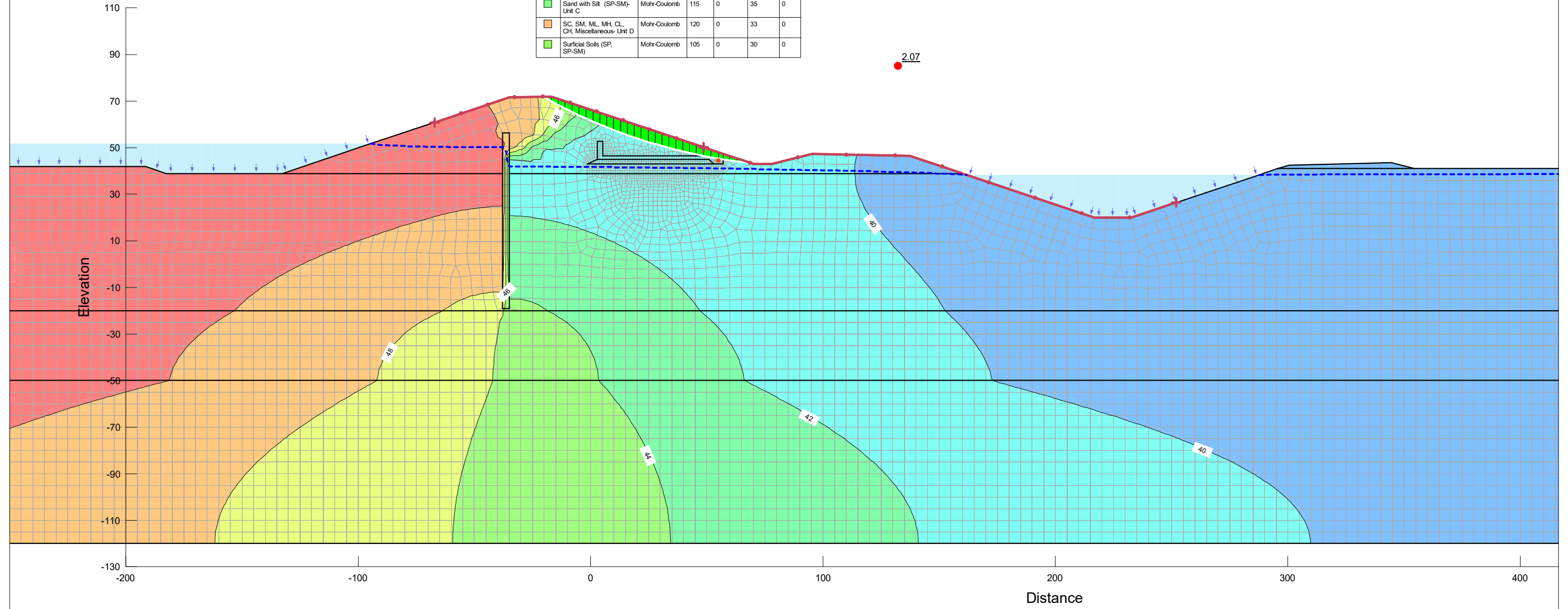


Figure A.8.8-10

LOCAR- Recommended Plan
 Typical Section C - Normal Pool
 Steady-State Upstream Slope
 Circular Failure/ Spencer

Color	Name	Material Model	Unit Weight (pcf)	Effective Cohesion (psf)	Effective Friction Angle (°)	Phi-B (°)
Black	Cutoff Wall	Mohr-Coulomb	90	50	26	0
Yellow	Embarkment FILL	Mohr-Coulomb	115	0	34	0
Light Yellow	Sand (SP, SP-SM, SP-SC)- Unit A	Mohr-Coulomb	110	0	32	0
Light Grey	Sand Blanket/Chimney Drain	Mohr-Coulomb	105	0	32	0
Dark Grey	Sand Filter	Mohr-Coulomb	105	0	32	0
Light Green	Sand with Silt (SP-SM)- Unit C	Mohr-Coulomb	115	0	35	0
Orange	SC, SM, ML, MH, CL, CH, Miscellaneous- Unit D	Mohr-Coulomb	120	0	33	0
Dark Green	Surficial Soils (SP, SP-SM)	Mohr-Coulomb	105	0	30	0

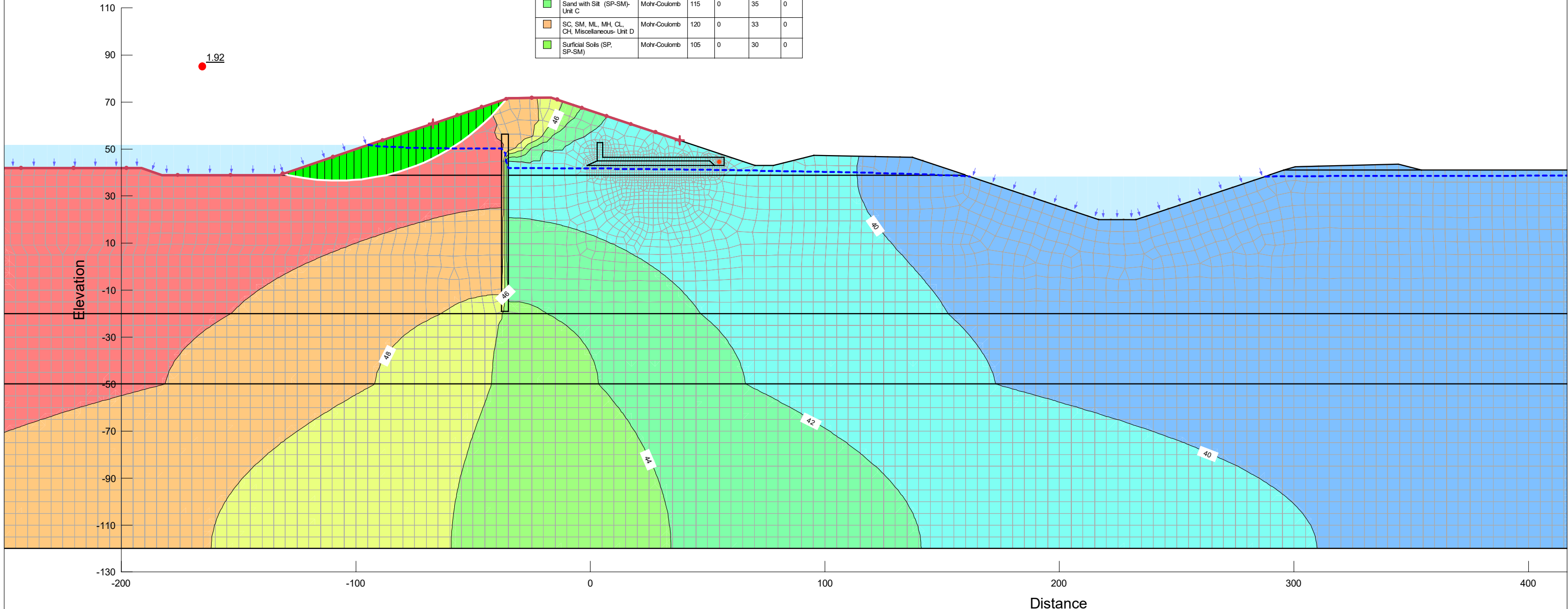


Figure A.8.8-11

LOCAR- Recommended Plan
 Typical Section C - PMF/PMP
 Steady-State Downstream Slope
 Circular Failure/ Spencer

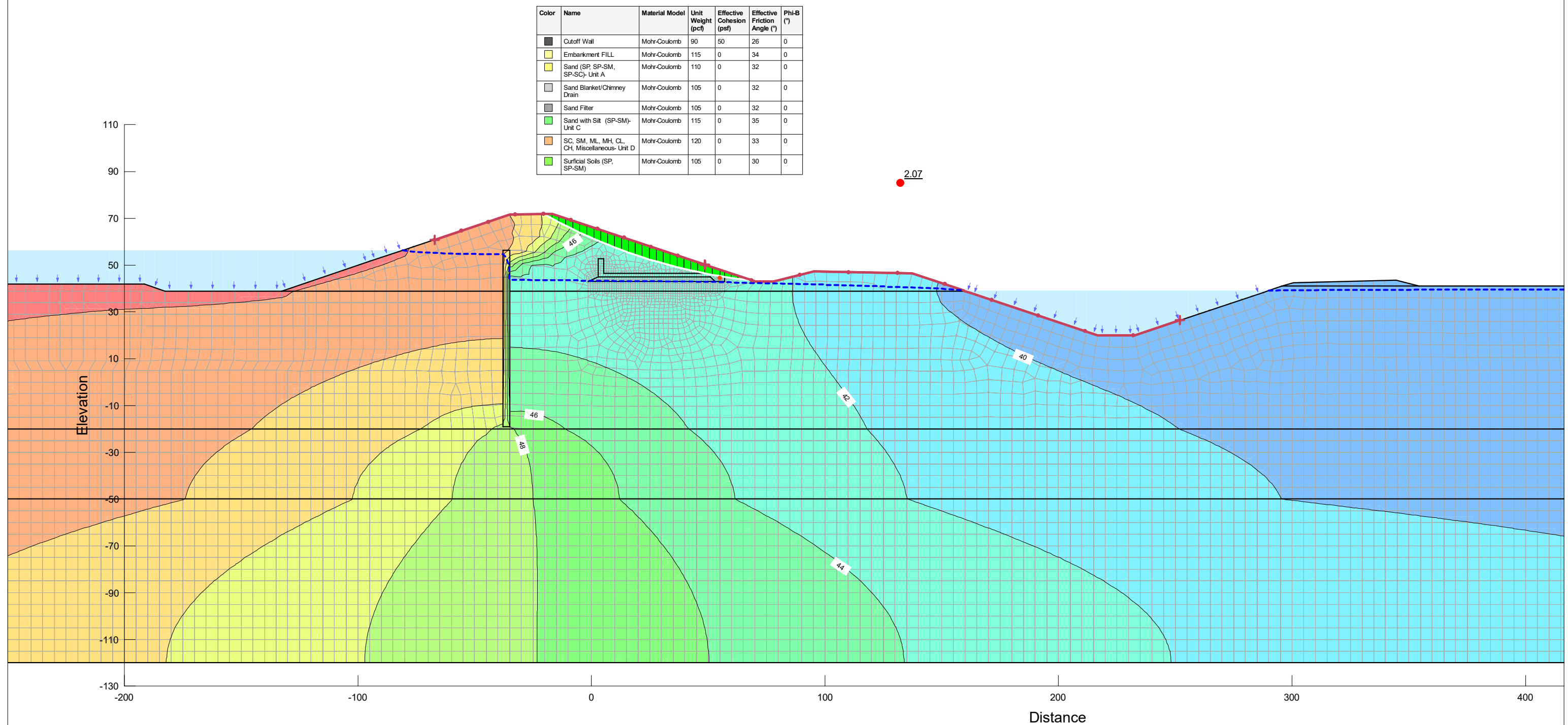


Figure A.8.8-12

LOCAR- Recommended Plan
 Typical Section C - PMF/PMP
 Steady-State Upstream Slope
 Circular Failure/ Spencer

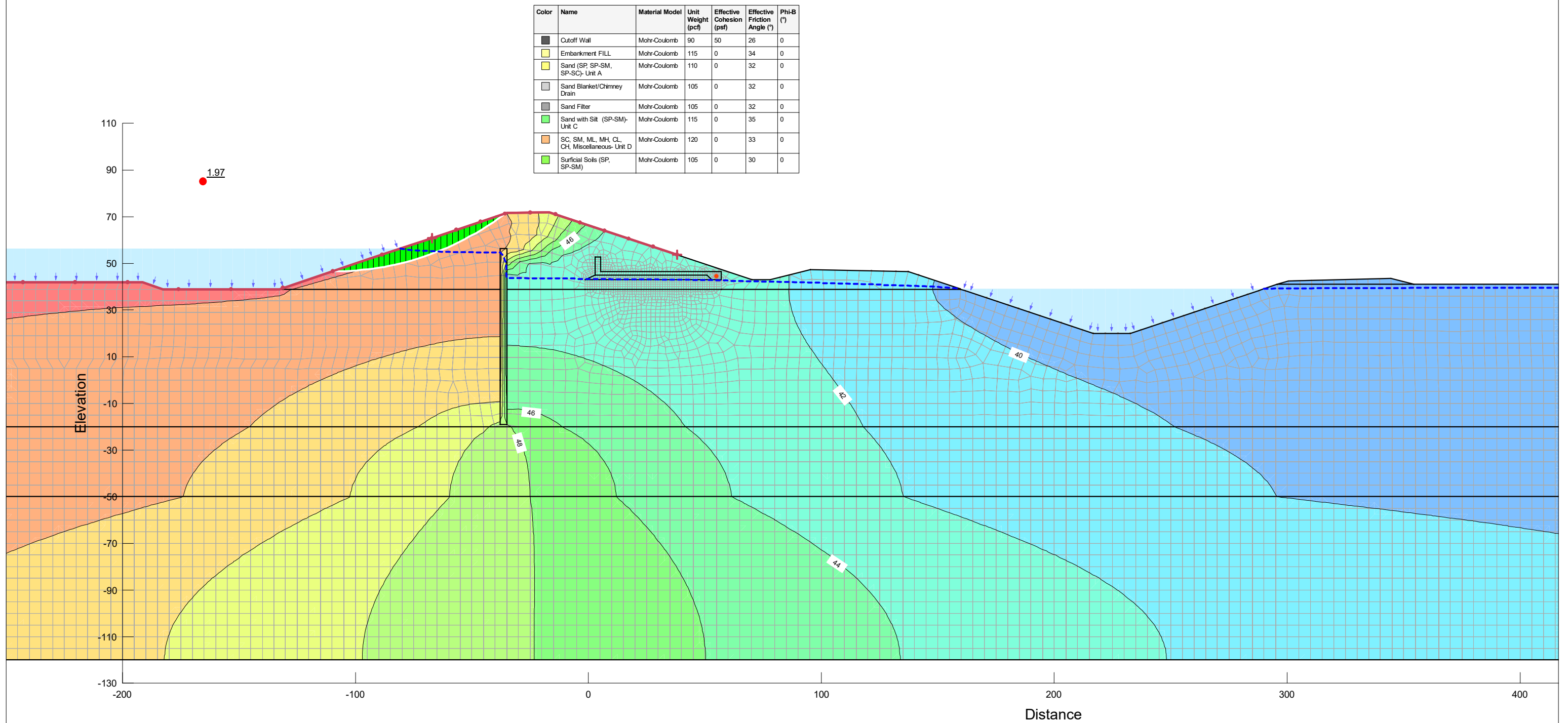


Figure A.8.8-13

LOCAR- Recommended Plan
 Typical Section D - Normal Pool
 Steady-State Downstream Slope
 Circular Failure/ Spencer

Color	Name	Material Model	Unit Weight (pcf)	Effective Cohesion (psf)	Effective Friction Angle (°)	Phi-B (°)
Grey	Cutoff Wall	Mohr-Coulomb	90	50	26	0
Yellow	Embankment FILL	Mohr-Coulomb	115	0	34	0
Light Green	Sand (SP, SP-SM, SP-SC)- Unit A	Mohr-Coulomb	110	0	32	0
Dark Green	Sand with Silt (SP-SM)- Unit C	Mohr-Coulomb	115	0	35	0
Orange	SC, SM, ML, MH, CL, CH, Miscellaneous- Unit D	Mohr-Coulomb	120	0	33	0

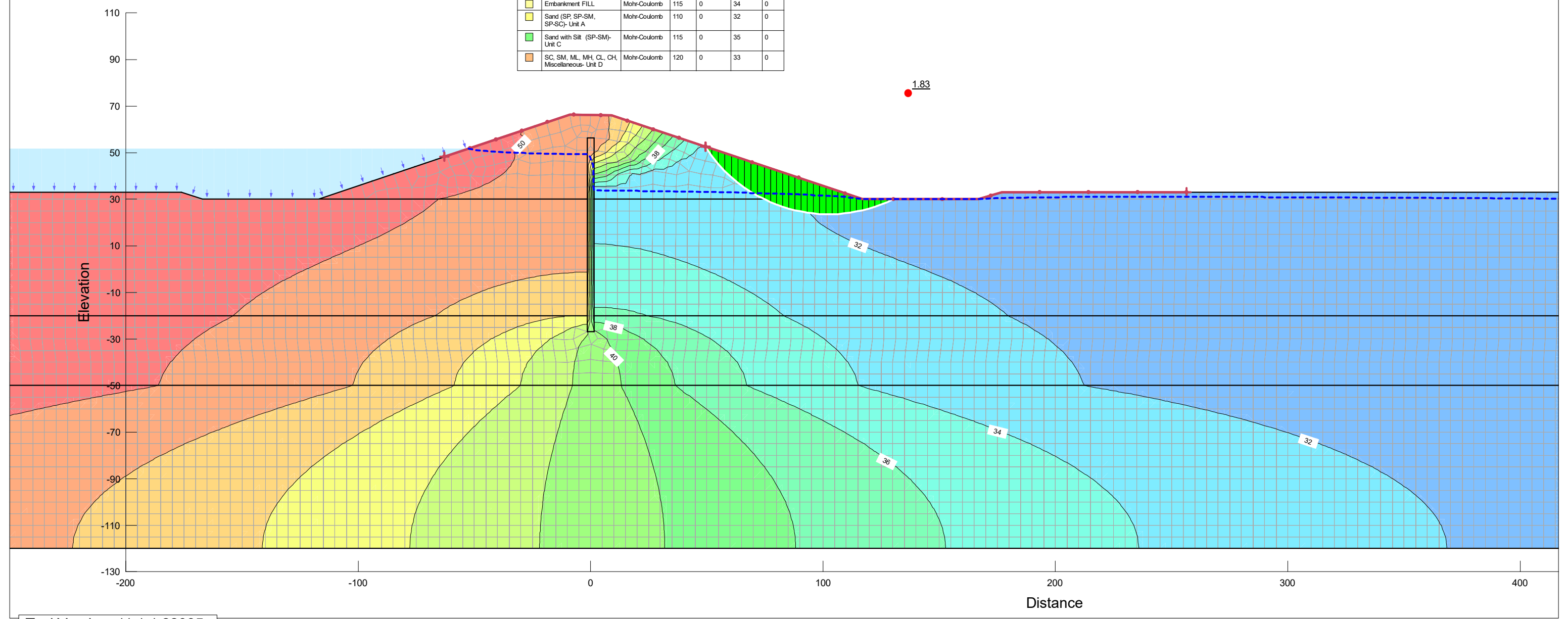
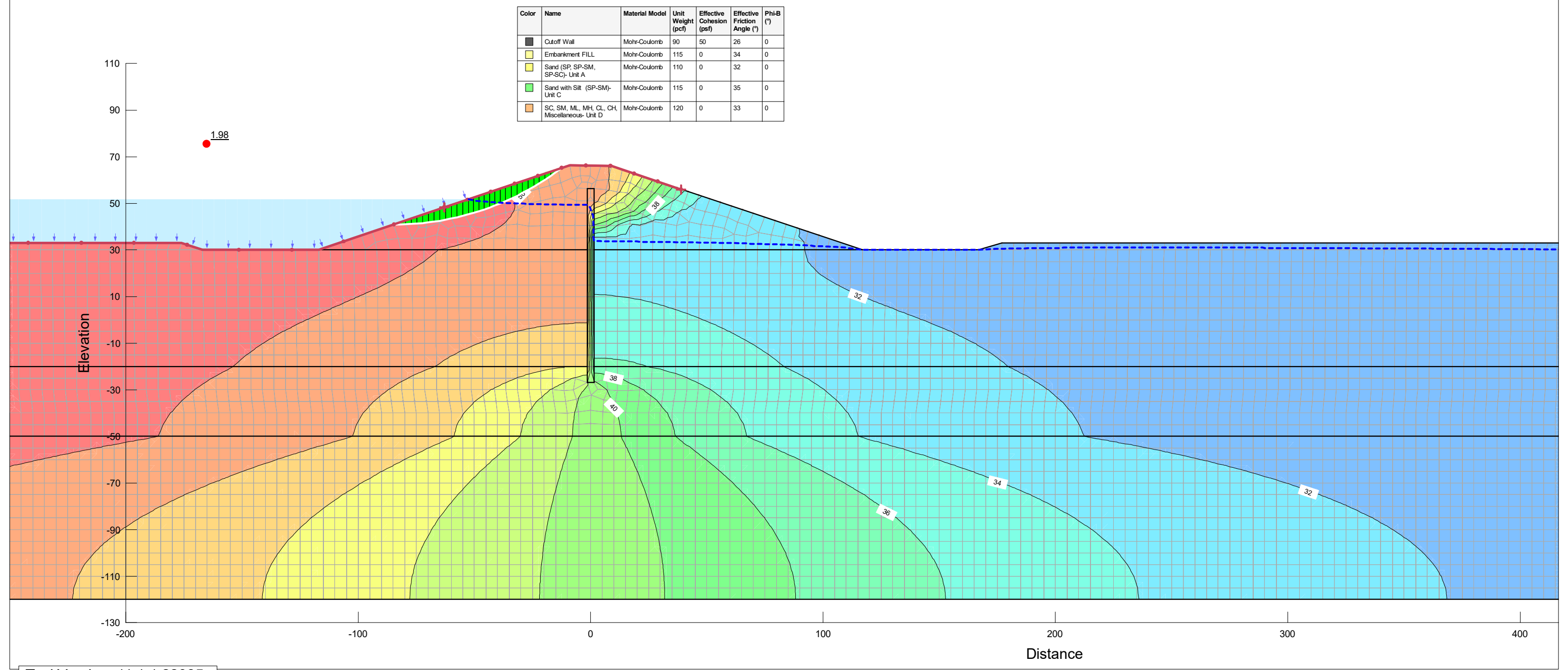


Figure A.8.8-14

LOCAR- Recommended Plan
 Typical Section D - Normal Pool
 Steady-State Upstream Slope
 Circular Failure/ Spencer



Color	Name	Material Model	Unit Weight (pcf)	Effective Cohesion (psf)	Effective Friction Angle (°)	Phi-B (°)
Black	Cutoff Wall	Mohr-Coulomb	90	50	26	0
Yellow	Embankment FILL	Mohr-Coulomb	115	0	34	0
Light Yellow	Sand (SP, SP-SM, SP-SC)- Unit A	Mohr-Coulomb	110	0	32	0
Light Green	Sand with Silt (SP-SM)- Unit C	Mohr-Coulomb	115	0	35	0
Orange	SC, SM, ML, MH, CL, CH, Miscellaneous- Unit D	Mohr-Coulomb	120	0	33	0

Figure A.8.8-15

LOCAR- Recommended Plan
 Typical Section D - PMF/PMP
 Steady-State Downstream Slope
 Circular Failure/ Spencer

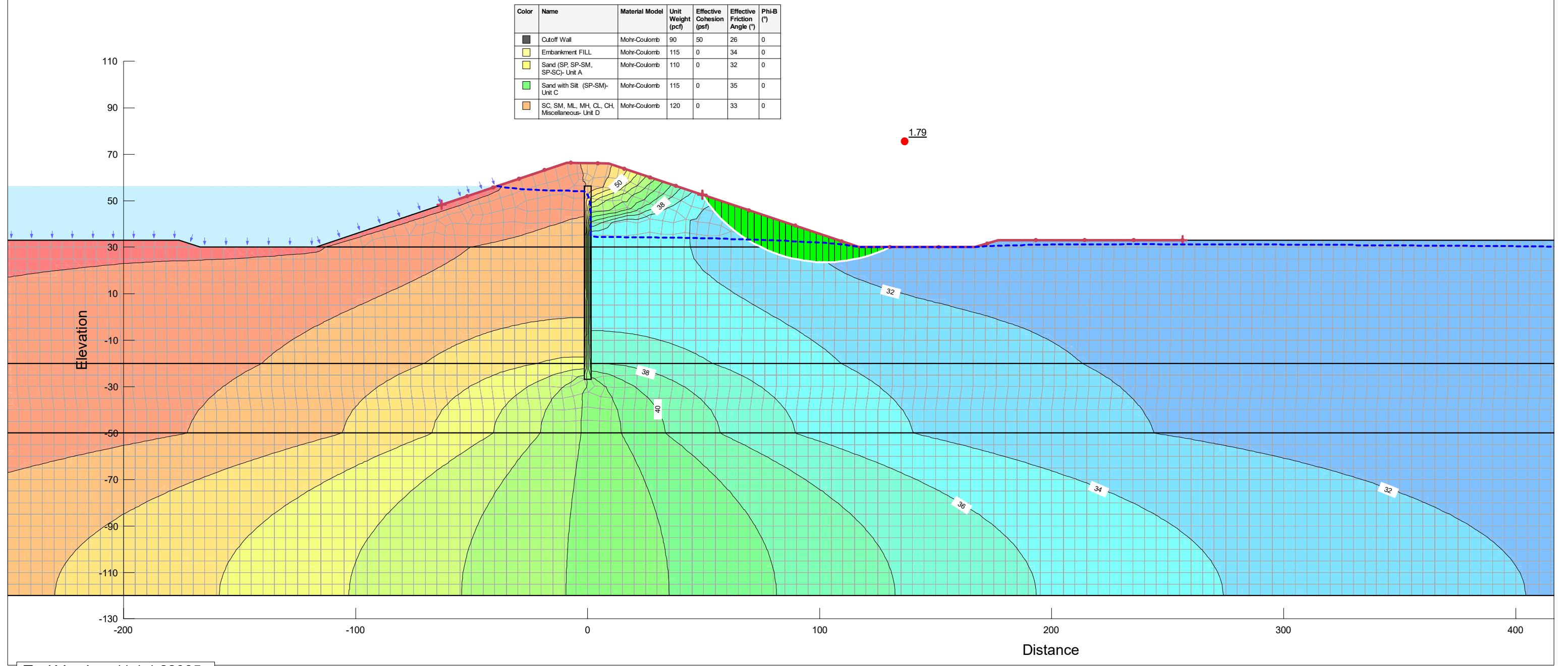


Figure A.8.8-16

LOCAR- Recommended Plan
 Typical Section D - PMF/PMP
 Steady-State Upstream Slope
 Circular Failure/ Spencer

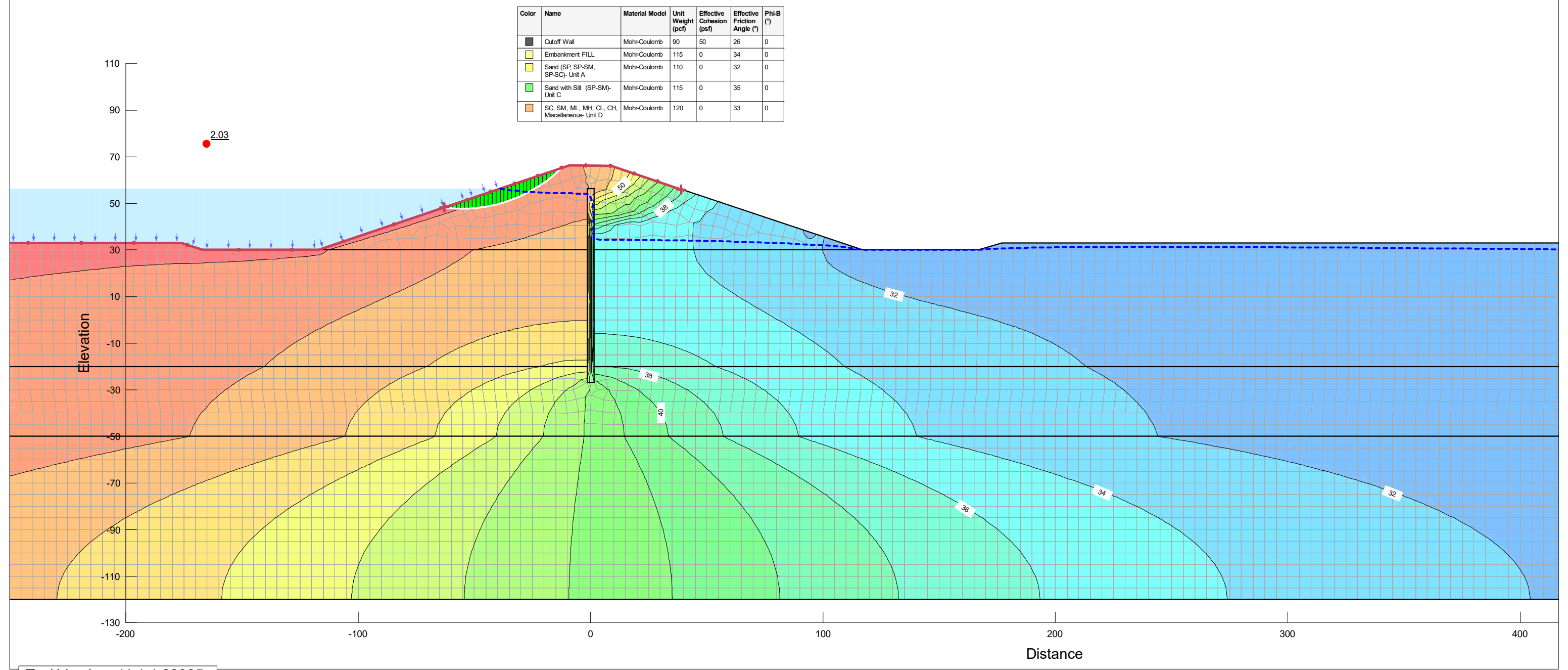


Figure A.8.8-17

LOCAR- Recommended Plan
 Typical Section A - Normal Pool
 Rapid Drawdown
 Circular Failure/ Spencer

Color	Name	Material Model	Unit Weight (pcf)	Effective Cohesion (psf)	Effective Friction Angle (°)	Phi-B (°)
Black	Cutoff Wall	Mohr-Coulomb	90	50	26	0
Yellow	Embankment FILL	Mohr-Coulomb	115	0	34	0
Light Yellow	Sand (SP, SP-SM, SP-SC)- Unit A	Mohr-Coulomb	110	0	32	0
Light Gray	Sand Blanket/Chimney Drain	Mohr-Coulomb	105	0	32	0
Dark Gray	Sand Filter	Mohr-Coulomb	105	0	32	0
Green	Sand with Silt (SP-SM)- Unit C	Mohr-Coulomb	115	0	35	0
Orange	SC, SM, ML, MH, CL, CH, Miscellaneous- Unit D	Mohr-Coulomb	120	0	33	0

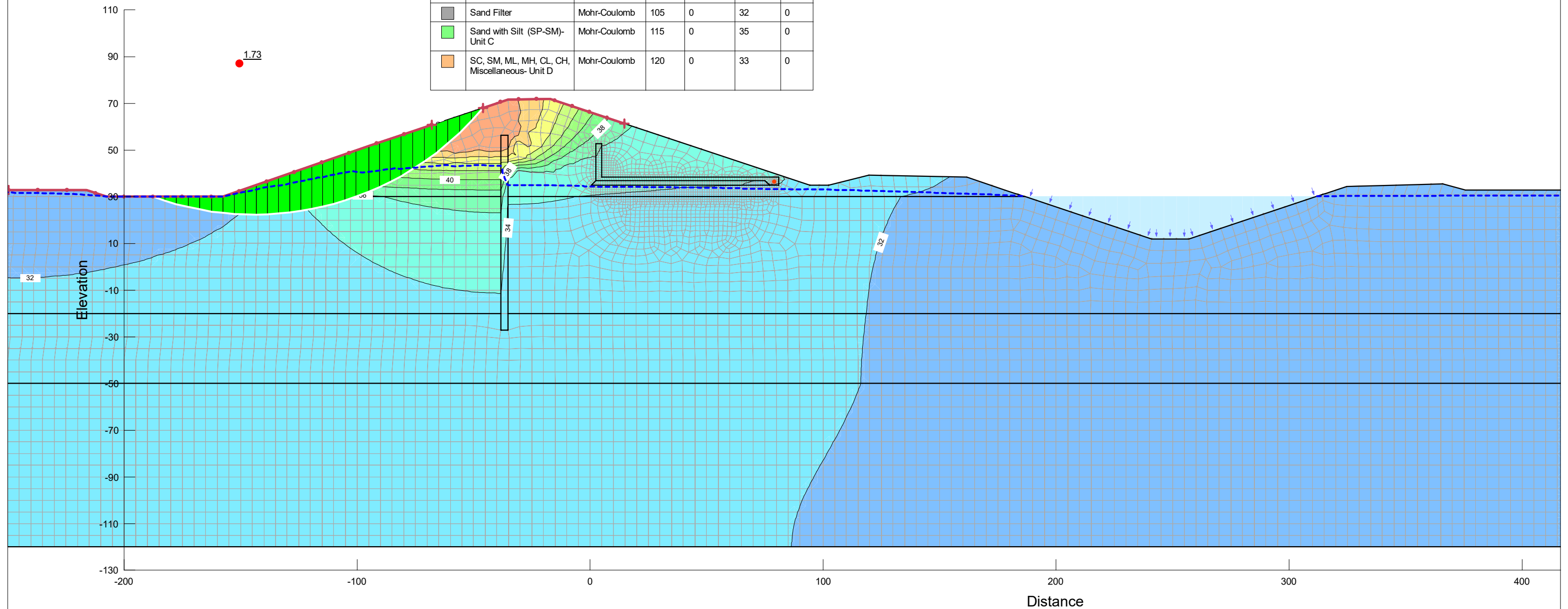


Figure A.8.8-18

LOCAR- Recommended Plan
 Typical Section A - PMF/PMP
 Rapid Drawdown
 Circular Failure/ Spencer

Color	Name	Material Model	Unit Weight (pcf)	Effective Cohesion (psf)	Effective Friction Angle (°)	Phi-B (°)
Black	Cutoff Wall	Mohr-Coulomb	90	50	26	0
Yellow	Embankment FILL	Mohr-Coulomb	115	0	34	0
Light Yellow	Sand (SP, SP-SM, SP-SC)- Unit A	Mohr-Coulomb	110	0	32	0
Light Gray	Sand Blanket/Chimney Drain	Mohr-Coulomb	105	0	32	0
Dark Gray	Sand Filter	Mohr-Coulomb	105	0	32	0
Green	Sand with Silt (SP-SM)- Unit C	Mohr-Coulomb	115	0	35	0
Orange	SC, SM, ML, MH, CL, CH, Miscellaneous- Unit D	Mohr-Coulomb	120	0	33	0

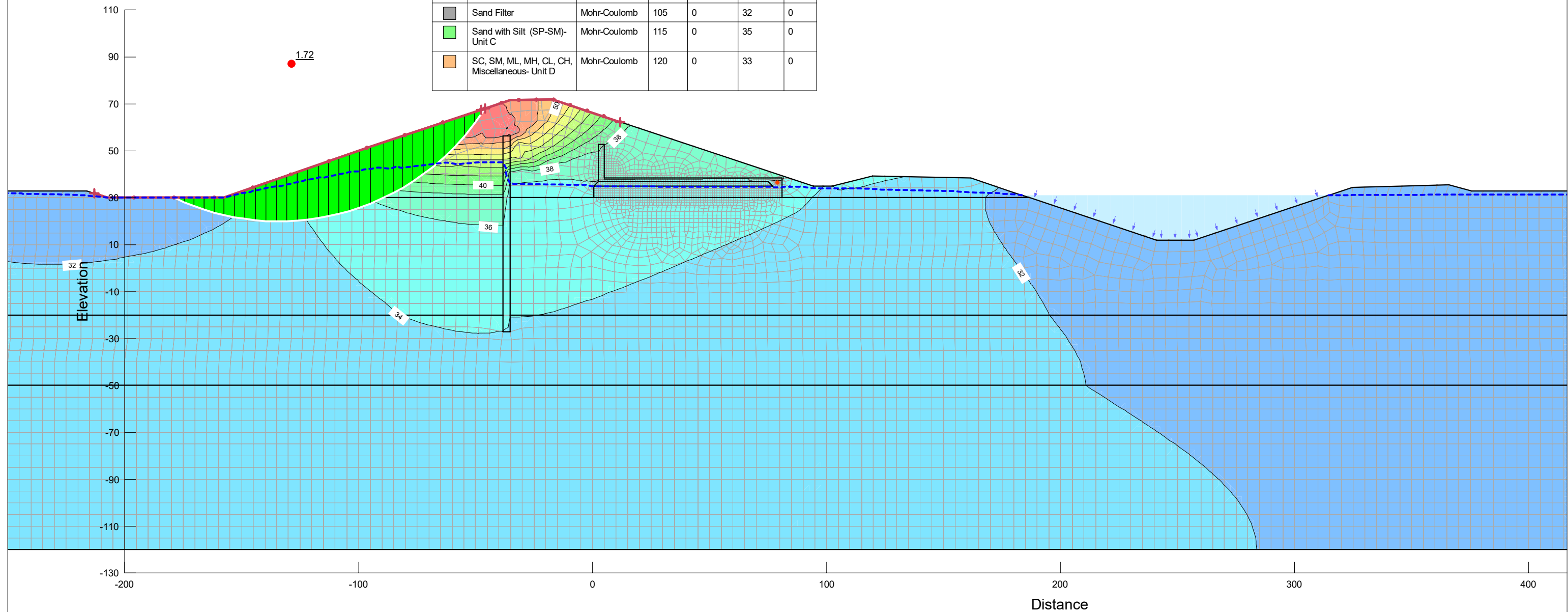


Figure A.8.8-19

LOCAR- Recommended Plan
 Typical Section B - Normal Pool
 Rapid Drawdown
 Circular Failure/ Spencer

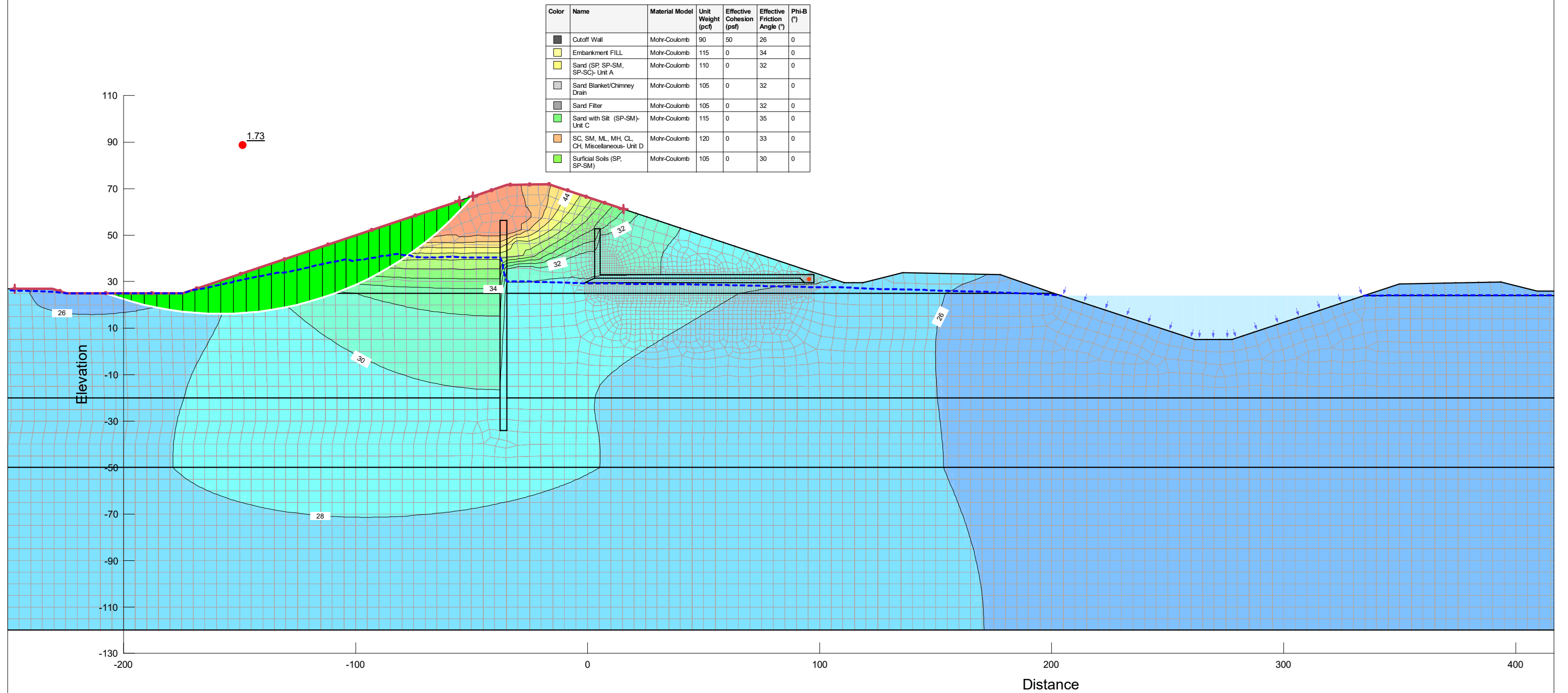


Figure A.8.8-20

LOCAR- Recommended Plan
 Typical Section B - PMF/PMP
 Rapid Drawdown
 Circular Failure/ Spencer

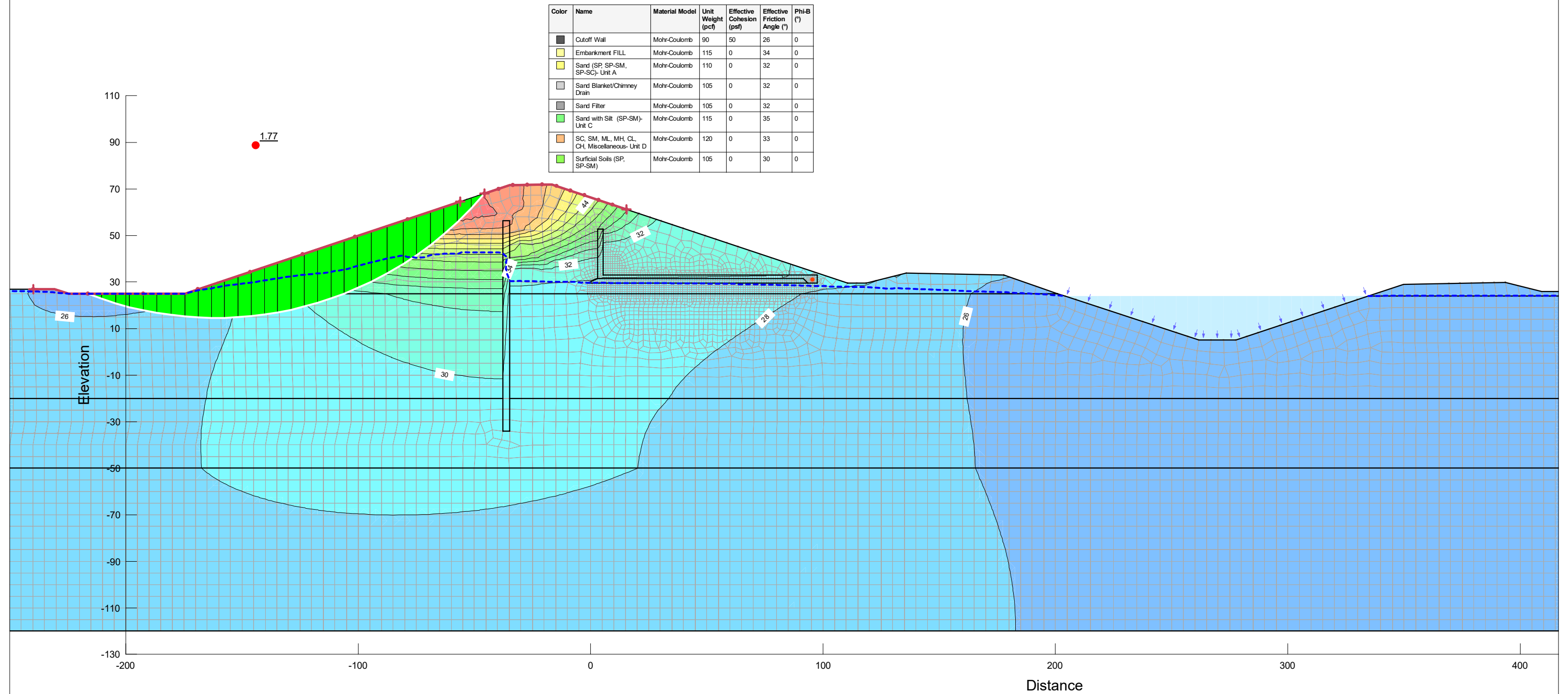


Figure A.8.8-21

LOCAR Alternative 1
 Typical Section C - Normal Pool
 Rapid Drawdown
 Circular Failure/ Spencer

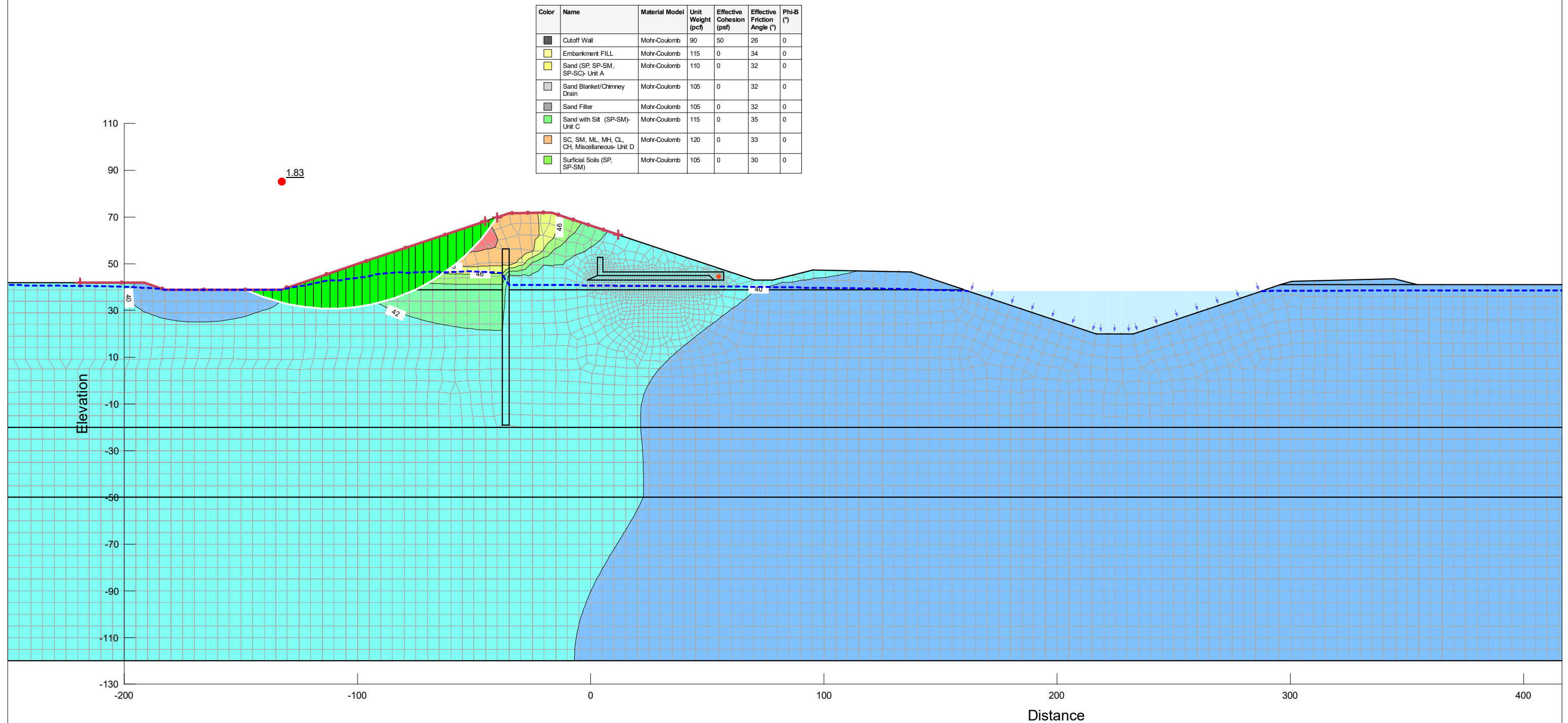


Figure A.8.8-23

LOCAR- Recommended Plan
 Typical Section D - Normal Pool
 Rapid Drawdown
 Circular Failure/ Spencer

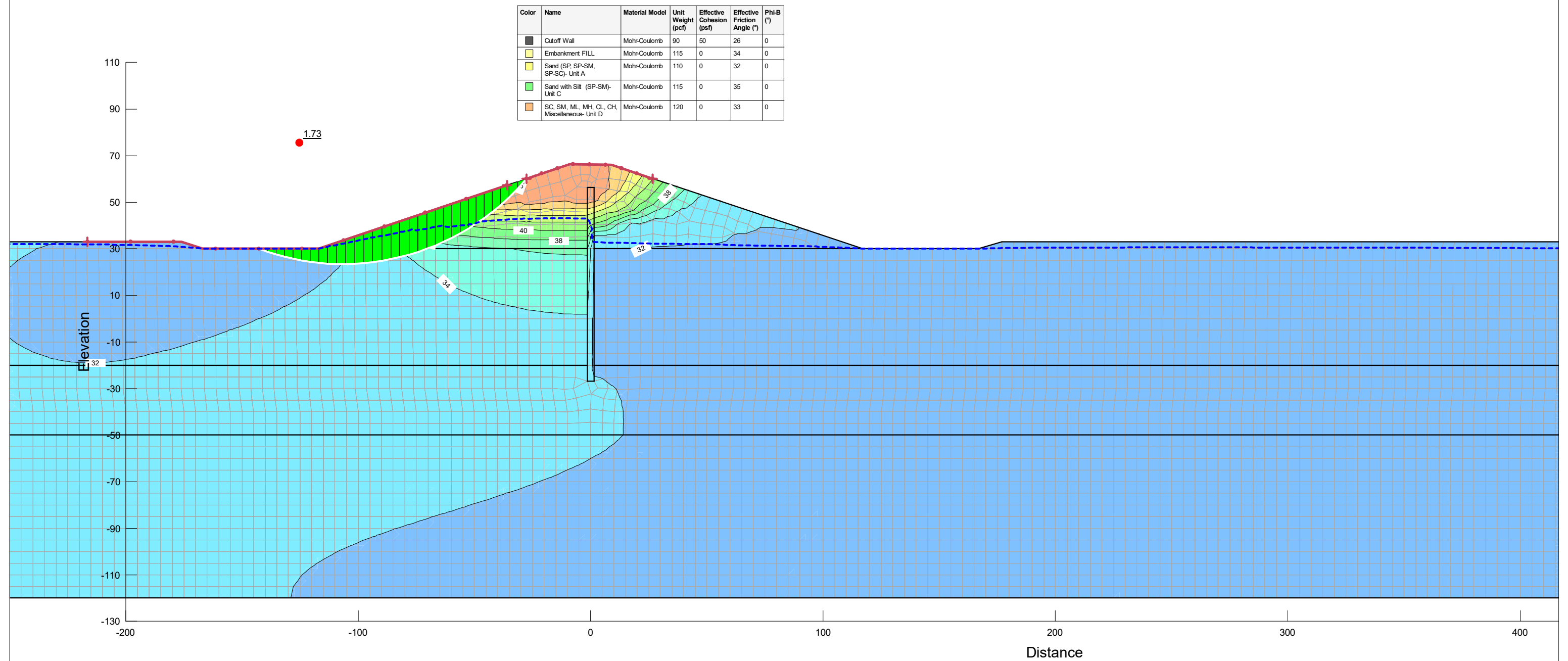


Figure A.8.8-24

LOCAR- Recommended Plan
 Typical Section D - PMF/PMP
 Rapid Drawdown
 Circular Failure/ Spencer

